

Catalog Number DOC022.53.00725

DR 2800 Spectrophotometer

PROCEDURES MANUAL

June 2007 Edition 2

Important Note:

*All procedures are available on the DR 2700 with the following exceptions:
Chlorine Dioxide Method 8345, Direct Reading Method, MR
COD Method 8000, Reactor Digestion Method, ULR (0.7 to 40.0)
TNTplus procedures*

Table of Contents

★ Denotes USEPA accepted or approved for water or wastewater analysis.

Method Precision Data	1
Working with Chemical Procedures	9
Alachlor	
Method 10202 Immunoassay Method	
Aluminum	
Method 8012 Aluminon Method Powder Pillows	(0.008 to 0.800 mg/L)
Aluminum	
Method 8326 Eriochrome Cyanine R Method Powder Pillows	(0.002 to 0.250 mg/L Al ³⁺)
Aluminum	
Method 10215 Chromazurol S Method TNTplus™ 848	(0.02 to 0.50 mg/L Al)
Arsenic	
MMethod 8013 Silver Diethyldithiocarbamate Method	(0 to 0.200 mg/L As)
Atrazine	
Method 10050 Immunoassay Method	
Barium	
★ Method 8014 Turbidimetric Method Powder Pillows	(2 to 100 mg/L)
Benzotriazole/Tolyltriazole	
Method 8079 UV Photolysis Method Powder Pillows	(Benzotriazole 1.0 to 16.0 mg/L, Tolyltriazole 1.0 to 20.0 mg/L)
Boron	
Method 10061 Azomethine-H Method Powder Pillows	LR (0.02 to 1.50 mg/L as B)
Boron	
Method 8015 Carmine Method Powder Pillows	(0.2 to 14.0 mg/L)
Bromine	
Method 8016 DPD Method Powder Pillows or AccuVac® Ampuls	(0.05 to 4.50 mg/L)
Cadmium	
Method 8017 Dithizone Method Powder Pillows	(0 to 80.0 µg/L)
Cadmium	
Method 10217 Cadion Method TNTplus™ 852	(0.02 to 0.30 mg/L Cd)
Chloramine (Mono)	
Method 10172 Indophenol Method	HR (0.1 to 10.0 mg/L Cl ₂)
Chloramine (Mono)	
Method 10171 Indophenol Method Powder Pillows	LR (0.04 to 4.50 mg/L Cl ₂)
Chloramine (Mono); Nitrogen, Free Ammonia	
Method 10200 Indophenol Method Powder Pillows	(0.01–0.50 mg/L NH ₃ -N; 0.04–4.50 mg/L Cl ₂)
Chloride	
Method 8113 Mercuric Thiocyanate Method	(0.1 to 25.0 mg/L Cl ⁻)
Chlorine Dioxide	
Method 8138 Direct Reading Method	HR (5 to 1000 mg/L)

Table of Contents

★ Denotes USEPA accepted or approved for water or wastewater analysis.

Chlorine Dioxide

Method 8065 Chlorophenol Red Method LR (0.01 to 1.00 mg/L)

Chlorine Dioxide

Amaranth Method (20 to 500 µg/L)

Chlorine Dioxide

Method 8345 Direct Reading Method MR (1–50 mg/L)

Chlorine Dioxide

★ Method 10126 DPD Method Powder Pillows and AccuVac® Ampuls (0.04 to 5.00 mg/L)

Chlorine, Free

★ Method 8021 DPD Method Powder Pillows or AccuVac® Ampuls (0.02 to 2.00 mg/L)

Chlorine, Free

Method 10102 DPD Method Test 'N Tube™ Vials (0.09 to 5.00 mg/L)

Chlorine, Free

Method 10059 DPD Rapid Liquid Method Pour-Thru™ Cell (0.02 to 2.00 mg/L)

Chlorine, Free

Method 10069 DPD Method Powder Pillows HR (0.1 to 10.0 mg/L as Cl₂)

Chlorine, Total

★ Method 8167 DPD Method Powder Pillows or AccuVac® Ampuls (0.02 to 2.00 mg/L)

Chlorine, Total

Method 10070 DPD Method Powder Pillows HR (0.1 to 10.0 mg/L as Cl₂)

Chlorine, Total

Method 10101 DPD Method Test 'N Tube™ Vials (0.09 to 5.00 mg/L)

Chlorine, Total

Method 10060 DPD Rapid Liquid Method Pour-Thru Cell (0.02 to 2.00 mg/L)

Chlorine, Total

★ Method 8370 DPD Method Pour-Thru™ Cell ULR (2 to 500 µg/L as Cl₂)

Chlorine, Total

★ Method 10014 DPD Method Pour-Thru Cell and OriFlo™ Filtration ULR (2 to 500 µg/L as Cl₂)

Chromium, Hexavalent

★ Method 8023 1,5-Diphenylcarbohydrazide Method Powder Pillows or AccuVac® Ampuls (0.010 to 0.700 mg/L Cr⁶⁺)

Chromium, Total

Method 8024 Alkaline Hypobromite Oxidation Method, Powder Pillows (0.01 to 0.70 mg/L)

Chromium, Total and Hexavalent

Method 10218 (Chromium, Hexavalent)
Method 10219 (Chromium, Total) 1,5-Diphenylcarbohydrazide Method TNTplus™ 854 (0.03 to 1.00 mg/L Cr)

Cobalt

Method 8078 1-(2-Pyridylazo)-2-Naphthol (PAN) Method Powder Pillows (0.01 to 2.00 mg/L)

Color, True and Apparent

Method 8025 Platinum-Cobalt Standard Method, (15 to 500 units)

★ Denotes USEPA accepted or approved for water or wastewater analysis.

Copper

Method 8143 Porphyrin Method Powder Pillows LR (1 to 210 µg/L)

Copper

★Method 8506 and Method 8026 Bicinchoninate Method Powder Pillows or AccuVac® Ampuls (0.04 to 5.00 mg/L)

Cyanide

Method 8027 Pyridine-Pyrazalone Method Powder Pillows (0.002 to 0.240 mg/L CN⁻)

Cyanuric Acid

Method 8139 Turbidimetric Method Powder Pillows (5 to 50 mg/L)

Fluoride

★Method 8029 SPADNS Method Reagent Solution or AccuVac® Ampuls (0.02 to 2.00 mg/L F⁻)

Formaldehyde

Method 8110 MBTH Method Powder Pillows (3 to 500 µg/L)

Hardness

Method 8030 Calcium and Magnesium; Calmagite Colorimetric Method (0.05 to 4.00 mg/L Ca and Mg as CaCO₃)

Hardness

Method 8374 Calcium and Magnesium; Chlorophosponazo Colorimetric Method (8 to 1000 µg/L Ca and Mg as CaCO₃)

Hardness, Total

Method 8374 Calcium and Magnesium; Chlorophosponazo Rapid Liquid Method Pour-Thru Cell ULR (4 to 1000 µg/L Ca & Mg as CaCO₃)

Hydrazine

Method 8141 p-Dimethylaminobenzaldehyde Method Reagent Solution or AccuVac® Ampuls (4 to 600 µg/L)

Iodine

Method 8031 DPD Method Powder Pillows or AccuVac® Ampuls (0.07 to 7.00 mg/L)

Iron

Method 8147 FerroZine® Method FerroZine® Reagent Solution Pillows (0.009 to 1.400 mg/L)

Iron, Ferrous

Method 8146 1, 10 Phenanthroline Method Powder Pillows or AccuVac® Ampuls (0.02 to 3.00 mg/L)

Iron

Method 8147 FerroZine® Rapid Liquid Method* Pour-Thru Cell (0.009 to 1.400 mg/L Fe)

Iron, Total

Method 8112 TPTZ Method Powder Pillows or AccuVac® Ampuls (0.012 to 1.800 mg/L)

Iron, Total

Method 8365 FerroMo Method Powder Pillows (0.01 to 1.80 mg/L)

Iron, Total

★Method 8008 FerroVer® Method Powder Pillows or AccuVac® Ampuls (0.02 to 3.00 mg/L)

Lead

Method 8317 LeadTrak® Fast Column Extraction Method (5 to 150 µg/L)

Lead

Table of Contents

★ Denotes USEPA accepted or approved for water or wastewater analysis.

★ Method 8033 Dithizone Method Powder Pillows (3 to 300 µg/L)

Lead

Method 10216 PAR Method TNTplus™ 850 (0.1 to 2.0 mg/L Pb)

Manganese

Method 8149 1-(2-Pyridylazo)-2-Naphthol PAN Method Powder Pillows LR (0.006 to 0.700 mg/L)

Manganese

★ Method 8034 Periodate Oxidation Method Powder Pillows HR (0.1 to 20.0 mg/L)

Mercury

Method 10065 Cold Vapor Mercury Concentration Method (0.1 to 2.5 µg/L)

Molybdenum, Molybdate

Method 8036 Mercaptoacetic Acid Method Powder Pillows or AccuVac® Ampuls HR (0.2 to 40.0 mg/L)

Molybdenum, Molybdate

Method 8169 Ternary Complex Method Powder Pillows (0.02 to 3.00 mg/L)

Nickel

Method 8150 1-(2 Pyridylazo)-2-Naphthol (PAN) Method Powder Pillows (0.006 to 1.000 mg/L)

Nickel

★ Method 8037 Heptoxime Method Powder Pillows (0.02 to 1.80 mg/L Ni)

Nickel

Method 10220 Dimethylglyoxime Method TNTplus™ 856 (0.1 to 6.0 mg/L Ni)

Nitrate

Method 8039 Cadmium Reduction Method Powder Pillows or AccuVac® Ampuls HR (0.3 to 30.0 mg/L NO₃⁻-N)

Nitrate

Method 8192 Cadmium Reduction Method Powder Pillows LR (0.01 to 0.50 mg/L NO₃⁻-N)

Nitrate

Method 10020 Chromotropic Acid Method Test 'N Tube™ Vials HR (0.2 to 30.0 mg/L NO₃⁻-N)

Nitrate

Method 10206 Dimethylphenol Method TNTplus 836 HR (5–35 mg/L NO₃⁻-N or 22–155 mg/L NO₃)

Nitrate

Method 10206 Dimethylphenol Method TNTplus 835 LR (0.23 to 13.50 mg/L NO₃⁻-N or 1.00 to 60.00 mg/L NO₃)

Nitrate

Method 8171 Cadmium Reduction Method Powder Pillows or AccuVac® Ampuls MR (0.1 to 10.0 mg/L NO₃⁻-N)

Nitrite

Method 10019 Diazotization Method Test 'N Tube™ Vials LR (0.003 to 0.500 mg/L NO₂⁻-N)

Nitrite

★ Method 8507 Diazotization Method Powder Pillows or AccuVac® Ampuls LR (0.002 to 0.300 mg/L NO₂⁻-N)

Nitrite

Method 8153 Ferrous Sulfate Method Powder Pillows HR (2 to 250 mg/L NO₂⁻)

Nitrite

★ Method 10207 Diazotization Method TNTplus™ 839LR (0.015 to 0.600 mg/L NO₂⁻-N or 0.05 to 2.00 mg/L NO₂)

Nitrogen, Ammonia

★ Denotes USEPA accepted or approved for water or wastewater analysis.

Method 8155 Salicylate Method Powder Pillows	(0.01 to 0.50 mg/L NH ₃ -N)
Nitrogen, Ammonia	
★ Method 8038 Nessler Method	(0.02 to 2.50 mg/L NH ₃ -N)
Nitrogen, Ammonia	
Method 10031 Salicylate Method Test 'N Tube™ Vials	HR (0.4 to 50.0 mg/L NH ₃ -N)
Nitrogen, Ammonia	
Method 10023 Salicylate Method Test 'N Tube™ Vials	LR (0.02 to 2.50 mg/L NH ₃ -N)
Nitrogen, Ammonia	
Method 10205 Salicylate Method TNTplus™ 830	ULR (0.015 to 2.000 mg/L NH ₃ -N)
Nitrogen, Ammonia	
Method 10205 Salicylate Method TNTplus™ 831	LR (1 to 12 mg/L NH ₃ -N)
Nitrogen, Ammonia	
Method 10205 Salicylate Method TNTplus™ 832	HR (2 to 47 mg/L NH ₃ -N)
Nitrogen, Free Ammonia	
Method 10201 Indophenol Method Powder Pillows	(0.01 to 0.50 mg/L NH ₃ -N)
Nitrogen, Total	
Method 10072 Persulfate Digestion Method Test 'N Tube™ Vials	HR (2 to 150 mg/L N)
Nitrogen, Total	
Method 10071 Persulfate Digestion Method Test 'N Tube™ Vials	LR (0.5 to 25.0 mg/L N)
Nitrogen, Total	
Method 10208 Persulfate Digestion Method TNTplus™ 826	LR (1 to 16 mg/L N)
Nitrogen, Total	
Method 10208 Persulfate Digestion Method TNTplus™ 827	HR (5 to 40 mg/L N)
Nitrogen, Total	
Method 10208 Persulfate Digestion Method TNTplus™ 828	UHR (20 to 100 mg/L N)
Nitrogen, Total Inorganic	
Method 10021 Titanium Trichloride Reduction Method Test 'N Tube™ Vials	(0.2 to 25.0 mg/L N)
Nitrogen, Total Kjeldahl	
Method 8075 Nessler Method (Digestion Required)	(1 to 150 mg/L)
Organic Carbon, Total	
Method 10129 Direct Method	LR (0.3 to 20.0 mg/L C)
Organic Carbon, Total	
Method 10173 Direct Method	MR (15 to 150 mg/L C)
Organic Carbon, Total	
Method 10128 Direct Method	HR (100 to 700 mg/L C)
Oxygen, Dissolved	
★ Method 8166 HRDO Method AccuVac® Ampuls	HR (0.3 to 15.0 mg/L O ₂)
Oxygen, Dissolved	
Method 8333 Ultra High Range Method AccuVac® Ampul	UHR (1.0 to 40.0 mg/L O ₂)
Oxygen, Dissolved	

Table of Contents

★ Denotes USEPA accepted or approved for water or wastewater analysis.

Method 8316 Indigo Carmine Method AccuVac® Ampuls LR (6 to 800 µg/L O₂)

Oxygen Demand, Chemical

★ Method 8000 Reactor Digestion Method TNTplus™ LR (TNT821, 3–150 COD);
HR (TNT822, 20–1500mg/L COD)

Oxygen Demand, Chemical

★ Method 8000 Reactor Digestion Method (0.7 to 40.0, 3 to 150, 20 to 1500 and
200 to 15,000 mg/L COD)

Oxygen Demand, Chemical

Method 10067 Manganese III Reactor Digestion Method (with optional chloride removal) (30 to 1000 mg/L COD
Mn)

Oxygen Demand, Chemical

Method 10067 Manganese III Reactor Digestion Method (without chloride removal) (30 to 1000 mg/L COD Mn)

Oxygen Demand, Chemical

★ Method 10211 Reactor Digestion Method TNTplus™ 820 ULR (1–60 mg/L COD)

Oxygen Demand, Chemical

★ Method 10212 Reactor Digestion Method TNTplus™ 823 UHR (250–15,000 mg/L COD)

Oxygen Scavengers

Method 8140 Iron Reduction Method for Oxygen Scavengers Powder Pillows

Ozone

Method 8311 Indigo Method AccuVac® Ampul

PCB (Polychlorinated Biphenyls)

Method 10050 Immunoassay Method

Phenols

★ Method 8047 4-Aminoantipyrine Method (0.002 to 0.200 mg/L)

Phosphonates

Method 8007 Persulfate UV Oxidation Method Powder Pillows (0.02 to 2.50 and 1.0 to 125.0 mg/L)

Phosphorus, Acid Hydrolyzable Digestion

★ Method 8180 Acid Digestion Method

Phosphorus, Acid Hydrolyzable

Method 8180 PhosVer™ 3 with Acid Hydrolysis Method Test 'N Tube™ Vials (0.06 to 3.50 mg/L PO₄³⁻)

Phosphorus, Total, Digestion

★ Method 8190 Acid Persulfate Digestion Method

Phosphorus, Reactive (Orthophosphate)

Method 8178 Amino Acid Method (0.23 to 30.00 mg/L PO₄³⁻)

Phosphorus, Reactive

Method 8114 Molybdovanadate Rapid Liquid Method Pour-Thru Cell HR (0.3 to 45.0 mg/L PO₄³⁻)

Phosphorus, Reactive (Orthophosphate)

Method 8114 Molybdovanadate Method Reagent Solution or AccuVac® Ampuls (0.3 to 45.0 mg/L PO₄³⁻)

Phosphorus, Reactive

★ Denotes USEPA accepted or approved for water or wastewater analysis.

(Orthophosphate)

Method 8114 Molybdovanadate Method Test 'N Tube™ Vials HR (1.0 to 100.0 mg/L PO₄³⁻)

Phosphorus, Reactive

Method 10055 Ascorbic Acid Rapid Liquid Method Pour-Thru Cell LR (19 to 3000 µg/L PO₄³⁻)

Phosphorus, Reactive (Orthophosphate)

★ Method 8048 PhosVer 3 (Ascorbic Acid) Method Powder Pillows or AccuVac® Ampuls (0.02 to 2.50 mg/L PO₄³⁻)

Phosphorus, Reactive (Orthophosphate)

★ Method 8048 PhosVer® 3 Method Test 'N Tube™ Vials (0.06 to 5.00 mg/L PO₄³⁻ or 0.02 to 1.60 mg/L P)

Phosphorus, Reactive (Orthophosphate) and Total

Method 10209 Reactive; Method 10210 Total Ascorbic Acid Method TNTplus 843 LR (0.15–4.50 mg/L PO₄³⁻ or 0.05–1.50 mg/L PO₄-P)

Phosphorus, Reactive (Orthophosphate) and Total

Method 10209 Reactive; Method 10210 Total Ascorbic Acid Method TNTplus™ 844HR (1.5 to 15.0 mg/L PO₄³⁻ or 0.5 to 5.0 mg/L PO₄-P)

Phosphorus, Reactive (Orthophosphate) and Total

Method 10209 Reactive; Method 10210 Total Ascorbic Acid Method TNTplus™ 845UHR (6 to 60 mg/L PO₄³⁻ or 2 to 20 mg/L PO₄-P)

Phosphorus, Reactive (Orthophosphate)

Method 10214 Molybdovanadate Method TNTplus™ 846 (5.0 to 90.0 mg/L PO₄³⁻ or 1.6 to 30 mg/L PO₄-P)

Phosphorus, Total

★ Method 8190 PhosVer® 3 with Acid Persulfate Digestion Method Test 'N Tube™ Vials (0.06 to 3.50 mg/L PO₄³⁻ or 0.02 to 1.10 mg/L P)

Phosphorus, Total

Method 10127 Molybdovanadate Method with Acid Persulfate Digestion Test 'N Tube™ Vials HR (1.0 to 100.0 mg/L PO₄³⁻)

Potassium

Method 8049 Tetraphenylborate Method Powder Pillows (0.1 to 7.0 mg/L)

Quaternary Ammonium Compounds

Method 8337 Direct Binary Complex Method Powder Pillows (0.2 to 5.0 mg/L as CTAB)

Selenium

Method 8194 Diaminobenzidine Method (0.01 to 1.00 mg/L)

Silica

Method 8282 Heteropoly Blue Method Pour-Thru Cell ULR (3 to 1000 µg/L as SiO₂)

Silica

Method 8282 Heteropoly Blue Rapid Liquid Method Pour-Thru Cell ULR (3 to 1000 µg/L as SiO₂)

Silica

Method 8186 Heteropoly Blue Method Powder Pillows LR (0.010 to 1.600 mg/L as SiO₂)

Silica

Method 8185 Silicomolybdate Method Powder Pillows HR (1 to 100 mg/L)

Silver

Table of Contents

★ Denotes USEPA accepted or approved for water or wastewater analysis.

Method 8120 Colorimetric Method Powder Pillows (0.005 to 0.700 mg/L)

Sulfate

★ Method 8051 SulfaVer 4 Method Powder Pillows or AccuVac® Ampuls (2 to 70 mg/L)

Sulfide

★ Method 8131 Methylene Blue Method (5 to 800 µg/L)

Sulfite

Colorimetric Method (0.10 to 5.00 mg/L)

Surfactants, Anionic (Detergents)

Method 8028 Crystal Violet Method (0.002 to 0.275 mg/L as LAS)

Suspended Solids

Method 8006 Photometric Method (5 to 750 mg/L)

Tannin and Lignin

Method 8193 Tyrosine Method (0.1 to 9.0 mg/L)

Toxicity

Method 10017 ToxTrak™ Method , , (0 to 100% Inhibition)

TPH (Total Petroleum Hydrocarbons)

Method 10050 Immunoassay Method

Trihalomethanes

Method 10132 THM Plus™ Method Water Bath Method (10 to 600 ppb as Chloroform)

Volatile Acids

Method 8196 Esterification Method Powder Pillows (27 to 2800 mg/L)

Zinc

Method 8009 Zincon Method Powder Pillows (0.01 to 3.00 mg/L)

Method Precision Data

Expected Precision for DR 2800 Methods

PARAMETER	Method Number	Stored Program	Method	Concentration Range	95% Confidence Interval		
					Lower Limit	Target Conc.	Upper Limit
Aluminum	8012	10	Aluminon	0.008–0.800 mg/L Al	0.385	0.393	0.402
	8326	9	Eriochrome Cyanine R	0.002–0.250 mg/L Al	0.092	0.096	0.101
	10215	barcode	TNTplus 848 Chromazurol S	0.02–0.50 mg/L Al	0.32	0.35	0.38
Barium	8014	20	Turbidimetric	2–100 mg/L Ba	29	30	31
Benzotriazole	8079	30	UV Photolysis	0.2–16.0 mg/L Benzotriazole	9.7	10	10.3
Boron	10061	45	LR, Azomethine H	0.02–1.50 mg/L B	0.87	0.92	0.97
	8015	40	Carmine	0.2–14.0 mg/L B	7.5	7.6	7.7
Bromine	8016	50	DPD	0.05–4.50 mg/L Br ₂	2.79	2.81	2.83
	8016	55	DPD, AccuVac	0.05–4.50 mg/L Br ₂	2.63	2.77	2.9
Cadmium	8017	60	Dithizone	0.7–80.0 µg/L Cd	39.3	40.0	40.7
	10217	barcode	TNTplus 852 Cadion	0.02–0.30 Cd	0.18	0.20	0.22
Chloramine, Mono	10172	67	HR TNT, Indophenol	0.1–10.0 mg/L Cl ₂	5.6	5.9	6.2
	10171	66	LR TNT, Indophenol	0.04–4.50 mg/L Cl ₂	2.58	2.60	2.62
Chloride	8113	70	Mercuric Thiocyanate	0.1–25.0 mg/L Cl ⁻	15.7	17.8	19.9
Chlorine Dioxide	n/a	78	Amaranth	20–500 µg/L ClO ₂	192	250	308
	10126	76	DPD/Glycine	0.04–5.00 mg/L ClO ₂	2.94	3.11	3.28
	10126	77	DPD/Glycine AccuVac	0.04–5.00 mg/L ClO ₂	2.76	2.83	3.00
	8138	75	HR, Direct Reading (445 nm)	5–1000 mg/L ClO ₂	459	475	492
	8065	72	LR, Chlorophenol Red	0.01–1.00 mg/L ClO ₂	0.50	0.53	0.55
	8345	73	MR, Direct Reading (360 nm)	0.0–50 mg/L ClO ₂	42	43	45
Chlorine, Free	8021	80	DPD	0.02–2.00 mg/L Cl ₂	1.24	1.25	1.26
	8021	85	DPD, AccuVac	0.02–2.00 mg/L Cl ₂	1.17	1.23	1.29
	10059	82	DPD Rapid Liquid	0.02–2.00 mg/L Cl ₂	1.17	1.18	1.19
	10102	89	DPD TNT	0.09–5.00 mg/L Cl ₂	2.63	2.68	2.72
	10069	88	HR, DPD	0.1–10.0 mg/L Cl ₂	5.3	5.4	5.5
Chlorine, Total	8167	80	DPD	0.02–2.00 mg/L Cl ₂	1.24	1.25	1.26
	8167	85	DPD, AccuVac	0.02–2.00 mg/L Cl ₂	1.17	1.29	1.23
	10060	82	DPD, Rapid Liquid	0.02–2.00 mg/L Cl ₂	1.17	1.19	1.18
	10101	89	DPD, TNT	0.09–5.00 mg/L Cl ₂	2.63	2.68	2.72
	10070	88	HR, DPD	0.1–10.0 mg/L Cl ₂	5.3	5.4	5.5
	8370	86	ULR, DPD	2–500 µg/L Cl ₂	247	255	263

Method Precision Data

Expected Precision for DR 2800 Methods (continued)

PARAMETER	Method Number	Stored Program	Method	Concentration Range	95% Confidence Interval		
					Lower Limit	Target Conc.	Upper Limit
Chromium, Hexavalent	8023	90	1,5 Diphenylcarbohydra zide	0.010–0.700 mg/L Cr ⁶⁺	0.497	0.500	0.503
	8023	95	1,5 Diphenylcarbohydra zide, AccuVac	0.010–0.700 mg/L Cr ⁶⁺	0.497	0.503	0.5
	10218	barcode	TNTplus 854 1,5 Diphenylcarbohydra zide	0.03–1.00 mg/L Cr ⁶⁺	0.48	0.50	0.52
Chromium, Total	10219	barcode	TNTplus 854 1,5 Diphenylcarbohydra zide	0.03–1.00 mg/L Cr	0.48	0.50	0.52
	8024	100	Alkaline Hypobromite Oxidation	0.01–0.70 mg/L Cr	0.469	0.50	0.503
Cobalt	8078	110	PAN	0.01–2.00 mg/L Co	0.99	1.00	1.01
Color, True and Apparent	8025	120	Platinum-Cobalt (455 nm)	15–500 units Pt-Co	245	250	255
	8025	125	Platinum-Cobalt (465 nm)	15–500 units Pt-Co	247	250	253
Copper	8506	135	Bicinchoninate	0.04–5.00 mg/L Cu	0.97	1.00	1.03
	8026	140	Bicinchoninate, AccuVac	0.04–5.00 mg/L Cu	0.99	1.00	1.01
	8143	145	Porphyrin	1–210 µg/L Cu	47	50	53
Cyanide	8027	160	Pyridine-Pyrazolone	0.002–0.240 mg/L CN ⁻	0.090	0.100	0.110
Cyanuric Acid	8139	170	Turbidimetric	5–50 mg/L Cyanuric Acid	7	10	13
Fluoride	8029	190	SPADNS	0.02–2.00 mg/L F ⁻	0.97	1.00	1.03
	8029	195	SPADNS, AccuVac	0.02–2.00 mg/L F ⁻	0.92	1.00	1.08
Formaldehyde	8110	200	MBTH	2–500 µg/L CH ₂ O	312	320	328
Hardness, Calcium	8030	220	Calmagite	0.05–4.00 mg/L Ca as CaCO ₃	1.90	2.00	2.10
Hardness, Magnesium	8030	225	Calmagite	0.05–4.00 mg/L, Mg as CaCO ₃	1.92	2.00	2.09
Hardness, Total	8374	227	ULR, Chlorophosphonazo, Rapid Liquid	8–1000 µg/L, Ca and Mg as CaCO ₃	478	500	522
Hardness, Total	8374	228	ULR, Chlorophosphonazo	8–1000 µg/L, Ca and Mg as CaCO ₃	478	500	522
Hydrazine	8141	231	p-Dimethylaminoben zaldehyde	4–600 µg/L N ₂ H ₄	242	250	258
	8141	232	AccuVac, p-Dimethylaminoben zaldehyde	4–600 µg/L N ₂ H ₄	240	250	260

Expected Precision for DR 2800 Methods (continued)

PARAMETER	Method Number	Stored Program	Method	Concentration Range	95% Confidence Interval		
					Lower Limit	Target Conc.	Upper Limit
Iodine	8031	245	DPD	0.07–7.00 mg/L I ₂	4.43	4.46	4.50
	8031	246	DPD, AccuVac	0.07–7.00 mg/L I ₂	4.17	4.39	4.50
Iron	8147	260	FerroZine	0.009–1.400 mg/L Fe	0.985	1.000	1.015
	8147	261	FerroZine, Rapid Liquid	0.009–1.400 mg/L Fe	0.997	1.000	1.003
Iron, Ferrous	8146	255	1,10 Phenanthroline	0.02–3.00 mg/L Fe ²⁺	1.99	2.00	2.01
	8146	257	1,10 Phenanthroline, AccuVac	0.02–3.00 mg/L Fe ²⁺	2.03	2.05	2.07
Iron, Total	8008	265	FerroVer	0.02–3.00 mg/L Fe	1.99	2.00	2.01
	8112	270	TPTZ	0.012–1.800 mg/L Fe	1.032	1.043	1.054
	8365	275	FerroMo	0.01–1.80 mg/L Fe	0.98	1.00	1.02
	8008	267	FerroVer, AccuVac	0.02–3.00 mg/L Fe	2.03	2.05	2.07
	8112	272	TPTZ, AccuVac	0.012–1.800 mg/L Fe	1.008	1.024	1.040
Lead	8317	283	LeadTrak Fast Column Extraction	5–150 µg/L Pb	48	53	58
	8033	280	Dithizone	0–300 µg/L Pb	122	147	172
	10216	barcode	TNTplus 850, PAR	0.1–2.0 mg/L Pb	0.8	1.0	1.2
Manganese	8149	290	PAN	0.006–0.700 mg/L Mn	0.472	0.481	0.490
	8034	295	Periodate Oxidation	0.1–20.0 mg/L Mn	9.9	10.0	10.1
Mercury	10065	312	Cold Vapor	0.1–2.5 µg/L Hg	0.9	1.0	1.1
Molybdenum, Molybdate	8169	315	LR, Ternary Complex	0.02–3.00 mg/L Mo ⁶⁺	1.94	2.00	2.06
	8036	320	HR, Mercaptoacetic Acid	0.2–40.0 mg/L Mo ⁶⁺	9.7	10.0	10.3
	8036	322	HR, AccuVac, Mercaptoacetic Acid	0.2–40.0 mg/L Mo ⁶⁺	9.7	10.0	10.3
Nickel	8150	340	PAN	0.006–1.000 mg/L Ni	0.492	0.500	0.508
	8037	335	Heptoxime	0.02–1.80 mg/L Ni	0.97	1.00	1.03
	10220	barcode	TNTplus 856 Dimethylglyoxime	0.1–6.0 mg/L Ni	4.9	5.0	5.1
Nitrogen, Ammonia	8038	380	Nessler	0.02–2.50 mg/L NH ₃ -N	1.06	1.07	1.08
	8155	385	Salicylate	0.01–0.50 mg/L NH ₃ -N	0.45	0.47	0.49
	10031	343	HR, TNT, Salicylate	0.4–50.0 mg/L NH ₃ -N	32.1	34.0	35.9
	10023	342	LR, TNT, Salicylate	0.02–2.50 mg/L NH ₃ -N	0.83	0.93	1.03
	10205	barcode	TNTplus 832 ,HR Salicylate	1–47 mg/L NH ₃ -N	9	10	11
	10205	barcode	TNTplus 831, LR Salicylate	1–12 mg/L NH ₃ -N	9.6	10.0	10.4
	10205	barcode	TNTplus 830, ULR Salicylate	0.015–2.000 mg/L NH ₃ -N	0.968	1.000	1.032

Method Precision Data

Expected Precision for DR 2800 Methods (continued)

PARAMETER	Method Number	Stored Program	Method	Concentration Range	95% Confidence Interval		
					Lower Limit	Target Conc.	Upper Limit
Nitrogen, Nitrate	8039	355	HR, Cadmium Reduction	0.3–30.0 mg/L NO ₃ ⁻ -N	14	14.7	15.4
	8039	361	HR, AccuVac Cadmium Reduction	0.3–30.0 mg/L NO ₃ ⁻ -N	14	14.7	15.4
	10020	344	HR, TNT, Chromotropic Acid	0.2–30.0 mg/L NO ₃ ⁻ -N	9.5	10.0	10.5
	8192	351	LR, Cadmium Reduction	0.01–0.50 mg/L NO ₃ ⁻ -N	0.31	0.36	0.41
	8171	353	MR, Cadmium Reduction	0.1–10.0 mg/L NO ₃ ⁻ -N	4.3	4.5	4.8
	8171	359	MR, AccuVac Cadmium Reduction	0.1–10.0 mg/L NO ₃ ⁻ -N	6	6.4	6.8
	10206	barcode	TNTplus 836, HR Dimethylphenol	5–35 mg/L NO ₃ -N	9	10	11
	10206	barcode	TNTplus 835, LR Dimethylphenol	0.23–13.5 mg/L NO ₃ -N	9.37	10.00	10.63
Nitrogen, Nitrite	8153	373	HR, Ferrous Sulfate	2–250 mg/L NO ₂ ⁻	191	200	209
	8507	371	LR, Diazotization	0.002–0.300 mg/L NO ₂ ⁻ -N	0.294	0.300	0.306
	8507	375	LR, AccuVac Diazotization	0.002–0.300 mg/L NO ₂ ⁻ -N	0.147	0.150	0.153
	10019	345	LR, TNT Diazotization	0.002–0.300 mg/L NO ₂ ⁻ -N	0.297	0.300	0.303
	10207	barcode	TNTplus 839 Diazotization	0.015–0.600 mg/L NO ₂ -N	0.290	0.300	0.310
Nitrogen, Total Inorganic	10021	346	TNT, Titanium Trichloride Reduction	0.2–25.0 mg/L N	21.2	21.4	21.6
Nitrogen, Total Kjeldahl	8075	399	Nessler	1–150 mg/L TKN	70	76	82
Nitrogen, Total	10072	394	HR, TNT Persulfate Digestion	10–150 mg/L N	98	100	102
	10071	350	LR, TNT Persulfate Digestion	0.5–25.0 mg/L N	9.6	10.0	10.4
	10208	barcode	TNTplus 827, HR Persulfate Digestion	5–40 mg/L N	29	30	31
	10208	barcode	TNTplus 826, LR Persulfate Digestion	1–16 mg/L N	9.7	10.0	10.3
	10208	barcode	TNTplus 828, UHR Persulfate Digestion	20–100 mg/L N	48	50	52

Expected Precision for DR 2800 Methods (continued)

PARAMETER	Method Number	Stored Program	Method	Concentration Range	95% Confidence Interval		
					Lower Limit	Target Conc.	Upper Limit
Oxygen Demand, Chemical (COD)	8000	435	HR, Reactor Digestion	200–15,000 mg/L COD	793	800	807
	8000	430	LR, Reactor Digestion	3–150 mg/L COD	77	80	83
	10067	432	Manganese III	20–1000 mg/L COD	575	600	625
	8000	431	ULR, Reactor Digestion	0.7–40.0 mg/L COD	28.9	30.0	31.2
	8000	barcode	TNTplus 822, HR Reactor Digestion	20–1500 mg/L COD	736	750	764
	8000	barcode	TNTplus 821, LR Reactor Digestion	3–150 mg/L COD	72	75	78
	10212	barcode	TNTplus 823, UHR Reactor Digestion	250–15,000 mg/L COD	5805	6000	6195
	10211	barcode	TNTplus 820, ULR Reactor Digestion	1–60 mg/L COD	48	50	52
Oxygen, Dissolved	8166	445	HR, AccuVac, HRDO	0.3–15.0 mg/L O ₂	6.7	7.0	7.3
	8316	446	LR, AccuVac, Indigo Carmine	6–800 µg/L O ₂	N/L	N/L	N/L
	8333	448	UHR, AccuVac	1.0–40.0 mg/L O ₂	23.6	26.4	29.2
Oxygen Scavengers	8140	184	Iron Reduction	15–1000 µg/L, MEKO (Methylethylketoxime)	976	983	990
	8140	183	Iron Reduction	13–1500 µg/L Isoascorbic acid	886	893	899
	8140	182	Iron Reduction	9–1000 µg/L Hydroquinone	600	605	609
	8140	181	Iron Reduction	3–450 µg/L DEHA (Diethylhydroxylamine)	223	226	229
	8140	180	Iron Reduction	5–600 µg/L Carbohydrazide	299	302	304
Ozone	8311	456	HR, AccuVac, Indigo	0.01–1.50 mg/L O ₃	1.05	1.23	1.41
	8311	454	LR, AccuVac, Indigo	0.01–0.25 mg/L O ₃	0.14	0.20	0.26
	8311	455	MR, AccuVac, Indigo	0.01–0.75 mg/L O ₃	0.42	0.59	0.76
Phenols	8047	470	4-Aminoantipyrine	0.002–0.200 mg/L phenol	0.093	0.100	0.107
Phosphonates	8007	501	Persulfate UV Digestion	multiple ranges	N/L	N/L	N/L
Phosphorus, Acid Hydrolyzable	8180	536	TNT, PhosVer 3 with Acid Hydrolysis	0.06–3.50 mg/L PO ₄ ³⁻	2.92	2.98	3.04

Method Precision Data

Expected Precision for DR 2800 Methods (continued)

PARAMETER	Method Number	Stored Program	Method	Concentration Range	95% Confidence Interval		
					Lower Limit	Target Conc.	Upper Limit
Phosphorus, Reactive	8114	480	Molybdovanadate	0.3–45.0 mg/L PO ₄ ³⁻	30.42	30.80	31.18
	8178	485	Amino Acid	0.23–30.00 mg/L PO ₄ ³⁻	10.60	10.70	10.80
	10055	488	LR, Ascorbic Acid Rapid Liquid	19–3000 µg/L PO ₄ ³⁻	575	600	625
	8048	490	PhosVer 3	0.02–2.50 mg/L PO ₄ ³⁻	1.98	2.00	2.02
	8114	482	AccuVac, Molybdovanadate	0.3–45.0 mg/L PO ₄ ³⁻	31.0	31.2	31.4
	8048	492	AccuVac, PhosVer 3	0.02–2.50 mg/L PO ₄ ³⁻	1.99	2.00	2.01
	8114	489	HR, Molybdovanadate, Rapid Liquid	0.3–45.0 mg/L PO ₄ ³⁻	10.4	10.5	10.7
	8048	535	TNT, PhosVer 3	0.06–5.00 mg/L PO ₄ ³⁻	2.92	2.98	3.04
	8114	540	TNT, Molybdovanadate	1.0–100.0 mg/L PO ₄ ³⁻	49.4	50.3	51.2
	10214	barcode	TNTplus 846, Molybdovanadate	5.0–90.0 mg/L PO ₄ ³⁻	48.4	50.0	51.6
Phosphate, Total and Reactive	10209 10210	barcode	TNTplus 845, Ascorbic Acid	6–60 mg/L PO ₄ ³⁻	49	50.0	51
	10209 10210	barcode	TNTplus 844, Ascorbic Acid	1.5–15.0 mg/L PO ₄ ³⁻	9.5	10.0	10.5
	10209 10210	barcode	TNTplus 843, Ascorbic Acid	0.15–1.50 mg/L PO ₄ ³⁻	3.39	3.50	3.61
Phosphorus, Total & Acid Hydrolyzable	8190	536	TNT, PhosVer 3 with Acid Persulfate	0.06–3.50 mg/L PO ₄ ³⁻	3.05	3.12	3.19
Phosphorus, Total HR	10127	540	TNT, Molybdovanadate with Acid Persulfate	1.0–100.0 mg/L PO ₄ ³⁻	52.1	52.8	53.5
Potassium	8049	905	Tetraphenylborate	0.1–7.0 mg/L K	4.8	5.0	5.2
Quaternary Ammonium Compounds	8337	401	Direct Binary Complex	0.2–5.0 mg/L CTAB	2.74	3.00	3.26
Selenium	8194	640	Diaminobenzidine	0.01–1.00 mg/L Se	0.47	0.50	0.53
Silica	8185	656	HR, Silicomolybdate	1–100 mg/L SiO ₂	47	49	51
	8186	651	LR, Heteropoly Blue	0.010–1.600 mg/L SiO ₂	0.970	0.980	0.990
	8282	645	ULR, Heteropoly Blue	3–1000 µg/L SiO ₂	526	530	534
	8282	645	ULR, Heteropoly Blue Rapid Liquid	3–1000 µg/L SiO ₂	526	530	534
Silver	8120	660	Colorimetric	0.005–0.700 mg/L Ag	0.468	0.480	0.492
Sulfate	8051	680	SulfaVer 4	2–70 mg/L SO ₄ ²⁻	30	40	50
	8051	685	AccuVac, SulfaVer 4	2–70 mg/L SO ₄ ²⁻	32	40	48
Sulfide	8131	690	Methylene Blue	5–800 µg/L S ²⁻	504	520	536
Sulfite	—	692	HPT430	0.10–5.00	N/L	N/L	N/L
Surfactants, Anionic (Detergents)	8028	710	Crystal Violet	0.002–0.275 mg/L LAS	0.172	0.180	0.188

Expected Precision for DR 2800 Methods (continued)

PARAMETER	Method Number	Stored Program	Method	Concentration Range	95% Confidence Interval		
					Lower Limit	Target Conc.	Upper Limit
Suspended Solids	8006	630	Photometric	5–750 mg/L Susp. Solids	N/L	N/L	N/L
Tannin & Lignin	8193	720	Tyrosine	0.1–9.0 mg/L tannin	5.8	6.0	6.2
TOC HR (Total Organic Carbon)	10128	426	Colorimetric	100–700 mg/L C	341	354	367
TOC LR (Total Organic Carbon)	10129	427	Colorimetric	0.3–20.0 mg/L C	7.8	8.7	9.5
TOC MR (Total Organic Carbon)	10173	425	Colorimetric	15–150 mg/L C	68	71	73
Tolyltriazole	8079	730	UV Photolysis	1.0–20.0 mg/L Tolyltriazole	11.6	12.0	12.4
Trihalomethanes	10132	725	THM Plus™	10–600 µg/L THM	53	66	73
Volatile Acids	8196	770	Esterification	27–2800 mg/L HOAC	1211	1343	1475
Zinc	8009	780	Zincon	0.01–3.00 mg/L Zn	0.97	1.0	1.03

Working with Chemical Procedures

This document explains the layout and location of information in a typical written chemical procedure. Layout may vary slightly between procedures, depending on the level of detail and the steps required for a particular test.

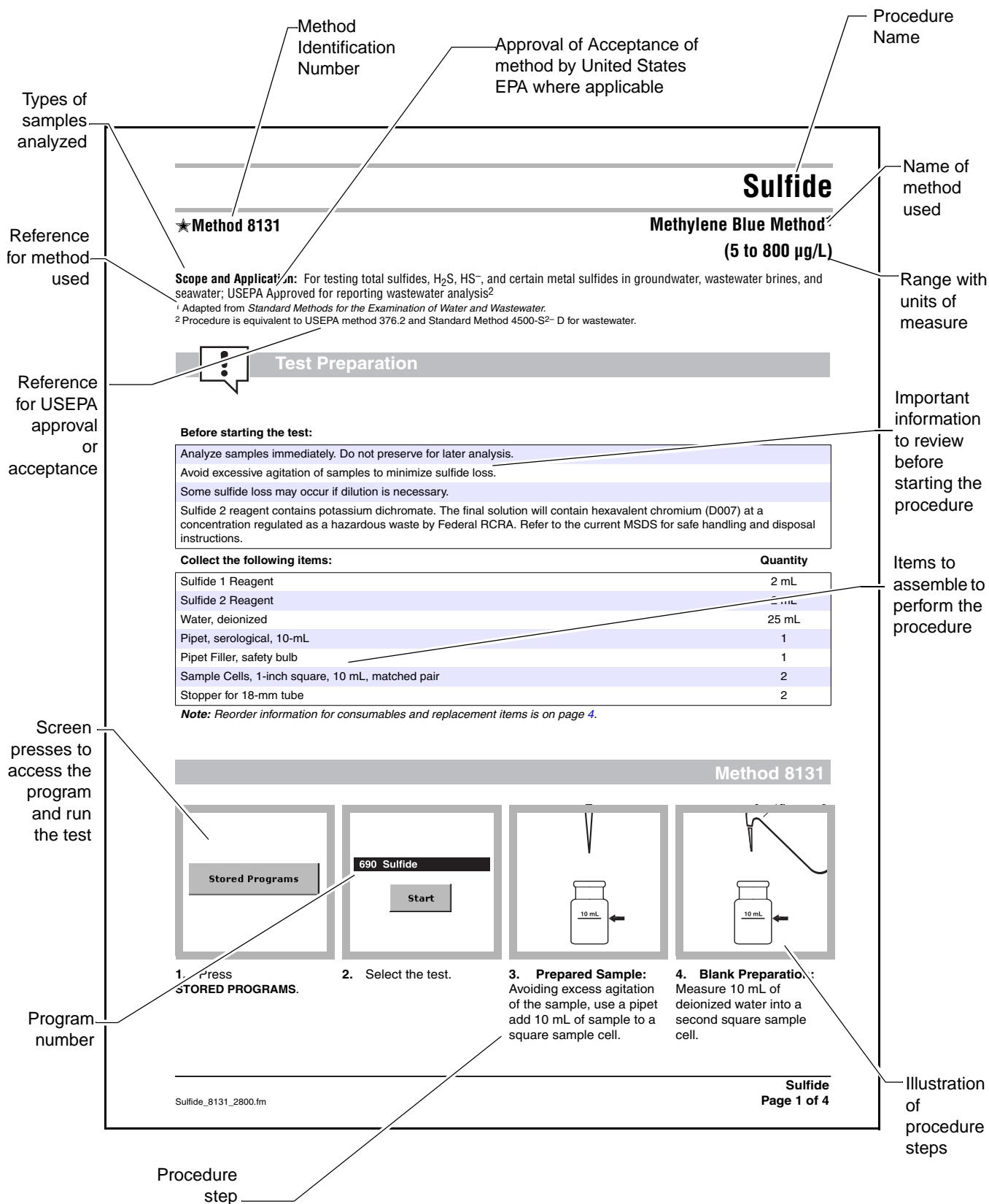

Levels of common sample substances or conditions that will cause inaccurate results

Sulfide (5 to 800 µg/L)

Interferences

Table 1 Interfering Substances and Levels

Interfering Substance	Interference Levels and Treatments
Strong reducing substances (sulfite, thiosulfate and hydrosulfite)	Interferes by reducing the blue color or preventing its development.
Sulfide, high levels	High concentrations of sulfide may inhibit full color development and require sample dilution. Some sulfide loss may occur when the sample is diluted.
Turbidity	For turbid samples, prepare a sulfide-free blank as follows. Use it in place of the deionized water blank in the procedure. <ol style="list-style-type: none"> 1. Measure 25 mL of sample into a 50-mL Erlenmeyer flask. 2. Add Bromine Water dropwise with constant swirling until a permanent yellow color just appears. 3. Add Phenol Solution dropwise until the yellow color just disappears. Use this solution to replace the deionized water in step 4 of the procedure.

Specific sampling and storage information for this test

Sample Collection, Storage, and Preservation

Collect samples in clean plastic or glass bottles. Fill completely and cap tightly. Avoid excessive agitation or prolonged exposure to air. Analyze samples immediately.

Summary of Method

Concise explanation of method

Hydrogen sulfide and acid-soluble metal sulfides react with N,N-dimethyl-p-phenylenediamine sulfate to form methylene blue. The intensity of the blue color is proportional to the sulfide concentration. High sulfide levels in oil field waters may be determined after proper dilution. Test results are measured at 665 nm.

Sulfide (5 to 800 µg/L)

Consumables and Replacement Items

Required Reagents

Description	Quantity/Test	Unit	Cat. No.
Sulfide Reagent Set (100 tests), includes:	—	—	22445-00
(2) Sulfide 1 Reagent	2 mL	100 mL MDB	1816-32
(2) Sulfide 2 Reagent	2 mL	100 mL MDB	1817-32
Water, deionized	25 mL	4 liters	272-56

Required Apparatus

Description	Quantity/Test	Unit	Cat. No.
Pipet, serological, 10-mL	1	each	532-38
Pipet Filler, safety bulb	1	each	14651-00
Sample Cells, 1-inch square, 10 mL, matched pair	2	2/pkg	24954-02
Stopper, for 18-mm Tube	2	6/pkg	1731-06

Optional Reagents and Apparatus

Description	Unit	Cat. No.
Bromine Water	29 mL	2211-20
Phenol Solution	29 mL	2112-20
Stopper, for 18-mm Tube	25/pkg	1731-25

Lists all reagents and standards required for the procedure

Quantity of reagent or apparatus needed to perform the procedure

Items recommended for accuracy verification



FOR TECHNICAL ASSISTANCE, PRICE INFORMATION AND ORDERING:
 In the U.S.A. – Call toll-free 800-227-4224
 Outside the U.S.A. – Contact the HACH office or distributor serving you.
 On the Worldwide Web – www.hach.com, E-mail – techhelp@hach.com

HACH COMPANY
 WORLD HEADQUARTERS
 Telephone: (970) 669-3050
 FAX: (970) 669-2932

© Hach Company, 2005. All rights reserved. Printed in Germany.

Updated June 05 Edition 1

Method 10202

Immunoassay Method¹

Scope and Application: For water

¹ This test is semi-quantitative. Results are expressed as greater or less than the threshold value used.



Test Preparation

This method analyzes for Alachlor in water. Sample calibrators and reagents are added to cuvettes coated with Alachlor-specific antibodies. The color that develops is then measured and compared with the color measurements of the calibrators. The test requires about 30 minutes for complete analysis. As many as 20 cuvettes (18 samples and 2 calibrators) can be run simultaneously.

Before starting the test:

Read the entire procedure before starting. Identify and make ready all the necessary reagents, cuvettes, and other apparatus before beginning the analysis.

Timing is critical; follow instructions carefully.

A consistent technique when mixing the cuvettes is critical to this test. The best results come from using the cuvette rack and mixing as described in [Using the 1-cm MicroCuvette Rack on page 4](#). Cuvettes can be mixed individually, but test results may not be as consistent.

Handle the cuvettes carefully. Scratches on the inside or outside may cause erroneous results. Carefully clean the outside of the cuvettes with a clean absorbent cloth or tissue before placing them into the instrument.

Antibody cuvettes and enzyme conjugate are made in matched lots. Do not mix reagent lots.

To avoid damaging the Color Developing Solution, do not expose it to direct sunlight.

The cuvette rack is designed to be inverted with the cuvettes in place. This is especially helpful when running many samples at once; the cuvettes can remain in the rack and be processed together until they are read in the spectrophotometer.

Twenty Antibody Cuvettes are provided with each reagent set. One Antibody Cuvette will be used for each calibrator and each sample. Cuvettes are not reusable.

Protective nitrile gloves are recommended for this procedure.

Collect the following items

Quantity

Alachlor Reagent Set	1
Caps, flip spout	1
Marker, laboratory	1
Rack, for 1-cm Micro Cuvettes	1
Wipes, disposable	1
Pipet, TenSette®, 0.1–1.0 mL	1
Pipet tip for 19700-01, TenSette Pipet	1

Reorder information for consumables and replacement items is on page [7](#).

Immunoassay for Water

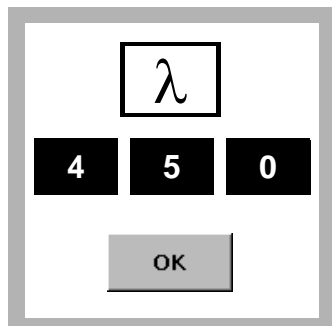

1. Press **SINGLE WAVELENGTH**

Press **OPTIONS** and the λ button. Enter

450 nm and press **OK**.

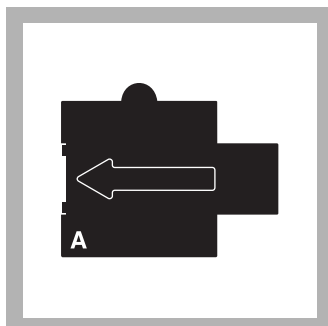

2. Insert Adapter A.

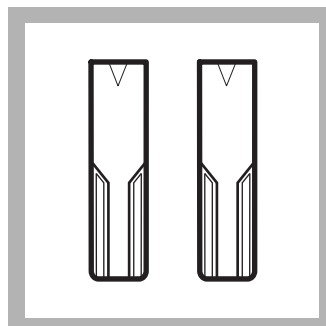

3. Label an Antibody Cuvette for each calibrator and each sample to be tested.

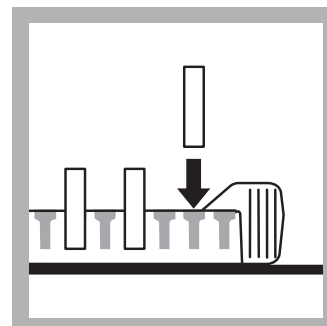

4. Insert the cuvettes into the rack snugly.

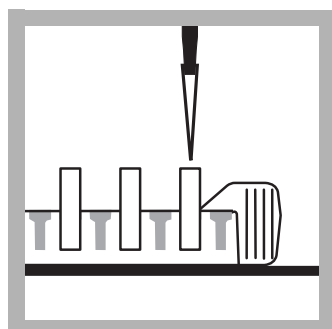

5. Pipet 0.5 mL of each calibrator into the appropriately labeled cuvette.

Use a new pipette tip for each calibrator.

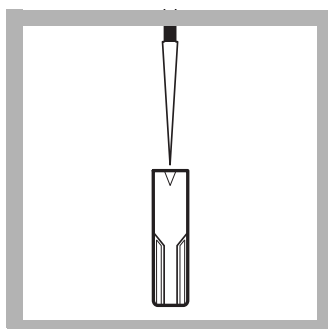

6. Pipet 0.5 mL of each sample to be tested into the appropriately labeled cuvette.

Use a new pipette tip for each sample.

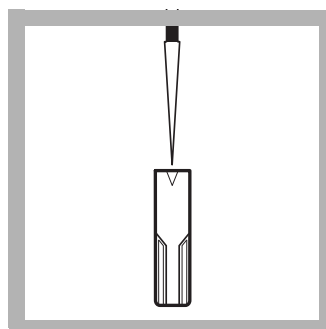

7. Immediately pipet 0.5 mL of Alachlor Enzyme Conjugate into each cuvette.

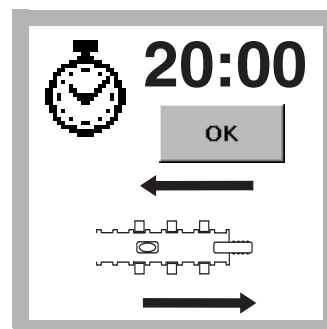

8. Press **OPTIONS**. Press **TIMER**. Enter 20:00 minutes and press **OK**.

A 20-minute reaction time will begin.

Immediately mix the contents of the cuvettes for 30 seconds using the technique described in [Using the 1-cm MicroCuvette Rack on page 4](#).

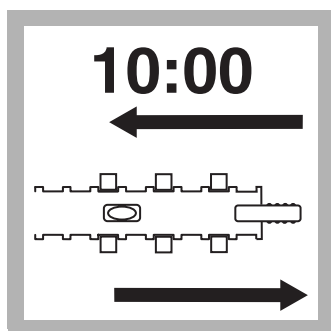

9. After 10 minutes mix the contents of the rack for 30 seconds using the technique described in [Using the 1-cm MicroCuvette Rack on page 4](#).

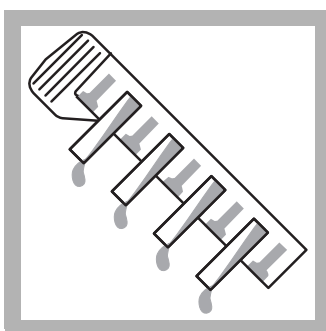

10. At the end of the 20-minute period, discard the contents of all the cuvettes into an appropriate waste container.

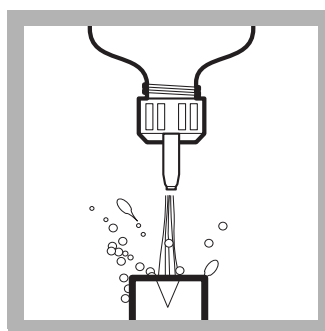

11. Wash each cuvette forcefully and thoroughly four times with deionized water. Empty the rinse water into the waste container.

Ensure that most of the water is drained from the cuvettes by turning the cuvettes upside down and tapping them lightly on a paper towel.

Color Development

Important Note: Timing is critical. Follow instructions carefully.

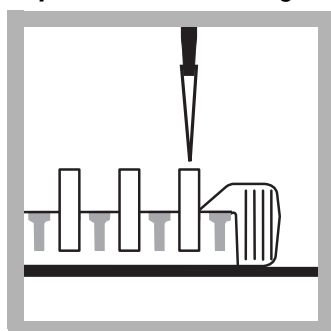

12. With the cuvettes still held snugly in the rack, pipet 0.5 mL of Color Developing Solution into each Antibody Cuvette.

Use a new pipette tip for each cuvette.

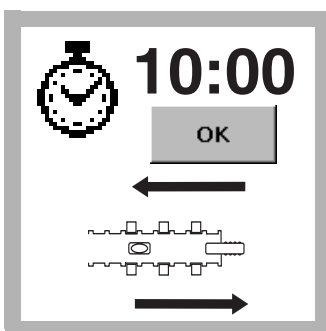

13. Press **OPTIONS**. Press **TIMER**. Enter 10:00 minutes and press **OK**.

A reaction period will begin. Mix, using the instructions on page 4.

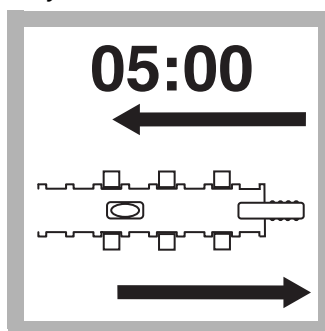

14. After 5 minutes, mix the contents of the rack a second time for a period of 30 seconds using the same technique as step 13.

Solutions will turn blue in some or all of the cuvettes.

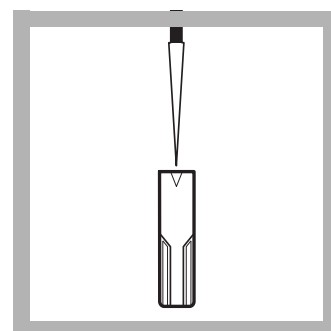

15. At the end of the 10-minute reaction period, pipette 0.5 mL of Stop Solution into each cuvette in the same order as the Color Developing Solution was added in step 12.

Slide the rack for 20 seconds ([Using the 1-cm MicroCuvette Rack on page 4](#).)

Blue solutions will turn yellow with the addition of the Stop Solution.

Use the same pipette tip repeatedly for this step.

Measuring the Color

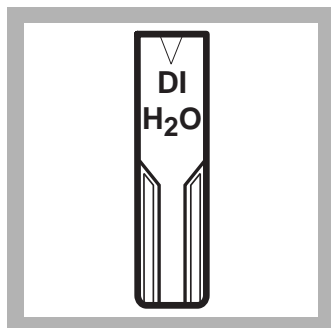

16. Label and fill a Zeroing Cuvette with deionized water. Wipe the outside of all the cuvettes with a tissue to remove water, smudges, and fingerprints.

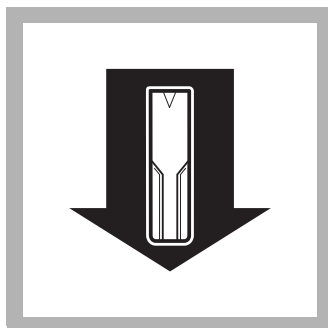

17. Insert the filled Zeroing Cuvette into the cell holder—arrow pointing to the right.

Orient the arrow in the same direction for all cuvettes.

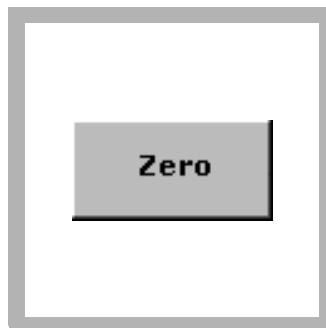

18. Press **ZERO**.
The display will show:
0.000 Abs

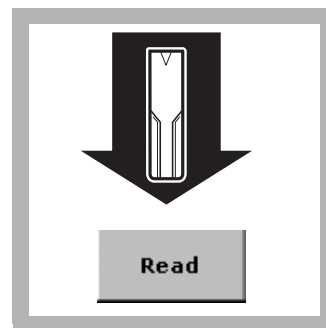

19. Insert the first calibrator into the cell holder.

Press **READ**. The display will give an absorbance reading. Record the results for each calibrator and sample.

Repeat this step for all remaining calibrators and samples.

See [Interpreting and Reporting Results](#) for help with interpretation of results.

Using the 1-cm MicroCuvette Rack

The MicroCuvette rack ([Figure 1](#)) has been designed specifically to aid in achieving precise and accurate results when using the immunoassay technique to analyze several samples at the same time.

Figure 1 The 1-cm MicroCuvette Rack

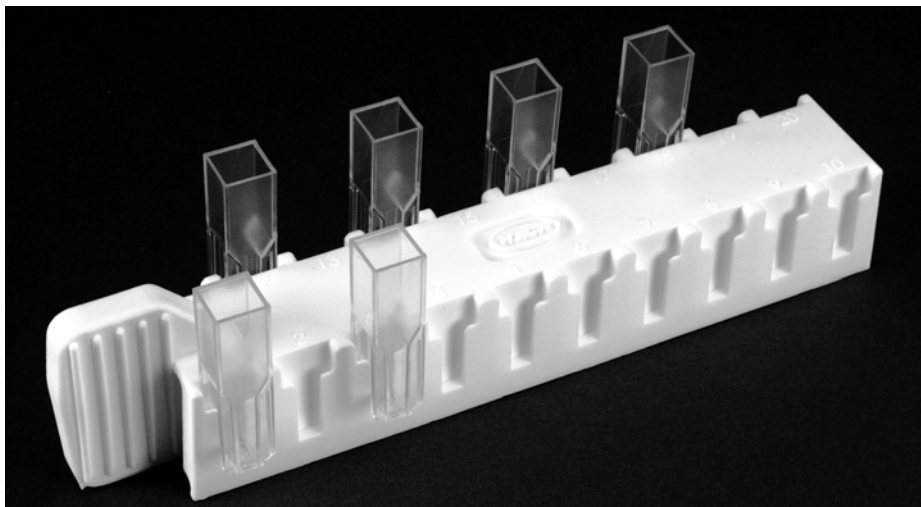

Loading the Rack—The cuvette rack is designed so that it may be inverted with the cuvettes in place. Identify each cuvette with a sample or calibrator number and insert all the cuvettes in the rack before beginning the procedure. Fit the cuvettes snugly into the rack, but do not force them or they may be difficult to remove and their contents may spill. The cuvettes should remain in place when the rack is inverted and tapped lightly.

Mixing—Set the rack on a hard, flat surface that is at least twice the length of the rack. Hold the rack by one end and vigorously slide it back and forth along its long axis for 30 seconds. The rack should move through a distance equal to its own length in each direction.

Interpreting and Reporting Results

There is an inverse relationship between the concentration of Alachlor and the reading. In other words, the higher the reading, the lower the concentration of Alachlor (Table 1).

Table 1 Relative Alachlor Concentration

If the sample reading is...	the sample Alachlor Concentration is...
...less than calibrator reading	...greater than the calibrator concentration
...greater than calibrator reading	...less than the calibrator concentration

Example

Readings:

0.1 ppb Alachlor Calibrator: **0.475 Abs**

0.5 ppb Alachlor Calibrator: **0.245 Abs**

Sample #1: **0.140 Abs**

Sample #2: **0.300 Abs**

Sample #3: **0.550 Abs**

Interpretation

Sample #1—Sample reading is less than the readings for both calibrators. Therefore the sample concentration of Alachlor is greater than both 0.1 ppb and 0.5 ppb Alachlor.

Sample #2—Sample reading is between the readings for the 0.1 ppb and 0.5 ppb Alachlor calibrators. Therefore the sample concentration of Alachlor is between 0.1 ppb and 0.5 ppb.

Sample #3—Sample reading is greater than the readings for both calibrators. Therefore the sample concentration of Alachlor is less than both 0.5 ppb and 0.1 ppb.

Storing and Handling Reagents

- Wear protective gloves and eyewear.
- When storing reagent sets for extended periods of time, keep them out of direct sunlight. Store reagents at a temperature of 4 °C when not in use.
- Keep the foil pouch containing the Antibody Cuvettes sealed when not in use.
- If Stop Solution comes in contact with eyes, wash thoroughly for 15 minutes with cold water and seek immediate medical help.

Sensitivity

The Alachlor immunoassay test cannot differentiate between certain herbicides and metabolites, but it detects their presence to differing degrees. [Table 2](#) shows the required concentration for selected chemicals.

Table 2 Required Concentration for Selected Chemicals

Compound	Concentration to give a positive response of 0.1 ppb Alachlor	Concentration to give a positive response of 0.5 ppb Alachlor
Acetochlor	0.45 ppb	4 ppb
Butachlor	0.09 ppm	1 ppm
2 Chloro-2',6'-Diethylacetaniline	0.030 ppm	2 ppm
Metolachlor	0.085 ppm	2 ppm
2,6-Diethylaniline	0.3 ppm	9 ppm
Propachlor	0.72 ppb	12 ppb

Table 3 Compounds not detectable at 10,000 ppb

Atrazine	2, 4-D
Aldicarb	Chlorpyrifos
Diazoton	Carbendazim
Carbofuran	

Sample Collection and Storage

Collect samples in a clean glass bottle. Do not pre-rinse the bottle with the sample. If the sample cannot be analyzed immediately, store the sample at 4 °C. Samples may be kept for as long as 14 days. Warm the samples to room temperature before analysis.

Diluting Water Samples

Other levels of Alachlor can be tested by diluting the sample and comparing the results to the 0.1 ppb Calibrator. Select the appropriate sample volume from [Table 4](#), place it in a graduated mixing cylinder, and dilute it to 50 mL with deionized water.

Table 4 Sample Volume and Concentration

mL Sample	Representative Concentration using 0.1 ppb Calibrator
0.5	10 ppb
1.0	5 ppb
2.5	2 ppb
5.0	1 ppb

Example:

Dilute 2.5 mL of sample to 50 mL with deionized water. Run the diluted sample in the procedure along with the 0.1 ppb calibrator. If the absorbance of the diluted sample is less than the 0.1 ppb calibrator, the concentration of the original sample is greater than 2 ppb.

Summary of Method

Immunoassay tests use antigen/antibody reactions to test for specific organic compounds in water and soil. Alachlor-specific antibodies, attached to the walls of plastic cuvettes, selectively bind and remove Alachlor from complex sample matrices. A prepared sample and a reagent containing enzyme-conjugate molecules (analyte molecules attached to molecules of an enzyme) are added to the Antibody Cuvettes. During incubation, enzyme-conjugate molecules and Alachlor compete for binding sites on the antibodies. Samples with higher levels of analyte will have more antibody sites occupied by Alachlor and fewer antibody sites occupied by the enzyme-conjugate molecules.

After incubation, the sample and unbound enzyme conjugate are washed from the cuvette and a color-development reagent is added. The enzyme in the conjugate catalyzes the development of color. Therefore, there is an inverse relationship between color intensity and the amount of Alachlor in the sample. The resulting color is then compared with a calibrator to determine whether the Alachlor concentration in the sample is greater or less than the threshold levels. Test results are measured at 450 nm.

Consumables and Replacement Items

Required Reagents

Description	Unit	Cat. No.
Alachlor Reagent Set ¹	20 cuvettes	28130-00

¹ Immunoassay components are manufactured by Beacon Analytical Systems, Inc.

Required Apparatus

Description	Unit	Cat. No.
Adapter, 1-cm square cell	each	
Caps, flip spout	2/pkg	25818-02
Marker, laboratory	each	20920-00
Pipet, TenSette®, Pipet, 0.1–1.0 mL	each	19700-01
Pipet Tips, for TenSette Pipet 19700-01	1000/pkg	21856-28
Rack, for 1-cm Micro Cuvettes	each	48799-00
Wipes, disposable	box	20970-00

Optional Reagents and Apparatus

Description	Unit	Cat. No.
Glasses, Safety	each	27568-00
Gloves, Disposable, Nitrile, Medium ¹	each	25505-02
Pipet Tips, for TenSette Pipet 19700-01	50/pkg	21856-96

¹ Other sizes available.



FOR TECHNICAL ASSISTANCE, PRICE INFORMATION AND ORDERING:

In the U.S.A. – Call toll-free 800-227-4224
Outside the U.S.A. – Contact the HACH office or distributor serving you.
On the Worldwide Web – www.hach.com; E-mail – techhelp@hach.com

HACH COMPANY
WORLD HEADQUARTERS
Telephone: (970) 669-3050
FAX: (970) 669-2932

Aluminum

Method 8012 Powder Pillows

Aluminon Method¹
(0.008 to 0.800 mg/L)

Scope and Application: For water and wastewater

¹ Adapted from *Standard Methods for the Examination of Water and Wastewater*.



Test Preparation

Before starting the test:

Digestion is required for determining total aluminum.

Clean all glassware with 6.0 N HCl and deionized water before use to remove contaminants from the glass.

Check the sample temperature. It must be between 20–25 °C (68 –77 °F) for accurate results.

Collect the following items:

Quantity

AluVer [®] 3 Aluminum Reagent Powder Pillow	1
Ascorbic Acid Powder Pillow	1
Bleaching 3 Reagent Powder Pillow	1
50-mL graduated mixing cylinder with glass stopper	1
Sample cells, 1-inch square, 10 mL	2

Note: Reorder information for consumables and replacement items is on page 6.

Powder Pillows

Method 8012

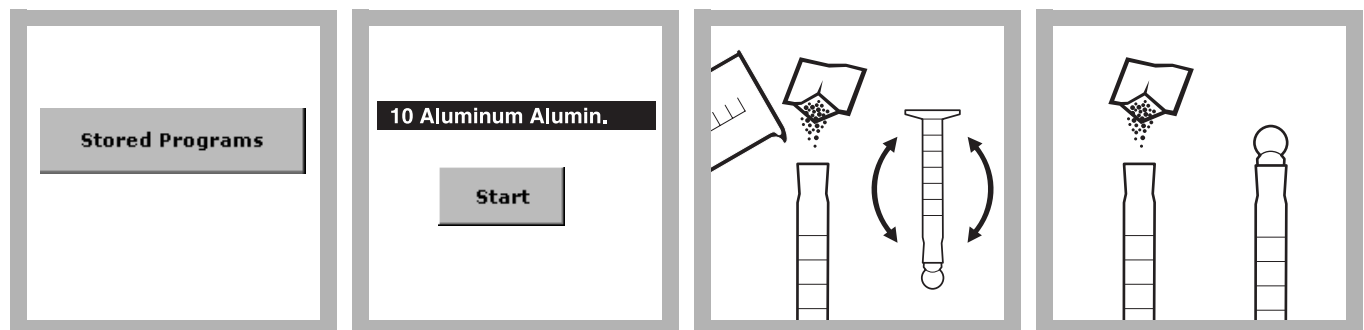

1. Press **STORED PROGRAMS**.

2. Select the test.

3. Fill the cylinder to the 50-mL mark with sample. Add one Ascorbic Acid Powder Pillow.

Stopper. Invert several times to dissolve the powder.

4. Add one AluVer 3 Aluminum Reagent Powder Pillow. Insert the stopper.

An orange to orange-red color will develop if aluminum is present.

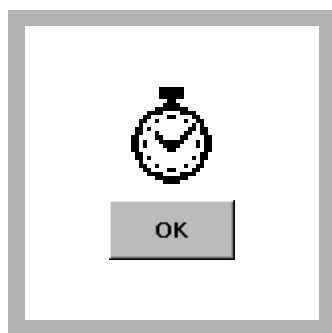

5. Press **TIMER>OK**.

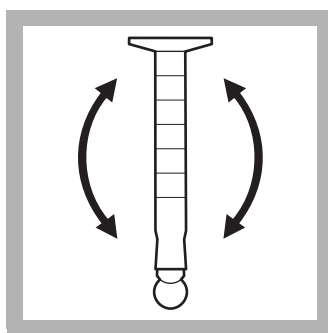

6. Invert repeatedly for one minute to dissolve the powder. Undissolved powder will cause inconsistent results.

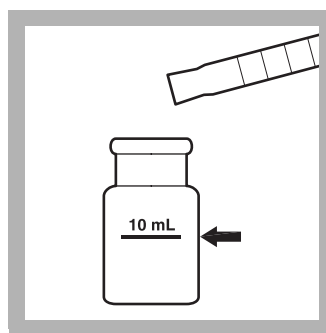

7. **Blank Preparation:** Pour 10 mL of the mixture into a square sample cell.

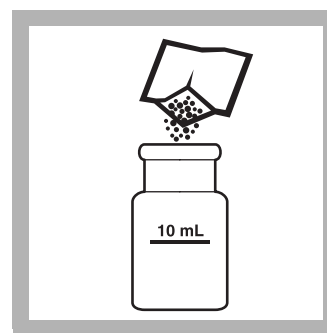

8. Add one Bleaching 3 Reagent Powder Pillow to the blank.



9. Press **TIMER>OK**.

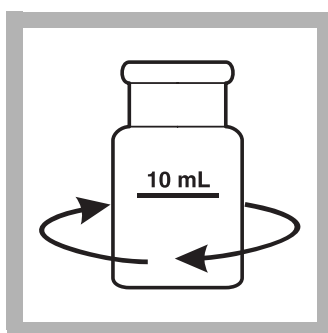

10. Vigorously swirl the cell for 30 seconds. The solution should turn a light to medium orange.

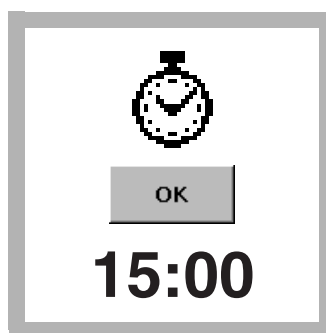

11. Press **TIMER>OK**. A 15-minute reaction period will begin.

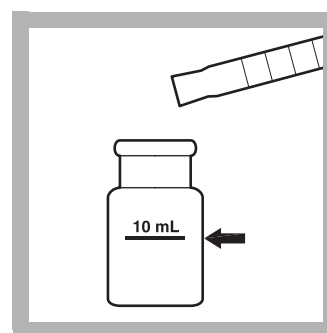

12. **Prepared Sample:** Pour 10 mL of solution from the cylinder into a second square sample cell.



13. Within five minutes after the timer expires, wipe and dry the blank and place it into the cell holder with the fill line facing right.

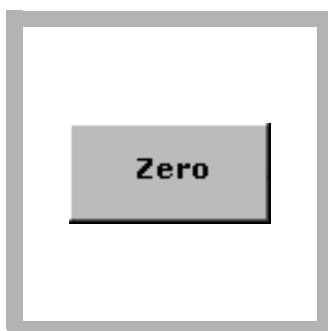

14. Press **ZERO**. The display will show: 0.000 mg/L Al³⁺



15. Immediately wipe and dry the prepared sample and place it into the cell holder with the fill line facing right.

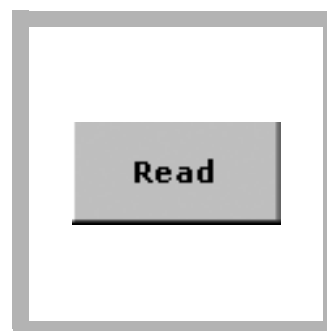

16. Press **READ**. Results are in mg/L Al³⁺.

Interferences

Interfering Substance	Interference Levels and Treatments
Acidity	Greater than 300 mg/L as CaCO ₃ . Samples with greater than 300 mg/L acidity as CaCO ₃ must be treated as follows: <ol style="list-style-type: none"> 1. Add one drop of m-Nitrophenol Indicator Solution¹ to the sample taken in step 3. 2. Add one drop of 5.0 N Sodium Hydroxide Standard Solution¹. Stopper the cylinder. Invert to mix. Repeat as often as necessary until the color changes from colorless to yellow. 3. Add one drop of 5.25 N Sulfuric Acid Standard Solution¹ to change the solution from yellow back to colorless. Continue with the test.
Alkalinity	1000 mg/L as CaCO ₃ . Interferences from higher alkalinity concentrations can be eliminated by the following pretreatment: <ol style="list-style-type: none"> 1. Add one drop of m-Nitrophenol Indicator Solution¹ to the sample taken in step 3. A yellow color indicates excessive alkalinity. 2. Add one drop of 5.25 N Sulfuric Acid Standard Solution¹. Stopper the cylinder. Invert to mix. If the yellow color persists, repeat until the sample becomes colorless. Continue with the test.
Fluoride	Interferes at all levels. See Figure 1 on page 4 .
Iron	Greater than 20 mg/L
Phosphate	Greater than 50 mg/L
Polyphosphate	Polyphosphate interferes at all levels by causing negative errors and must not be present. Before running the test, polyphosphate must be converted to orthophosphate by acid hydrolysis as described under the phosphorus procedures.

¹ See [Optional Reagents on page 6](#) for reorder information.

Fluoride interferes at all levels by complexing with aluminum. The actual aluminum concentration can be determined using the Fluoride Interference Graph ([Figure 1](#)) when the fluoride concentration is known.

To use the fluoride interference graph:

1. Select the vertical grid line along the top of the graph that represents the aluminum reading obtained in step 15.
- Locate the point on the line where it intersects with the horizontal grid line that indicates how much fluoride is present in the sample.
 - Extrapolate the true aluminum concentration by following the curved lines on either side of the intersect point down to the true aluminum concentration.

For example, if the aluminum test result was 0.7 mg/L Al and the fluoride present in the sample was 1 mg/L F⁻, the point where the 0.7 grid line intersects with the 1 mg/L F⁻ grid line falls between the 1.2 and 1.3 mg/L Al curves. In this case, the true aluminum content would be 1.27 mg/L.

Figure 1 Fluoride Interference Graph

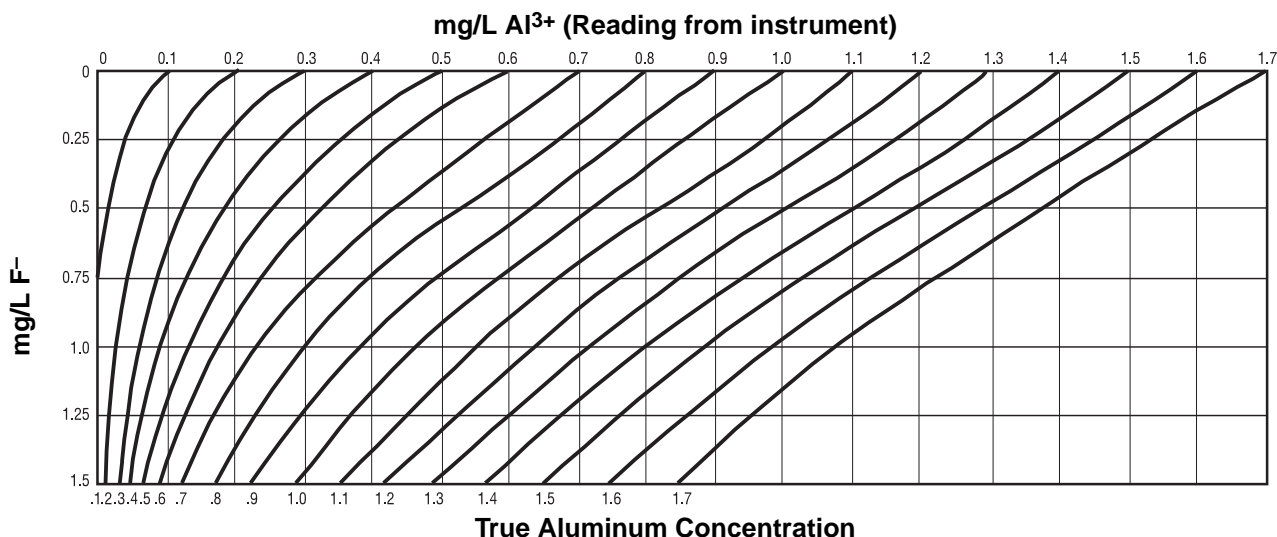

Sample Collection, Storage, and Preservation

Collect samples in a clean glass or plastic containers. Preserve the sample by adjusting the pH to 2 or less with nitric acid (about 1.5 mL per liter). Preserved samples can be stored up to six months at room temperature. Before analysis, adjust the pH to 3.5–4.5 with 5.0 N Sodium Hydroxide. Correct the test result for volume additions.

Accuracy Check

Standard Additions Method (Sample Spike)

1. After reading test results, leave the sample cell (unspiked sample) in the instrument. Verify the chemical form.
2. Press **OPTIONS>MORE**. Press **STANDARD ADDITIONS**. A summary of the standard additions procedure will appear.
3. Press **OK** to accept the default values for standard concentration, sample volume, and spike volumes. Press **EDIT** to change these values. After values are accepted, the unspiked sample reading will appear in the top row.
4. Open an Aluminum Voluette[®] Ampule Standard, 50-mg/L Al.
5. Prepare three sample spikes. Fill three mixing cylinders (Cat. No. 1896-41) with 50 mL of sample. Use the TenSette[®] Pipet to add 0.1 mL, 0.2 mL, and 0.3 mL of standard, respectively, to each sample and mix thoroughly.
6. Analyze each sample spike as described in the procedure above, starting with the 0.1 mL sample spike. Accept each standard additions reading by pressing **READ**. Each addition should reflect approximately 100% recovery.
7. After completing the sequence, press **GRAPH** to view the best-fit line through the standard additions data points, accounting for matrix interferences. Press **IDEAL LINE** to view relationships between the sample spikes and the "Ideal Line" of 100% recovery.

Standard Solution Method

1. Prepare a 0.4-mg/L aluminum standard solution as follows: Pipet 1.00 mL of Aluminum Standard Solution, 100-mg/L as Al^{3+} , into a 250-mL volumetric flask.
2. Dilute to the mark with deionized water. Prepare this solution daily. Perform the aluminum procedure as described above.

Or, use the following alternative procedure:

1. Using the TenSette Pipet, add 0.8 mL of solution from an Aluminum Voluette Ampule Standard Solution (50-mg/L as Al) into a 100-mL volumetric flask.
2. Dilute to volume with deionized water. Perform the aluminum procedure as described.
3. To adjust the calibration curve using the reading obtained with the standard solution, press **OPTIONS>MORE** on the current program menu. Press **STANDARD ADJUST**.
4. Press **ON**. Press **ADJUST** to accept the displayed concentration. If an alternate concentration is used, press the number in the box to enter the actual concentration, then press **OK**. Press **ADJUST**.

Summary of Method

Aluminon indicator combines with aluminum in the sample to form a red-orange color. The intensity of color is proportional to the aluminum concentration. Ascorbic acid is added to remove iron interference. The AluVer 3 Aluminum Reagent, packaged in powder form, shows exceptional stability and is applicable for fresh water applications. Test results are measured at 522 nm.

Consumables and Replacement Items**Required Reagents**

Description	Quantity/Test	Unit	Cat. No.
Aluminum Reagent Set (100 Tests), includes:	—	—	22420-00
(1) AluVer® 3 Aluminum Reagent Powder Pillow	1	100/pkg	14290-99
(1) Ascorbic Acid Powder Pillow	1	100/pkg	14577-99
(1) Bleaching 3 Reagent Powder Pillow	1	100/pkg	14294-49
Hydrochloric Acid, 6.0 N	varied	500 mL	884-49
Water, deionized	varied	4 L	272-56

Required Apparatus

Description	Quantity/Test	Unit	Cat. No.
Cylinder, graduated mixing, 50-mL, with glass stopper	1	each	1896-41
Sample Cell, 1-inch square, 10-mL matched pair	2	2/pkg	24954-02

Recommended Standards

Description	Unit	Cat. No.
Aluminum Standard Solution, 100-mg/L as Al ³⁺	100 mL	14174-42
Aluminum Standard Solution, 10-mL Voluette® Ampule, 50-mg/L as Al	16/pkg	14792-10

Optional Reagents

Description	Cat. No.
m-Nitrophenol Indicator Solution	2476-32
Nitric Acid Solution, 1:1	2540-49
Sodium Hydroxide Standard Solution, 5.0 N	2450-26
Sulfuric Acid Standard Solution, 5.25 N	2449-32



FOR TECHNICAL ASSISTANCE, PRICE INFORMATION AND ORDERING:
In the U.S.A. – Call toll-free 800-227-4224
Outside the U.S.A. – Contact the HACH office or distributor serving you.
On the Worldwide Web – www.hach.com; E-mail – techhelp@hach.com

HACH COMPANY
WORLD HEADQUARTERS
Telephone: (970) 669-3050
FAX: (970) 669-2932

Aluminum

Method 8326

Eriochrome Cyanine R Method¹

Powder Pillows

(0.002 to 0.250 mg/L Al³⁺)

Scope and Application: For water

¹ Adapted from *Standard Methods for the Examination of Water and Wastewater*.



Test Preparation

Before starting the test:

Clean all glassware with 6.0 N HCl and deionized water before use to remove contaminants from the glass.

Check the sample temperature. It must be between 20–25 °C (68 –77 °F) for accurate results.

For more accurate results, determine a reagent blank value for each new lot of reagent. Follow the procedure using deionized water in place of the sample. Subtract the reagent blank value from the final results or perform a reagent blank adjust.

Collect the following items:

Quantity

ECR Reagent Powder Pillow	1
ECR Masking Reagent Solution	1 drop
Hexamethylene-tetramine Buffer Reagent Powder Pillow	1
25-mL graduated mixing cylinder with glass stopper	1
Sample cells, 1-inch square, 10 mL	2

Note: Reorder information for consumables and replacement items is on page 6.

Powder Pillows

Method 8326



1. Press **STORED PROGRAMS**.

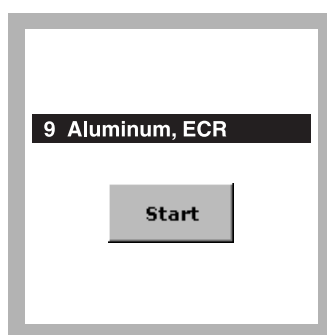

2. Select the test.

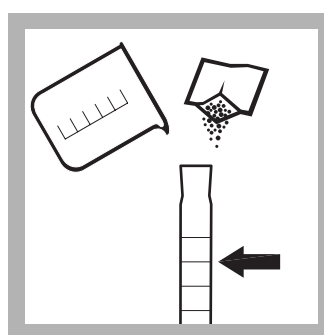

3. Fill the 25-mL mixing cylinder to the 20-mL mark with sample. Add one ECR Reagent Powder Pillow for 20-mL sample size.

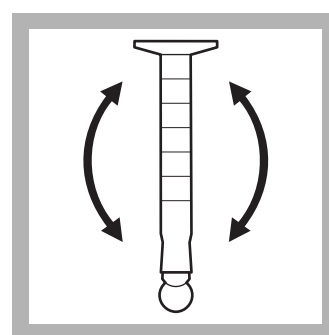

4. Insert the stopper. Invert several times to completely dissolve powder.

Undissolved reagent will cause inconsistent results.

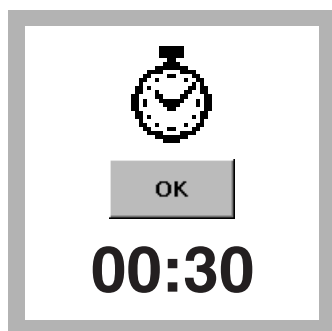

5. Press **TIMER>OK**.
A 30-second reaction period will begin.

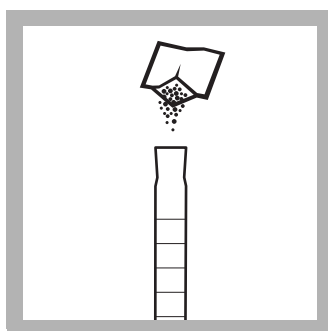

6. After the timer expires, add one Hexamethylenetetramine Buffer Reagent powder pillow.

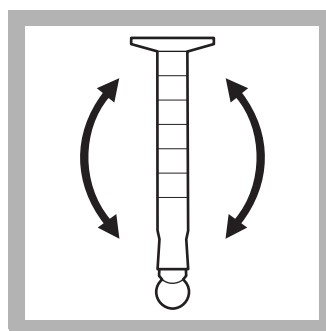

7. Insert the stopper. Invert several times to dissolve powder.
A red-orange color will develop if aluminum is present.

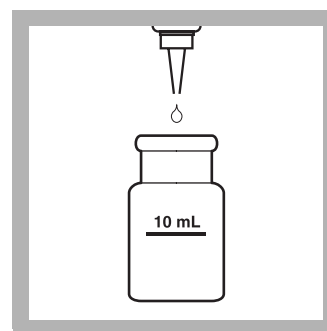

8. **Blank Preparation:**
Put one drop of ECR Masking Reagent Solution into a clean square sample cell.

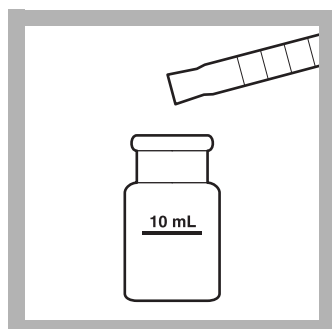

9. Pour 10 mL from the mixing cylinder into the blank cell. Swirl to mix.
The solution will begin to turn yellow.

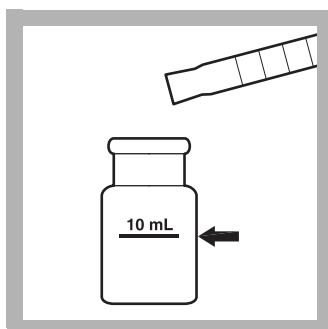

10. **Prepared Sample:**
Fill a second square sample cell to the 10-mL mark with the remaining solution in the cylinder.

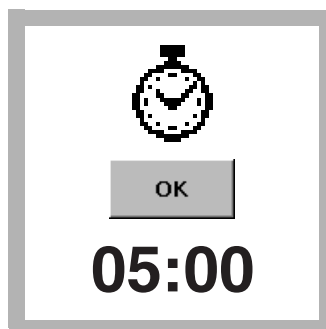

11. Press **TIMER>OK**.
A 5-minute reaction period will begin.



12. Within five minutes after the timer expires, wipe the blank then insert it into the cell holder with the fill line facing right.

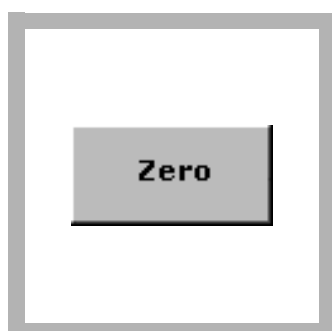

13. Press **ZERO**.
The display will show:
0.004 mg/L Al³⁺
This test uses a non-zero intercept for the calibration curve.



14. Immediately wipe and dry the prepared sample then insert it into the cell holder with the fill line facing right.

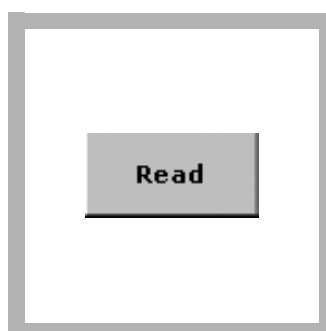

15. Press **READ**.
Results are in mg/L Al³⁺.

Interferences

Table 1 Interfering Substances and Levels

Interfering Substance	Interference Levels and Treatments
Acidity	Greater than 62 mg/L as CaCO ₃
Alkalinity	Greater than 750 mg/L as CaCO ₃
Ca ²⁺	Greater than 1000 mg/L as CaCO ₃
Cl ⁻	Greater than 1000 mg/L as CaCO ₃
Cr ⁶⁺	0.2 mg/L (error is -5% of reading)
Cu ²⁺	2 mg/L (error is -5% of reading)
Fe ²⁺	Greater than 4 mg/L (error is positive and equals mg/L Fe ²⁺ x 0.0075)
Fe ³⁺	Greater than 4 mg/L (error is positive and equals mg/L Fe ²⁺ x 0.0075)
F ⁻	See Table 2 on page 4.
Hexameta phosphate	0.1 mg/L as PO ₄ ³⁻ (error is -5% of reading)
Mg ²⁺	Greater than 1000 mg/L as CaCO ₃
Mn ²⁺	Greater than 10 mg/L
NO ₂ ⁻	Greater than 5 mg/L
NO ₃ ⁻	Greater than 20 mg/L
pH	2.9–4.9 or 7.5–11.5. A sample pH between about 4.9 and 7.5 causes dissolved aluminum to partially convert to colloidal and insoluble forms. This method measures much of that hard-to-detect aluminum without any pH adjusting pretreatment as is necessary in some other methods.
PO ₄ ³⁻ (ortho)	4 mg/L (error is -5% of reading)
Polyphosphate	See procedure below.
SO ₄ ²⁻	Greater than 1000 mg/L
Zn ²⁺	Greater than 10 mg/L

Polyphosphate interference can be reduced by converting polyphosphate to orthophosphate by the following steps:

- a. Rinse a 50-mL graduated mixing cylinder and a 125-mL Erlenmeyer flask containing a magnetic stir bar with 6 N hydrochloric acid*. Rinse again with deionized water. This will remove any aluminum present.

Note: Rinse two Erlenmeyer flasks if a reagent blank is used; see step b below.

- b. Measure 50 mL deionized water into the 125-mL Erlenmeyer flask using the graduated cylinder. This is the reagent blank. Because of the test sensitivity, this step must be done only when any of the reagents used in the following pretreatment are replaced—even if the new reagent has a matching lot number. When the pretreated sample has been analyzed, correct for the aluminum concentration of the reagent blank by pressing **OPTIONS>MORE**, then **REAGENT BLANK**. Press **ON**. Enter the reagent blank value and press **OK**.
- c. Measure 50 mL sample into the 125-mL Erlenmeyer flask using the graduated cylinder. Use a small amount of deionized water to rinse the cylinder contents into the flask.
- d. Add 4.0 mL of 5.25 N Sulfuric Acid Standard Solution*.

* See [Optional Reagents on page 6](#) for reorder information.

Aluminum (0.002 to 0.250 mg/L Al³⁺)

- e. Use a combination hot plate/stirrer to boil and stir the sample for at least 30 minutes. Add deionized water as needed to maintain a sample volume of 20-40 mL. Do not boil dry.
- f. Cool the solution to near room temperature.
- g. Add 2 drops of Bromphenol Blue Indicator Solution*.
- h. Add 1.5 mL of 12.0 N Potassium Hydroxide Standard Solution* using the calibrated, plastic dropper provided. Swirl to mix. The solution color should be yellow or green but not purple. If the color is purple, begin with step a again using an additional 1 mL Sulfuric Acid Standard Solution in step d.
- i. While swirling the flask, add 1.0 N Potassium Hydroxide Solution*, a drop at a time, until the solution turns a dirty green color.
- j. Pour the solution into the graduated cylinder. Rinse the flask contents into the graduated cylinder with deionized water to bring the total volume to 50 mL.
- k. Use this solution in step 3 of the ECR method.

Fluoride interference can be corrected by using [Table 2](#).

Example:

If the fluoride concentration is known to be 1.00 mg/L F⁻ and the ECR method gives a reading of 0.060 mg/L aluminum, what is the true mg/L aluminum concentration?

Intermediate values can be found by interpolation. Do not use correction graphs or charts found in other publications.

Answer: 0.183 mg/L

Table 2 Fluoride Concentration (mg/L)

(mg/L)	0.00	0.20	0.40	0.60	0.80	1.00	1.20	1.40	1.60	1.80	2.00
0.000	0.000	0.000	0.000	0.000	0.000	0.000	0.000	0.000	0.000	0.000	0.000
0.010	0.010	0.019	0.030	0.040	0.052	0.068	0.081	0.094	0.105	0.117	0.131
0.020	0.020	0.032	0.046	0.061	0.077	0.099	0.117	0.137	0.152	0.173	0.193
0.030	0.030	0.045	0.061	0.077	0.098	0.124	0.146	0.166	0.188	0.214	0.243
0.040	0.040	0.058	0.076	0.093	0.120	0.147	0.174	0.192	0.222	—	—
0.050	0.050	0.068	0.087	0.109	0.135	0.165	0.188	0.217	—	—	—
0.060	0.060	0.079	0.100	0.123	0.153	0.183	0.210	0.241	—	—	—
0.070	0.070	0.090	0.113	0.137	0.168	0.201	0.230	—	—	—	—
0.080	0.080	0.102	0.125	0.152	0.184	0.219	—	—	—	—	—
0.090	0.090	0.113	0.138	0.166	0.200	0.237	—	—	—	—	—
0.100	0.100	0.124	0.150	0.180	0.215	—	—	—	—	—	—
0.120	0.120	0.146	0.176	0.209	0.246	—	—	—	—	—	—
0.140	0.140	0.169	0.201	0.238	—	—	—	—	—	—	—
0.160	0.160	0.191	0.226	—	—	—	—	—	—	—	—
0.180	0.180	0.213	—	—	—	—	—	—	—	—	—
0.200	0.200	0.235	—	—	—	—	—	—	—	—	—
0.220	0.220	—	—	—	—	—	—	—	—	—	—
0.240	0.240	True Aluminum Concentration (mg/L) Al									

* See [Optional Reagents on page 6](#) for reorder information.

Sample Collection, Storage, and Preservation

Collect samples in clean glass or plastic containers. Preserve samples by adjusting the pH to 2 or less with concentrated nitric acid* (about 1.5 mL per liter). Preserved samples can be stored up to six months at room temperature. Before analysis, adjust the pH to 2.9–4.9 with 12.0 N Potassium Hydroxide Standard Solution* and/or 1 N Potassium Hydroxide Solution*. Correct the test result for volume additions.

Accuracy Check

Standard Additions Method (Sample Spike)

Standard Solution Method

Prepare a 0.100 mg/L aluminum standard solution as follows:

1. Using Class A glassware, pipet 1.00 mL of Aluminum Standard Solution.

100-mg/L as Al³⁺, into a 1000-mL volumetric flask. Dilute to the mark with deionized water. Prepare this solution daily. Perform the aluminum procedure as described above.

OR

Add 2.0 mL of solution from an Aluminum Voluette® Ampule Standard Solution (50-mg/L as Al) into a 1000-mL volumetric flask. Dilute to volume with deionized water. Prepare this solution daily. Perform the aluminum procedure as described above.

2. To adjust the calibration curve using the reading obtained with the standard solution, press **OPTIONS>MORE** on the current program menu. Press **STANDARD ADJUST**.
3. Press **ON**. Press **ADJUST** to accept the displayed concentration. If an alternate concentration is used, press the number in the box to enter the actual concentration, then press **OK**. Press **ADJUST**.

Summary of Method

Eriochrome Cyanine R combines with aluminum in a sample to produce an orange-red color. The intensity of color is proportional to the aluminum concentration. Test results are measured at 535 nm.

*See [Optional Reagents on page 6](#).

Aluminum (0.002 to 0.250 mg/L Al³⁺)

Consumables and Replacement Items

Required Reagents

Description	Quantity/Test	Unit	Cat. No.
Aluminum Reagent Set (100 Tests), includes:	—	—	26037-00
ECR Reagent Powder Pillows	1	100/pkg	26038-49
Hexamethylenetetramine Buffer Reagent Powder Pillows	1	100/pkg	26039-99
ECR Masking Reagent Solution	1 drop	25 mL SCDB	23801-23

Required Apparatus

Description	Quantity/Test	Unit	Cat. No.
Cylinder, graduated mixing, 25-mL, with glass stopper	1	each	1896-40
Sample Cell, 1-inch Square, 10 mL	2	2/pkg	24954-02
Thermometer, -10 to 110 °C	—	each	1877-01

Recommended Standards

Description	Unit	Cat. No.
Aluminum Standard Solution, 100-mg/L as Al ³⁺	100 mL	14174-42
Aluminum Standard Solution, 10-mL Voluette® Ampule, 50-mg/L as Al	16/pkg	14792-10
Water, deionized	4 L	272-56

Optional Reagents

Description	Unit	Cat. No.
Bromphenol Blue Indicator Solution	100 mL	14552-32
Hydrochloric Acid, 6.0 N	500 mL	884-49
Nitric Acid 1:1	500 mL	2540-49
Potassium Hydroxide Standard Solution, 12.0 N	100 mL	230-32
Potassium Hydroxide Solution, 1.0 N	50 mL	23144-26
Sodium Hydroxide Standard Solution, 5.0 N	50 mL	2450-26
Sulfuric Acid Standard Solution, 5.25 N	100 mL	2449-32



FOR TECHNICAL ASSISTANCE, PRICE INFORMATION AND ORDERING:
In the U.S.A. – Call toll-free 800-227-4224
Outside the U.S.A. – Contact the HACH office or distributor serving you.
On the Worldwide Web – www.hach.com; E-mail – techhelp@hach.com

HACH COMPANY
WORLD HEADQUARTERS
Telephone: (970) 669-3050
FAX: (970) 669-2932

Aluminum

Method 10215

TNTplus™ 848

Chromazurol S Method

(0.02 to 0.50 mg/L Al)

Scope and Application: For drinking water, surface water, swimming pool water, wastewater, and process analysis.



Test Preparation

Before starting the test:

Important Note: Install the light shield in Cell Compartment #2 before performing this test.

Please read the Safety Advice and Expiration Date on the package.

Recommended sample pH is 2.5–3.5.

Recommended sample and reagent temperature is 20–23 °C (68–73.4 °F).

Recommended reagent storage is 15–25 °C (59–77 °F).

If test is not performed at the recommended temperature an incorrect result may be obtained.

A higher pH causes precipitation or complexing of the aluminum so that low-bias results are obtained. If necessary the pH of the sample must be adjusted by adding a small amount of nitric acid.

TNTplus methods are activated directly from the Main Menu screen when the prepared sample vial is inserted into the sample cell holder.

Collect the following items:

Quantity

Aluminum TNT848 Reagent Set	1
Light Shield	1
Pipettor, variable 1–5 mL	1
Pipettor tips for 1–5 mL pipettor	1

Note: Reorder information for consumables and replacement items is on page 4.

TNTplus

Method 10215

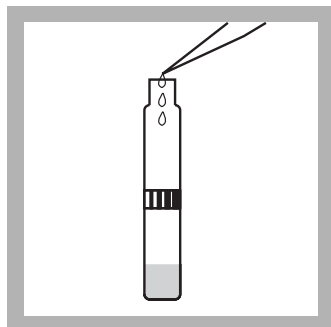

1. Pipet 2.0 mL of Solution A into the vial.

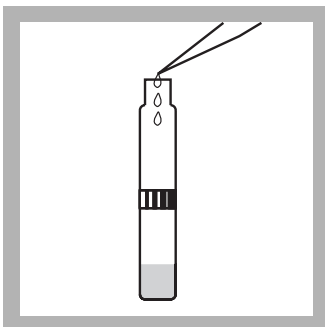

2. Pipet 3.0 mL of sample into the vial.

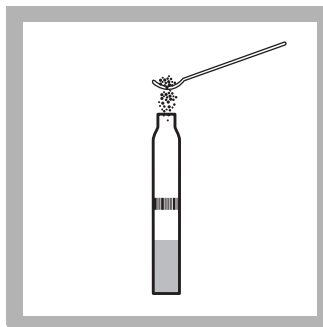

3. Add one level spoonful of Reagent B to the vial.

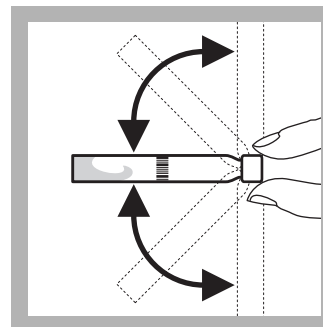

4. Cap and invert the vial 2–3 times until no more streaks can be seen in the solution.



5. Wait 25 minutes.
Install the Light Shield in Cell Compartment #2.



6. Insert the Zero vial from the sample vial lot into the sample cell holder.

The instrument reads the barcode, then selects the method and sets the instrument to zero. The instrument displays L1 when zeroing is complete.

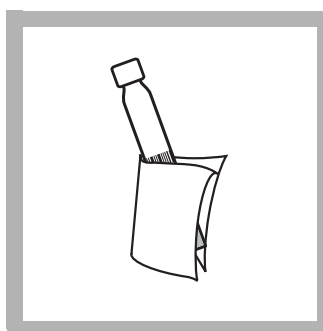

7. Thoroughly clean the outside of the prepared sample vial.



8. Insert the prepared vial into the cell holder. The instrument reads the barcode and reads the sample.

Results are in mg/L Al.

Reagent Blanks

A reagent blank can be measured, and the value subtracted from the results of each test performed using the same reagent lot number. Use deionized water in place of sample and run the procedure as described.

To subtract the value of the blank from a series of measurements, measure the blank per step 6. Press **OPTIONS>MORE>REAGENT BLANK**. Press **ON**. The measured value of the blank should be displayed in the highlighted box. Press **OK** to accept this value. The reagent blank value will now be subtracted from all results until the function is turned off, or a different method is selected. Alternately, the blank can be recorded and entered at any later time by pressing the highlighted box and using the keypad to enter the value.

Sample Blanks

If the Sample Blank value falls within the allowable range, this value will be used to correct the result automatically. The instrument will subtract the Sample Blank from the uncorrected result. Samples without color or turbidity do not require sample blanks.

Interferences

The ions listed in [Table 1](#) have been individually checked up to the given concentrations and do not cause interference. Cumulative effects and the influence of other ions have not been determined.

Higher concentrations of heavy metals than those given, as well as fluoride, phosphate and relatively rare elements such as e.g. beryllium, thorium, titanium, zirconium and vanadium interfere with the determination. Aluminum oxide hydrates and hydroxide are only partially determined.

Measurement results can be verified using sample dilutions or standard additions.

Table 1 Interfering Substances and Levels

Interfering Substance	Interference Level
Mg ²⁺ , K ⁺ , Na ⁺ , NH ₄ ⁺ , Cl ⁻ , NO ₃ ⁻ , SO ₄ ²⁻ , Ca ²⁺	500 mg/L
Ag ⁺ , Mn ²⁺	100 mg/L
Cd ²⁺ , Co ²⁺ , Ni ²⁺ , Sn ²⁺ , Pb ²⁺ , PO ₄ ³⁻	50 mg/L
Cu ²⁺ , Hg ²⁺	10 mg/L
Fe ²⁺ , Fe ³⁺ , Zn ²⁺ , Si ⁴⁺	5 mg/L
Cr ³⁺ , Cr ⁶⁺	0.5 mg/L
F ⁻	0.1 mg/L

Sample Collection, Preservation, and Storage

Collect samples in an acid-washed glass or plastic containers. Adjust the pH to 2 or less with nitric acid (about 2 mL per liter). Store preserved samples up to six months at room temperature. Adjust the pH to between 2.5 and 3.5 with 5.0 N sodium hydroxide before analysis. Correct the test result for volume additions.

Accuracy Check

Standard Solution Method

1. Prepare a 0.4 mg/L aluminum standard solution by pipetting 1.0 mL of a 100 mg/L aluminum standard solution into a 250 mL volumetric flask.
2. Dilute to volume with deionized water. Prepare this solution daily. Use 3.0 mL of this standard in place of the sample in the procedure.

Summary of Method

Chromazurol S forms a green colored lake with aluminum in weakly acidic acetate-buffered solutions. The amount of color formed is directly proportional to the amount of aluminum present in the sample. Test results are measured at 620 nm.

Consumables and Replacement Items

Required Reagents

Description	Quantity/Test	Unit	Cat. No.
Aluminum TNT 848 Reagent Set	1	24/pkg	TNT848

Required Apparatus

Description	Quantity/Test	Unit	Cat. No.
Light Shield	1	each	LZV646
Pipettor, variable volume, 1–5 mL	1	each	27951-00
Pipettor Tips, for 27951-00 pipettor	1	100/pkg	27952-00

Recommended Reagents and Standards

Description	Unit	Cat. No.
Aluminum Standard Solution, 100 mg/L	100 mL	14174-42
Nitric Acid, ACS	500 mL	152-49
Sodium Hydroxide Standard Solution, 5.0 N	100 mL MDB	2450-32
Sodium Hydroxide Standard Solution, 5.0 N	59 mL SCDB	2450-26
Water, deionized	4 L	272-56

Optional Reagents and Apparatus

Description	Unit	Cat. No.
Bottle, Sampling, low density poly, w/cap, 500 mL	12/pk	20870-79
Flask, volumetric 250 mL	each	14574-46
Pipet, volumetric 1.0 mL	each	14515-35
Test Tube Rack, 13-mm vials	each	24979-00
Vials, sample blank	—	TNT919



FOR TECHNICAL ASSISTANCE, PRICE INFORMATION AND ORDERING:
 In the U.S.A. – Call toll-free 800-227-4224
 Outside the U.S.A. – Contact the HACH office or distributor serving you.
 On the Worldwide Web – www.hach.com; E-mail – techhelp@hach.com

HACH COMPANY
 WORLD HEADQUARTERS
 Telephone: (970) 669-3050
 FAX: (970) 669-2932

Scope and Application: For water, wastewater, and seawater; distillation is required; USEPA accepted² for reporting for drinking and wastewater analysis (digestion required)

¹ Adapted from *Standard Methods for the Examination of Water and Wastewater*.

² Procedure is equivalent to USEPA Method 206.4 for wastewater and Standard Method 3500-As for drinking water analysis.



Test Preparation

Before starting the test:

Create a user-entered program for arsenic. See step 1 and [User Programming on page 5](#).

Prepare the arsenic absorber solution as directed in [Reagent Preparation on page 4](#).

Perform a user-entered calibration for each new lot of arsenic absorber solution. See [Calibration on page 5](#). Some variations of the calibration procedure are possible.

In bright light conditions (e.g. direct sunlight) it may be necessary to close the cell compartment with the protective cover during measurements.

Collect the following items:

Quantity

Apparatus as listed on page 6.	—
Arsenic Standard Solution, 1000-mg/L As	varies
Hydrochloric Acid, ACS	25 mL
Lead Acetate Solution, 10%	1 mL
Potassium Iodide Solution, 20%	3 mL
Pyridine, ACS	50 mL
Sample Cells, 1-inch square, 25 mL, matched pair with stopper	2
Silver Diethyldithiocarbamate	1 g
Stannous Chloride Solution	1 mL
Water, deionized	varies
Zinc, 20-mesh, ACS	6 g

Note: Reorder information for consumables and replacement items is on page 6.

Important Note: The arsenic absorber in this test is a silver solution in pyridine. Both silver (D011) and pyridine (D038) are regulated by the Federal RCRA as hazardous waste. In addition, the cotton ball soaked in lead acetate (D008) solution is a hazardous waste. These materials should not be poured down the drain. Refer to a current MSDS sheet for proper disposal.

Silver Diethyldithiocarbamate

Method 8013

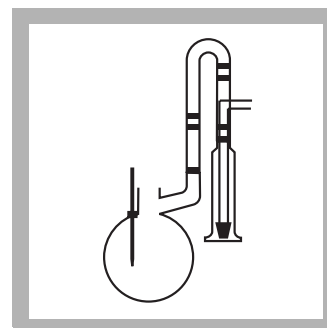
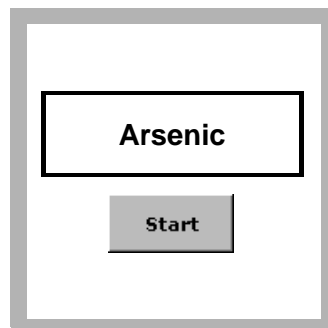

1. Perform the [User Programming](#) procedure on page 5. Make note of the program number.

2. To run the test, press **USER PROGRAMS**.

3. Select the test.

4. Prepare the Distillation Apparatus for arsenic recovery. See the *Distillation Manual* for assembly instructions. Place it under a fume hood to vent toxic fumes.

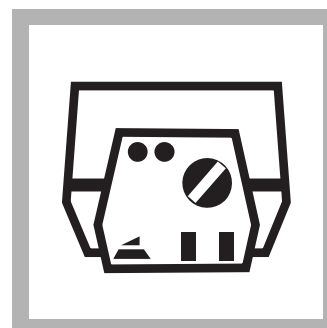
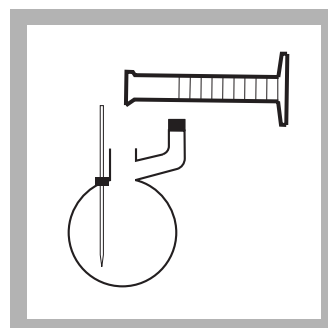
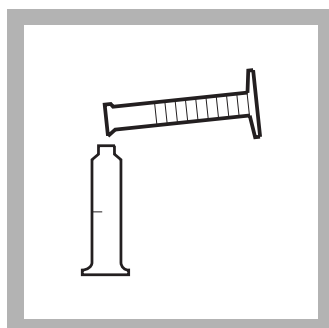
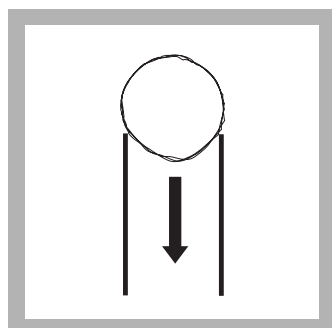

5. Dampen a cotton ball with 10% Lead Acetate Solution. Insert it in the gas scrubber. Be certain that the cotton seals against the glass.

6. Using a graduated cylinder, pour 25-mL of prepared arsenic absorber solution ([Reagent Preparation on page 4](#)) into the cylinder/gas bubbler assembly.

Attach it to the distillation apparatus.

7. Using a graduated cylinder, pour 250 mL of sample into the distillation flask.

8. Turn on the power switch. Set the stir control to 5. Set the heat control to 0.

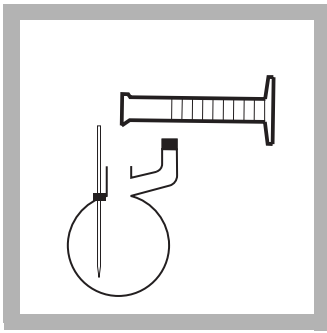

9. Using a graduated cylinder, add 25 mL of Hydrochloric Acid, ACS, to the distillation flask.

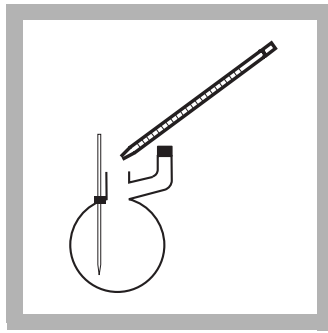

10. Use a serological pipet to add 1 mL of Stannous Chloride Solution to the flask.

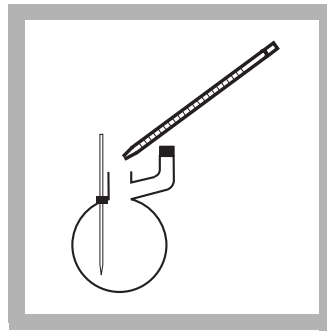

11. Use a serological pipet to add 3 mL of Potassium Iodide Solution to the flask. Cap.



12. Press **TIMER>OK**. A 15-minute reaction period will begin.

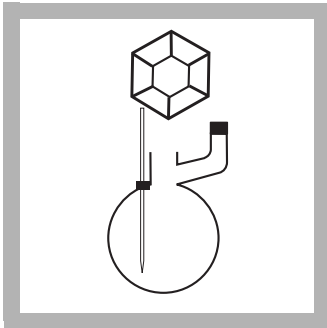

13. When the timer expires, add 6.0 g of 20-mesh zinc to the flask. **Cap immediately.**



14. Set the heat control to 3.



15. Press **TIMER>OK**. A second 15-minute reaction period will begin.



16. When the timer expires, set the heat control to 1.

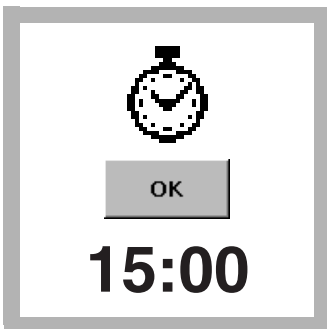

17. Press **TIMER>OK**. A third 15-minute reaction period will begin.

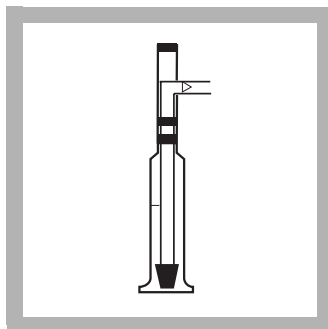

18. When the timer expires, turn off the heater. Remove the cylinder/gas bubbler assembly as a unit.

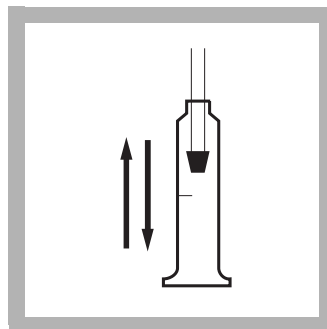

19. Rinse the gas bubbler by moving it up and down in the arsenic absorber solution.

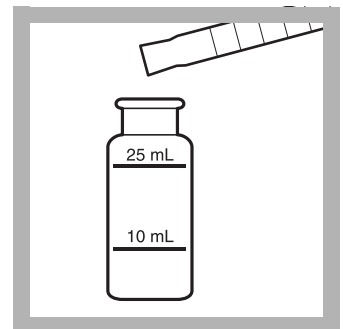

20. **Blank Preparation:** Fill a dry, 25-mL square sample cell with untreated arsenic absorber solution. Stopper.



21. Wipe the blank and insert it into the cell holder with the fill line facing right.

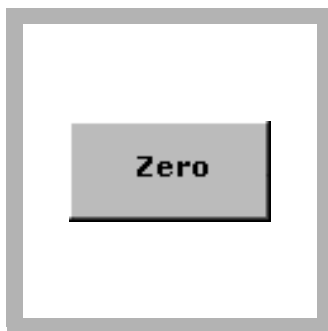

22. Press **ZERO**. The display will show the intercept as calculated from the user-entered calibration curve. This will probably be a non-zero intercept.

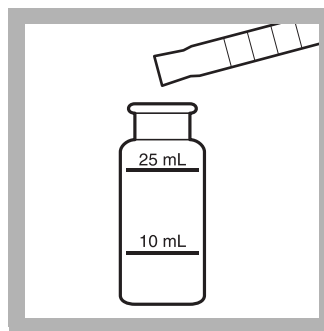

23. **Prepared Sample:** Pour the reacted arsenic absorber sample into a sample cell. If the solution volume is less than 25 mL, add pyridine to bring the volume to exactly 25 mL. Stopper.

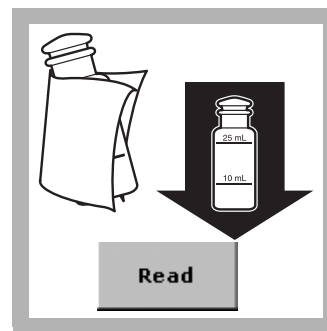

24. Wipe the prepared sample and insert it into the cell holder with the fill line facing right. Press **READ** to display the results.

Interferences

Table 1 Interfering Substances and Levels

Interfering Substance	Interference Levels and Treatments
Antimony Salts	May interfere with color development.

Sample Collection, Storage, and Preservation

Collect samples in acid washed glass or plastic bottles. Adjust the pH to 2 or less with sulfuric acid (about 2 mL per liter)*. Preserved samples may be stored up to six months at room temperature. Correct the test result for volume additions.

Reagent Preparation

Prepare the arsenic absorber solution as follows:

1. Weigh 1.00 g of silver diethyldithiocarbamate on an analytical balance.
2. Transfer the powder to a 200-mL volumetric flask. Dilute to volume with pyridine. **Use pyridine only in a fume hood and wear chemical resistant gloves.** Read the MSDS before using pyridine.
3. Mix well to dissolve. Store the reagent, tightly sealed, in an amber bottle. The reagent is stable for one month if stored in this manner. Larger volumes of reagent can be prepared if the reagent is used within one month.

* See [Optional Reagents and Apparatus on page 7](#).

Calibration

Standard Preparation

Perform a new calibration for each lot of arsenic absorber solution.

1. Prepare a 10.0-mg/L arsenic working standard by pipetting 10.0 mL of Arsenic Standard Solution, 1000 mg/L As into a 1000-mL volumetric flask.
2. Dilute to volume with deionized water.
3. Into three different 500-mL volumetric flasks, pipet 1.0, 2.0, and 10.0 mL of the 10.0 mg/L As stock solution using Class A glassware.
4. Dilute to the mark with deionized water and mix thoroughly. These standards have concentrations of 0.02, 0.04 and 0.20 mg/L As.

User Programming

1. Press **USER PROGRAMS** on the main menu.
2. If you have not performed an arsenic calibration before, press **PROGRAM OPTIONS** and **NEW**. Key any available program number (950–999) to use for arsenic testing. Press **OK**.
3. Fill in the appropriate fields using the touch screen when the field is highlighted. Use the alphanumeric keys to name the User Program **ARSENIC**. Press **NEXT** to move to the next screen. Set up the rest of the parameters as follows:
 - Program Type: Single Wavelength
 - Units: mg/L
 - Concentration Resolution: 0.001
 - Chemical Form: As
 - Wavelength: 520 nm
 - Calibration: Read Standards
4. After entering Read Standards, press **NEXT>EXIT**. Fill in the appropriate fields for each of the following. Use the touch screen to activate the parameter and press **EDIT** to enter the data entry screen. Set up the rest of the parameters as follows:
 - Timer1: 15 minutes
 - Timer2: 15 minutes
 - Timer3: 15 minutes
 - Upper Limit: 0.220 mg/L
 - Lower Limit: –0.020 mg/L
5. Press **CALIBRATION: C = A + BA**. Press **EDIT**.
6. The Read Standards will be indicated. Enter the standards concentration values to be used to perform the calibration: 0.00, 0.02, 0.04, and 0.20. To enter the concentration values press **+** and enter the value followed by **OK** for each concentration value.
7. After the values are entered, press the **UP** arrow four times to move the cursor to the 0.00 concentration line.
8. Insert the 25-mL sample cell containing only unreacted arsenic absorber solution into the cell holder. Press **ZERO**.

9. Press the **DOWN** arrow once to move to the next concentration. Insert the prepared sample in the cell holder. Press **READ** to accept the absorbance value. Repeat steps for each standard.
10. Press **GRAPH**. Make sure **FORCE ZERO** is off.
11. If the graph is acceptable press **DONE>EXIT**.
12. "Store Program?" will appear on the display. Press **YES**.

The program is ready for use.

Some variations of the calibration procedure are possible. See the user manual for details.

Summary of Method

Arsenic is reduced to arsine gas by a mixture of zinc, stannous chloride, potassium iodide, and hydrochloric acid in a specially equipped distillation apparatus. The arsine is passed through a scrubber containing cotton saturated with lead acetate and then into an absorber tube containing silver diethyldithiocarbamate in pyridine. The arsenic reacts to form a red complex which is read colorimetrically. This procedure requires a manual calibration. Test results are measured at 520 nm.

Consumables and Replacement Items

Required Reagents

Description	Quantity/Test	Unit	Cat. No.
Arsenic Standard Solution, 1000-mg/L As	varies	100 mL	14571-42
Hydrochloric Acid, ACS	25 mL	500 mL	134-49
Lead Acetate Solution, 10%	1 mL	100 mL	14580-42
Potassium Iodide Solution, 20%	3 mL	100 mL	14568-42
Pyridine, ACS	50 mL	500 mL	14469-49
Silver Diethyldithiocarbamate	1 g	25 g	14476-24
Stannous Chloride Solution	1 mL	100 mL	14569-42
Water, deionized	varies	4 liters	272-56
Zinc, 20-mesh, ACS	6 g	454 g	795-01

Required Apparatus

Description	Quantity/Test	Unit	Cat. No.
Balance, analytical, SL 3000, 100–240 V	1	each	28018-00
Balls, cotton	1	100/pkg	2572-01
Boat, weighing, 8.9-cm square	2	500/pkg	21790-00
Bottle, amber, 237-mL, glass	1	6/pkg	7144-41
Cap, polypropylene, for amber bottle	1	6/pkg	21667-06
Cylinder, graduated, 25-mL	2	each	508-40
Cylinder, graduated, 250-mL	1	each	508-46
Distillation Apparatus, Arsenic Accessories	1	set	22654-00
Distillation Apparatus, General Purpose Accessories	1	set	22653-00
Flask, volumetric, Class A, 1000-mL, with glass stopper	1	each	14574-53
Flask, volumetric, Class A, 200-mL	1	each	14574-45

Required Apparatus (continued)

Description	Quantity/Test	Unit	Cat. No.
Flask, volumetric, Class A, 500-mL	6	each	14574-49
Pipet Filler, safety bulb	1	each	14651-00
Pipet, serological, 5-mL	2	each	532-37
Pipet, volumetric, Class A, 1.00-mL	2	each	14515-35
Pipet, volumetric, Class A, 2.00-mL	1	each	14515-36
Pipet, volumetric, Class A, 4.00-mL	1	each	14515-04
Pipet, volumetric, Class A, 6.00-mL	1	each	14515-06
Pipet, volumetric, Class A, 8.00-mL	1	each	14515-08
Pipet, volumetric, Class A, 10.00-mL	1	each	14515-38
Sample Cells, 1-inch square, 25 mL, matched pair with stopper	2	2/pkg	26126-02
Select one based on available voltage:			
Distillation Apparatus Heater, 115 VAC, 60 Hz	1	each	22744-00
Distillation Apparatus Heater, 230 VAC, 50 Hz	1	each	22744-02

Optional Reagents and Apparatus

Description	Cat. No.
Cylinder, mixing, 25-mL	1896-40
Sulfuric Acid, 1.00 N	1270-32
Gloves, Chemical Resistant, size 9 ¹	24101-04

¹ Other sizes available.



FOR TECHNICAL ASSISTANCE, PRICE INFORMATION AND ORDERING:

In the U.S.A. – Call toll-free 800-227-4224
Outside the U.S.A. – Contact the HACH office or distributor serving you.
On the Worldwide Web – www.hach.com; E-mail – techhelp@hach.com

HACH COMPANY
WORLD HEADQUARTERS
Telephone: (970) 669-3050
FAX: (970) 669-2932

Method 10050

Immunoassay Method¹

Scope and Application: For water

¹ This test is semi-quantitative. Results are expressed as greater or less than the threshold value used.



Test Preparation

This method analyzes for Atrazine in water. Sample calibrators and reagents are added to cuvettes coated with Atrazine-specific antibodies. The color that develops is then measured and compared with the color measurements of the calibrators. The test requires about 30 minutes for complete analysis. As many as 20 cuvettes (18 samples and 2 calibrators) can be run simultaneously.

Before starting the test:

Read the entire procedure before starting. Identify and make ready all the necessary reagents, cuvettes, and other apparatus before beginning the analysis.

Timing is critical; follow instructions carefully.

A consistent technique when mixing the cuvettes is critical to this test. The best results come from using the cuvette rack and mixing as described in [Using the 1-cm MicroCuvette Rack on page 4](#). Cuvettes can be mixed individually, but test results may not be as consistent.

Handle the cuvettes carefully. Scratches on the inside or outside may cause erroneous results. Carefully clean the outside of the cuvettes with a clean absorbent cloth or tissue before placing them into the instrument.

Antibody cuvettes and enzyme conjugate are made in matched lots. Do not mix reagent lots.

To avoid damaging the Color Developing Solution, do not expose it to direct sunlight.

The cuvette rack is designed to be inverted with the cuvettes in place. This is especially helpful when running many samples at once; the cuvettes can remain in the rack and be processed together until they are read in the spectrophotometer.

Twenty Antibody Cuvettes are provided with each reagent set. One Antibody Cuvette will be used for each calibrator and each sample. Cuvettes are not reusable.

Protective nitrile gloves are recommended for this procedure.

Collect the following items:

Quantity

Atrazine Reagent Set	1
Caps, flip spout	1
Marker, laboratory	1
Rack, for 1-cm Micro Cuvettes	1
Wipes, disposable	1
Pipet, TenSette®, 0.1–1.0 mL	1
Pipet Tips, for TenSette Pipet 19700-01	1

Note: Reorder information for consumables and replacement items is on [page 7](#).

Immunoassay for Water

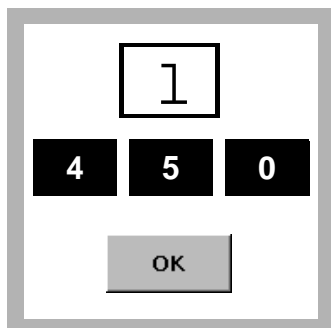

1. Press **SINGLE WAVELENGTH**
Press **OPTIONS** and the λ button. Enter **450 nm** and press **OK**.

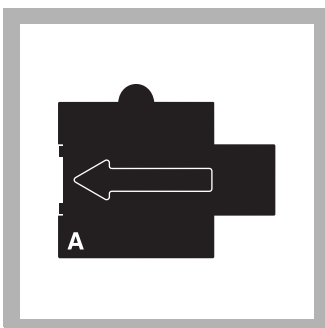

2. Insert Adapter A.

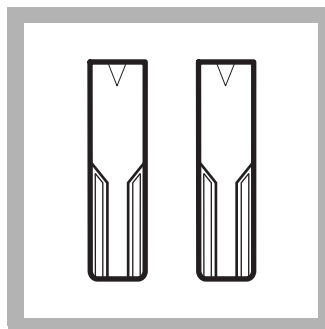

3. Label an Antibody Cuvette for each calibrator and each sample to be tested.

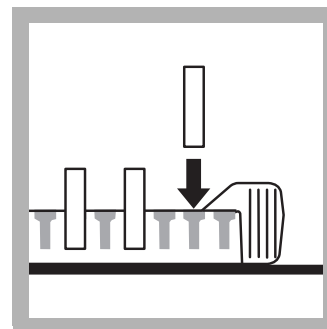

4. Insert the cuvettes into the rack snugly.

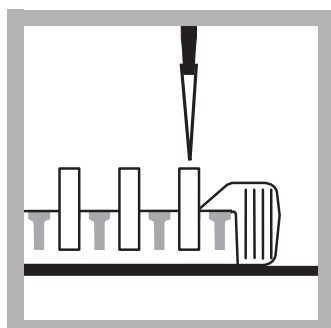

5. Pipet 0.5 mL of each calibrator into the appropriately labeled cuvette.
Use a new pipette tip for each calibrator.

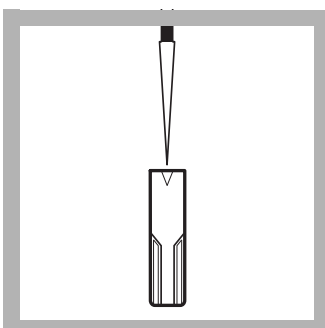

6. Pipet 0.5 mL of each sample to be tested into the appropriately labeled cuvette.
Use a new pipette tip for each sample.

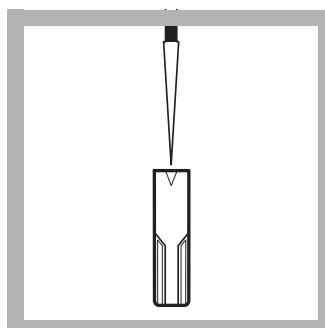

7. Immediately pipet 0.5 mL of Atrazine Enzyme Conjugate into each cuvette.

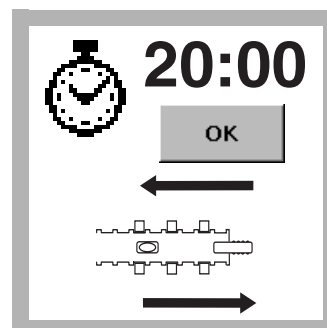

8. Press **OPTIONS**. Press **TIMER**. Enter 20:00 minutes and press **OK**.

A 20-minute reaction time will begin.

Immediately mix the contents of the cuvettes for 30 seconds ([Using the 1-cm MicroCuvette Rack on page 4.](#))

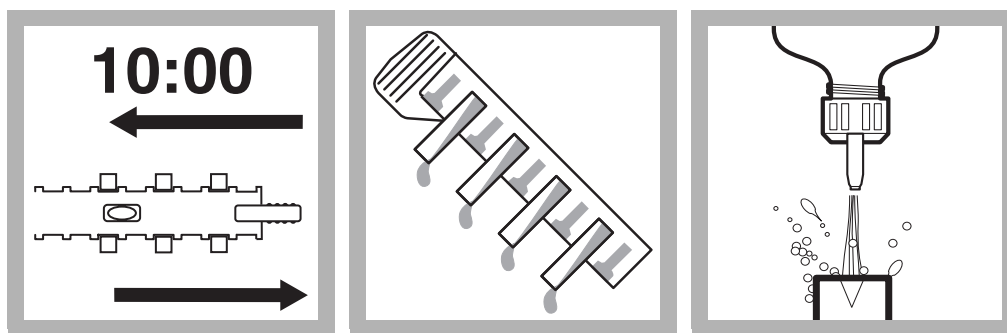

9. After 10 minutes mix the contents of the rack for 30 seconds (Using the [1-cm MicroCuvette Rack](#) on page 4.)

10. At the end of the 20-minute period, discard the contents of all the cuvettes into an appropriate waste container.

11. Wash each cuvette forcefully and thoroughly four times with deionized water. Empty the rinse water into the waste container.

Ensure that most of the water is drained from the cuvettes by turning the cuvettes upside down and tapping them lightly on a paper towel.

Color Development

Important Note: Timing is critical. Follow instructions carefully.

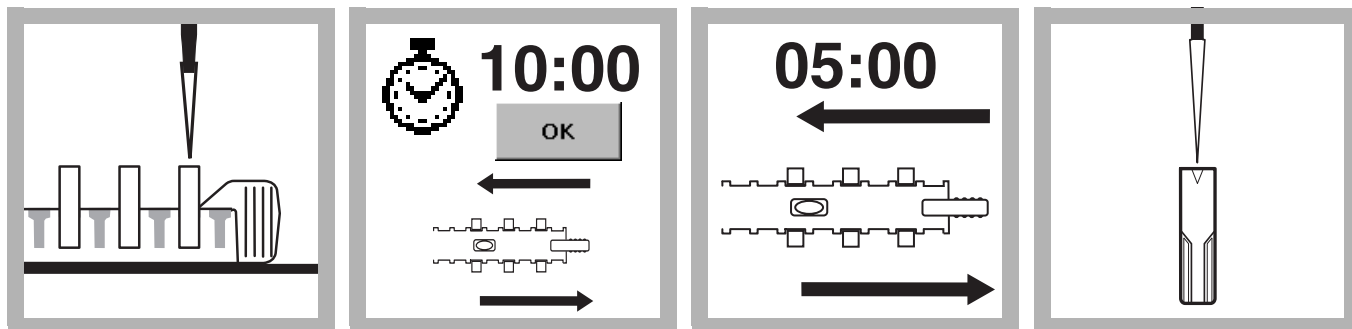

12. With the cuvettes still held snugly in the rack, pipet 0.5 mL of Color Developing Solution into each Antibody Cuvette. Use a new pipette tip for each cuvette.

13. Press **OPTIONS**. Press **TIMER**. Enter 10:00 minutes and press **OK**. A reaction period will begin. Mix, using the instructions on page 4.

14. After 5 minutes, mix the contents of the rack a second time for a period of 30 seconds using the same technique. Solutions will turn blue in some or all of the cuvettes.

15. At the end of the 10-minute reaction period, pipette 0.5 mL of Stop Solution into each cuvette in the same order as the Color Developing Solution was added in step 12. Use the same pipette tip repeatedly for this step.

Slide the rack for 20 seconds (Using the [1-cm MicroCuvette Rack](#) on page 4.)

Blue solutions will turn yellow with the addition of the Stop Solution.

Measuring the Color

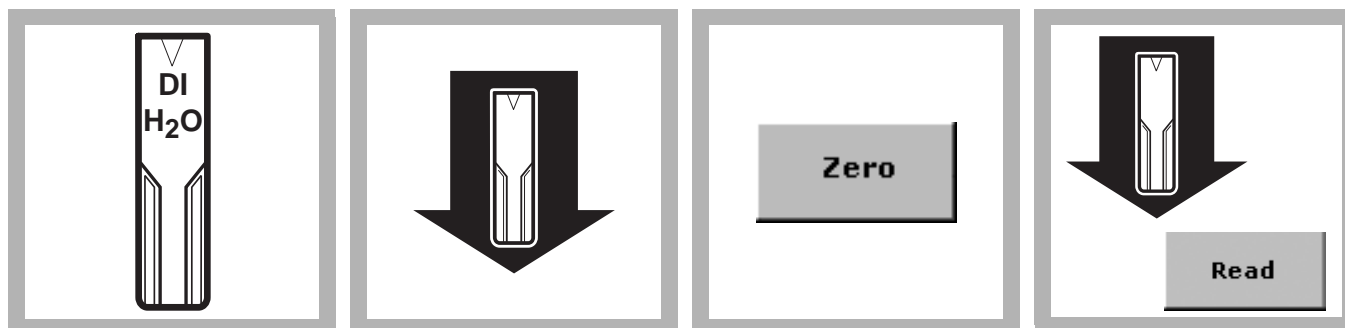

16. Label and fill a Zeroing Cuvette with deionized water. Wipe the outside of all the cuvettes with a tissue to remove water, smudges, and fingerprints.

17. Insert the filled Zeroing Cuvette into the cell holder—arrow pointing to the right. Orient the arrow in the same direction for all cuvettes.

18. Press **ZERO**.
The display will show:
0.000 Abs

19. Insert the first calibrator into the cell holder.
Press READ. The display will give an absorbance reading. Record the results for each calibrator and sample.
Repeat this step for all remaining calibrators and samples.
See [Interpreting and Reporting Results on page 5](#) for help with interpretation of results.

Using the 1-cm MicroCuvette Rack

The MicroCuvette rack ([Figure 1](#)) has been designed specifically to aid in achieving precise and accurate results when using the immunoassay technique to analyze several samples at the same time.

Figure 1 The 1-cm MicroCuvette Rack

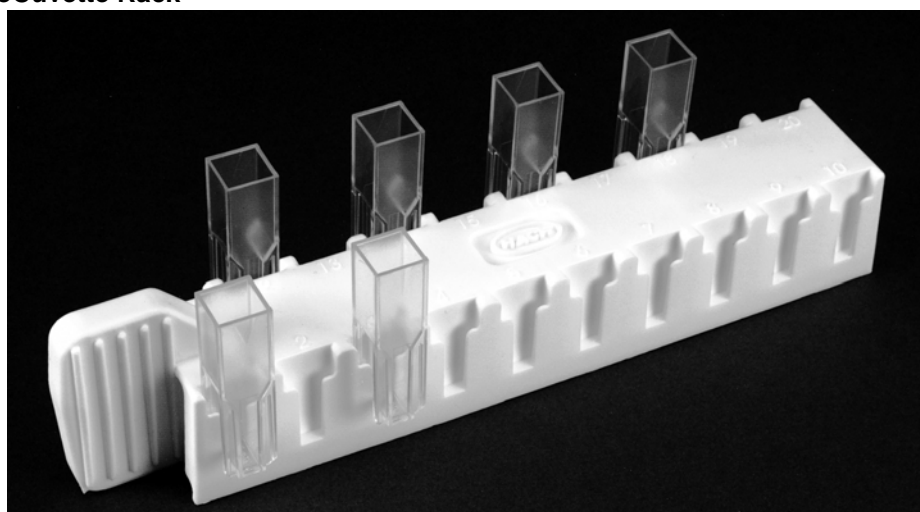

Loading the Rack—The cuvette rack is designed so that it may be inverted with the cuvettes in place. Identify each cuvette with a sample or calibrator number and insert all the cuvettes in the rack before beginning the procedure. Fit the cuvettes snugly into the rack, but do not force them or they may be difficult to remove and their contents may spill. The cuvettes should remain in place when the rack is inverted and tapped lightly.

Mixing—Set the rack on a hard, flat surface that is at least twice the length of the rack. Hold the rack by one end and vigorously slide it back and forth along its long axis for 30 seconds. The rack should move through a distance equal to its own length in each direction.

Interpreting and Reporting Results

There is an inverse relationship between the concentration of Atrazine and the reading. In other words, the higher the reading, the lower the concentration of Atrazine.

Table 1 Relative Atrazine Concentration

If the sample reading is...	the sample Atrazine Concentration is...
...less than calibrator reading	...greater than the calibrator concentration
...greater than calibrator reading	...less than the calibrator concentration

Example Readings:

0.5 ppb Atrazine Calibrator: **0.475 Abs**

3.0 ppb Atrazine Calibrator: **0.245 Abs**

Sample #1: **0.140 Abs**

Sample #2: **0.300 Abs**

Sample #3: **0.550 Abs**

Interpretation

Sample #1—Sample reading is less than the readings for both calibrators. Therefore the sample concentration of Atrazine is greater than both 0.5 ppb and 3.0 ppb Atrazine.

Sample #2—Sample reading is between the readings for the 0.5 ppb and 3.0 ppb Atrazine calibrators. Therefore the sample concentration of Atrazine is between 0.5 ppb and 3.0 ppb.

Sample #3—Sample reading is greater than the readings for both calibrators. Therefore the sample concentration of Atrazine is less than both 3.0 ppb and 0.5 ppb.

Storing and Handling Reagents

- Wear protective gloves and eyewear.
- When storing reagent sets for extended periods of time, keep them out of direct sunlight. Store reagents at a temperature of 4 °C when not in use.
- Keep the foil pouch containing the Antibody Cuvettes sealed when not in use.
- If Stop Solution comes in contact with eyes, wash thoroughly for 15 minutes with cold water and seek immediate medical help.

Sensitivity

The Atrazine immunoassay test cannot differentiate between certain triazines and metabolites, but it detects their presence to differing degrees. [Table 2](#) shows the required concentration for selected chemicals. [Table 3](#) shows compounds not detectable at 10,000 ppb.

Table 2 Required Concentrations for Selected Chemicals

Compound	Concentration to give a positive result at 3 ppb (in ppb)
Ametryne	1
Atrazine	3
Atrazine, de-ethylated	115
Atrazine, de-isopropyl	714
Cyanazine	460
Cyromazine	1200
Prometon	8
Prometryne	0.7
Propazine	2.3
Simetryne	5.4
Simazine	37
Terbutylazine	91
Terbutryne	8.3

Table 3 Compounds not detectable at 10,000 ppb

Alachlor	2, 4-D
Aldicarb	Diaminoatrazine
Carbendazim	Melamine
Carbofuran	Metaolachlor

Sample Collection and Storage

Collect samples in a clean glass bottle. Do not pre-rinse the bottle with the sample. If the sample cannot be analyzed immediately, store the sample at 4 °C. Samples may be kept for as long as 14 days. Warm the samples to room temperature before analysis.

Summary of Method

Immunoassay tests use antigen/antibody reactions to test for specific organic compounds in water and soil. Atrazine-specific antibodies, attached to the walls of plastic cuvettes, selectively bind and remove Atrazine from complex sample matrices. A prepared sample and a reagent containing enzyme-conjugate molecules (analyte molecules attached to molecules of an enzyme) are added to the Antibody Cuvettes. During incubation, enzyme-conjugate molecules and Atrazine compete for binding sites on the antibodies. Samples with higher levels of analyte will have more antibody sites occupied by Atrazine and fewer antibody sites occupied by the enzyme-conjugate molecules.

After incubation, the sample and unbound enzyme conjugate are washed from the cuvette and a color-development reagent is added. The enzyme in the conjugate catalyzes the development of color. Therefore, there is an inverse relationship between color intensity and the amount of Atrazine in the sample. The resulting color is then compared with a calibrator to determine whether the Atrazine concentration in the sample is greater or less than the threshold levels. Test results are measured at 450 nm.

Consumables and Replacement Items

Required Reagents

Description	Unit	Cat. No.
Atrazine Reagent Set ¹	20 cuvettes	27627-00

¹ Immunoassay components are manufactured by Beacon Analytical Systems, Inc.

Required Apparatus

Description	Unit	Cat. No.
Adapter, 1-cm square cell	each	
Caps, flip spout	2/pkg	25818-02
Marker, laboratory	each	20920-00
Pipet, TenSette®, 0.1–1.0 mL	each	19700-01
Pipet Tips, for TenSette Pipet 19700-01	1000/pkg	21856-28
Rack, for 1-cm Micro Cuvettes	each	48799-00
Wipes, disposable	box	20970-00

Optional Reagents and Apparatus

Description	Unit	Cat. No.
Atrazine Reagent Set	100 cuvettes	27627-10
Glasses, safety	each	27568-00
Gloves, disposable, nitrile, medium ¹	—	25505-02
Pipet Tips, for TenSette Pipet 19700-01	50/pkg	21856-96

¹ Other sizes are available.



FOR TECHNICAL ASSISTANCE, PRICE INFORMATION AND ORDERING:

In the U.S.A. – Call toll-free 800-227-4224
Outside the U.S.A. – Contact the HACH office or distributor serving you.
On the Worldwide Web – www.hach.com; E-mail – techhelp@hach.com

HACH COMPANY
WORLD HEADQUARTERS
Telephone: (970) 669-3050
FAX: (970) 669-2932

★Method 8014

Turbidimetric Method¹

Powder Pillows

(2 to 100 mg/L)

Scope and Application: For water, wastewater, oil-field water, and seawater

¹ Adapted from Snell and Snell, *Colorimetric Methods of Analysis, Vol. II*, 769 (1959).



Test Preparation

Before starting the test:

Perform a standard curve adjustment or a new calibration for each new lot of reagent. See [Standard Solutions on page 2](#) and [Calibration Standard Preparation on page 3](#).

For more accurate results, determine a reagent blank value for each new lot of reagent. Follow the procedure using deionized water in place of the sample. Subtract the reagent blank value from the final results or perform a reagent blank adjust.

Filter highly colored or turbid water samples using a funnel¹ and filter paper¹. Large amounts of color or turbidity will interfere and cause high readings.

Immediately after each test, clean the sample cell with soap, water, and a brush to prevent a film from forming inside the sample cell.

Collect the following items:

Quantity

BariVer® 4 Barium Reagent Powder Pillows

1

Sample cells, 1-inch square, 10-mL

2

Note: Reorder information for consumables and replacement items is on page 4.

¹ See [Optional Reagents and Apparatus on page 4](#).

Powder Pillows

Method 8014



1. Press **STORED PROGRAMS**.

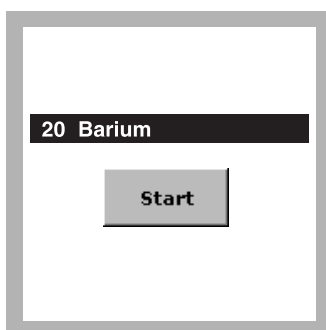

2. Select the test.

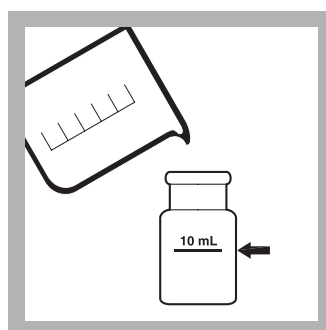

3. Fill a square sample cell with 10 mL of sample.

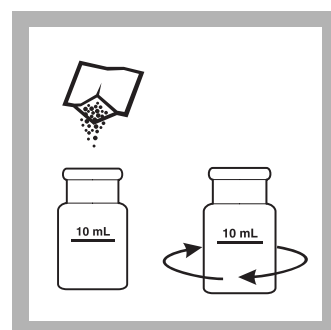

4. **Prepared Sample:** Add the contents of one BariVer® 4 Barium Reagent Powder Pillow to the cell.

If barium is present, a white turbidity will develop.

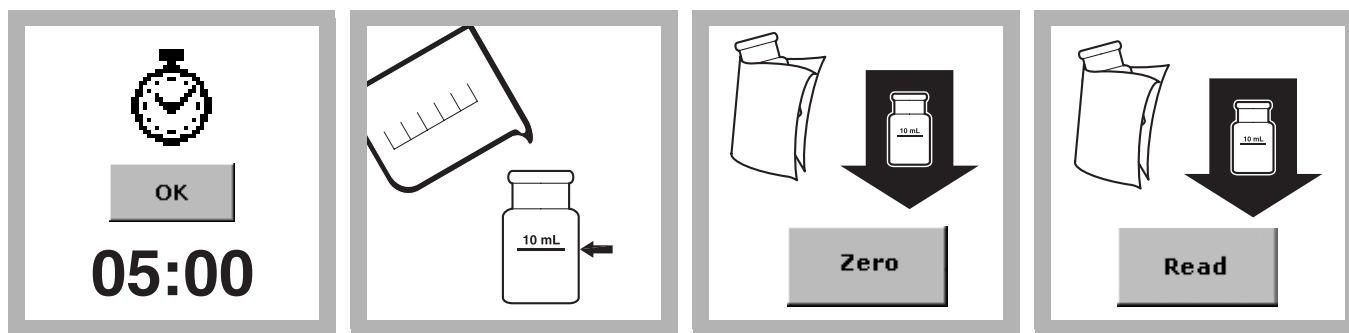

5. Press TIMER>OK.

A five-minute reaction period will begin.

Do not disturb the sample during the reaction period.

6. Blank Preparation:

Fill another square sample cell with 10 mL of sample.

7. When the timer expires, wipe the blank and insert the blank into the cell holder with the fill line facing right.

Press **ZERO**. The display will show:

0.0 mg/L Ba²⁺

8. Wipe and the prepared sample and insert the prepared sample into the cell holder with the fill line facing right.

Press **READ**. Results are in mg/L Ba²⁺.

Interferences

Table 1 Interfering Substances and Levels

Interfering Substance	Interference Levels and Treatments
Calcium	10,000 mg/L as CaCO ₃
Magnesium	100,000 mg/L as CaCO ₃
Silica	500 mg/L
Sodium Chloride	130,000 mg/L as NaCl
Strontium	Interferes at any level. If present, the total concentration between barium and strontium may be expressed as a PS (Precipitated by Sulfate). While this does not distinguish between barium and strontium, it gives an accurate indication of scaling tendency.
Highly buffered samples or extreme sample pH	May exceed the buffering capacity of the reagents and require sample pretreatment.

Sample Collection, Preservation, and Storage

Collect samples in an acid cleaned glass or plastic container. Adjust the pH to 2 or less with nitric acid* (about 2 mL per liter). Preserved samples can be stored up to six months at room temperature. Before analysis, adjust the pH to 5 with 5.0 N sodium hydroxide*. Correct the test result for volume additions.

Standard Solutions

Prepare a 90.0-mg/L barium standard solution as follows:

1. Pipet 9.00 mL of Barium Standard Solution, 1000-mg/L, into a 100-mL volumetric flask.
2. Dilute to the mark with deionized water.
3. Prepare this solution daily. Perform the barium procedure as described above.

*See [Optional Reagents and Apparatus on page 4](#).

To adjust the calibration curve using the reading obtained with the 90.0-mg/L standard solution:

1. Touch **OPTIONS>MORE** on the current program menu. Touch **STANDARD ADJUST** on the Options menu.
2. Touch **ON**. Touch **ADJUST** to accept the displayed concentration. If an alternate concentration is used, touch the number in the box to enter the actual concentration, then touch **OK**. Touch **ADJUST**.

Accuracy Check

Standard Additions Method (Sample Spike)

1. After reading test results, leave the sample cell, or AccuVac Ampul (unspiked sample) in the instrument. Verify the chemical form.
2. Press **OPTIONS>MORE**. Press **STANDARD ADDITIONS**. A summary of the standard additions procedure will appear.
3. Press **OK** to accept the default values for standard concentration, sample volume, and spike volumes. Press **EDIT** to change these values. After values are accepted, the unspiked sample reading will appear in the top row. See the user manual for more information.
4. Open a Barium Standard Solution, 1000-mg/L Ba.
5. Prepare a 0.1 mL sample spike by adding 0.1 mL of standard to the unspiked sample. Touch the timer icon. After the timer expires, read the result. Press **READ** to accept the reading.
6. Prepare a 0.2 mL sample spike by adding 0.1 mL of standard to the 0.1 mL sample spike. Touch the timer icon. After the timer expires, read the result. Press **READ** to accept the reading.
7. Prepare a 0.3 mL sample spike by adding 0.1 mL of standard to the 0.2 mL sample spike. Touch the timer icon. After the timer expires, read the result. Press **READ** to accept the reading.
8. Each addition should reflect approximately 100% recovery.
9. After completing the sequence, press **GRAPH** to view the best-fit line through the standard additions data points, accounting for the matrix interferences. Press **IDEAL LINE** to view the relationship between the sample spikes and the "Ideal Line" of 100% recovery.

Calibration Standard Preparation

Prepare calibration standard containing 10, 20, 30, 50, 80, 90, and 100 mg/L Ba as follows:

1. Into seven different 100-mL Class A volumetric flasks, pipet 1, 2, 3, 5, 8, 9, and 10 mL of the 1000-mg/L Barium Standard Solution using Class A glassware.
2. Dilute to the mark with deionized water. Mix thoroughly.
3. Using the turbidimetric method and the calibration procedure described in the user manual, generate a calibration curve from the standards prepared above.

Summary of Method

The BariVer® 4 Barium Reagent Powder combines with barium to form a barium sulfate precipitate, which is held in suspension by a protective colloid. The amount of turbidity present caused by the fine white dispersion of particles is directly proportional to the amount of barium present. Test results are measured at 450 nm.

Consumables and Replacement Items

Required Reagents

Description	Quantity/Test	Unit	Cat. No.
BariVer® 4 Barium Reagent Powder Pillows	1	100/pkg	12064-99

Required Apparatus

Description	Quantity/Test	Unit	Cat. No.
Beaker, 50-mL	1	each	500-41H
Sample Cells, 1-inch square, 10 mL, matched pair	2	2/pkg	24954-02

Recommended Standards

Description	Unit	Cat. No.
Barium Standard Solution, 1000-mg/L Ba	100 mL	14611-42
Water, deionized	4 L	272-56

Optional Reagents and Apparatus

Description	Unit	Cat. No.
Filter paper for funnel 12, 0.5 cm	100/pkg	1894-57
Funnel, 65 mm	each	1083-67
Nitric Acid 1:1, 500 mL	—	2540-49
Sodium Hydroxide, 5.0 N, 100 mL	—	2450-32



FOR TECHNICAL ASSISTANCE, PRICE INFORMATION AND ORDERING:
In the U.S.A. – Call toll-free 800-227-4224
Outside the U.S.A. – Contact the HACH office or distributor serving you.
On the Worldwide Web – www.hach.com; E-mail – techhelp@hach.com

HACH COMPANY
WORLD HEADQUARTERS
Telephone: (970) 669-3050
FAX: (970) 669-2932

Benzotriazole/Tolyltriazole

Method 8079

UV Photolysis Method¹

Powder Pillows

(Benzotriazole 1.0 to 16.0 mg/L,
Tolyltriazole 1.0 to 20.0 mg/L)

Scope and Application: For cooling or boiler water

¹ Adapted from Harp, D., *Proceedings 45th International Water Conference*, 299 (October 22–24, 1984)



Test Preparation

Before starting the test:

Avoid fingerprints on the quartz surface of the lamp. Rinse the lamp and wipe with a soft, clean tissue between tests.

Check the sample temperature. It must be between 20–25 °C (68 –78 °F) for accurate results.

If sample contains nitrite or borax (sodium borate), adjust the pH to 4–6 with 1 N sulfuric acid.

If the sample contains more than 500 mg/L hardness (as CaCO₃), add 10 drops of Rochelle Salt Solution before adding reagent.

Collect the following items:

Quantity

Triazole Reagent powder pillows	1
One-inch square 10-mL sample cells	2
Square bottle, 25-mL	1
Ultra-violet lamp with power supply	1
UV safety goggles	1

Note: Reorder information for consumables and replacement items is on page 5.

Powder Pillows

Method 8079

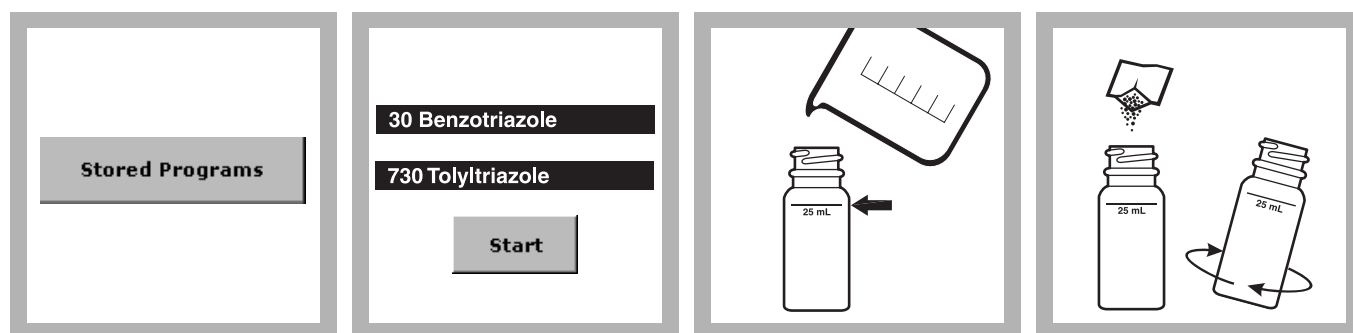

1. Press
STORED PROGRAMS.

2. Select the test.

3. **Prepared Sample:**
Fill a marked mixing bottle
to the 25 mL line with
sample.

4. Add the contents of
one Triazole Reagent
Powder Pillow.
Swirl to dissolve
completely.

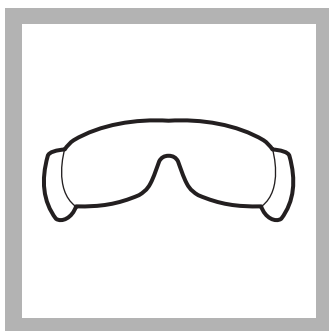

5. Put on UV safety goggles.

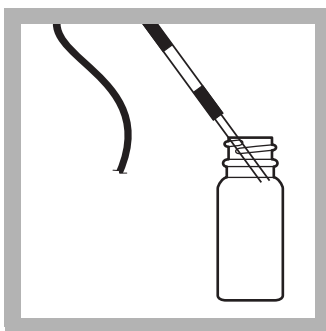

6. Insert the ultraviolet lamp into the mixing bottle. Turn on the UV lamp.

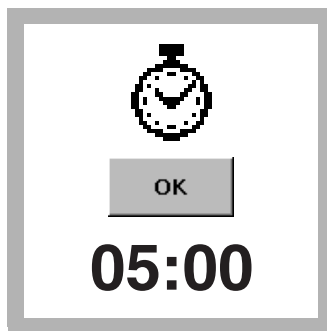

7. Press **TIMER>OK**.
A 5-minute reaction period will begin. Low results will occur if photolysis (lamp on) takes place for more or less than five minutes.
A yellow color will form if triazole is present.



8. When the timer expires, turn the lamp off. Remove the lamp from the bottle. Swirl the bottle to mix thoroughly.

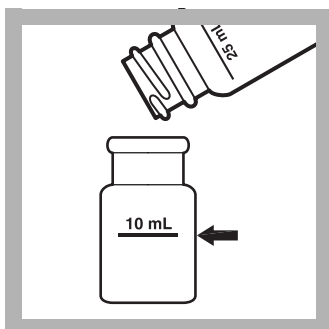

9. Fill a square sample cell with 10 mL of reacted (prepared) sample.

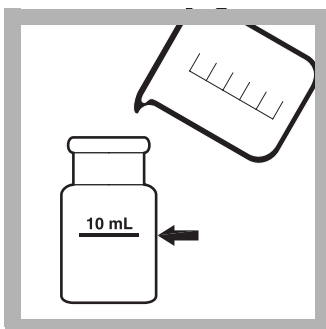

10. Blank Preparation: Fill another square sample cell with 10 mL of sample.

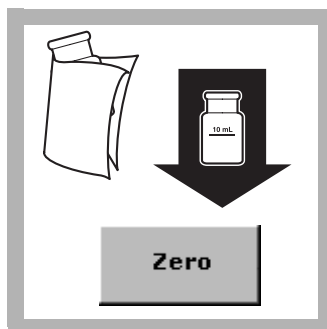

11. Insert the blank into the cell holder with the fill line facing right.
Press **ZERO**.
The display will show:
0.0 mg/L Benzotriazol
or
0.0 mg/L Tolyltriazol



12. Insert the prepared sample into the cell holder with the fill line facing right.
Press **READ**. Results are in mg/L Benzotriazol or mg/L Tolyltriazol.

Interferences

Table 1 Interfering Substances and Levels

Interfering Substance	Interference Levels and Treatments
Acrylates (as methyl acrylate)	Greater than 50 mg/L
Alum	Greater than 400 mg/L
Borate (as sodium tetraborate)	Greater than 4000 mg/L. Adjust the pH to 4–6 with 1 N sulfuric acid ¹ .
Chlorine (as Cl ₂)	Greater than 20 mg/L
Chromium (as chromate)	Greater than 12 mg/L
Copper	Greater than 10 mg/L
Hardness	Greater than 500 mg/L as CaCO ₃ . Add 10 drops of Rochelle Salt Solution ¹ before adding reagent.
Iron	Greater than 20 mg/L
Lignosulfonates	Greater than 40 mg/L
Magnesium	Greater than 300 mg/L as CaCO ₃
Molybdenum (as molybdate)	Greater than 200 mg/L
Nitrite	Greater than 4000 mg/L. Adjust the pH to 4–6 with 1 N sulfuric acid ¹ .
Phosphonates (AMP or HEDP)	Greater than 100 mg/L
Sulfate	Greater than 200 mg/L
Zinc	Greater than 80 mg/L
Strong oxidizing or reducing agents	Interfere at all levels

¹ See [Optional Reagents on page 5](#).

Sample Collection, Storage, and Preservation

The most reliable results are obtained when samples are analyzed as soon as possible after collection.

Accuracy Check

Standard Additions Method (Sample Spike)

1. After reading test results, leave the sample cell (unspiked sample) in the instrument.
2. Press **OPTIONS>MORE**. Press **STANDARD ADDITIONS**. A summary of the standard additions procedure will appear.
3. Press **OK** to accept the default values for standard concentration, sample volume, and spike volumes. Press **EDIT** to change these values. After values are accepted, the unspiked sample reading will appear in the top row. See the user manual for more information.
4. Open a 500-mg/L Benzotriazole Standard Solution*.

* See [Optional Reagents on page 5](#).

5. Prepare three sample spikes. Fill three mixing cylinders with 25 mL of sample. Use the TenSette Pipet to add 0.1 mL, 0.2 mL, and 0.3 mL of standard, respectively, to each sample and mix thoroughly.
6. Analyze each sample spike as described in the procedure above, starting with the 0.1 mL sample spike. Accept each standard additions reading by pressing **READ**. Each addition should reflect approximately 100% recovery.
7. After completing the sequence, press **GRAPH** to view the best-fit line through the standard additions data points, accounting for matrix interferences. Press **IDEAL LINE** to view relationships between the sample spikes and the "Ideal Line" of 100% recovery.

UV Lamp Check

To verify the ultraviolet lamp (normal life equals 5000 hours) is working properly, perform the following test:

1. Prepare a 5.0 mg/L benzotriazole standard solution by pipetting 10.0 mL of Benzotriazole Standard Solution, 500-mg/L benzotriazole, into a 1-liter volumetric flask. Dilute to volume.
2. Analyze according to the above procedure. If the result is significantly below 5 mg/L, replace the lamp.

Summary of Method

Benzotriazole or tolyltriazole, used in many applications as corrosion inhibitors for copper and copper alloys, are determined by a proprietary catalytic ultraviolet (UV) photolysis procedure requiring less than 10 minutes to perform. Test results are measured at 425 nm.

Consumables and Replacement Items

Required Reagents

Description	Quantity/Test	Unit	Cat. No.
Triazole Reagent Powder Pillows	1	100/pkg	21412-99

Required Apparatus

Description	Quantity/Test	Unit	Cat. No.
UV Safety Goggles	1	each	21134-00
Sample Cell, 1-in. Square, 10 mL	2	2/pkg	24954-02
Bottle, Square, with 25 mL mark	1	each	17042-00
Select one based on available voltage:			
Lamp Kit, UV, with power supply, 115 VAC, 60 Hz	1	each	20828-00
Lamp Kit, UV, with power supply, 230 VAC, 50 Hz	1	each	20828-02

Recommended Standards

Description	Quantity/Test	Unit	Cat. No.
Benzotriazole Standard Solution, 500-mg/L	0.6 mL	100 mL	21413-42

Optional Reagents

Description	Cat. No.
Sulfuric Acid, 1 N	1270-32
Rochelle Salt Solution	1725-33



FOR TECHNICAL ASSISTANCE, PRICE INFORMATION AND ORDERING:

In the U.S.A. – Call toll-free 800-227-4224

Outside the U.S.A. – Contact the HACH office or distributor serving you.

On the Worldwide Web – www.hach.com; E-mail – techhelp@hach.com

HACH COMPANY
WORLD HEADQUARTERS
Telephone: (970) 669-3050
FAX: (970) 669-2932

Method 10061

Powder Pillows

Azomethine-H Method¹

LR (0.02 to 1.50 mg/L as B)

Scope and Application: For testing low levels of boron (boric acid or borates) in drinking water, cooling water, industrial process waters, or wastewaters

¹ Adapted from ISO Method 9390 Harp, D.L., Analytica Chimica Acta, 346(1997), pp. 373–379.



Test Preparation

Before starting the test:

For best results, match two cells using the [Cell Matching Procedure on page 3](#).

Sample temperature should be 22–24 °C (72–75 °F) for most accurate results.

If outside this range, measure and record the sample temperature. See .

In bright light conditions (e.g. direct sunlight) it may be necessary to close the cell compartment with the protective cover during measurements.

Collect the following items:

Quantity

BoroTrace™ Reagent Set Includes:	—
EDTA Solution, 1M	20 drops
BoroTrace™ #2 Reagent Powder Pillow	2
BoroTrace™ #3 Reagent Powder Pillow	2
Water, Ultra-pure, aldehyde-free	25 mL
Sample cell, 1-inch square, plastic, with cap	2

Note: Reorder information for consumables and replacement items is on page 6.

Powder Pillows

Method 10061



1. Press **STORED PROGRAMS**.

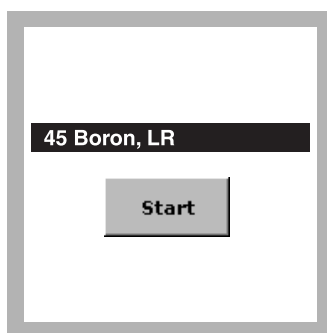

2. Select the test.



3. **Blank Preparation:**
Fill a clean plastic sample cell to the 25-mL mark with ultra-pure water.

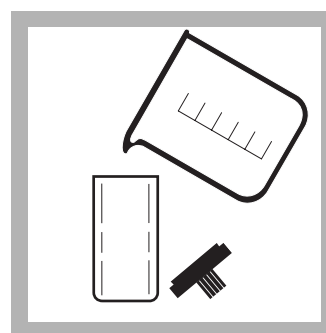

4. **Prepared Sample:**
Fill a second clean plastic sample cell to the 25-mL mark with sample.

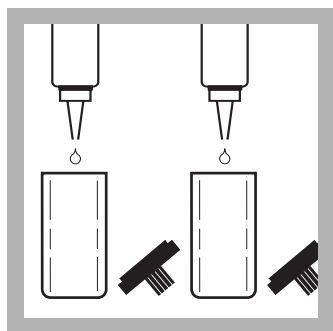

5. Add ten drops of EDTA Solution, 1 M, to each cell. Cap and invert each cell twice to mix.

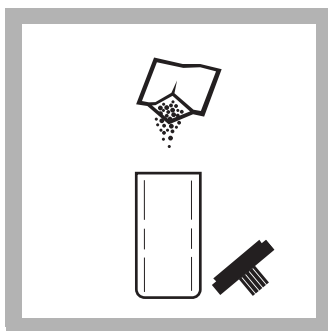

6. Open one pillow BoroTrace™ 2 Reagent and add the contents to the prepared sample.

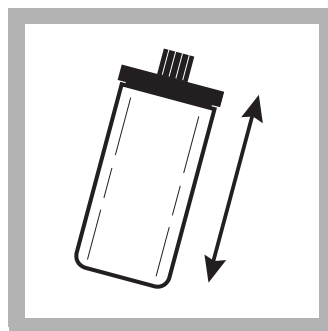

7. Cap the prepared sample and shake to dissolve the powder. Proceed immediately with steps 8 and 9.

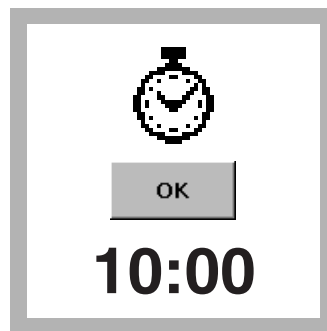

8. Press **TIMER>OK**. A ten-minute reaction period will begin.

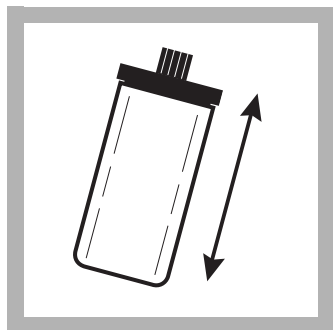

9. Continue shaking vigorously for 30 seconds, or until all powder is dissolved

Let the cell sit capped for the remaining reaction period.

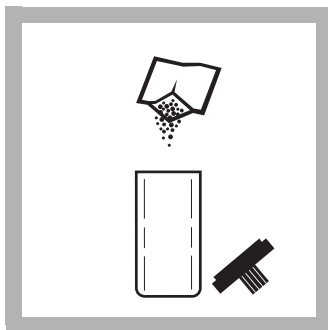

10. During the reaction period, add the contents of a BoroTrace™ 2 Reagent Powder Pillow to the blank.

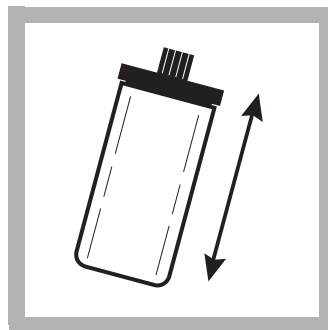

11. Cap the blank and shake vigorously until the powder is dissolved.

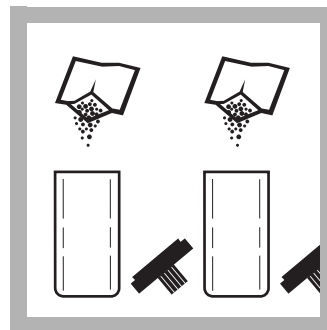

12. After the timer expires, add the contents of one BoroTrace™ 3 Reagent Powder Pillow to each cell. Cap and shake to dissolve.

BoroTrace™ 3 Reagent “stops” the reaction.



13. Wipe the blank and insert it into the cell holder.

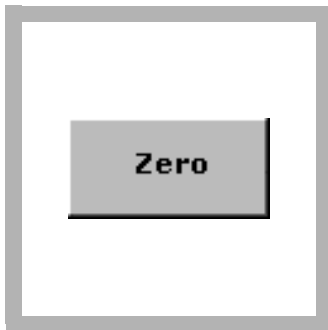

14. Press **ZERO**. The display will show:
0.00 mg/L B

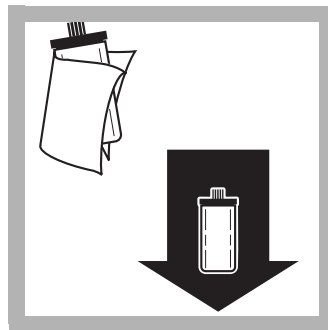

15. Wipe the prepared sample and insert it into the cell holder.

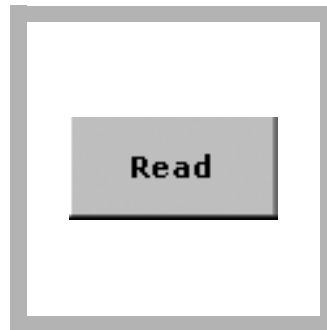

16. Press **READ**. Results are in mg/L B.

Cell Matching Procedure

1. Rinse and fill two cells with deionized water.
2. Wipe each cell with a soft cloth or tissue to remove liquid or fingerprints.
3. Using one of the cells, set the instrument absorbance at 410 nm to zero.
4. Read the absorbance of the other cell.
5. Cells that read within 0.002 absorbance are matched.

Interferences

The substances in [Table 1](#) have been tested for interference and found not to interfere up to the indicated levels (in mg/L):

Table 1 Interfering Substances and Levels

Substance	Interference Level Tested
Aluminum (3+)	10
Benzotriazole	20
Biocides:	
Carbamate-type	120
Isothiazolin-type	120
Quat-type	90
Thiocyanate-type	60
Calcium	1000 (as CaCO ₃)
Chloride	2500
Copper (2+)	20
Magnesium	1000 (as CaCO ₃)
Manganese (7+)	5
Molybdate (Mo ⁶⁺)	60
Phosphonates, AMP	20
Phosphonates, HEDP	20
Polyacrylates	20 (as Acumer 1000, 1100)
Polymaleic Acid	40 (as Belclene 200)
Silica	120
Sulfate	1800
Sulfite	40
Tolyltriazole	20
Zinc (2+)	10

Table 2 lists suggested treatments for interferences:

Table 2 Interfering Substances and Suggested Treatments

Interfering Substance	Interference Levels and Treatments
Alkalinity >500 mg/L (+ or -)	<ol style="list-style-type: none"> Adjust sample pH to between 5–7 using 1.0 N Sulfuric Acid Solution¹. Continue with step 5 of the analytic procedure.
Color (+)	<ol style="list-style-type: none"> Zero the instrument (0.00 mg/L B) using Ultra-Pure Water². Measure and record the apparent concentration, in mg/L B, due to the sample color. Subtract the apparent concentration from the result in step 16 of the test procedure.
Halogens (Bromine or Chlorine) all levels (+)	<p>Halogen disinfectants in the sample can produce a red-color after the addition of BoroTrace™ 2 Reagent. To eliminate this interference:</p> <ol style="list-style-type: none"> Add 1 pillow Dechlorinating Reagent¹ to 25 mL each of Ultra-Pure Water² and sample. Cap and shake to dissolve. Continue with step 5 of the test procedure.
Iron (Fe ³⁺ or Fe ²⁺), above 8 mg/L (+)	<p>High levels of iron in the sample can produce a red-color after the addition of BoroTrace™ 2 Reagent. To compensate, increase the amount of EDTA² from 10 drops to 15 drops to be added to each cell (step 6). Alternatively, dilute the sample with Ultra-Pure Water and continue with step 5 of the test procedure. Correct the results (step 16) using the appropriate dilution factor.</p>
Nitrites, all levels (+)	<ol style="list-style-type: none"> Add 0.1 gram scoop Sulfamic Acid¹ to 25 mL each Ultra-Pure Water and sample in plastic cells. Cap and shake to dissolve. Uncap and wait 5 minutes. Add 5 N Sodium Hydroxide Reagent¹ solution to each to adjust pH to 5–8 using pH paper. Continue with step 4 of the test procedure.
Turbidity (+)	Filter the sample through a 3 µm membrane ¹ prior to testing. Do not use a glass fiber filter.

¹ Optional Reagents and Apparatus on page 6

² Required Reagents on page 6

Sample Collection, Preservation, and Storage

Collect samples in clean polyethylene bottles. Do not use borate-based detergents or soaps to clean sample containers or labware used for this method. After use, thoroughly rinse all plastic containers with deionized water, allow to air dry, and keep covered.

Sample Temperature Compensation

The reaction chemistry is very dependent on the sample temperature. Calibrations are performed at 23 °C (73 °F). If the sample temperature is outside the range of 22–24 °C (72–75 °F), multiply the results, in mg/L, by the appropriate multiplier (Table 3).

Table 3 Sample Temperature Multipliers

Sample Temp.		Multiplier	Sample Temp.		Multiplier
°C	°F		°C	°F	
5	41	0.70	20	68	0.94
7	45	0.73	25	77	1.04
10	10	0.78	26	79	1.06

Table 3 Sample Temperature Multipliers (continued)

Sample Temp.		Multiplier	Sample Temp.		Multiplier
°C	°F		°C	°F	
12	54	0.81	27	81	1.08
14	57	0.84	28	82	1.10
16	61	0.87	29	84	1.12
18	64	0.91	30	86	1.15

Accuracy Check

Standard Additions Method (Sample Spike)

1. After reading test results, leave the sample cell (unspiked sample) in the instrument. Verify the chemical form.
2. Press **OPTIONS>MORE**. Press **STANDARD ADDITIONS**. A summary of the standard additions procedure will appear.
3. Press **OK** to accept the default values for standard concentration, sample volume, and spike volumes. Press **EDIT** to change these values. After values are accepted, the unspiked sample reading will appear in the top row. See the user manual for more information.
4. Prepare a 50.0-mg/L boron standard by pipetting 5.0 mL of a 1000-mg/L Boron Standard Solution into a 100-mL plastic volumetric flask. Dilute with deionized water, stopper and invert to mix.
5. Prepare three sample spikes. Fill three mixing cylinders* with 25 mL of sample. Use the TenSette® Pipet to add 0.1 mL, 0.2 mL, and 0.3 mL of the diluted standard, respectively, to each sample and mix thoroughly.
6. Analyze each sample spike as described in the procedure above, starting with the 0.1 mL sample spike. Accept each standard additions reading by pressing **READ**. Each addition should reflect approximately 100% recovery.
7. After completing the sequence, press **GRAPH** to view the best-fit line through the standard additions data points, accounting for the matrix interferences. Press **IDEAL LINE** to view the relationship between the sample spikes and the "Ideal Line" of 100% recovery.

Standard Solution Method

Prepare a 1.0-mg/L B standard as follows:

1. Using plastic pipet, transfer 4.0 mL of Boron Standard Solution, 250-mg/L as B, into a 1000-mL plastic volumetric flask. Dilute to volume with deionized water, stopper and invert to mix.
2. To adjust the calibration curve using the reading obtained with the standard solution, press **OPTIONS>MORE** on the current program menu. Press **STANDARD ADJUST**.
3. Press **ON**. Press **ADJUST** to accept the displayed concentration. If an alternate concentration is used, press the number in the box to enter the actual concentration, then press **OK**. Press **ADJUST**.

* Optional Reagents and Apparatus on page 6

Summary of Method

Azomethine-H, a Schiff base, is formed by the condensation of an aminonaphthol with an aldehyde by the catalytic action of boron. Test results are measured at 410 nm.

Consumables and Replacement Items

Required Reagents

Description	Quantity/Test	Unit	Cat. No.
BoroTrace™ Reagent Set, includes:	—	—	26669-00
EDTA Solution, 1 M	20 drops	50 mL SCDB	22419-26
BoroTrace™ #2 Reagent Powder Pillows	2	100/pkg	26666-69
BoroTrace™ #3 Reagent Powder Pillows	2	100/pkg	26667-99
Water, Ultra-pure, Aldehyde-free	25-mL	500 mL	25946-49

Required Apparatus

Description	Quantity/Test	Unit	Cat. No.
Sample cell, 1-inch square plastic, with cap	2	12/pkg	24102-12

Recommended Standards

Description	Unit	Cat. No.
Boron Standard Solution, 10-mL Voluette® Ampule, 250 mg/L B	16/pkg	14249-10
Boron Standard Solution, 1000-mg/L as B	100 mL	1914-42

Optional Reagents and Apparatus

Description	Unit	Cat. No.
Cylinder, mixing, 25 mL	each	20886-40
Dechlorinating Reagent, Powder Pillows	100/pkg	14363-69
Filter Holder, 25 mm	each	2468-00
Membrane, filter, 3 µm, 25 mm	25/pkg	25940-25
pH Paper, 1.0–11.0	5 rolls/pkg	391-33
Pipet, TenSette®, 0.1–1.0 mL	each	19700-01
Pipet, tips for 19700-01 TenSette Pipet	50/pkg	21856-96
Pipet, volumetric, 5.00 mL	each	14515-37
Safety Bulb	each	14651-00
Sodium Hydroxide Reagent, 5.0 N, 50 mL	each	2450-26
Spoon, measuring, 0.1 g	each	511-00
Sulfamic Acid, 113g	each	2344-14
Sulfuric Acid Solution 1.0N, 100 mL	each	1270-32
Syringe, 30 cc Luer-lock	each	22258-00



FOR TECHNICAL ASSISTANCE, PRICE INFORMATION AND ORDERING:
In the U.S.A. – Call toll-free 800-227-4224
Outside the U.S.A. – Contact the HACH office or distributor serving you.
On the Worldwide Web – www.hach.com; E-mail – techhelp@hach.com

HACH COMPANY
WORLD HEADQUARTERS
Telephone: (970) 669-3050
FAX: (970) 669-2932

Method 8015

Carmines Method¹

Powder Pillows

(0.2 to 14.0 mg/L)

Scope and Application: For water and wastewater

¹ Adapted from *Standard Methods for the Examination of Water and Wastewater*.



Test Preparation

Before starting the test:

All labware must be completely dry. Excess water will cause low results.

Use the BoroVer[®] 3 Reagent with adequate ventilation. See [Reagent Preparation on page 3](#).

Do not cap the sample cells or the Erlenmeyer flasks at any time during sample preparation or reaction time. Samples may be capped immediately prior to placing in the instrument.

Sulfuric acid may contain residual moisture; this will cause low results.

Ensure sulfuric acid suitability by running a known boron standard before running any unknown samples.

Collect the following items:

Quantity

BoroVer 3 Reagent Powder Pillow	1
Cylinders, graduated, 50-mL and 100 mL	1 of each
Flask, Erlenmeyer, 125-mL	2
Flask, Erlenmeyer, 250-mL	1
Pipet, volumetric, 2.0 mL	2
Sulfuric Acid, Concentrated	75 mL
Sample Cells, 1-inch square	2
Water, deionized	2.0 mL

Note: Reorder information for consumables and replacement items is on [page 5](#).



1. Press **STORED PROGRAMS**.

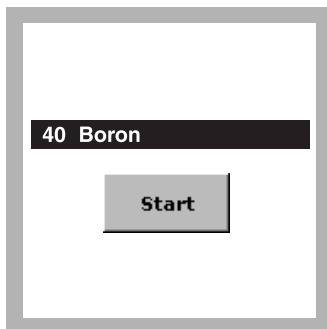

2. Select the test.

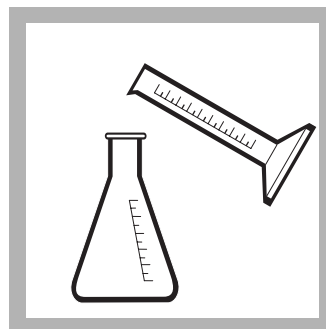

3. Using a 100-mL graduated cylinder, measure 75 mL of concentrated sulfuric acid. Pour the acid into a 250-mL Erlenmeyer flask.

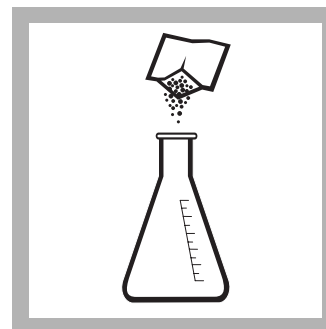

4. Add the contents of one BoroVer 3 Reagent Powder Pillow to the flask. Swirl to mix. Allow up to five minutes for the powder to dissolve completely.

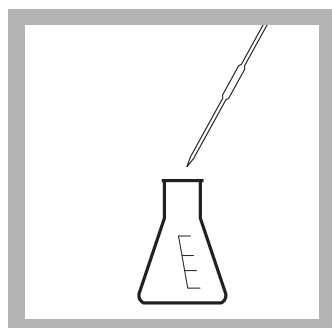

5. **Blank Preparation:** Accurately pipet 2.0 mL of deionized water into a 125-mL Erlenmeyer flask.

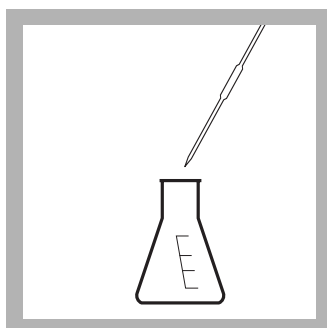

6. **Prepared Sample:** Accurately pipet 2.0 mL of sample into another 125-mL Erlenmeyer flask.



7. Using a 50-mL graduated cylinder, add 35 mL of the solution prepared in step 4 to each Erlenmeyer flask. Swirl to mix completely.

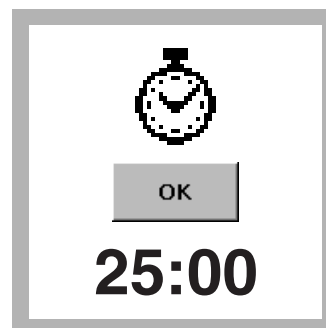

8. Press **TIMER>OK**. A 25-minute reaction period will begin.

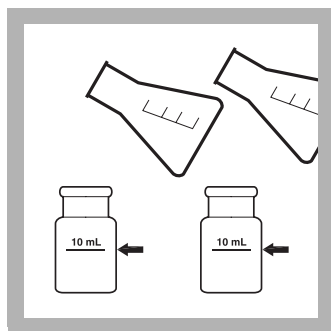

9. When the timer expires, pour at least 10 mL from each flask into separate square sample cells.



10. Wipe the blank and insert the blank into the cell holder with the fill line facing right.

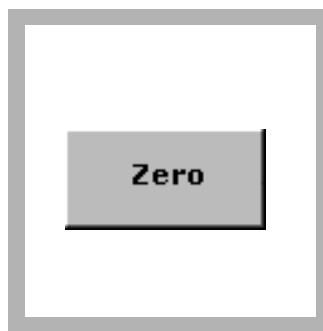

11. Press **ZERO**.
The display will show:
0.0 mg/L B



12. Wipe the prepared sample and insert the prepared sample into the cell holder with the fill line facing right.

Press **READ**. Results are in mg/L B.

Sample Collection, Preservation, and Storage

Collect samples in clean polyethylene or polypropylene bottles, or alkali-resistant, boron-free glass.

Reagent Preparation

To prepare additional BoroVer 3/Sulfuric Acid Solution, mix one BoroVer 3 Reagent Powder Pillow per 75 mL of concentrated sulfuric acid, adding the powder pillows individually while stirring. Preparation of this solution generates gaseous HCl when the indicator pillow is added to the sulfuric acid. Use of a fume hood or other well-ventilated lab area is strongly advised. This solution is stable for up to 48 hours if stored in plastic containers. Do not store in borosilicate glassware (Pyrex® or Kimax®) for longer than one hour; the solution may leach boron from these containers.

The BoroVer 3/Sulfuric Acid Solution is highly acidic. Neutralize to pH 6–9 and flush down the drain for disposal. Refer to the current MSDS for safe handling and disposal instructions.

Accuracy Check

Standard Additions Method (Sample Spike)

1. After reading test results, leave the unspiked sample in the instrument. Verify the chemical form.
2. Press **OPTIONS>MORE**. Press **STANDARD ADDITIONS**. A summary of the standard additions procedure will appear.
3. Press **OK** to accept the default values for standard concentration, sample volume, and spike volumes. Press **EDIT** to change these values. After values are accepted, the unspiked sample reading will appear in the top row. See the user manual for more information.
4. Snap the neck off a Boron Voluette® Ampule Standard, 250-mg/L B.

5. Prepare three sample spikes. Fill three mixing cylinders* with 25 mL of sample. Use the TenSette® Pipet to add 0.1 mL, 0.2 mL, and 0.3 mL of standard, respectively, to each sample and mix thoroughly.
6. Analyze 2.0 mL of each sample spike as described in the procedure above, starting with the 0.1 mL sample spike. Accept each standard additions reading by pressing **READ**. Each addition should reflect approximately 100% recovery.
7. After completing the sequence, press **GRAPH** to view the best-fit line through the standard additions data points, accounting for the matrix interferences. Press **IDEAL LINE** to view the relationship between the sample spikes and the "Ideal Line" of 100% recovery.

Standard Solution Method

Check the accuracy of the test using Boron Standard Solution, 10-mg/L as B. Prepare this solution as follows:

1. Using Class A glassware, pipet 10.00 mL of the Boron Voluette Ampule Standard, 250-mg/L B, into a 250-mL volumetric flask. Dilute to volume with deionized water. Swirl to mix.
2. To adjust the calibration curve using the reading obtained with the standard solution, press **OPTIONS>MORE** on the current program menu. Press **STANDARD ADJUST**.
3. Press **ON**. Press **ADJUST** to accept the displayed concentration. If an alternate concentration is used, press the number in the box to enter the actual concentration, then press **OK**. Press **ADJUST**.

Summary of Method

Boron is determined by its reaction with carminic acid in the presence of sulfuric acid to produce a reddish to bluish color. The amount of color is directly proportional to the boron concentration. Test results are measured at 605 nm.

* See [Optional Reagents and Apparatus on page 5](#).

Consumables and Replacement Items

Required Reagents

Description	Quantity/Test	Unit	Cat. No.
BoroVer® 3 Boron Reagent Powder Pillows	1	100/pkg	14170-99
Sulfuric Acid, ACS, concentrated	75 mL	2.5 L	979-09
Water, deionized	2.0 mL	4 L	272-56

Required Apparatus

Description	Quantity/Test	Unit	Cat. No.
Cylinder, graduated, 50-mL	1	each	508-41
Cylinder, graduated, 100-mL	1	each	508-42
Flask, Erlenmeyer, 125-mL	2	each	505-43
Flask, Erlenmeyer, 250-mL	1	each	505-46
Pipet, volumetric, 2.0-mL	2	each	14515-36
Sample cells, 10-mL, 1-inch square, matched pair	2	2/pkg	24954-02

Recommended Standards

Description	Unit	Cat. No.
Boron Standard Solution, 10-mL Voluette® Ampule, 250 mg/L B	16/pkg	14249-10

Optional Reagents and Apparatus

Description	Cat. No.
Cylinder, mixing, 25 mL	20886-40



FOR TECHNICAL ASSISTANCE, PRICE INFORMATION AND ORDERING:

In the U.S.A. – Call toll-free 800-227-4224
Outside the U.S.A. – Contact the HACH office or distributor serving you.
On the Worldwide Web – www.hach.com; E-mail – techhelp@hach.com

HACH COMPANY
WORLD HEADQUARTERS
Telephone: (970) 669-3050
FAX: (970) 669-2932

Method 8016

DPD Method¹

Powder Pillows or AccuVac[®] Ampuls

(0.05 to 4.50 mg/L)

Scope and Application: For testing bromine residuals (including hypobromite, hypobromous acid and bromamines) used as disinfectants in process waters, treated water, estuary water, and seawater

¹ Adapted from *Standard Methods for the Examination of Water and Wastewater*



Test Preparation

Before starting the test:

Analyze samples immediately. Do not preserve for later analysis.

For more accurate results, determine a reagent blank value for each new lot of reagent. Follow the procedure using deionized water in place of the sample. Subtract the reagent blank value from the final results or perform a reagent blank adjust.

If the sample temporarily turns yellow after reagent addition, dilute a fresh sample and repeat the test. A slight loss of bromine may occur because of the dilution. Multiply the result by the dilution factor.

Collect the following items:

Quantity

Powder Pillow Test:	
DPD Total Chlorine Reagent Powder Pillows	1
Sample cells, 1-in. square, 10-mL	2
AccuVac Test:	
DPD Total Chlorine Reagent AccuVac [®] Ampuls	1
Beaker, 50-mL (AccuVac test)	1
Sample cell, 10-mL round, with cap	1
Stopper, 18 mm tube	1

Note: Reorder information for consumables and replacement items is on page 5.

Powder Pillows

Method 8016



1. Press **STORED PROGRAMS**.

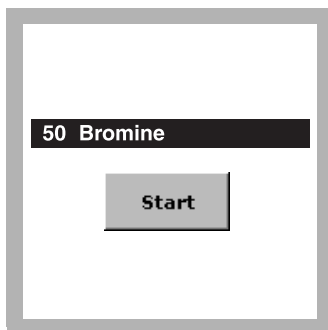

2. Select the test.

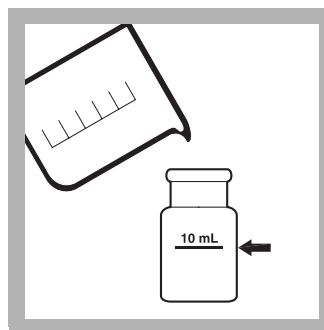

3. Fill a square sample cell with 10 mL of sample.

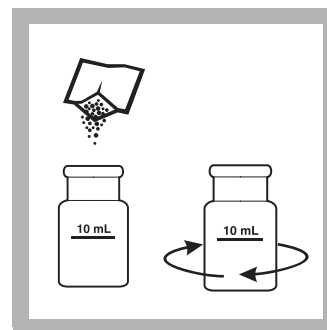

4. **Prepared Sample:** Add the contents of one DPD Total Chlorine Powder Pillow to the sample cell.

Swirl for 20 seconds to mix.

A pink color will develop if bromine is present.

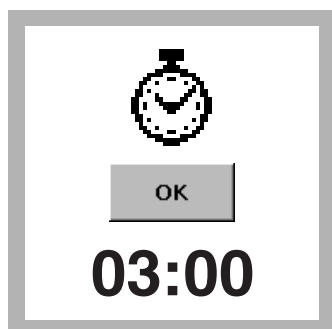

5. Press **TIMER>OK**.
A three-minute reaction period will begin.
Perform steps 6–7 during the reaction period.

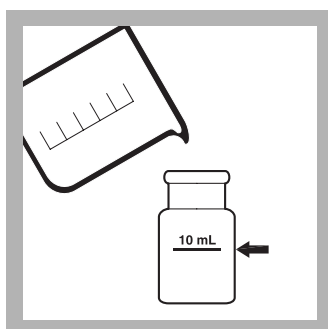

6. **Blank Preparation:** Fill a second square sample cell with 10 mL of sample.

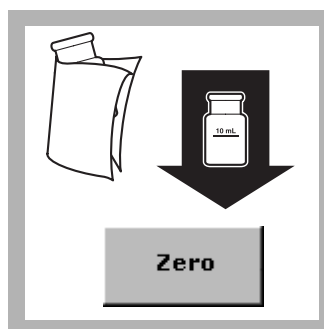

7. Wipe the blank and insert it into the cell holder with the fill line facing right.
Press **ZERO**.
The display will show:

0.00 mg/L Br₂

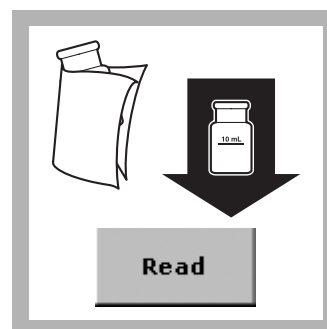

8. Within three minutes after the timer expires, wipe the prepared sample and insert it into the cell holder with the fill line facing right.

Press **READ**.

Results are in mg/L Br₂.

AccuVac® Ampul

Method 8016

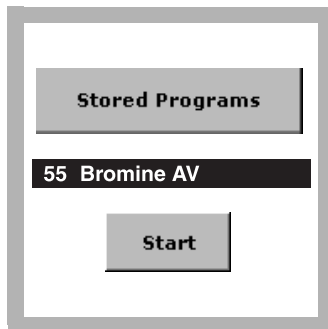

1. Select the test.

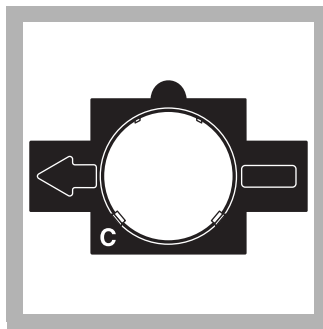

2. Insert Adapter C.

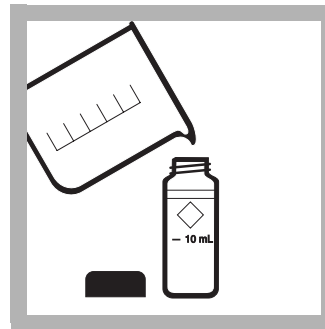

3. **Blank Preparation:**
Fill a round 1-inch sample cell with 10 mL of sample.



4. **Prepared Sample:**
Collect at least 40 mL of sample in a 50-mL beaker.

Fill a DPD Total Chlorine Reagent AccuVac Ampul with sample. Keep the tip immersed while the Ampul fills completely.



5. Quickly invert the Ampul several times to mix.
A pink color will develop if bromine is present.

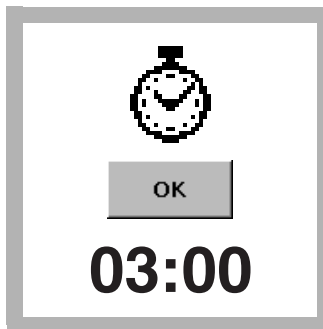

6. Press **TIMER>OK**.
A three-minute reaction period will begin.
Perform steps 7 during the reaction period.

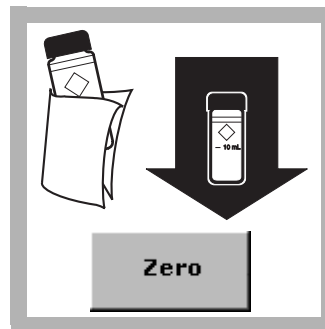

7. Wipe the blank and insert it into the cell holder.
Press **ZERO**.
The display will show:
0.00 mg/L Br₂



8. Within three minutes after the timer expires, wipe the Ampul and insert it into the cell holder.
Press **READ**.
Results are in mg/L Br₂.

Interferences

Table 1 Interfering Substances and Levels

Interfering Substance	Interference Levels and Treatments
Acidity	Greater than 150 mg/L CaCO ₃ . May not develop full color or color may fade instantly. Neutralize to pH 6–7 with 1 N Sodium Hydroxide ¹ . Determine amount to be added on separate sample aliquot, then add the same amount to the sample being tested. Correct for volume addition.
Alkalinity	Greater than 250 mg/L CaCO ₃ . May not develop full color or color may fade instantly. Neutralize to pH 6–7 with 1 N Sulfuric Acid ¹ . Determine amount to be added on separate sample aliquot, then add the same amount to the sample being tested. Correct for volume addition.
Chlorine	Interferes at all levels
Chlorine Dioxide	Interferes at all levels
Chloramines, organic	May interfere
Hardness	No effect at less than 1000 mg/L as CaCO ₃
Iodine	Interferes at all levels
Manganese, Oxidized (Mn ⁴⁺ , Mn ⁷⁺) or Chromium, Oxidized (Cr ⁶⁺)	<ol style="list-style-type: none"> 1. Adjust sample pH to 6–7. 2. Add 3 drops Potassium Iodide¹ (30-g/L) to a 25-mL sample. 3. Mix and wait one minute. 4. Add 3 drops Sodium Arsenite^{1, 2} (5-g/L) and mix. 5. Analyze 10 mL of the treated sample as described in the procedure. 6. Subtract the result from this test from the original analysis to obtain the correct bromine concentration.
Monochloramine	Interferes at all levels
Ozone	Interferes at all levels
Peroxides	May interfere
Extreme sample pH or highly buffered samples	Adjust to pH 6–7.

¹ See [Optional Reagents and Apparatus on page 5](#).

² Samples treated with sodium arsenite for manganese or chromium interferences will be hazardous wastes as regulated by the Federal RCRA for arsenic (D004).

Sample Collection, Storage, and Preservation

Collect samples in clean, dry glass containers. If sampling from a tap, allow the water to flow at least 5 minutes to ensure a representative sample. Avoid excessive agitation and exposure to sunlight when sampling. Allow several volumes of water to overflow the container and cap the container so there is no headspace above the sample. If sampling with a DR cell, rinse the cell several times with the sample, then carefully fill to the 10-mL mark. Proceed with the analysis immediately.

Summary of Method

Bromine residuals reacts with DPD (N,N-diethyl-p-phenylenediamine) to form a pink color which is proportional to the total bromine concentration. Test results are measured at 530 nm.

Consumables and Replacement Items

Required Reagents

Description	Quantity/Test	Unit	Cat. No.
DPD Total Chlorine Reagent Powder Pillows	1	100/pkg	21056-69
OR			
DPD Total Chlorine Reagent AccuVac® Ampuls	1	25/pkg	25030-25

Required Apparatus (Powder Pillows)

Description	Quantity/Test	Unit	Cat. No.
Sample Cells, 1-inch square, 10 mL, matched pair	2	2/pkg	24954-02

Required Apparatus (AccuVac)

Description	Quantity/Test	Unit	Cat. No.
Adapter, 1-inch round, for AccuVac Ampuls	1	each	LZV584
Beaker, 50-mL	1	each	500-41H
Sample Cell, 10-mL, with cap	1	each	21228-00

Recommended Standards

Description	Unit	Cat. No.
Chlorine Standard Solution, 2-mL Voluette® Ampule, 25–30 mg/L	20/pkg	26300-20

Optional Reagents and Apparatus

Description	Cat. No.
Chlorine Demand-Free Water, 500 mL	26415-49
Cylinder, mixing, 25 mL	20886-40
Cylinder, mixing, 50 mL	1896-41
Potassium Iodide, 30 g/L, 100 mL	343-32
Sodium Arsenite, 5 g/L, 100 mL	1047-32
Sodium Hydroxide, 1 N, 100 mL	1045-32
Sulfuric Acid, 1 N, 100 mL	1270-32
Stopper for 18 mm tube, 6/pkg	1731-06



FOR TECHNICAL ASSISTANCE, PRICE INFORMATION AND ORDERING:

In the U.S.A. – Call toll-free 800-227-4224
Outside the U.S.A. – Contact the HACH office or distributor serving you.
On the Worldwide Web – www.hach.com; E-mail – techhelp@hach.com

HACH COMPANY
WORLD HEADQUARTERS
Telephone: (970) 669-3050
FAX: (970) 669-2932

Method 8017

Dithizone Method¹

Powder Pillows

(0 to 80.0 µg/L)

Scope and Application: For water and wastewater; digestion is required to determine total cadmium.

¹ Adapted from Standard Methods for the Examination of Water and Wastewater.



Test Preparation

Before starting the test:

For more accurate results, determine a reagent blank value for each new lot of reagent. Follow the procedure using deionized water instead of the sample.

Clean all glassware with 6 N Hydrochloric Acid Solution and rinse with deionized water.

Cloudy and turbid samples may require filtering before running the test. Report results as µg/L soluble cadmium. Use glass membrane type filter to avoid loss of cadmium by adsorption onto the filter paper.

If samples cannot be analyzed immediately, see [Sample Collection, Preservation, and Storage on page 4](#). Adjust the pH of preserved samples before analysis.

The Flow Cell and Sipper Modules cannot be used with this procedure.

The DithiVer powder will not completely dissolve in the chloroform. For further notes see [DithiVer Solution Preparation and Storage on page 5](#).

Read the MSDS before testing. Spilled reagent will affect test accuracy and is hazardous to skin and other materials.

In bright light conditions (e.g. direct sunlight) it may be necessary to close the cell compartment with the protective cover during measurements.

Collect the following items:

Quantity

Citrate buffer powder pillows	1
Chloroform	30 mL
DithiVer Metals Reagent powder pillows	1
Potassium Cyanide	0.1 g
Sodium Hydroxide solution, 50%	20 mL
Cotton balls	1
Clippers	1
Cylinder, 25-mL graduated	1
Cylinder, 250-mL graduated	1
Cylinder, 50-mL graduated mixing	1
Funnel, 500-mL separatory	1
Sample Cells	2
Spoon, measuring, 0.1-g	1
Support ring (4-inch) and stand (5 x 8-inch base)	1

Note: Reorder information for consumables and replacement items is on [page 6](#).

Powder Pillows

Method 8017

DANGER

Cyanide is a deadly poison. Use a fume hood. Maintain cyanide solutions at pH 11 or greater to prevent formation of cyanide gas.



1. Press **STORED PROGRAMS**.

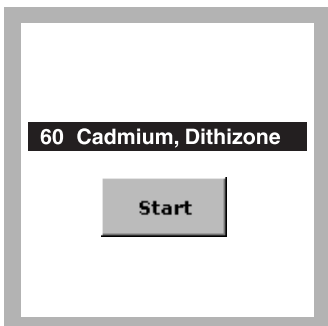

2. Select the test.

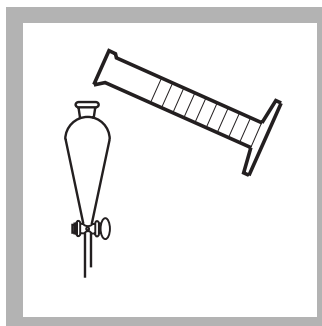

3. Fill a 250-mL graduated cylinder to the 250-mL mark with sample. Pour the sample into a 500-mL separatory funnel.

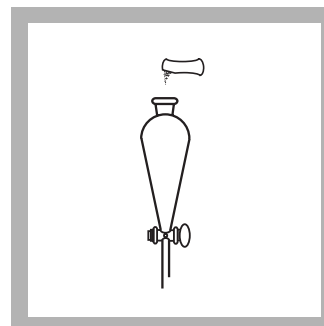

4. Add the contents of one Buffer Powder Pillow for heavy metals, citrate type. Stopper the funnel and shake to dissolve.

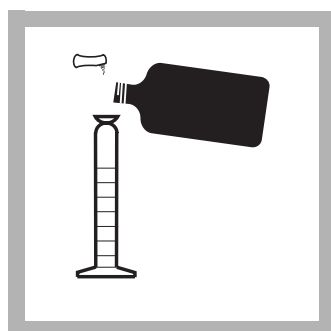

5. DithiVer Solution Preparation:
Add 50 mL of chloroform to a 50-mL mixing graduated cylinder. Add the contents of one DithiVer Metals Reagent Powder Pillow. Stopper the cylinder. Invert several times to mix.

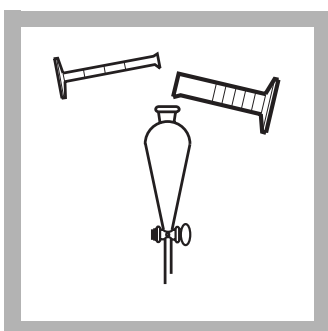

6. Add 20 mL of 50% Sodium Hydroxide Solution. Add a 0.1-g scoop of potassium cyanide to the funnel. Stopper. Shake vigorously for 15 seconds.

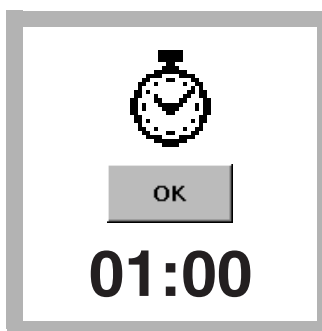

7. Remove the stopper. Press **TIMER>OK**. A 1-minute reaction period will begin.

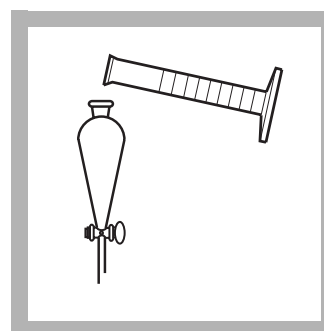

8. Add 30 mL of the DithiVer solution to the 500-mL separatory funnel. Stopper, invert, and open stopcock to vent. Close the stopcock and shake funnel once or twice; vent again.

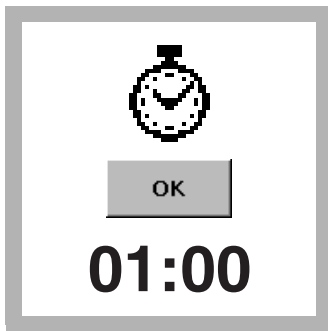

9. Press TIMER>OK.

Close the stopcock and shake the funnel vigorously during the 1 minute time period.

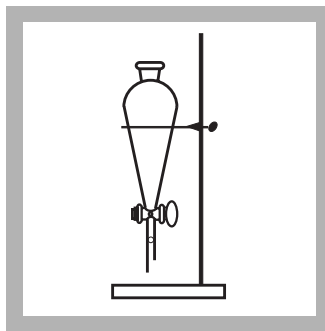

10. Press TIMER>OK

and allow the funnel to stand undisturbed until the timer expires.

The bottom (chloroform) layer will be orange to pink if cadmium is present.

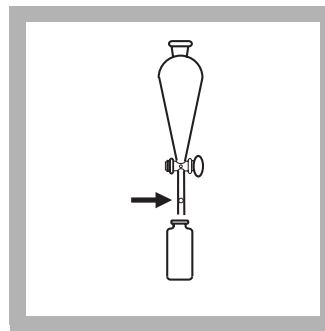

11. Prepared Sample:

Insert a cotton plug the size of a pea into the delivery tube of the funnel and slowly drain the bottom (chloroform) layer into a dry 25-mL sample cell (the prepared sample). Stopper.

The cadmium-dithizone complex is stable for more than one hour if the sample cell is kept tightly capped and out of direct sunlight.

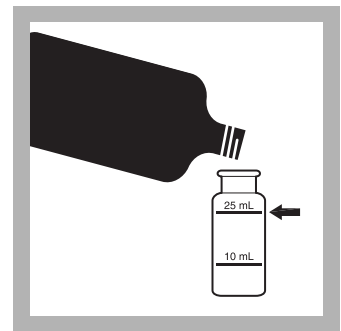

12. Blank Preparation:

Fill a dry 25-mL sample cell with chloroform. Stopper.



13. Insert the blank into the cell holder with the fill line facing right.

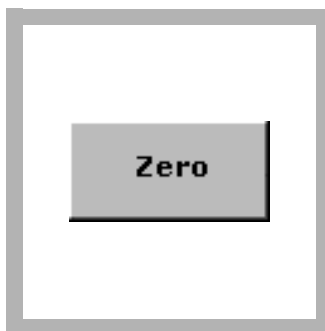

14. Press ZERO.

The display will show:
0.0 µg/L Cd



15. Insert the prepared sample into the cell holder with the fill line facing right.

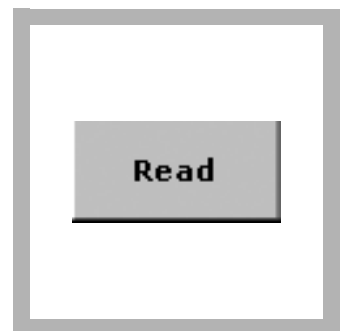

16. Press READ.

Results are in µg/L cadmium.

Interferences

Table 1 Interfering Substances and Levels

Interfering Substance	Interference Levels and Treatments
Highly buffered samples or Extreme sample pH	May exceed the buffering capacity of the reagents and require sample pretreatment.
Bismuth	Greater than 80 mg/L. See treatment below.
Copper	Greater than 2 mg/L. See treatment below.
Mercury	All levels. See treatment below.
Silver	Greater than 2 mg/L. See treatment below.

Table 2 Substances That Do Not Interfere

Aluminum	Lead
Antimony	Magnesium
Arsenic	Manganese
Calcium	Nickel
Chromium	Tin
Cobalt	Zinc
Iron	

To eliminate interference from the metals in [Table 1](#), insert the following steps into the procedure after step [5](#).

1. Measure about 5-mL of the DithiVer solution into the separatory funnel. Stopper the funnel, invert and open the stopcock to vent. Close the stopcock and shake the solution vigorously for 15 seconds. Allow the funnel to stand undisturbed until the layers separate (about 30 seconds). A yellow, red, or bronze color in the bottom (chloroform) layer confirms the presence of interfering metals. Draw off and collect the bottom (chloroform) layer for proper disposal.
2. Repeat extraction with fresh 5 mL portions of the DithiVer solution (discarding the bottom layer each time) until the bottom layer shows a pure dark green color for three successive extracts. Extractions can be repeated several times without appreciably affecting the amount of cadmium in the sample.
3. Extract the solution with several 2- or 3-mL portions of pure chloroform to remove any remaining DithiVer, collecting the bottom layer each time for proper disposal.
4. Continue with step [6](#) of the procedure.
5. In step [8](#), substitute 28.5 mL of DithiVer solution for the 30 mL.
6. Continue with step [9](#) of the procedure.

Sample Collection, Preservation, and Storage

Collect samples in an acid-washed glass or plastic containers. Adjust the pH to 2 or less with nitric acid (about 2 mL per liter). Store preserved samples up to six months at room temperature. Adjust the pH to 2.5 with 5.0 N sodium hydroxide before analysis. Correct the test result for volume additions.

Dithiver Solution Preparation and Storage

Store DithiVer Powder Pillows away from light and heat. A convenient way to prepare this solution is to add the contents of 16 DithiVer Metals Reagent Powder Pillows to a 500-mL bottle of chloroform and invert several times until well mixed (carrier powder may not dissolve completely). Store dithizone solution in an amber glass bottle. This solution is stable for 24 hours.

Accuracy Check

1. After reading test results, leave the sample cell (unspiked sample) in the instrument.
2. Press **OPTIONS>MORE**. Press **STANDARD ADDITIONS**. A summary of the standard additions procedure will appear.
3. Press **OK** to accept the default values for standard concentration, sample volume, and spike volumes. Press **EDIT** to change these values. After values are accepted, the unspiked sample reading will appear in top row. See the user manual for more information.
4. Snap the neck off a Cadmium Voluette Ampule Standard, 25-mg/L Cd (25,000-µg/L Cd).
5. Use the TenSette Pipet to add 0.1 mL, 0.2 mL, and 0.3 mL of standard, respectively to three 250-mL samples and mix each thoroughly.
6. Analyze each standard addition sample as described above. Accept the standard additions reading by pressing **READ**. Each addition should reflect approximately 100% recovery.
7. After completing the sequence, press **GRAPH** to view the best-fit line through the standard additions data points, accounting for the matrix interferences. Press **IDEAL LINE** to view the relationship between the sample spikes and the "Ideal Line" of 100% recovery.

Standard Solution Method

1. Prepare a 5.0-mg/L cadmium standard solution by pipetting 5.00 mL of Cadmium Standard Solution, 100-mg/L Cd, into a 100-mL volumetric flask. Dilute to the mark with deionized water. Prepare this solution daily.
2. Pipet 2.00 mL of the 5.0-mg/L Cadmium Standard Solution into 248 mL of deionized water in a 500-mL separatory funnel. This is a 40-µg/L cadmium solution. Perform the cadmium test on this solution beginning with step 4 of the procedure.
3. To adjust the calibration curve using the reading obtained with the standard solution, press **OPTIONS>MORE** on the current program menu. Press **STANDARD ADJUST**.
4. Press **ON**. Press **ADJUST** to accept the displayed concentration. If an alternate concentration is used, press the number in the box to enter the actual concentration, then press **OK**. Press **ADJUST**.

Summary of Method

The dithizone method is designed for the determination of cadmium in water and wastewater. The DithiVer Metals Reagent is a stable powder form of dithizone. Cadmium ions in basic solution react with dithizone to form a pink to red cadmium-dithizonate complex, which is extracted with chloroform. Test results are measured at 515 nm.

Pollution Prevention and Waste Management

Both chloroform (D022) and cyanide (D003) solutions are regulated as hazardous wastes by the Federal RCRA. Do not pour these solutions down the drain. Chloroform solutions and the cotton plug used in the delivery tube of the separatory funnel should be collected for disposal with laboratory solvent waste. Collect the cyanide solution as a reactive waste. Be sure that cyanide solutions are stored in a caustic solution with a pH >11 to prevent potential release of hydrogen cyanide gas. See the current MSDS for disposal information.

Consumables and Replacement Items

Required Reagents

Description	Quantity/Test	Unit	Cat. No.
Cadmium Reagent Set (100 Tests) Includes:(1) 14202-99, (1) 14458-17, (1) 12616-99, (1) 767-14, (4) 2180-49, (1) 2572-01	—	—	22422-00
Buffer Powder Pillows, citrate	1	100/pkg	14202-99
Chloroform, ACS	30 mL	4 L	14458-17
DithiVer Metals Reagent Powder Pillows	1	100/pkg	12616-99
Potassium Cyanide	0.1 g	125 g	767-14
Sodium Hydroxide Solution, 50%	20 mL	500 mL	2180-49
Cotton Balls, absorbent	1	100/pkg	2572-01

Required Apparatus

Description	Quantity/Test	Unit	Cat. No.
Clippers, for opening powder pillows	1	each	968-00
Cylinder, graduated, 25-mL	1	each	508-40
Cylinder, graduated, 250-mL	1	each	508-46
Cylinder, graduated, mixing, 50-mL	1	each	1896-41
Sample Cell, 1-in. Square, 25 mL with cap	2	2/pkg	26126-02
Funnel, separatory, 500-mL	1	each	520-49
Spoon, measuring, 0.1-g	1	each	511-00
Support Ring, 4"	1	each	580-01
Support Ring Stand, 5" x 8" base	1	each	563-00

Recommended Reagents and Standards

Description	Unit	Cat. No.
Cadmium Standard Solution, 100-mg/L Cd	100 mL	14024-42
Cadmium Standard Solution, 10-mL Voluette Ampule, 25-mg/L Cd	16/pkg	14261-10
Chloroform, ACS	500 mL	14458-49
Hydrochloric Acid Solution, 6.0 N	500 mL	884-49
Sodium Hydroxide Standard Solution, 5.0 N	100 mL MDB	2450-32
Sodium Hydroxide Standard Solution, 5.0 N	59 mL SCDB	2450-26
Water, deionized	4 L	272-56

Recommended Apparatus

Description	Unit	Cat. No.
Ampule Breaker Kit	each	21968-00
Cylinder, graduated, 5-mL	each	508-37
Filter Discs, glass, 47 mm	100/pkg	2530-00
Filter Holder, glass, for 47-mm filter	each	2340-00
Flask, Erlenmeyer, 500-mL	each	505-49
Flask, filtering, 500-mL	each	546-49
Flask, volumetric, Class A, 100-mL	each	14574-42
Flask, volumetric, Class A, 250-mL	each	14574-46
Flask, volumetric, Class A, 1000-mL, with glass stopper	each	14574-53
Hot Plate, 3½-in. diameter, 120 VAC, 50/60 Hz	each	12067-01
Hot Plate, 3½-in. diameter, 240 VAC, 50/60 Hz, variable control	each	12067-02
pH Paper, pH 1.0 to 11.0	5 rolls/pkg	391-33
pH Meter, <i>sens^{ion}</i> [™] 1, portable	each	51700-00
Pipet Filler, safety bulb	each	14651-00
Pipet, serological, 2-mL	each	532-36
Pipet, TenSette®, 0.1 to 1.0 mL	each	19700-01
Pipet Tips, for TenSette Pipet 19700-01	50/pkg	21856-96
Pipet, volumetric, 2.00-mL, Class A	each	14515-36
Pipet, volumetric, 3.00-mL, Class A	each	14515-03
Pipet, volumetric, 6.00-mL, Class A	each	14515-06
Pipet, volumetric, 8.00-mL, Class A	each	14515-08
Pipet, volumetric, 9.00-mL, Class A	each	14515-09
Pipet, volumetric, 10.00-mL, Class A	each	14515-38
Pipet, volumetric, 20.00-mL, Class A	each	14515-20
Tongs, crucible, 9-inch	each	569-00



FOR TECHNICAL ASSISTANCE, PRICE INFORMATION AND ORDERING:

In the U.S.A. – Call toll-free 800-227-4224
Outside the U.S.A. – Contact the HACH office or distributor serving you.
On the Worldwide Web – www.hach.com; E-mail – techhelp@hach.com

HACH COMPANY
WORLD HEADQUARTERS
Telephone: (970) 669-3050
FAX: (970) 669-2932

Method 10217

Cation Method

TNTplus™ 852

(0.02 to 0.30 mg/L Cd)

Scope and Application: For wastewater and process control.



Test Preparation

Before starting the test:

Important Note: Install the light shield in Cell Compartment #2 before performing this test.

Please read Safety Advice and Expiration Date on package.

Recommended sample pH is 3–10.

Recommended sample and reagent temperature is 15–25 °C (59–77 °F).

Recommended reagent storage is 2–8 °C (35.6–46.4 °F).

Undissolved cadmium or cadmium bound in complexes can only be determined after digestion with Metals Prep Set TNT890 has been performed.

Samples with calcium and magnesium concentrations greater than 50 mg/L require the use of the Calcium Separation Set TNT892.

TNTplus methods are activated directly from the Main Menu when the sample vial is inserted into the sample cell holder.

Collect the following items:

Quantity

Cadmium TNT852 Reagent Set	1
Light Shield	1
Pipettor, variable 1–5 mL	1
Pipettor tips for 1–5 mL pipettor	2
Pipettor, variable 100–1000 µL	1
Pipettor tips for 100–1000 µL pipettor	1
Pipet, volumetric, 10 mL	1
Safety pipet bulb	1

Note: Reorder information for consumables and replacement items is on page 4.

TNTplus

Method 10217

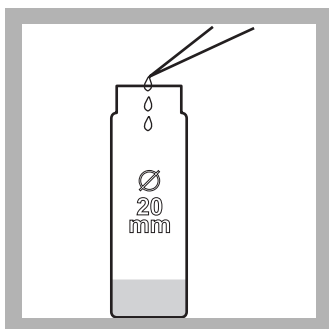

1. Pipet 10 mL of sample into the 20-mm reaction tube.

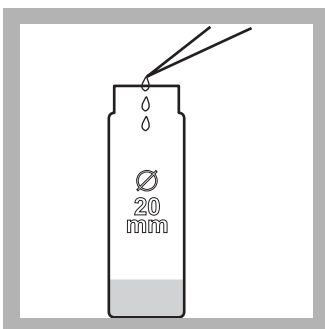

2. Pipet 1 mL of Solution A into the 20-mm reaction tube.

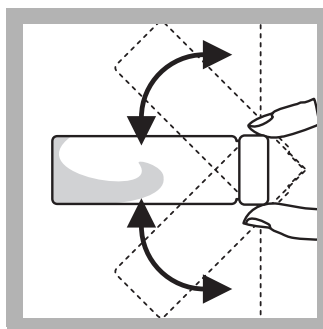

3. Cap the reaction tube and invert 2–3 times.

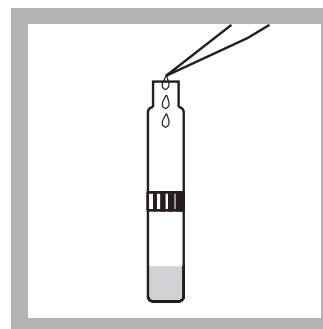

4. Pipet 0.4 mL of Solution B into a sample vial.

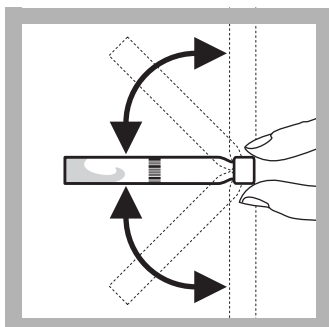

5. Cap and invert the vial 2–3 times.

Install the Light Shield in Cell Compartment #2.



6. Thoroughly clean the outside of the vial and insert it into the sample cell holder. The instrument reads the barcode, then selects the method and sets the blank.

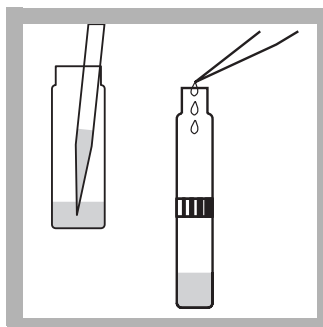

7. Remove the vial from the cell holder and pipet 4.0 mL of the pretreated sample from the 20-mm reaction tube in step 3 into the vial.

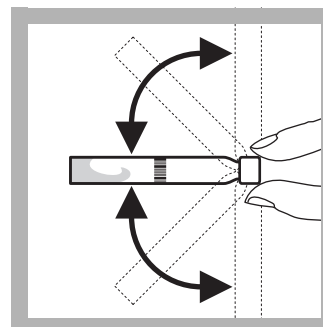

8. Cap the vial and invert the vial 2–3 times.

Wait **30 seconds** before proceeding to step 9.

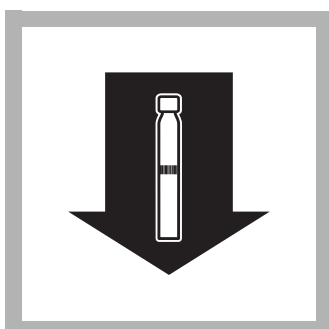

9. Insert the prepared vial into the cell holder. The instrument reads the barcode, then reads the sample.

Results are in mg/L cadmium.

Reagent Blanks

A reagent blank can be measured, and the value subtracted from the results of each test performed using the same reagent lot number. Use deionized water in place of sample and run the procedure as described.

To subtract the value of the blank from a series of measurements, measure the blank per step 9. Press **OPTIONS>MORE>REAGENT BLANK**. Press **ON**. The measured value of the blank should be displayed in the highlighted box. Press **OK** to accept this value. The reagent blank value will now be subtracted from all results until the function is turned off, or a different method is selected. Alternately, the blank can be recorded and entered at any later time by pressing the highlighted box and using the keypad to enter the value.

Interferences

The ions listed in [Table 1](#) have been individually checked up to the given concentrations and do not cause interference. Cumulative effects and the influence of other ions have not been determined.

Measurement results can be verified using sample dilutions or standard additions.

Table 1 Interfering Substances and Levels

Interfering Substance	Interference Level
SO ₄ ²⁻	1000 mg/L
Ca ²⁺ , Mg ²⁺	50 mg/L
Fe ²⁺ , Cu ²⁺ , Ni ²⁺ , Zn ²⁺ , Pb ²⁺ , Co ²⁺ , Ag ⁺ , Au ⁺ , Cr ⁶⁺	25 mg/L
Mn ²⁺	2 mg/L

Sample Collection, Preservation, and Storage

Collect samples in an acid-washed glass or plastic containers. Adjust the pH to 2 or less with nitric acid (about 2 mL per liter). Store preserved samples up to six months at room temperature. Adjust the pH to between 3–6 with 5.0 N sodium hydroxide before analysis. Correct the test result for volume additions.

Accuracy Check

Standard Solution Method

To check the accuracy of the method:

1. Prepare a 0.20 mg/L cadmium standard solution by pipetting 1.0 mL of a 100 mg/L cadmium standard solution into a 500 mL volumetric flask.
2. Dilute to volume with deionized water. Use 10 mL of this standard in place of the sample in the procedure.

Summary of Method

Cadion forms a complex with cadmium. The reduction in the color intensity of the cadion is used for the determination of cadmium. Test results are measured at 552 nm.

Cadmium (0.02 to 0.30 mg/L Cd)

Consumables and Replacement Items

Required Reagents

Description	Quantity/Test	Unit	Cat. No.
Cadmium TNT852 Reagent Set	1	25/pkg	TNT852

Required Apparatus

Description	Quantity/Test	Unit	Cat. No.
Light Shield	1	each	LZV646
Pipettor, variable volume, 1–5 mL	1	each	27951-00
Pipettor Tips, for 27951-00 pipettor	2	100/pkg	27952-00
Pipettor, variable volume, 100–1000 µL	1	each	27949-00
Pipettor Tips, for 27949-00 pipettor	1	400/pkg	27952-00
Pipet, volumetric 10 mL	1	each	14515-38
Pipet filler, safety bulb	1	each	14651-00

Recommended Reagents and Standards

Description	Unit	Cat. No.
Cadmium Standard Solution, 100-mg/L Cd	100 mL	14024-42
Cadmium Standard Solution, 10-mL Voluette Ampule, 25-mg/L Cd	16/pkg	14261-10
Nitric Acid, ACS	500 mL	152-49
Sodium Hydroxide Standard Solution, 5.0 N	100 mL MDB	2450-32
Sodium Hydroxide Standard Solution, 5.0 N	59 mL SCDB	2450-26
Water, deionized	4 L	272-56

Optional Reagents and Apparatus

Description	Unit	Cat. No.
Bottle, sampling, low density poly, w/cap, 500 mL	12/pkg	20870-79
Calcium Separation Set TNT892	each	TNT892
Flask, volumetric 500 mL	each	14574-49
Metals Prep Set TNT890	each	TNT890
Pipet, volumetric 1.0 mL	each	14515-35
Test Tube Rack for 13-mm vials	each	24979-00



FOR TECHNICAL ASSISTANCE, PRICE INFORMATION AND ORDERING:
In the U.S.A. – Call toll-free 800-227-4224
Outside the U.S.A. – Contact the HACH office or distributor serving you.
On the Worldwide Web – www.hach.com; E-mail – techhelp@hach.com

HACH COMPANY
WORLD HEADQUARTERS
Telephone: (970) 669-3050
FAX: (970) 669-2932

Chloramine (Mono)

Indophenol Method¹
HR (0.1 to 10.0 mg/L Cl₂)

Method 10172

Scope and Application: Chlorinated wastewater.

¹ Patent Pending



Test Procedure

Before starting the test:

Important Note: Install the light shield in Cell Compartment #2 before performing this test.

For more accurate results, determine a reagent blank value for each new lot of reagent. Follow the procedure using deionized water in place of the sample. Subtract the reagent blank value from the final results or perform a reagent blank adjust.

Collect the following items:

Quantity

High-range Monochloramine Diluent Vials	1
Monochlor F Reagent Pillow	1
Funnel, micro	1
Light Shield	1
Pipet, Mohr glass, 2.00 mL	1
Test Tube Rack	1

Note: Reorder information for consumables and replacement items is on page 5.

Test 'N Tube

Method 10172

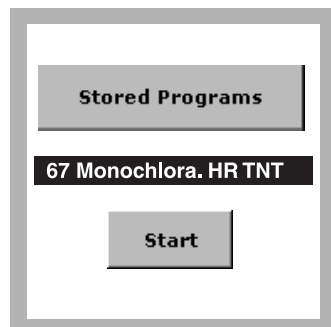

1. Select the test.

Install the Light Shield in Cell Compartment #2.

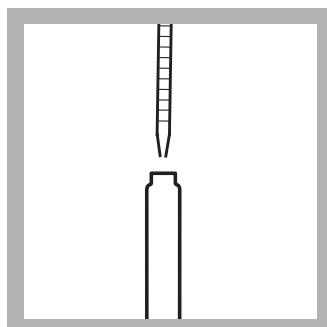

2. Remove the cap from one HR Monochloramine Diluent vial. Use a glass pipet to add 2.0 mL sample to the vial. Re-cap and invert several times to mix.

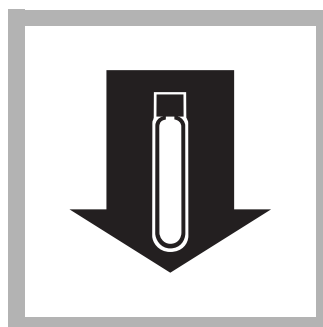

3. Wipe the vial and insert it into the 16 mm cell holder.

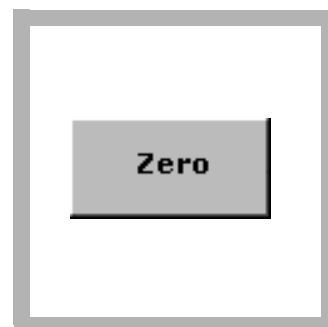

4. Press ZERO.

The display will show:
0.0 mg/L Cl₂

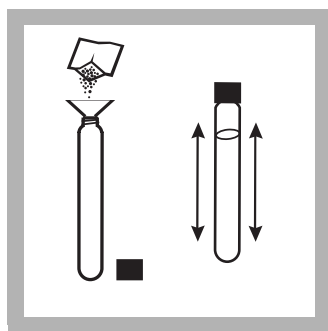

5. Remove the vial from the holder. Using a micro-funnel, add the contents of one Monochlor F pillow to the sample. Cap and shake the cell about 20 seconds to dissolve.

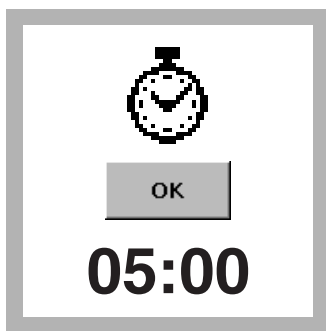

6. Press **TIMER>OK**.
A 5-minute reaction period will begin.

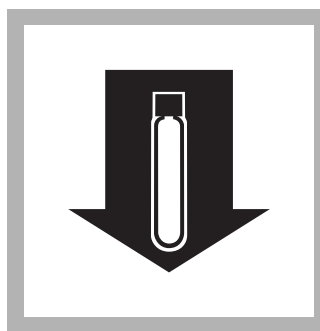

7. After the timer expires, re-insert the vial into the cell holder.

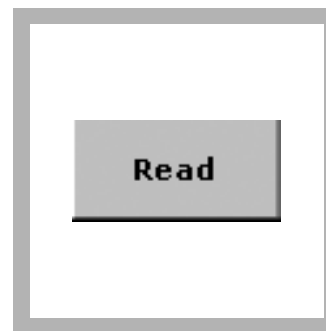

8. Press **READ**.
Results are in mg/L Cl₂.

Interferences

The substances in [Table 1](#) have been tested for interference and do not interfere at or below the indicated levels:

Table 1 Non-interfering Substances

Substance	Maximum Level Tested
Alanine	1 mg/L N
Aluminum	10 mg/L
Bromide	100 mg/L Br ⁻
Bromine	15 mg/L Br ₂
Calcium	1000 mg/L as CaCO ₃
Chloride	18,000 mg/L
Chlorine Dioxide	5 mg/L ClO ₂
Chromium (III)	5 mg/L
Copper	10 mg/L
Cyanide	10 mg/L CN ⁻
Dichloramine	10 mg/L as Cl ₂
Fluoride	5 mg/L
Free Chlorine	10 mg/L Cl ₂
Glycine	1 mg/L N
Iron (II)	10 mg/L
Iron (III)	10 mg/L
Magnesium	1000 mg/L as CaCO ₃
Manganese (VII)	10 mg/L
Lead	10 mg/L
Nitrate	100 mg/L N
Nitrite	50 mg/L N
Phosphate	100 mg/L PO ₄

Table 1 Non-interfering Substances (continued)

Substance	Maximum Level Tested
Silica	100 mg/L SiO ₂
Sulfate	2600 mg/L
Sulfite	50 mg/L SO ₃ ²⁻
Tyrosine	1 mg/L N
Urea	10 mg/L N
Zinc	5 mg/L

Table 2 describes suggested treatments for interfering substances.

Table 2 Interfering Substances and Suggested Treatments

Interfering Substance and Effects	Interference Level	Recommended Treatment
Ozone	–	Above 1 mg/L Usually does not coexist with monochloramine.
Sulfide	+	Turns a “rust” color if present. Usually does not coexist with monochloramine.
Thiocyanate	–	Above 0.5 mg/L This method will tolerate up to 2 mg/L.

Sampling and Storage

Analyze samples for monochloramine immediately after collection. Rinse the sample container several times with sample, letting the container overflow each time. If sampling from a tap, let the water flow for at least 5 minutes, then cap the container so that there is no head space (air) above the sample.

Accuracy Check

To check test accuracy, prepare the following 4.5-mg/L (as Cl₂) monochloramine standard immediately before use.

1. Add the contents of one Buffer Powder Pillow, pH 8.3 to about 50-mL of organic-free water in a clean 100-mL Class A volumetric flask. Swirl to dissolve the powder.
2. Using a Class A volumetric pipet, transfer 2.00 mL of Nitrogen, Ammonia Standard Solution, 100-mg/L as NH₃-N into the flask.
3. Dilute to volume with organic-free water, cap and mix thoroughly. This is a 2.00-mg/L buffered ammonia standard.
4. Pipet 50.00 mL of the buffered ammonia standard into a clean 100-mL beaker. Add a stir bar.
5. Obtain a recent lot of Chlorine Solution Ampules, 50–75 mg/L, and note the actual free chlorine concentration for this lot.
6. Calculate the amount of Chlorine Solution to be added to the ammonia standard using the following equation:

$$\text{mL chlorine solution required} = \frac{455}{\text{free chlorine concentration}}$$

7. Open an ampule and use a glass Mohr pipet to add the calculated amount of Chlorine Solution slowly to the ammonia standard, while mixing at medium speed on a stir-plate.
8. Allow the monochloramine solution to mix for 1 minute after all Chlorine Solution is added.
9. Quantitatively transfer the monochloramine solution to a clean 100-mL Class A volumetric flask. Dilute to the mark with organic-free water, cap, and mix thoroughly. This is a nominal 4.5-mg/L (as Cl₂) monochloramine standard.
10. Use this standard within 1 hour of preparation. Analyze according to the Low Range Monochloramine procedure described above.
11. To adjust the calibration curve using the reading obtained with the 4.5-mg/L standard solution, press **OPTIONS>MORE** on the current program menu. Press **STANDARD ADJUST**.
12. Press **ON**. Press **ADJUST** to accept the displayed concentration (the value depends on the selected chemical form). If an alternate concentration is used, press the number in the box to enter the actual concentration, then press **OK**. Press **ADJUST**.

Summary of Method

The sample is first diluted in a Test 'N Tube. In the presence of a cyanoferrate catalyst, monochloramine (NH₂Cl) in the sample reacts with a substituted phenol to form an intermediate monoimine compound. The intermediate couples with excess substituted phenol to form a green-colored indophenol, which is proportional to the amount of monochloramine present in the sample. Test results are measured at 655 nm.

Consumables and Replacement Items

Required Reagents

Description	Quantity/Test	Unit	Cat. No.
HR Monochloramine Test 'N Tubes, 50 tests, includes:	—	—	28051-45
(50) HR Monochloramine Diluent Vials ¹	1	50/pkg	—
Funnel, micro	1	each	25843-35
Monochlor F Reagent Pillows	1	50/pkg	28022-46

¹ Not sold separately

Required Apparatus

Description	Quantity/Test	Unit	Cat. No.
Light Shield	1	each	LZV646
Pipet, Mohr, glass 2.00 mL	1	each	20936-36
Safety Bulb	—	each	14651-00
Test Tube Rack	1–2	each	18641-00

Recommended Standards and Apparatus

Description	Unit	Cat. No.
Buffer Powder Pillows, pH 8.3	25/pkg	898-68
Chlorine Solution Voluette® Ampule, 50–75 mg/L	16/pkg	14268-10
Nitrogen, Ammonia Standard Solution, 100-mg/L as NH ₃ -N	500 mL	24065-49
Water, organic-free	500-mL	26415-49

Optional Reagents and Apparatus

Description	Cat. No.
Beaker, 100 mL	500-42H
Clippers	968-00
Flask, volumetric, Class A, 100-mL	14574-42
Pipet, Mohr, glass, 5-mL	20934-37
Pipet, volumetric, Class A, 2.00-mL	14515-36
Pipet, volumetric, Class A, 50.00-mL	14515-41
Safety Bulb	14651-00
Stir bar, octagonal	20953-52
Stirrer, magnetic	28812-00
Shears	23694-00



FOR TECHNICAL ASSISTANCE, PRICE INFORMATION AND ORDERING:

In the U.S.A. – Call toll-free 800-227-4224
Outside the U.S.A. – Contact the HACH office or distributor serving you.
On the Worldwide Web – www.hach.com; E-mail – techhelp@hach.com

HACH COMPANY
WORLD HEADQUARTERS
Telephone: (970) 669-3050
FAX: (970) 669-2932

Chloramine (Mono)

Method 10171

Indophenol Method¹

Powder Pillows

LR (0.04 to 4.50 mg/L Cl₂)

Scope and Application: Chloraminated drinking water and chlorinated wastewater

¹ U.S. Patent 6,315,950



Test Preparation

Before starting the test:

For more accurate results, determine a reagent blank value for each new lot of reagent. Follow the procedure using deionized water in place of the sample. Subtract the reagent blank value from the final results or perform a reagent blank adjust.

To determine chloramine (mono) and free ammonia on the same sample, use Method 10200 Nitrogen, Free Ammonia and Chloramine (Mono)

In bright light conditions (e.g. direct sunlight) it may be necessary to close the cell compartment with the protective cover during measurements.

Collect the following items:

Quantity

Monochlor F Reagent Pillow

1

Sample Cell

1

Note: Reorder information for consumables and replacement items is on page 5.

Multi-path Cell

Method 10171

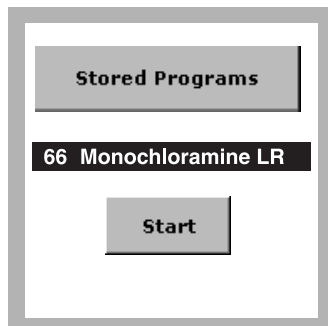

1. Select the test.

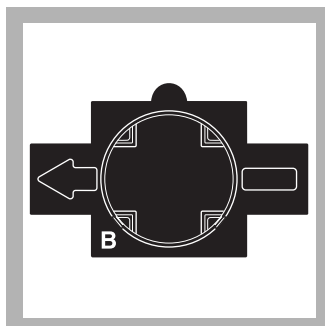

2. Insert Adapter B.

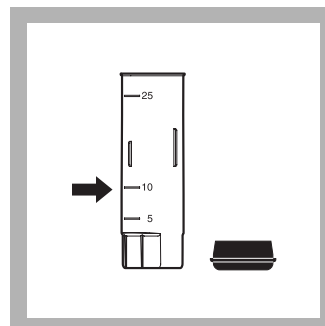

3. Fill the cell to the 10-mL line with sample.

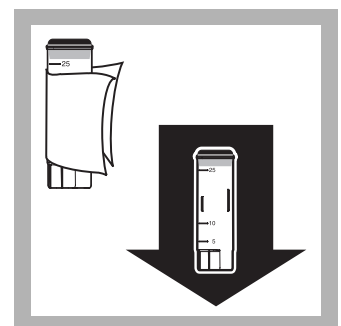

4. Wipe the cell and insert it into the cell holder with the 1-cm (flat) path in line with the indicator arrow on the adapter.

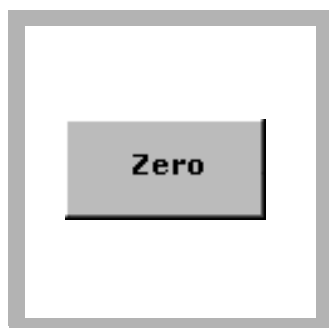

5. Press ZERO.
The display will show:
0.00 mg/L Cl₂

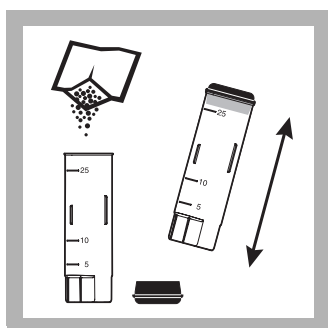

6. Remove the cell and add the contents of one Monochlor-F pillow to the sample. Cap and shake the cell about 20 seconds to dissolve.

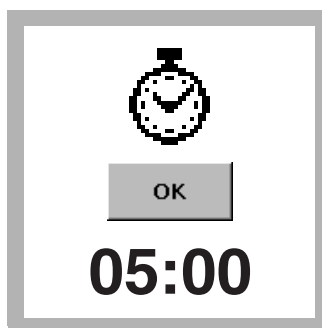

7. Press TIMER>OK.
A 5-minute reaction period will begin. Samples colder than 18 °C will require additional time. See [Table 3](#).

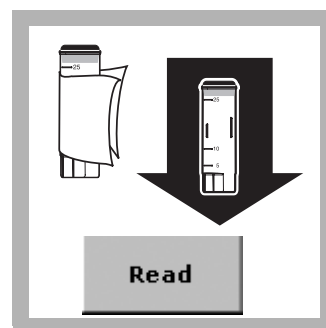

8. After the timer expires, insert the vial into the cell holder with the 1-cm (flat) path in line with the indicator arrow on the adapter.

Press **READ**. Results are in mg/L Cl₂.

Interferences

The substances in [Table 1](#) have been tested for interference and do not interfere at or below the indicated levels. [Table 2](#) suggests treatments for interferences.

Table 1 Non-interfering Substances

Substance	Maximum Level Tested
Alanine	1 mg/L N
Aluminum	10 mg/L
Bromide	100 mg/L Br ⁻
Bromine	15 mg/L Br ₂
Calcium	1000 mg/L as CaCO ₃
Chloride	18,000 mg/L
Chlorine Dioxide	5 mg/L ClO ₂
Chromium (III)	5 mg/L
Copper	10 mg/L
Cyanide	10 mg/L CN ⁻
Dichloramine	10 mg/L as Cl ₂
Fluoride	5 mg/L
Free Chlorine	10 mg/L Cl ₂
Glycine	1 mg/L N
Iron (II)	10 mg/L
Iron (III)	10 mg/L
Lead	10 mg/L
Nitrate	100 mg/L N
Nitrite	50 mg/L N
Phosphate	100 mg/L PO ₄
Silica	100 mg/L SiO ₂
Sulfate	2600 mg/L

Table 1 Non-interfering Substances (continued)

Substance	Maximum Level Tested
Sulfite	50 mg/L SO ₃ ²⁻
Tyrosine	1 mg/L N
Urea	10 mg/L N
Zinc	5 mg/L

Table 2 Interfering Substances and Suggested Treatments

Interfering Substance and Effects		Interference Level	Recommended Treatment
Magnesium	+	Above 400 mg/L CaCO ₃	Add 5 drops Rochelle Salt Solution prior to testing. OR: use the high range (HR) test.
Magnesium (+7)	-	Above 3 mg/L	Use the HR test; it will tolerate up to 10 mg/L.
Ozone	-	Above 1 mg/L	Usually does not coexist with monochloramine.
Sulfide	+	Turns a "rust" color if present.	Usually does not coexist with monochloramine.
Thiocyanate	-	Above 0.5 mg/L	This method will tolerate up to 2 mg/L.

Table 3 Color Development Based on Sample Temperature

Sample Temperature		Development Time (minutes)
°C	°F	
5	40	10
7	42	9
9	48	8
10	50	8
12	54	7
14	58	7
16	61	6
18	68	4
20	73	3
23	75	2.5
25	77	2
greater than 25	greater than 77	2

Sampling and Storage

Analyze samples for monochloramine immediately after collection. Rinse the sample container several times with sample, letting the container overflow each time. If sampling from a tap, let the water flow for at least 5 minutes, then cap the container so that there is no head space (air) above the sample.

Accuracy Check

To check test accuracy, prepare the following 4.5-mg/L (as Cl₂) monochloramine standard immediately before use.

1. Add the contents of one Buffer Powder Pillow, pH 8.3 to about 50-mL of organic-free water in a clean 100-mL Class A volumetric flask. Swirl to dissolve the powder.
2. Using a Class A volumetric pipet, transfer 2.00 mL of Nitrogen, Ammonia Standard Solution, 100-mg/L as NH₃-N into the flask.
3. Dilute to volume with organic-free water, cap and mix thoroughly. This is a 2.00-mg/L buffered ammonia standard.
4. Pipet 50.00 mL of the buffered ammonia standard into a clean 100-mL beaker. Add a stir bar.
5. Obtain a recent lot of Chlorine Solution Ampules, 50–70 mg/L, and note the actual free chlorine concentration for this lot.
6. Calculate the amount of Chlorine Solution to be added to the ammonia standard using the following equation:

$$\text{mL chlorine solution required} = \frac{455}{\text{free chlorine concentration}}$$

7. Open an ampule and use a glass Mohr pipet to add the calculated amount of Chlorine Solution slowly to the ammonia standard, while mixing at medium speed on a stir-plate.
8. Allow the monochloramine solution to mix for 1 minute after all Chlorine Solution is added.
9. Quantitatively transfer the monochloramine solution to a clean 100-mL Class A volumetric flask. Dilute to the mark with organic-free water, cap, and mix thoroughly. This is a nominal 4.5-mg/L (as Cl₂) monochloramine standard.
10. Use this standard within 1 hour of preparation. Analyze according to the Low Range Monochloramine procedure described above.
11. To adjust the calibration curve using the reading obtained with the 4.5-mg/L standard solution, press **OPTIONS>MORE** on the current program menu. Press **STANDARD ADJUST**.
12. Press **ON**. Press **ADJUST** to accept the displayed concentration (the value depends on the selected chemical form). If an alternate concentration is used, press the number in the box to enter the actual concentration, then press **OK**. Press **ADJUST**.

Summary of Method

In the presence of a cyanoferrate catalyst, monochloramine (NH₂Cl) in the sample reacts with a substituted phenol to form an intermediate monoimine compound. The intermediate couples with excess substituted phenol to form a green-colored indophenol, which is proportional to the amount of monochloramine present in the sample. Test results are measured at 655 nm.

Consumables and Replacement Items

Required Reagents

Description	Quantity/Test	Unit	Cat. No.
Monochlor F Reagent Pillows	1	50/pkg	28022-46

Required Apparatus

Description	Quantity/Test	Unit	Cat. No.
Adapter, for Multi-path and Pour-Thru cells	1	each	LZV585
Sample Cell, multi-path	1	6/pkg	59405-06

Optional Reagents

Description	Unit	Cat. No.
Buffer Powder Pillows pH 8.3	25/pkg	898-68
Chlorine Solution Voluette® Ampule 50–75 mg/L	16/pkg	14268-10
Nitrogen, Ammonia Standard Solution, 100-mg/L as NH ₃ -N	500 mL	24065-49
Organic-free Water	500-mL	26415-49
Rochelle Salt Solution	29 mL DB	1725-33

Optional Apparatus

Description	Cat. No.
Beaker, 100 mL	500-42H
Clippers	968-00
Flask, volumetric, Class A, 100-mL	14574-42
Pipet, Mohr, glass, 5-mL	20934-37
Pipet, volumetric, Class A, 2.00-mL	14515-36
Pipet, volumetric, Class A, 50.00-mL	14515-41
Stir Bar, octagonal	20953-52
Stirrer, magnetic	28812-00
Shears	23694-00



FOR TECHNICAL ASSISTANCE, PRICE INFORMATION AND ORDERING:

In the U.S.A. – Call toll-free 800-227-4224
Outside the U.S.A. – Contact the HACH office or distributor serving you.
On the Worldwide Web – www.hach.com; E-mail – techhelp@hach.com

HACH COMPANY
WORLD HEADQUARTERS
Telephone: (970) 669-3050
FAX: (970) 669-2932

Chloramine (Mono); Nitrogen, Free Ammonia

Method 10200

Indophenol Method¹

Powder Pillows

(0.01–0.50 mg/L NH₃-N; 0.04–4.50 mg/L Cl₂)

Scope and Application: For determining Free Ammonia and Monochloramine simultaneously in finished chloraminated water

¹ U.S. Patent 6,315,950



Test Preparation

Before starting the test:

For more accurate chloramine results, determine a reagent blank value for each new lot of reagent, using deionized water in place of the sample. Subtract the reagent blank value from the final results or perform a reagent blank adjust.

In bright light conditions (e.g. direct sunlight) it may be necessary to close the cell compartment with the protective cover during measurements.

Collect the following items:

Quantity

Free Ammonia Reagent Solution	1 drop
Monochlor F Reagent Pillows	2
Sample cell, 10-mL, 1-cm	2

Note: Reorder information for consumables and replacement items is on page 8.

Multi-path Cell

Method 10200

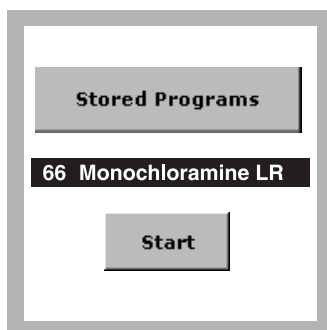

1. Select the Monochloramine test.

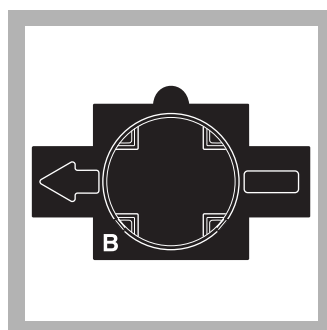

2. Insert Adapter B.

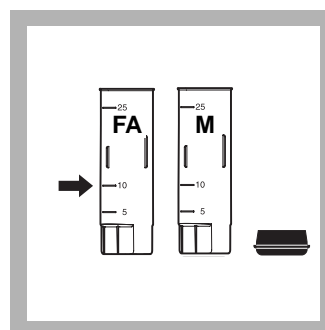

3. Fill two 1-cm cell to the 10-mL line with sample.

Label one cell "Free Ammonia" and one cell "Monochloramine".

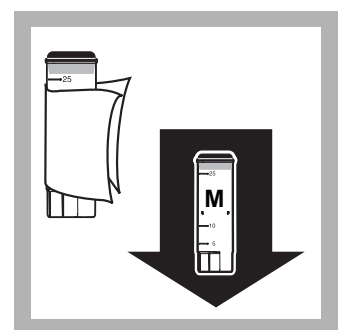

4. Wipe the monochloramine cell and insert it into the cell holder with the 1-cm (flat) path in line with the indicator arrow on the adapter.

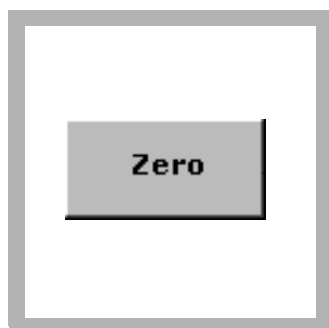

5. Press ZERO.
The display will show:
0.00 mg/L Cl₂

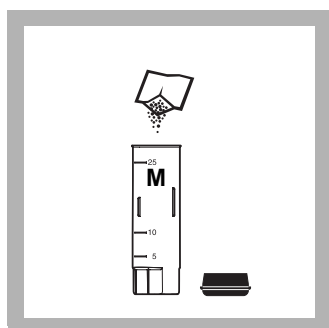

6. Remove the cell and add the contents of one pillow Monochlor-F to the sample for monochloramine measurement.

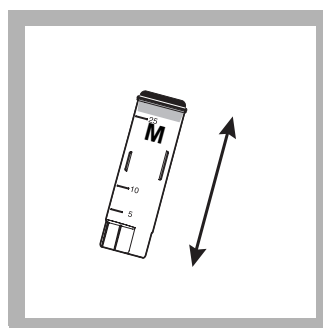

7. Cap and shake the cell about 20 seconds to dissolve.
A green color will develop if monochloramine is present.

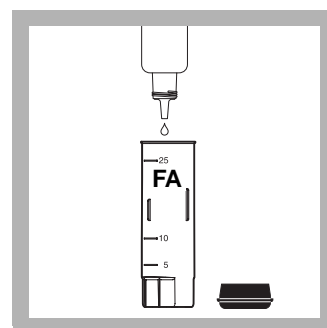

8. Add one drop of Free Ammonia Reagent Solution to the cell for Free Ammonia measurement.

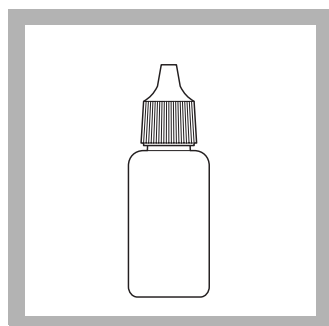

9. Cap the reagent bottle to maintain reagent performance and stability.

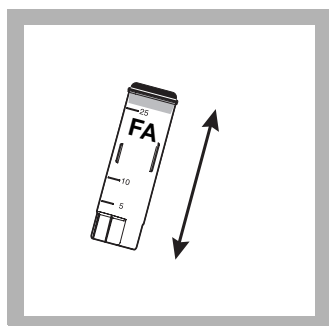

10. Cap and invert the Free Ammonia cell to mix.
If the sample becomes cloudy by the end of the reaction period, pretreat the sample and retest. See [Interferences on page 3](#).

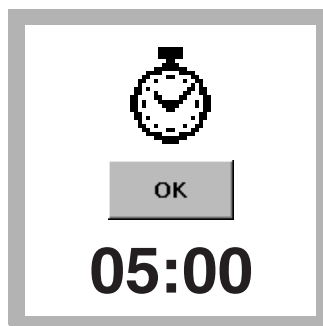

11. Press TIMER>OK.
A 5-minute reaction period will begin.
Color development time depends on sample temperature. For accurate results allow the full reaction period to occur. See [Table 1 on page 4](#).

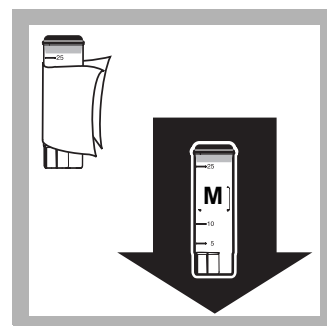

12. When the timer expires, wipe the Monochloramine cell and insert it into the cell holder with the 1-cm (flat) path in line with the indicator arrow on the adapter.

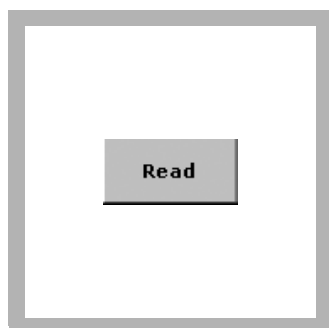

13. Press READ.
Results are in mg/L Monochloramine (as Cl₂).
Leave the cell in the instrument.

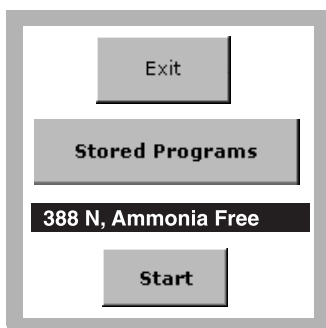

14. Select the Free Ammonia test.
If Display Lock is on, the display will show “Store Data?”. Press **YES** or **NO** and continue.

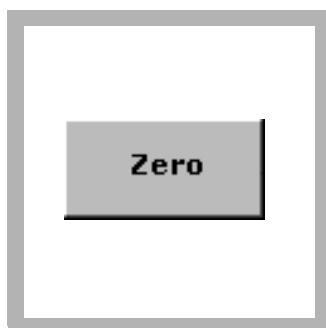

15. With the monochloramine sample still in the cell holder, press ZERO.
The display will show:
0.00 mg/L NH₃-N f
Remove the monochloramine cell.

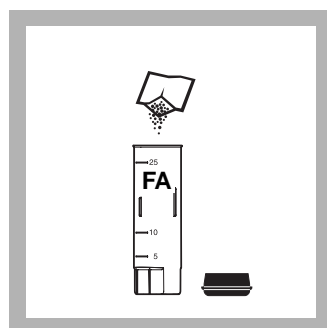

16. Add the contents of one pillow Monochlor F to the cell for the Free Ammonia measurement.
The reaction period in step 11 must be complete before adding the Monochlor F to the cell for Free Ammonia measurement.

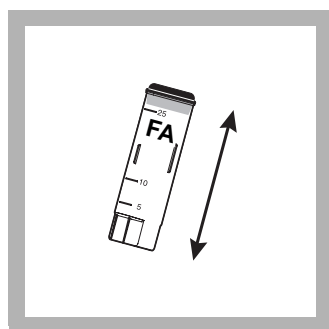

17. Cap and shake the cell about 20 seconds to dissolve the reagent.
A green color will form if monochloramine or ammonia is present.

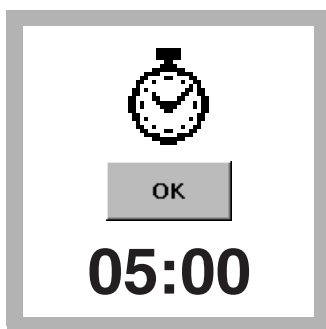

18. Press TIMER>OK.
A 5-minute reaction period will begin.
Samples colder than 18 °C will require additional time. See [Table 2 on page 4](#).

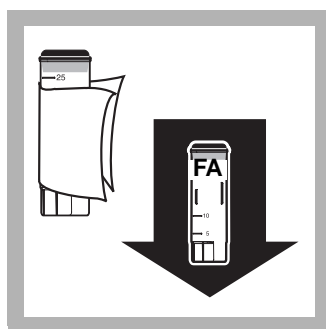

19. When the timer expires, insert the vial into the cell holder with the 1-cm (flat) path in line with the indicator arrow on the adapter.

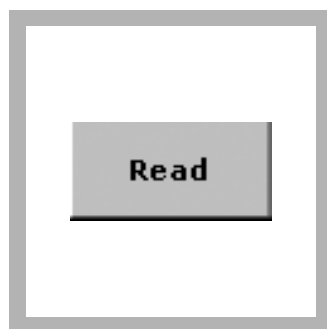

20. Press READ.
Results are in mg/L NH₃-N f.

Interferences

This method is intended for finished, chloraminated drinking water samples that have a measurable combined (total) chlorine disinfectant residual. Samples where the disinfectant residual has disappeared and samples which exhibit a chlorine demand may produce low ammonia test results. Blanks and ammonia standards analyzed without a disinfectant residual must be prepared using high quality, reagent grade water.

The following do not interfere in free ammonia determination at or below the stated concentration:

Table 1 Non-interfering Substances

Substance	Maximum Level Tested
Aluminum	0.2 mg/L
Chloride	1200 mg/L Cl
Copper	1 mg/L Cu
Iron	0.3 mg/L Fe
Manganese	0.05 mg/L Mn
Nitrate	10 mg/L NO ₃ -N
Nitrite	1 mg/L NO ₂ -N
Phosphate	2 mg/L o-PO ₄
Silica	100 mg/L SiO ₂
Sulfate	1600 ppm as CaCO ₃
Zinc	5 ppm Zn

Samples containing high levels of both Total Hardness and Alkalinity may become cloudy after the addition of the Free Ammonia Reagent Solution. If this occurs by the end of the first reaction period, the sample for Free Ammonia measurement must be pretreated as follows:

Note: The sample for Monochloramine measurement does not need pretreatment.

1. Measure 10 mL of sample into the cell for Free Ammonia measurement.
2. Add the contents of one Hardness Treatment Reagent Powder Pillow to the sample.
3. Cap the cell and invert until the reagent is dissolved.
4. Remove the cap.
5. Continue with the analysis at step 3 using the pretreated sample as the Free Ammonia cell.

Color Development Time

Test results are strongly influenced by sample temperature. **Both reaction periods in the procedure are the same and depend on the temperature of the sample.** The reaction periods indicated in the procedure are for a sample temperature of 18–20 °C (64–68 °F). Adjust both reaction periods according to [Table 2](#).

Table 2 Color Development Based on Sample Temperature

Sample Temperature		Development Time (minutes)
°C	°F	
5	41	10
7	45	9
9	47	8
10	50	8
12	54	7

Table 2 Color Development Based on Sample Temperature (continued)

Sample Temperature		Development Time (minutes)
°C	°F	
14	57	7
16	61	6
18	64	5
20	68	5
23	73	2.5
25	77	2
greater than 25	greater than 77	2

Sampling and Storage

Collect samples in clean glass bottles. Most reliable results are obtained when samples are analyzed as soon as possible after collection.

Accuracy Check (Monochloramine, Program 66)

Standard Solution Method

Important Note: Because of the strong buffer used in the preparation of this standard, it cannot be used for accuracy verification of the Free Ammonia test.

To check test accuracy, prepare the following 4.5-mg/L (as Cl₂) monochloramine standard immediately before use.

1. Add the contents of one Buffer Powder Pillow, pH 8.3 to about 50-mL of organic-free water in a clean 100-mL Class A volumetric flask. Swirl to dissolve the powder.
2. Using a Class A volumetric pipet, transfer 2.00 mL of Nitrogen, Ammonia Standard Solution, 100-mg/L as NH₃-N into the flask.
3. Dilute to volume with organic-free water, cap and mix thoroughly. This is a 2.00-mg/L buffered ammonia standard.
4. Pipet 50.00 mL of the buffered ammonia standard into a clean 100-mL beaker. Add a stir bar.
5. Obtain a recent lot of Chlorine Solution Ampules, 50–70 mg/L, and note the actual free chlorine concentration for this lot.
6. Calculate the amount of Chlorine Solution to be added to the ammonia standard using the following equation:

$$\text{mL chlorine solution required} = \frac{455}{\text{free chlorine concentration}}$$
7. Open an ampule and use a glass Mohr pipet to add the calculated amount of Chlorine Solution slowly to the ammonia standard, while mixing at medium speed on a stir-plate.
8. Allow the monochloramine solution to mix for 1 minute after all Chlorine Solution is added.

9. Quantitatively transfer the monochloramine solution to a clean 100-mL Class A volumetric flask. Dilute to the mark with organic-free water, cap, and mix thoroughly. This is a nominal 4.5-mg/L (as Cl₂) monochloramine standard.
10. Use this standard within 1 hour of preparation. Analyze according to the Low Range Monochloramine procedure described above.
11. To adjust the calibration curve using the reading obtained with the 4.5-mg/L standard solution, press **OPTIONS>MORE** on the current program menu. Press **STANDARD ADJUST**.
12. Press **ON**. Press **ADJUST** to accept the displayed concentration (the value depends on the selected chemical form). If an alternate concentration is used, press the number in the box to enter the actual concentration, then press **OK**. Press **ADJUST**.

Accuracy Check (Free Ammonia, Program 388)

Dilution water is required when testing a diluted sample and preparing standard solutions. Dilution water must be free of ammonia, chlorine and chlorine demand. A convenient source is a recirculating, deionizer system with carbon filtration which produces 18 megaohm-cm water.

Standard Additions Method

1. After reading test results, leave the sample cell (unspiked sample) in the instrument. Verify the chemical form.
2. Press **OPTIONS>MORE**. Press **STANDARD ADDITIONS**. A summary of the standard additions procedure will appear.
3. Press **OK** to accept the default values for standard concentrations, sample volume, and spike volumes. Press **EDIT** to change these values. After values are accepted, the unspiked sample reading will appear in the top row. See the user manual for more information.
4. Prepare three spiked samples. Measure 50 mL of sample into three 50-mL mixing cylinders.
5. Use the TenSette Pipet to add 0.3, 0.6, and 1.0 mL of Ammonium Nitrogen Standard, 10 mg/L as NH₃-N to the three samples. Mix well.
6. Analyze each spiked sample starting with the 0.3 mL sample spike. Accept each standard additions reading by pressing **READ**. Each addition should reflect approximately 100% recovery. Follow all steps in Method 10200.
7. After completing the sequence, press **GRAPH** to view the best-fit line through the standard additions data points, accounting for matrix interferences. Press **IDEAL LINE** to view the relationship between the sample spikes and the “Ideal Line” of 100% recovery.

Standard Solution Method

1. Prepare a 0.20 mg/L ammonia nitrogen standard by diluting 2.00 mL of the Ammonia Nitrogen Standard Solution, 10 mg/L, to 100 mL with dilution water. Or, using the TenSette Pipet, prepare a 0.20 mg/L ammonia nitrogen standard by diluting 0.4 mL of a Ammonia Nitrogen Voluette Standard Solution, 50 mg/L as NH₃-N, to 100 mL with dilution water. Analyze the Standard Solution, following all steps in Method 10200.
2. To adjust the calibration curve using the reading obtained with the standard solution, press **OPTIONS>MORE** on the current program menu. Press **STANDARD ADJUST**.
3. Press **ON**. Press **ADJUST** to accept the displayed concentration. If an alternate concentration is used, press the number in the box to enter the actual concentration, then press **OK**. Press **ADJUST**.

Summary of Method

Monochloramine (NH₂Cl) and free ammonia (NH₃ and NH₄⁺) can exist in the same water sample. Added hypochlorite combines with free ammonia to form more monochloramine. In the presence of a cyanoferrate catalyst, monochloramine in the sample reacts with a substituted phenol to form an intermediate monoimine compound. The intermediate couples with excess substituted phenol to form a green-colored indophenol, which is proportional to the amount of monochloramine present in the sample. Free ammonia is determined by comparing the color intensities, with and without added hypochlorite. Test results are measured at 655 nm.

Consumables and Replacement Items

Required Reagents

Description	Quantity/Test	Unit	Cat. No.
Free Ammonia Reagent Set (50 tests), includes: (1) 28022-99, (1) 28773-36	—	—	28797-00
Free Ammonia Reagent Solution	1 drop	4 mL SCDB	28773-36
Monochlor F Reagent Pillows	2	100/pkg	28022-99

Required Apparatus

Description	Quantity/Test	Unit	Cat. No.
Sample Cell, multi-path	1	6/pkg	59405-06

Recommended Standards and Reagents

Description	Unit	Cat. No.
Buffer, pH 8.3 Powder Pillows	25/pkg	898-68
Chlorine Solution Voluette® Ampule	16/pkg	14268-10
Hardness Treatment Reagent Pillows (1 per test)	50/pkg	28823-46
Nitrogen Ammonia Standard Solution, 10 mg/L as NH ₃ -N	500 mL	153-49
Nitrogen Ammonia Standard Ampule, 50 mg/L as NH ₃ -N, 10 mL	16/pkg	14791-10
Nitrogen, Ammonia Standard Solution, 100-mg/L as NH ₃ -N	500 mL	24065-49
Water, Organic-free water	500-mL	26415-49

Recommended Apparatus

Description	Unit	Cat. No.
Ampule Breaker Kit	each	21968-00
Beaker, 100 mL, Polypropylene	each	1080-42
Beaker, 100 mL, Glass	each	500-42H
Cylinder, 50 mL, mixing	each	20886-41
Flask, volumetric, Class A, 100 mL	each	14574-42
Pipet Filler, safety bulb	each	14651-00
Pipet, TenSette®, 0.1 to 1.0 mL	each	19700-01
Pipet Tips, for TenSette Pipet 19700-01	50/pkg	21856-96
Pipet, Mohr, Glass, 10 mL	each	20934-38
Pipet, volumetric, Class A, 2.0 mL	each	14515-36
Pipet, volumetric, Class A, 50.00 mL	each	14515-41
Scissors	each	28831-00
Stir Bar, octagonal	each	20953-52
Stirrer, magnetic	each	28812-00
Thermometer, –10 to 110 °C	each	1877-01
Wipers, Disposable Kimwipes®, 30 x 30 cm, 280/box	box	20970-00



FOR TECHNICAL ASSISTANCE, PRICE INFORMATION AND ORDERING:
 In the U.S.A. – Call toll-free 800-227-4224
 Outside the U.S.A. – Contact the HACH office or distributor serving you.
 On the Worldwide Web – www.hach.com; E-mail – techhelp@hach.com

HACH COMPANY
 WORLD HEADQUARTERS
 Telephone: (970) 669-3050
 FAX: (970) 669-2932

Scope and Application: For water and wastewater



Test Preparation

Before starting the test:

Filter turbid samples with moderately rapid filter paper and a funnel before analysis.

Both the sample and the blank will contain mercury (D009) at a concentration regulated as a hazardous waste by the Federal RCRA. Do not pour these solutions down the drain.

Refer to the MSDS sheet for safe handling and disposal of hazardous waste.

Collect the following items:

Quantity

Ferric Ion Solution	1 mL
Mercuric Thiocyanate Solution	2 mL
Deionized Water	10 mL
Sample Cells, 1-inch square, 10-mL	2
Pipet, TenSette®, 0.1 to 1.0 mL	1
Pipet tips for 0.1 to 1.0 mL TenSette pipet	2

Note: Reorder information for consumables and replacement items is on page 4.

Mercuric Thiocyanate

Method 8113



1. Press **STORED PROGRAMS**.

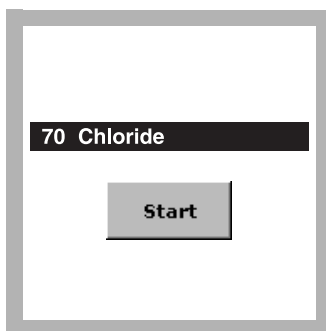

2. Select the test.

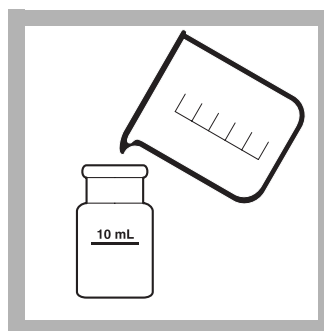

3. **Prepared Sample:**
Fill a square sample cell with 10 mL of sample.

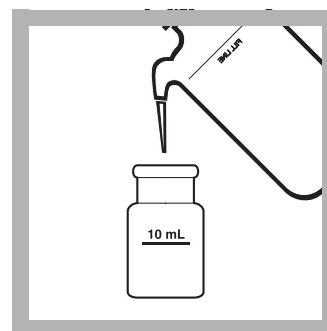

4. **Blank Preparation:**
Fill another square sample cell with 10 mL of deionized water.

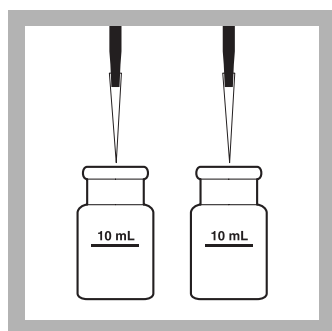

5. Pipet 0.8 mL of Mercuric Thiocyanate Solution into each sample cell.

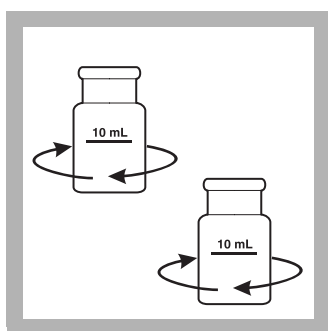

6. Swirl to mix.

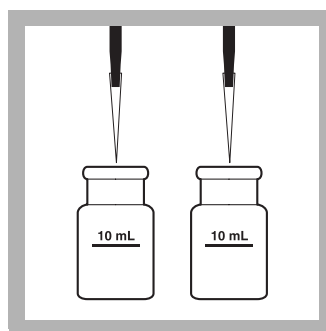

7. Pipet 0.4 mL of Ferric Ion Solution into each sample cell.

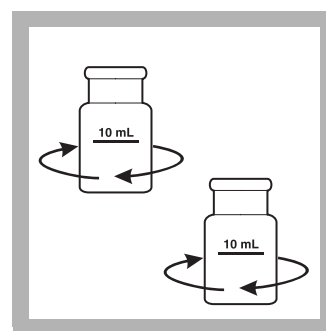

8. Swirl to mix. An orange color will develop if chloride is present.

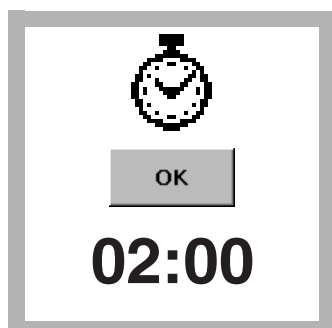

9. Press **TIMER>OK**.
A two-minute reaction time will begin.

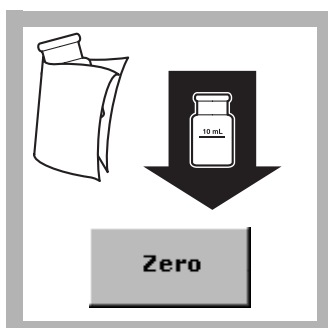

10. Within five minutes after the timer expires, wipe the blank and insert it into the cell holder with the fill line facing right.

Press **ZERO**.

The display will show:

0.0 mg/L Cl⁻



11. Wipe the prepared sample and insert it into the cell holder with the fill line facing right.

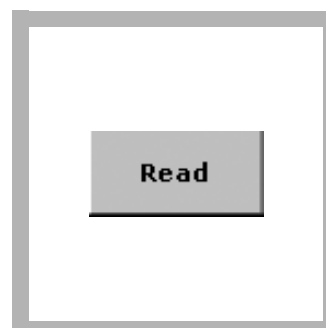

12. Press **READ**.
Results are in mg/L Cl⁻.

Interferences

Table 1 Interfering Substances and Levels

Interfering Substance	Interference Levels and Treatments
Extreme pH	Should be about pH 2 after adding reagents. If the sample is strongly acidic or alkaline, adjust a portion of sample before testing to a pH of about 7. Use either 5.0 N Sodium Hydroxide Standard Solution ¹ or a 1:5 dilution of perchloric acid. Use pH paper ; most pH electrodes will contaminate the sample with chloride.

¹ See [Optional Reagents and Apparatus on page 4](#).

Sample Collection, Storage, and Preservation

Collect samples in glass or plastic containers. Samples can be stored for at least 28 days at room temperature.

Accuracy Check

Standard Additions Method (Sample Spike)

1. After reading test results, leave the sample cell (unspiked sample) in the instrument.
2. Press **OPTIONS>MORE**. Press **STANDARD ADDITIONS**. A summary of the standard additions procedure will appear.
3. Press **OK** to accept the default values for standard concentration, sample volume, and spike volumes. Press **EDIT** to change these values. After values are accepted, the unspiked sample reading will appear in the top row. See the user manual for more information.
4. Prepare three sample spikes. Fill three 50 mL mixing cylinders with 50 mL of sample. Use the TenSette® Pipet to add 0.1 mL, 0.2 mL and 0.3 mL of 1000-mg/L Chloride Standard Solution, respectively, to the cylinders and mix each thoroughly.
5. Analyze a 10 mL portion of each sample spike as described in the procedure above, starting with the 0.1 mL sample spike. Accept each standard additions reading by pressing **READ**. Each addition should reflect approximately 100% recovery.
6. After completing the sequence, press **GRAPH** to view the best-fit line through the standard additions data points, accounting for matrix interferences. Press **IDEAL LINE** to view relationships between the sample spikes and the "Ideal Line" of 100% recovery.

Standard Solution Method

Prepare a 20.0-mg/L chloride standard solution as follows:

1. Using Class A glassware, pipet 10.00 mL of Chloride Standard Solution*, 1000-mg/L, into a 500-mL volumetric flask.
2. Dilute to the mark with deionized water. Perform the chloride procedure as described above.
3. To adjust the calibration curve using the reading obtained with the standard solution, press **OPTIONS>MORE** on the current program menu. Press **STANDARD ADJUST**.
4. Press **ON**. Press **ADJUST** to accept the displayed concentration. If an alternate concentration is used, press the number in the box to enter the actual concentration, then press **OK**. Press **ADJUST**.

*See [Optional Reagents and Apparatus on page 4](#).

Chloride (0.1 to 25.0 mg/L Cl⁻)

Summary of Method

Chloride in the sample reacts with mercuric thiocyanate to form mercuric chloride and liberate thiocyanate ion. Thiocyanate ions react with the ferric ions to form an orange ferric thiocyanate complex. The amount of this complex is proportional to the chloride concentration. Test results are measured at 455 nm.

Consumables and Replacement Items

Required Reagents

Description	Quantity/Test	Unit	Cat. No.
Chloride Reagent Set (50 Tests) ¹ , includes:	—	each	23198-00
(1) Ferric Ion Solution	1 mL	100 mL	22122-42
(1) Mercuric Thiocyanate Solution	2 mL	200 mL	22121-29
Water, deionized	10 mL	4 L	272-56

¹ 50 tests equals 25 samples and 25 blanks.

Required Apparatus

Description	Quantity/Test	Unit	Cat. No.
Sample Cells, 1-inch square, 10-mL	2	2/pkg	24954-02
Pipet, TenSette®, 0.1 to 1.0 mL	1	each	19700-01
Pipet Tips, for TenSette Pipet 19700-01	varies	50/pkg	21856-96

Recommended Standards

Description	Unit	Cat. No.
Chloride Standard Solution, 1000-mg/L Cl ⁻	500 mL	183-49

Optional Reagents and Apparatus

Description	Unit	Cat. No.
Chloride Standard Solution, 2-mL Voluette® Ampule, 12,500-mg/L Cl ⁻	20/pkg	14250-20
Cylinders, mixing	50 mL	1896-41
Filter Paper, funnel	100/pkg	692-57
Funnel, poly	75 mm	1083-68
Perchloric Acid, ACS	—	757-65
pH Paper	—	391-33
Pipet Tips, for TenSette Pipet 19700-01	1000/pkg	21856-28
Pipet, volumetric, Class A	1 mL	14515-35
Pipet, volumetric, Class A	0.5 mL	14515-37
Pipet Filler, safety bulb	—	14651-00
Sodium Hydroxide Standard Solution, 50 mL SCDB	50 mL	2450-26



FOR TECHNICAL ASSISTANCE, PRICE INFORMATION AND ORDERING:
In the U.S.A. – Call toll-free 800-227-4224
Outside the U.S.A. – Contact the HACH office or distributor serving you.
On the Worldwide Web – www.hach.com; E-mail – techhelp@hach.com

HACH COMPANY
WORLD HEADQUARTERS
Telephone: (970) 669-3050
FAX: (970) 669-2932

Chlorine Dioxide

Method 8138

Direct Reading Method
HR (5 to 1000 mg/L)

Scope and Application: For water and wastewater



Test Preparation

Before starting the test:

Chlorine dioxide is unstable and volatile. Analyze samples immediately.

Collect the following items:

Quantity

Water, deionized	10 mL
Sample cell, 1-inch square glass, 10-mL	2

Note: Reorder information for consumables and replacement items is on page 2.

Direct Reading

Method 8138



1. Press **STORED PROGRAM**.

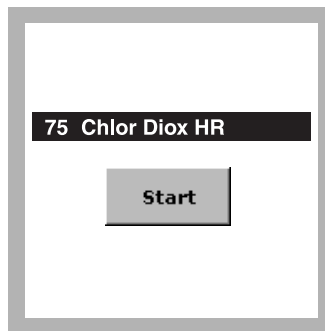

2. Select the test.

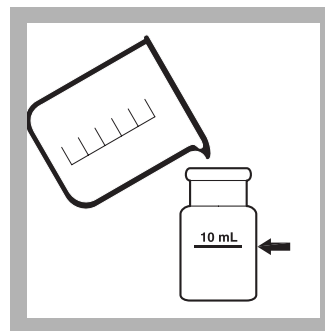

3. **Blank Preparation:**
Fill a square sample cell to the 10-mL mark with deionized water.



4. Wipe the blank and insert it into the cell holder with the fill line facing right.

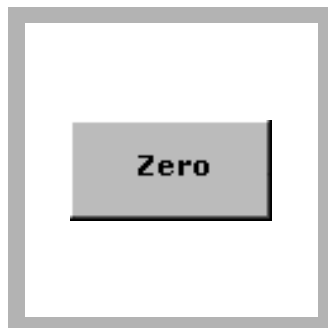

5. Press **ZERO**.
The display will show:
0 mg/L ClO₂

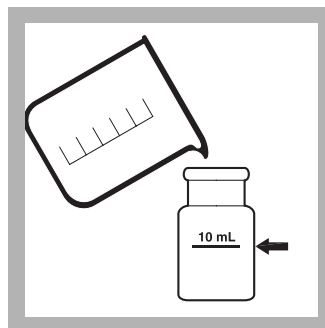

6. **Prepared Sample:**
Fill a second square sample cell to the 10-mL mark with sample.



7. Wipe the prepared sample and insert it into the cell holder with the fill line facing right.



8. Press **READ**.
Results are in mg/L ClO₂.

Sample Collection, Storage, and Preservation

Analyze samples for chlorine dioxide immediately after collection. Chlorine dioxide is a strong oxidizing agent and is unstable in natural waters. It reacts rapidly with various inorganic compounds, but oxidizes organic compounds more slowly. Many factors, including reactant concentrations, sunlight, pH, temperature, and salinity influence decomposition of chlorine dioxide in water.

Avoid plastic containers since these may have a large chlorine dioxide demand. Pretreat glass sample containers to remove any chlorine or chlorine dioxide demand by soaking in a dilute bleach solution (1 mL commercial bleach to 1 liter of deionized water) for at least one hour. Rinse thoroughly with deionized or distilled water. If sample containers are rinsed thoroughly with deionized or distilled water after use, only occasional pretreatment is necessary.

A common error in testing for chlorine dioxide is not obtaining a representative sample. If sampling from a tap, let the water flow for at least 5 minutes to ensure a representative sample. Let the container overflow with the sample several times, then cap the sample containers so there is no headspace (air) above the sample. If sampling with a sample cell, rinse the cell several times with the sample, then carefully fill to the 10-mL mark. Perform the chlorine dioxide analysis immediately.

Accuracy Check

Standard Solution Method

Preparing chlorine dioxide standards is difficult and dangerous. In addition, these standards are both explosive and volatile! Only a trained chemist should prepare the standards using appropriate safety equipment and precautions. The manufacturer does not recommend preparation of chlorine dioxide standards. If independent standard preparation is required, please see the instructions in *Standard Methods for the Examination of Water and Wastewater*, 20th ed., under the headings "Stock chlorine dioxide solution" and "Standard chlorine dioxide solution" (pp 4–74 and 4–75). Prepare a 500-mg/L chlorine dioxide standard.

Summary of Method

Chlorine dioxide, a yellow gas, can be measured directly in a water solution. Test results are measured at 445 nm.

Consumables and Replacement Items

Required Reagents

Description	Quantity/Test	Unit	Cat. No.
Water, deionized	10 mL	4 L	272-56

Required Apparatus

Description	Quantity/Test	Unit	Cat. No.
Sample Cells, 1-inch square, glass, 10 mL, matched pair	2	2/pkg	24954-02



FOR TECHNICAL ASSISTANCE, PRICE INFORMATION AND ORDERING:
In the U.S.A. – Call toll-free 800-227-4224
Outside the U.S.A. – Contact the HACH office or distributor serving you.
On the Worldwide Web – www.hach.com; E-mail – techhelp@hach.com

HACH COMPANY
WORLD HEADQUARTERS
Telephone: (970) 669-3050
FAX: (970) 669-2932

Chlorine Dioxide

Method 8065

Chlorophenol Red Method¹
LR (0.01 to 1.00 mg/L)

Scope and Application: For water and wastewater

¹ Adapted from Harp, Klein, and Schoonover, *Jour. Amer. Water Works Assn.*, 73 387–388 (1981).



Test Preparation

Before starting the test:

Chlorine dioxide is unstable and volatile. Analyze samples immediately.

For most accurate results, analyze each portion of sample at the same temperature.

A TenSette® Pipet may be used to dispense Chlorine Dioxide Reagent 1 and Chlorine Dioxide Reagent 3

Collect the following items:

Quantity

Chlorine Dioxide Reagent 1	2 mL
Chlorine Dioxide Reagent 2	2 mL
Chlorine Dioxide Reagent 3	2 mL
Dechlorinating Reagent Pillows	1
Cylinder, graduated mixing, 50 mL	2
Pipet, volumetric, Class A, 1 mL	3
Pipet Filler, with safety bulb	1
Sample Cells, 1-inch square, 10-mL	2

Note: Reorder information for consumables and replacement items is on page 4.

Powder Pillows

Method 8065



1. Press **Stored Programs**.

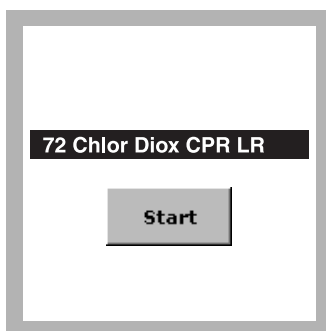

2. Select the test.

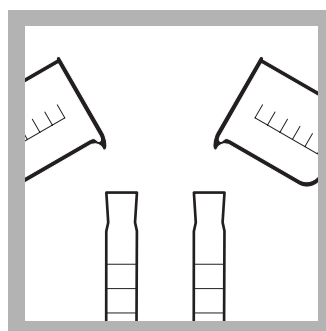

3. Fill two 50-mL mixing cylinders to the 50-mL mark with sample.

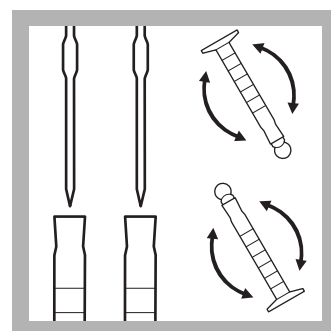

4. Use a volumetric pipet and pipet filler to add 1.0 mL of Chlorine Dioxide Reagent 1 to each cylinder. Stopper. Invert several times to mix.

Chlorine Dioxide LR (0.01 to 1.00 mg/L)

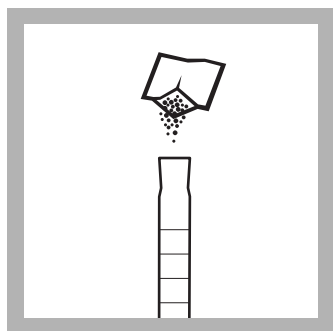

5. Blank Preparation: Add the contents of one Dechlorinating Reagent Powder Pillow to one cylinder. (This is the blank).

Stopper and invert several times until dissolved.

The second cylinder, which does **not** receive dechlorinating reagent, is the prepared sample.

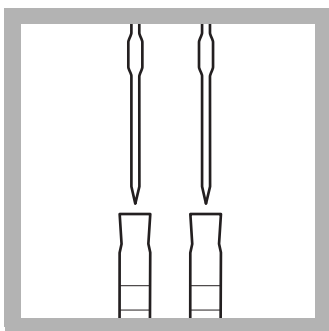

6. Use a volumetric pipet to add exactly 1.00 mL of Chlorine Dioxide Reagent 2 to each cylinder. Stopper.

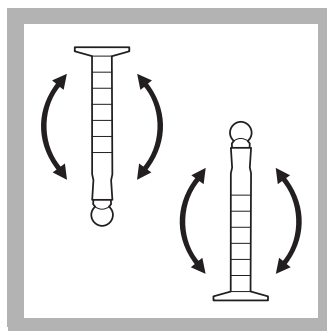

7. Invert several times to mix.

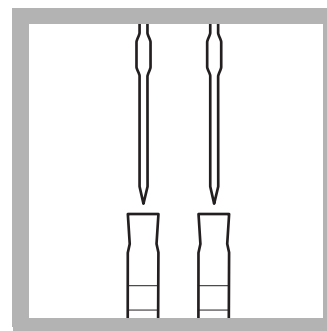

8. Use a volumetric pipet and pipet filler to add 1.0 mL of Chlorine Dioxide Reagent 3 to each cylinder. Stopper.

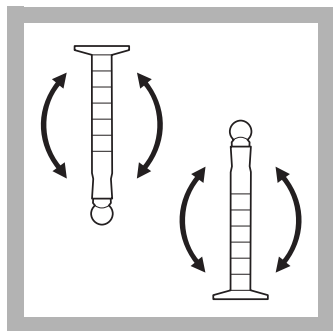

9. Invert several times to mix.

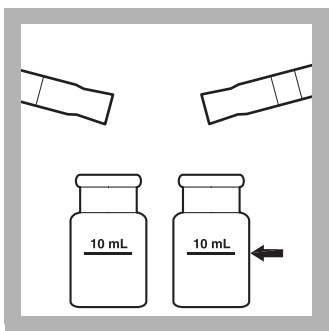

10. Pour 10 mL from each cylinder into square sample cells.

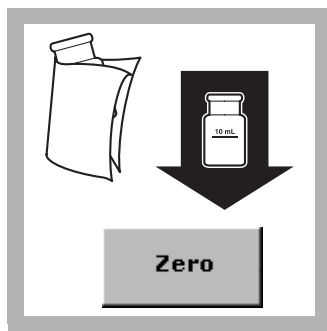

11. Wipe the blank and insert it into the cell holder with the fill line facing right.

Press **ZERO**.

The display will show:
0.00 mg/L ClO₂

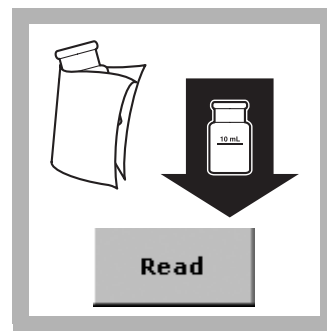

12. Wipe the prepared sample and insert it into the cell holder with the fill line facing right.

Press **READ**.

Results are in mg/L ClO₂.

Interferences

Table 1 Interfering Substances and Levels

Interfering Substance	Interference Levels and Treatments
Highly acidic or alkaline water	May require 2.0 mL each of Chlorine Dioxide Reagent 1 and Chlorine Dioxide Reagent 3 instead of 1.0 mL
ClO ⁻	Greater than 5.5 mg/L
ClO ₂ ⁻	Greater than 6 mg/L
ClO ₃ ⁻	Greater than 6 mg/L
CrO ₄ ²⁻	Greater than 3.6 mg/L
Fe ³⁺	Greater than 5 mg/L
Hardness	Greater than 1000 mg/L
Ozone	Greater than 0.5 mg/L
Turbidity	Greater than 1000 NTU

Sample Collection, Storage, and Preservation

Analyze samples for chlorine dioxide immediately after collection. Chlorine dioxide is a strong oxidizing agent and is unstable in natural waters. It reacts rapidly with various inorganic compounds, but oxidizes organic compounds more slowly. Many factors, including reactant concentrations, sunlight, pH, temperature, and salinity influence decomposition of chlorine dioxide in water.

Avoid plastic containers since these may have a large chlorine dioxide demand. Pretreat glass sample containers to remove any chlorine or chlorine dioxide demand by soaking in a dilute bleach solution (1 mL commercial bleach to 1 liter of deionized water) for at least one hour. Rinse thoroughly with deionized or distilled water. If sample containers are rinsed thoroughly with deionized or distilled water after use, only occasional pretreatment is necessary.

A common error in testing for chlorine dioxide is not obtaining a representative sample. If sampling from a tap, let the water flow for at least 5 minutes to ensure a representative sample. Let the container overflow with the sample several times, then cap the sample containers so there is no headspace (air) above the sample.

Accuracy Check

Standard Solution Method

Preparing chlorine dioxide standards is difficult and dangerous. In addition, these standards are both explosive and volatile! Only a trained chemist should prepare the standards using appropriate safety equipment and precautions. The Manufacturer does not recommend preparation of chlorine dioxide standards. If independent standard preparation is required, please see the instructions in *Standard Methods for the Examination of Water and Wastewater*, 20th ed., under the headings "Stock chlorine dioxide solution" and "Standard chlorine dioxide solution" (pp 4–74 and 4–75). Prepare a 0.50-mg/L chlorine dioxide standard.

Summary of Method

Chlorine Dioxide (ClO₂) is determined by its combination with chlorophenol red at pH 5.2 to form a colorless complex. The net effect is bleaching of the color in an amount proportional to the chlorine dioxide concentration. The method is specific for ClO₂ and is unreactive to other active chlorine or moderate oxidizing compounds. Test results are measured at 575 nm.

Chlorine Dioxide LR (0.01 to 1.00 mg/L)

Consumables and Replacement Items

Required Reagents

Description	Quantity/Test	Unit	Cat. No.
Chlorine Dioxide Reagent Set (100 Tests), includes:	—	each	22423-00
(2) Chlorine Dioxide Reagent 1	2 mL	100 mL	20700-42
(2) Chlorine Dioxide Reagent 2	2 mL	100 mL	20701-42
(2) Chlorine Dioxide Reagent 3	2 mL	100 mL	20702-42
(1) Dechlorinating Reagent Powder Pillows	1	100/pkg	14363-69

Required Apparatus

Description	Quantity/Test	Unit	Cat. No.
Cylinder, graduated mixing, 50-mL	2	each	1896-41
Pipet, volumetric, Class A, 1.00-mL	3	each	14515-35
Pipet Filler, safety bulb	1	each	14651-00
Sample Cells, 1-inch square, 10 mL, matched pair	2	2/pkg	24954-02

Optional Reagents and Apparatus

Description	Unit	Cat. No.
Pipet, TenSette®, 0.1 to 1.0 mL	each	19700-01
Pipet Tips, for TenSette Pipet 19700-01	50/pkg	21856-96



FOR TECHNICAL ASSISTANCE, PRICE INFORMATION AND ORDERING:
In the U.S.A. – Call toll-free 800-227-4224
Outside the U.S.A. – Contact the HACH office or distributor serving you.
On the Worldwide Web – www.hach.com; E-mail – techhelp@hach.com

HACH COMPANY
WORLD HEADQUARTERS
Telephone: (970) 669-3050
FAX: (970) 669-2932

Chlorine Dioxide

Amaranth Method¹
(20 to 500 µg/L)

Scope and Application: For water, drinking water

¹ This method is under license of Elf Atofina. Reagent sets for this method are only available in Europe.



Test Preparation

Before starting the test:

Chlorine dioxide is unstable and volatile. Analyze samples immediately. See [Sample Collection, Storage, and Preservation on page 3](#).

For most accurate results, analyze each portion of sample at the same temperature.

A TenSette® pipet may be used to dispense Chlorine Dioxide Reagent A.

Collect the following items:

Quantity

Chlorine Dioxide Reagent Set	1
Volumetric Flask, 25-mL plastic	2
Syringe, 1-mL with needle	1
Sample cell, 1-inch square glass, 10-mL	2

Note: Reorder information for consumables and replacement items is on [page 4](#).

Note: For best precision, measurement of the reagent with a volumetric pipet or high precision pipettor is recommended.

Amaranth Method



1. Press **STORED PROGRAMS**.

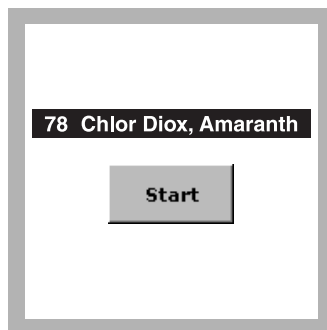

2. Select the test.

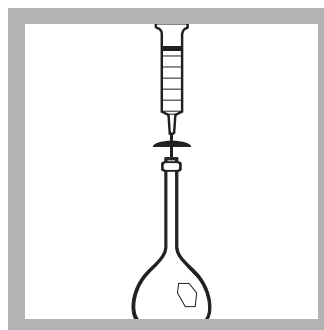

3. **Blank Preparation:** Using the syringe and needle provided, add 1.0 mL of Chlorine Dioxide Reagent A into a 25-mL volumetric flask.



4. Fill the volumetric flask to the mark with deionized water. Stopper. Invert at least 7 times to mix.

Chlorine Dioxide (20 to 500 µg/L)

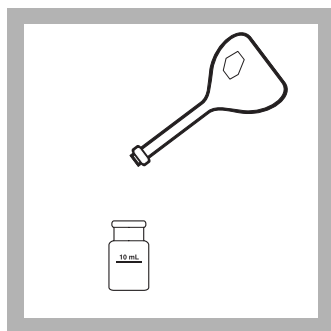

5. Pour 10 mL from the volumetric flask into a 10 mL sample cell.

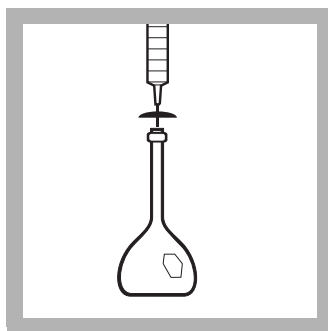

6. **Prepared Sample:** Add 1.0 mL of Chlorine Dioxide Reagent A into a second 25-mL volumetric flask.

Use a volumetric pipet and pipet filler or a TenSette Pipet to add this reagent.

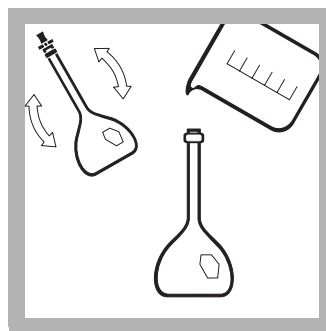

7. Fill the second volumetric flask to the mark with the sample. Stopper. Invert at least 7 times to mix.

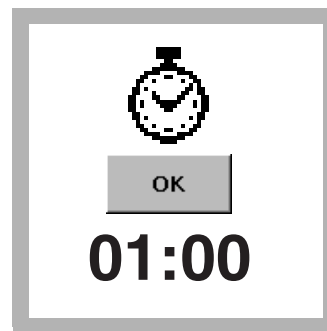

8. Press **TIMER>OK**. A 1-minute reaction period will begin.

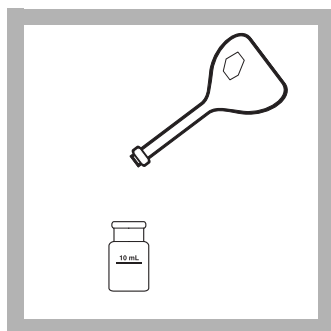

9. **Prepared Sample:** Pour 10 mL from the second volumetric flask into a second sample cell.

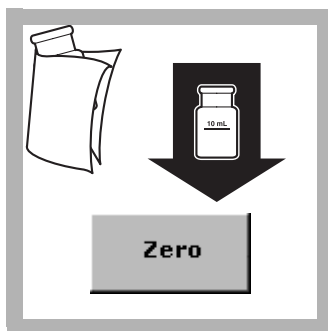

10. Wipe the blank and insert it into the cell holder with the fill line facing right. Press **ZERO**.

The display will show:

0 µg/L ClO₂



11. When the timer expires, wipe the prepared sample and insert it into the cell holder with the fill line facing right.

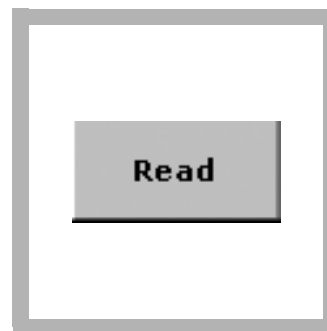

12. Press **READ**.
Results are in µg/L ClO₂.

Interferences

Table 1 Interfering Substances and Levels

Interfering Substance	Interference Levels and Treatments
ClO ⁻	Greater than 2.0 mg/L
ClO ₂ ⁻	Greater than 2.0 mg/L
ClO ₃ ⁻	Greater than 2.0 mg/L
CrO ₄ ²⁻	Greater than 0.2 mg/L
Fe ³⁺	Greater than 0.5 mg/L
Hardness	Greater than 1000 mg/L
Ozone	Greater than 0.5 mg/L
Turbidity	Greater than 1000 NTU

Sample Collection, Storage, and Preservation

Analyze samples for chlorine dioxide immediately after collection. Chlorine dioxide is a strong oxidizing agent and is unstable in natural waters. It reacts rapidly with various inorganic compounds, but oxidizes organic compounds more slowly. Many factors, including reactant concentrations, sunlight, pH, temperature, and salinity influence decomposition of chlorine dioxide in water.

Avoid plastic containers since these may have a large chlorine dioxide demand. Pretreat glass sample containers to remove any chlorine or chlorine dioxide demand by soaking in a dilute bleach solution (1 mL commercial bleach to 1 liter of deionized water) for at least one hour. Rinse thoroughly with deionized or distilled water. If sample containers are rinsed thoroughly with deionized or distilled water after use, only occasional pretreatment is necessary.

A common error in testing for chlorine dioxide is not obtaining a representative sample. If sampling from a tap, let the water flow for at least 5 minutes to ensure a representative sample. Let the container overflow with the sample several times, then cap the sample containers so there is no headspace (air) above the sample.

Accuracy Check

Standard Solution Method

Preparing chlorine dioxide standards is difficult and dangerous. In addition, these standards are both explosive and volatile! Only a trained chemist should prepare the standards using appropriate safety equipment and precautions. The manufacturer does not recommend preparation of chlorine dioxide standards. If independent standard preparation is required, please see the instructions in *Standard Methods for the Examination of Water and Wastewater*, 20th ed., under the headings "Stock chlorine dioxide solution" and "Standard chlorine dioxide solution" (pp 4–74 and 4–75). Prepare a 0.25-mg/L (250-µg/L) chlorine dioxide standard.

Summary of Method

Chlorine dioxide (ClO₂) is determined by its combination with Amaranth. Color intensity decreases as the level of chlorine dioxide increase. Test results are measured at 521 nm.

Chlorine Dioxide (20 to 500 µg/L)

Consumables and Replacement Items

Required Reagents

Description	Quantity/Test	Unit	Cat. No.
Chlorine Dioxide Reagent Set (100 Tests) ¹	1	100/pkg	LYW 240

¹ Available only in Europe.

Required Apparatus

Description	Quantity/Test	Unit	Cat. No.
Chlorine Dioxide Tool Set, includes:	—	each	LZC 140
(2) Flask, volumetric, plastic, 25-mL	2	each	—
(1) Syringe, 1-mL, with needle	1	each	—
Sample Cells, 1-inch square glass, 10-mL	2	2/pkg	24954-02

Optional Reagents and Apparatus

Description	Unit	Cat. No.
Pipet, TenSette®, 0.1 to 1.0 mL	each	19700-01
Pipet Tips, for TenSette Pipet 19700-01	50/pkg	28156-96
Pipet Filler, safety bulb	each	each
Pipet, volumetric, Class A, 1.00-mL	each	each



FOR TECHNICAL ASSISTANCE, PRICE INFORMATION AND ORDERING:
In the U.S.A. – Call toll-free 800-227-4224
Outside the U.S.A. – Contact the HACH office or distributor serving you.
On the Worldwide Web – www.hach.com; E-mail – techhelp@hach.com

HACH COMPANY
WORLD HEADQUARTERS
Telephone: (970) 669-3050
FAX: (970) 669-2932

Chlorine Dioxide

★ Method 10126

DPD Method¹

Powder Pillows and AccuVac[®] Ampuls

(0.04 to 5.00 mg/L)

Scope and Application: For water and wastewater. USEPA accepted for reporting for drinking water analysis.²

¹ Adapted from *Standard Methods for the Examination of Water and Wastewater*.

² Procedure is equivalent to *Standard Methods, 18 ed., 4500 ClO₂ D*.



Test Preparation

Before starting the test:

Analyze samples immediately because chlorine dioxide is unstable and volatile. See [Sample Collection, Storage, and Preservation on page 5](#).

For more accurate results, determine a reagent blank value for each new lot of reagent. Follow the procedure using chlorine-free deionized water instead of the sample. Subtract the reagent blank value from the final results or perform a reagent blank adjust.

After adding the DPD Free Chlorine Powder Pillow to the sample, a pink color will develop if chlorine dioxide is present.

If the chlorine dioxide concentration in the sample exceeds the upper limit of the test, the color may fade or the sample may turn yellow. Dilute the sample with high quality water that is chlorine demand-free, and repeat the test. Some loss of chlorine dioxide may occur. Multiply the result by the appropriate dilution factor.

Collect the following items:

Quantity

	Quantity
Powder Pillow Test:	
DPD Free Chlorine powder pillow, 10-mL	1
Glycine Reagent	4 drops
Sample cells, 1-inch square, 10-mL	2
Stopper for 18 mm tube	2
AccuVac Test:	
DPD Free Chlorine Reagent AccuVac [®] Ampuls	1
Glycine Reagent	16 drops
Beaker, 50-mL	1
Sample Cell, 10-mL	1
Stopper for 18 mm tube	1

Note: Reorder information for consumables and replacement items is on [page 7](#).

Powder Pillows

Method 10126



1. Press **STORED PROGRAMS**.

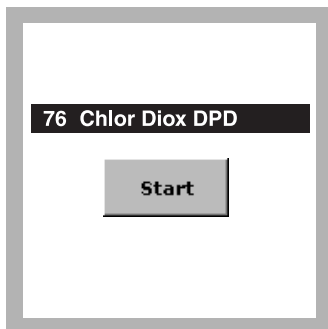

2. Select the test.

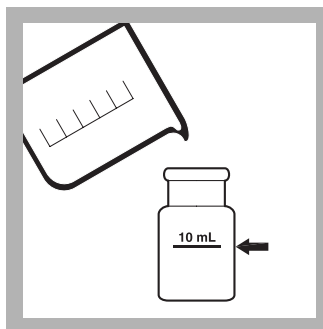

3. **Blank Preparation:**
Fill a square sample cell with 10 mL of sample and stopper.

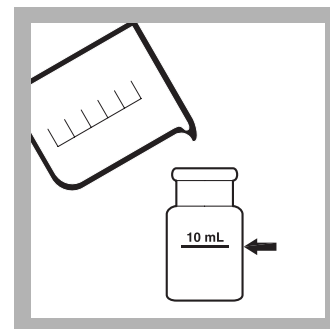

4. **Prepared Sample:**
Fill a second square sample cell with 10 mL of sample and stopper.



5. Wipe the blank and insert it into the cell holder with the fill line facing right.

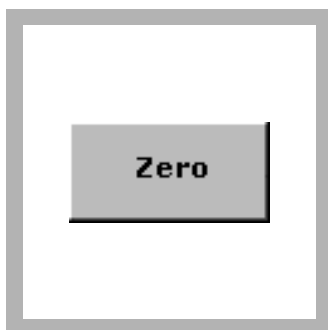

6. Press **ZERO**.
The display will show:
0.00 mg/L ClO₂

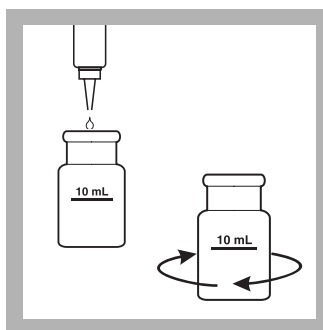

7. Add four drops of Glycine Reagent to the sample. Swirl to mix.

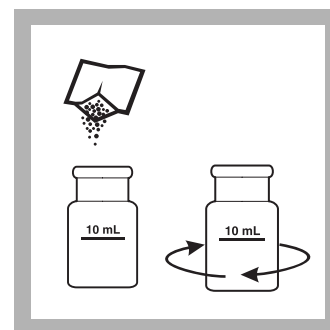

8. Add the contents of one DPD Free Chlorine Powder Pillow to the prepared sample cell.

Swirl the sample for 20 seconds to mix.



9. Wait 30 seconds for any undissolved powder to settle.

Immediately proceed to step 10.



10. Within one minute of adding the DPD reagent, wipe the sample cell and insert it into the cell holder with the fill line facing right.

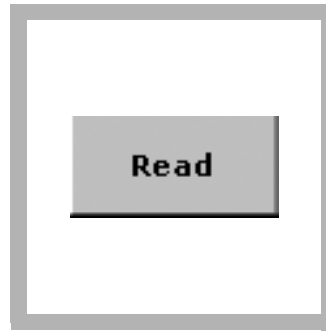

11. Press **READ**.

Results are in mg/L ClO₂.

AccuVac® Ampuls

Method 10126

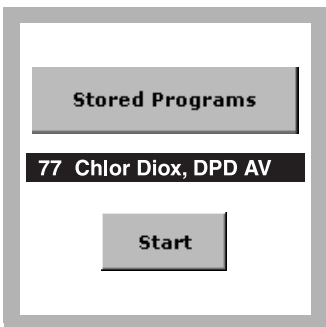

1. Select the test.

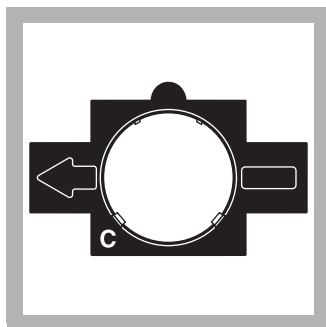

2. Insert the 1-inch round cell adapter (Adapter C).

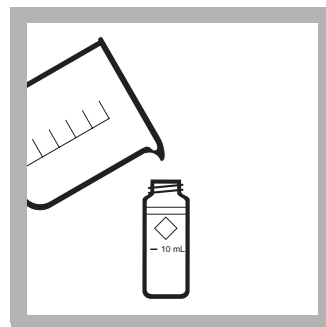

3. **Blank Preparation:** Fill a round sample cell with 10-mL of sample.

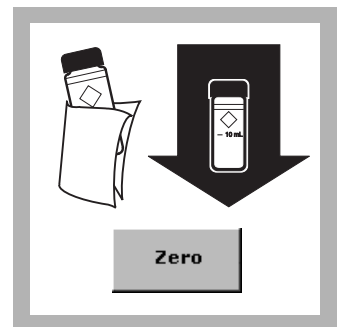

4. Wipe the blank and insert it into the cell holder.

Press **ZERO**.

The display will show: 0.00 mg/L ClO₂

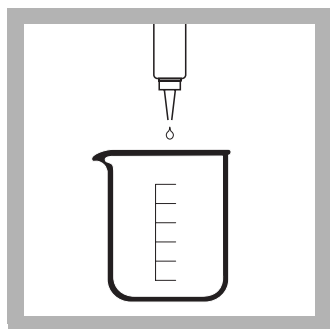

5. Prepared Sample:

Fill a 50-mL beaker with 40 mL of sample.

Add 16 drops of Glycine Reagent to the sample in the beaker. Swirl gently to mix.



6. Fill a DPD Free Chlorine Reagent AccuVac Ampul with sample. Keep the tip immersed while the Ampul fills completely.

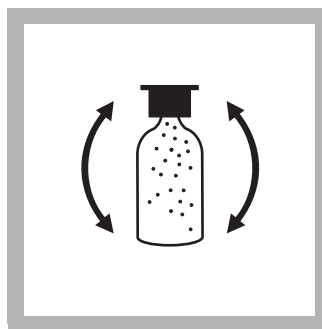

7. Quickly invert the Ampul several times to mix. Wait 30 seconds for any undissolved powder to settle.



8. Within one minute of adding the sample, wipe the Ampul and insert it into the cell holder.

Press **READ**. Results are in mg/L ClO₂.

Interferences

Table 1 Interfering Substances and Levels

Interfering Substance	Interference Levels and Treatments
Acidity	Greater than 150 mg/L CaCO ₃ . May not develop full color or color may fade instantly. Neutralize to pH 6–7 with 1 N Sodium Hydroxide ¹ . Determine amount to be added on separate sample aliquot, then add the same amount to the sample being tested. Correct for volume addition.
Alkalinity	Greater than 250 mg/L CaCO ₃ . Color may not develop fully or may fade instantly. Neutralize to pH 6–7 with 1 N Sulfuric Acid ¹ . Determine amount to be added on separate sample aliquot, then add the same amount to the sample being tested. Correct for the volume addition.
Bromine, Br ₂	Interferes at all levels.
Chlorine, Cl ₂	May interfere at levels greater than 6 mg/L. Additional glycine may be able to compensate for this interference.
Chloramines, organic	May interfere.
Flocculating agents	High levels of most flocculating agents can be tolerated. This tolerance is decreased if chlorine is present. See the information about metals in this table. In the presence of 0.6 mg/L Cl ₂ , Al(SO ₄) ₃ (< 500 mg/L) and FeCl ₂ (<200 mg/L) may be tolerated.
Hardness	No effect at less than 1000 mg/L as CaCO ₃ .
Iodine, I ₂	Interferes at all levels.
Manganese, oxidized (Mn ⁴⁺ , Mn ⁷⁺) or Chromium, oxidized (Cr ⁶⁺)	Oxidized manganese interferes at all levels. Oxidized chromium interferes at levels greater than 2 mg/L. To remove the interferences: <ol style="list-style-type: none"> 1. Adjust sample pH to 6–7. 2. Add 3 drops Potassium Iodide¹ (30 g/L) to a 25-mL sample. 3. Mix and wait one minute. 4. Add 3 drops Sodium Arsenite^{1, 2} (5 g/L) and mix. 5. Analyze 10 mL of the treated sample as described in the procedure. 6. Subtract the result of this test from the original analysis to obtain the correct chlorine dioxide concentration.

Table 1 Interfering Substances and Levels (continued)

Interfering Substance	Interference Levels and Treatments
Metals	Various metals may interfere by combining with the glycine needed to remove the chlorine interference. Metal interference is limited except when chlorine is present. In the presence of 0.6 mg/L Cl ₂ , both copper (>10 mg/L) and nickel (>50 mg/L) interfere. Other metals may also interfere, depending on their ability to prevent glycine from reacting with any Cl ₂ in the sample. It may be necessary to add more glycine to overcome this interference.
Monochloramine	Causes a gradual drift to higher readings. When read within 1 minute after reagent addition, 3 mg/L monochloramine causes less than a 0.1 mg/L ClO ₂ increase in the reading.
Ozone	Interferes at levels greater than 1.5 mg/L.
Peroxides	May interfere.
Extreme sample pH	Adjust to pH 6–7.
Highly buffered samples	Adjust to pH 6–7.

¹ See [Optional Reagents and Apparatus on page 7](#).

² Samples treated with sodium arsenite for interferences will be hazardous waste as regulated by Federal RCRA for arsenic (D004). Refer to a current MSDS for proper disposal instructions.

Sample Collection, Storage, and Preservation

Analyze samples for chlorine dioxide immediately after collection. Chlorine dioxide is a strong oxidizing agent and is unstable in natural waters. It reacts rapidly with various inorganic compounds, but oxidizes organic compounds more slowly. Many factors, including reactant concentrations, sunlight, pH, temperature, and salinity influence decomposition of chlorine dioxide in water.

Avoid plastic containers since these may have a large chlorine dioxide demand. Pretreat glass sample containers to remove any chlorine or chlorine dioxide demand by soaking in a dilute bleach solution (1 mL commercial bleach to 1 liter of deionized water) for at least one hour. Rinse thoroughly with deionized or distilled water. If sample containers are rinsed thoroughly with deionized or distilled water after use, only occasional pretreatment is necessary.

A common error in testing for chlorine dioxide is not obtaining a representative sample. If sampling from a tap, let the water flow for at least 5 minutes to ensure a representative sample. Let the container overflow with the sample several times, then cap the sample containers so there is no headspace (air) above the sample. If sampling with a sample cell, rinse the cell several times with the sample, then carefully fill to the 10-mL mark. Perform the chlorine dioxide analysis immediately.

Accuracy Check

Because chlorine dioxide is difficult and hazardous to produce, check the DPD and glycine reagents by using chlorine standards. Proceed as follows:

1. Prepare a 1-mg/L free chlorine standard using Method 1 or 2, below:

Method 1

- a. Use Free Chlorine Standard*.
- b. Determine the concentration of the standard from the certificate of analysis shipped with the standard (50–75 mg/L). Calculate the volume of standard needed as follows:
$$\text{mL standard needed} = 100 \frac{\text{standard concentration}}{\text{standard concentration}}$$
- c. Pipet the volume of standard needed into a 100-mL volumetric flask. Dilute to the line with chlorine-demand-free deionized water. Invert to mix.

Method 2

- a. Dilute 1 drop of 5% chlorine bleach in 1 liter of chlorine-demand-free deionized water. Use this as the standard.
- b. Verify the standard's concentration using the Free Chlorine Method 8021.
- c. Perform the chlorine dioxide test on the standard **without** adding glycine.
- d. For program 76, the chlorine dioxide reading should be 2.35 times greater than the chlorine result. For program 77, the chlorine dioxide reading should be 2.34 times greater than the chlorine result. If so, this verifies the DPD and the instrument are functioning properly.
- e. Repeat the chlorine dioxide test on the chlorine standard, including the glycine addition. The reading should be less than 0.10 mg/L. This verifies that the glycine is eliminating free chlorine interference.

Summary of Method

Chlorine dioxide reacts with DPD (N, N-diethyl-p-phenylenediamine) to the extent of one-fifth of its total available chlorine content corresponding to reduction of chlorine dioxide to chlorite to form a pink color. The color intensity is proportional to the ClO_2 in the sample. Chlorine interference is eliminated by adding glycine, which converts free chlorine to chloroaminoacetic acid, but has no effect on chlorine dioxide at the test pH. Test results are measured at 530 nm.

* See [Optional Reagents and Apparatus on page 7](#).

Consumables and Replacement Items

Required Reagents

Description	Quantity/Test	Unit	Cat. No.
Chlorine Dioxide DPD/Glycine Reagent Set (100 tests), includes:			27709-00
(1) DPD Free Chlorine Reagent Powder Pillows, 10-mL	1	100/pkg	21055-69
(1) Glycine Reagent	4 drops	29 mL	27621-33
OR			
Chlorine Dioxide DPD/Glycine AccuVac® Ampul Reagent Set (25 tests), includes:			27710-00
(1) DPD Free Chlorine Reagent AccuVac® Ampuls	1	25/pkg	25020-25
(1) Glycine Reagent	16 drops	29 mL	27621-33

Required Apparatus (Powder Pillows)

Description	Quantity/Test	Unit	Cat. No.
Sample Cells, 1-inch square, 10 mL, matched pair	2	2/pkg	24954-02
Stopper for 18 mm tube	2	6/pkg	1731-06

Required Apparatus (AccuVac)

Description	Quantity/Test	Unit	Cat. No.
Adapter, 1-inch round, for AccuVac Ampuls	1	each	LZV584
Beaker, 50-mL	1	each	500-41H
Sample Cell, 10-mL, with cap	1	each	21228-00
Stopper	1	6/pkg	1731-06

Recommended Standards

Description	Unit	Cat. No.
Chlorine Standard Solution, 10-mL Voluette® Ampule, 50–75 mg/L	16/pkg	14268-10
Water, deionized	4 L	272-56

Optional Reagents and Apparatus

Description	Cat. No.
Potassium Iodide, 30 g/L, 100 mL	each 343-32
Sodium Arsenite, 5 g/L, 100 mL	each 1047-32
Sodium Hydroxide, 1 N, 100 mL	each 1045-32
Stopper	25/pkg 1731-25
Sulfuric Acid, 1 N, 100 mL	each 1270-32



FOR TECHNICAL ASSISTANCE, PRICE INFORMATION AND ORDERING:

In the U.S.A. – Call toll-free 800-227-4224
Outside the U.S.A. – Contact the HACH office or distributor serving you.
On the Worldwide Web – www.hach.com; E-mail – techhelp@hach.com

HACH COMPANY
WORLD HEADQUARTERS
Telephone: (970) 669-3050
FAX: (970) 669-2932

Chlorine, Free

★Method 8021

DPD Method¹

Powder Pillows or AccuVac[®] Ampuls

(0.02 to 2.00 mg/L)

Scope and Application: For testing free chlorine (hypochlorous acid and hypochlorite ion) in water, treated waters, estuary, and seawater. USEPA accepted for reporting for drinking water analyses.²

¹ Adapted from *Standard Methods for the Examination of Water and Wastewater*.

² Procedure is equivalent to USEPA method 330.5 and Standard Method 4500-Cl G for drinking water.



Test Preparation

Before starting the test:

If the test overranges, dilute the sample with a known volume of high quality, chlorine demand-free water and repeat the test. Some loss of chlorine may occur due to the dilution. Multiply the result by the dilution factor. Alternatively, samples with high chlorine concentrations may be analyzed directly without dilution by using Method 10069, Chlorine, Free HR.

Collect the following items:

Quantity

	Quantity
Powder Pillow Test:	
DPD Free Chlorine powder pillow	1
Sample cells, 1-inch square, 10-mL	2
AccuVac Test:	
DPD Free Chlorine AccuVac [®] Ampul	1
Beaker, 50-mL	1
Sample cell, 10-mL round	1

Note: Reorder information for consumables and replacement items is on page 5.

Note: The SwifTest Dispenser for Free Chlorine can be used in place of the powder pillow in step 6.

Important Note: Analyze samples immediately. Do not preserve for later analysis.

Powder Pillows

Method 8021



1. Press **STORED PROGRAMS**.

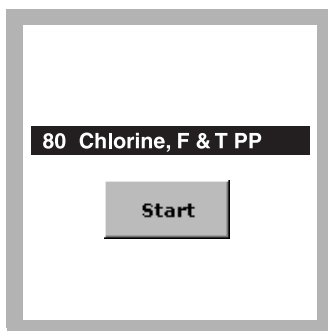

2. Select the test.

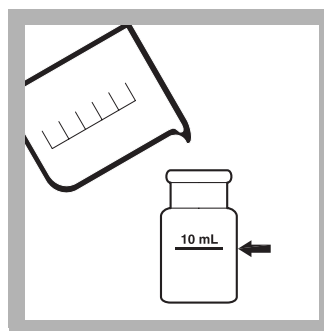

3. **Blank Preparation:**
Fill a square sample cell with 10 mL of sample.



4. Wipe the blank and insert it into the cell holder with the fill line facing right.

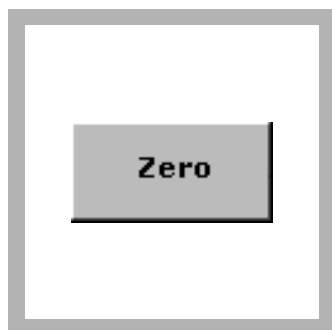

5. Press **ZERO**.
The display will show:
0.00 mg/L Cl₂

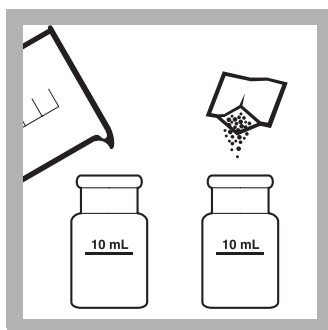

6. **Prepared Sample:**
Fill a second square cell with 10 mL of sample.
Add the contents of one DPD Free Chlorine Powder Pillow to the sample cell.

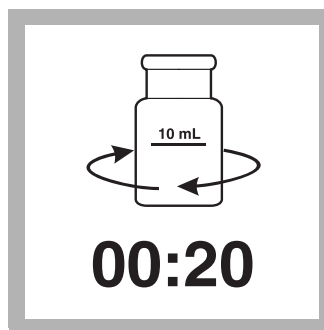

7. Swirl the sample cell for 20 seconds to mix.
A pink color will develop if chlorine is present.
Proceed to step 8 immediately.

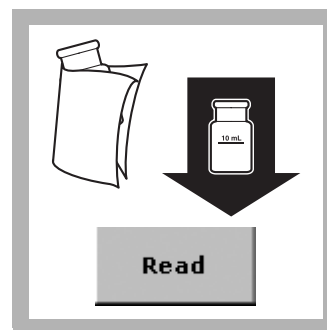

8. Within one minute of adding the reagent, insert the prepared sample into the cell holder with the fill line facing right.
Press **READ**.
Results are in mg/L Cl₂.

AccuVac® Ampuls

Method 8021

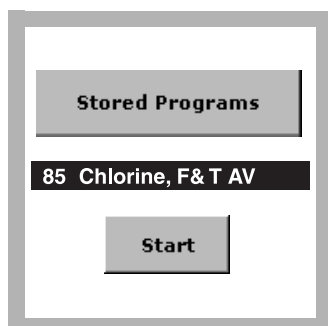

1. Select the test.

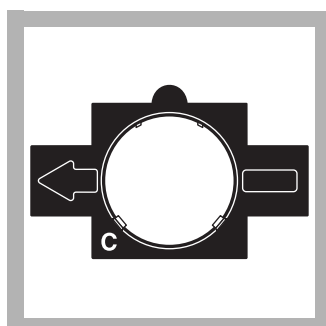

2. Insert Adapter C.

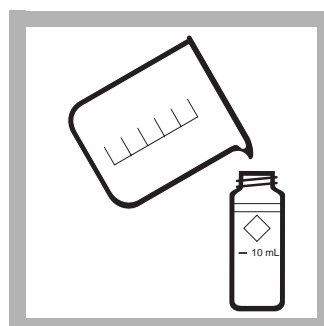

3. **Blank Preparation:**
Fill a round sample cell with 10-mL of sample.



4. Wipe the blank and insert it into the cell holder.

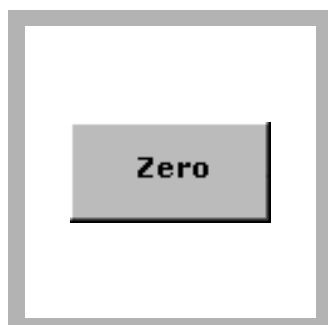

5. Press **ZERO**. The display will show: 0.00 mg/L Cl₂

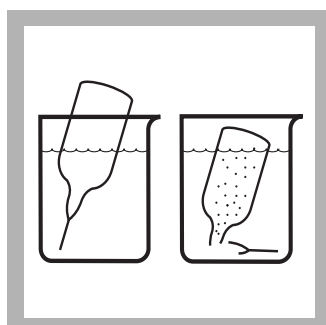

6. **Prepared Sample:**
Collect at least 40 mL of sample in a 50-mL beaker.

Fill a DPD Free Chlorine Reagent AccuVac Ampul with sample. Keep the tip immersed while the Ampul fills completely.

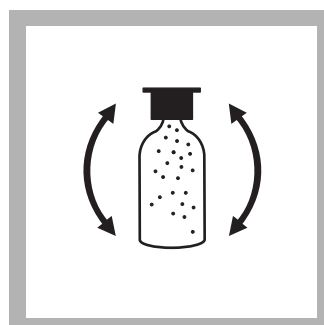

7. Quickly invert the Ampul several times to mix. Wipe off any liquid or fingerprints.



8. Within one minute after sample addition, wipe the AccuVac Ampul and insert it into the cell holder.

Press **READ**.

Results are in mg/L Cl₂.

Interferences

Table 1 Interfering Substances and Levels

Interfering Substance	Interference Levels and Treatments
Acidity	Greater than 150 mg/L CaCO ₃ . May not develop full color or color may fade instantly. Neutralize to pH 6–7 with 1 N Sodium Hydroxide ¹ . Determine amount to be added on separate sample aliquot, then add the same amount to the sample being tested. Correct for volume addition.
Alkalinity	Greater than 250 mg/L CaCO ₃ . May not develop full color or color may fade instantly. Neutralize to pH 6–7 with 1 N Sulfuric Acid ¹ . Determine amount to be added on separate sample aliquot, then add the same amount to the sample being tested. Correct for volume addition.
Bromine, Br ₂	Interferes at all levels
Chlorine Dioxide, ClO ₂	Interferes at all levels
Chloramines, organic	May interfere
Hardness	No effect at less than 1000 mg/L as CaCO ₃
Iodine, I ₂	Interferes at all levels

Table 1 Interfering Substances and Levels (continued)

Interfering Substance	Interference Levels and Treatments
Manganese, Oxidized (Mn ⁴⁺ , Mn ⁷⁺) or Chromium, Oxidized (Cr ⁶⁺)	Adjust sample pH to 6–7. Add 3 drops Potassium Iodide ¹ (30-g/L) to a 10-mL sample. Mix and wait one minute. Add 3 drops Sodium Arsenite ^{1, 2} (5-g/L) and mix. Analyze 10 mL of the treated sample as described in the procedure. Subtract the result from this test from the original analysis to obtain the correct chlorine concentration.
Monochloramine	Causes a gradual drift to higher readings. When read within 1 minute after reagent addition, 3 mg/L monochloramine causes less than a 0.1 mg/L increase in the reading.
Ozone	Interferes at all levels
Peroxides	May interfere
Extreme sample pH or Highly buffered samples	Adjust to pH 6–7 using acid (Sulfuric Acid ¹ , 1.000 N) or base (Sodium Hydroxide ¹ , 1.00 N).

¹ See [Optional Reagents and Apparatus on page 6](#).

² Samples treated with sodium arsenite for interferences will be hazardous waste as regulated by Federal RCRA for arsenic (D004). See the current MSDS for proper disposal of hazardous material.

Sample Collection, Storage, and Preservation

Analyze samples for chlorine immediately after collection. Free chlorine is a strong oxidizing agent and it is unstable in natural waters. It reacts rapidly with various inorganic compounds and more slowly oxidizes organic compounds. Many factors, including reactant concentrations, sunlight, pH, temperature, and salinity influence decomposition of free chlorine in water.

Avoid plastic containers since these may have a large chlorine demand. Pretreat glass sample containers to remove any chlorine demand by soaking in a dilute bleach solution (1 mL commercial bleach to 1 liter of deionized water) for at least 1 hour. Rinse thoroughly with deionized or distilled water. If sample containers are rinsed thoroughly with deionized or distilled water after use, only occasional pre-treatment is necessary.

Do not use the same sample cells for free and total chlorine. If trace iodide from the total chlorine reagent is carried over into the free chlorine determination, monochloramine will interfere. It is best to use separate, dedicated sample cells for free and total chlorine determinations.

A common error in testing for chlorine is not obtaining a representative sample. If sampling from a tap, let the water flow for at least 5 minutes to ensure a representative sample. Let the container overflow with the sample several times, then cap the sample containers so there is no headspace (air) above the sample. If sampling with a sample cell, rinse the cell several times with the sample, then carefully fill to the 10-mL mark. Perform the chlorine analysis immediately.

Accuracy Check

Standard Additions Method (Sample Spike)

1. After reading test results, leave the sample cell (unspiked sample) in the instrument.
2. Press **OPTIONS>MORE**. Press **STANDARD ADDITIONS**. A keypad will appear. Enter the average chlorine concentration shown on the certificate enclosed with the Chlorine Voluette®* Ampules. Press **OK**.

*See [Optional Reagents and Apparatus on page 6](#).

3. A summary of the Standard Additions procedure will appear. Press **OK** to accept the values for standard concentration, sample volume, and spike volumes as shown. Press **EDIT** to change these values. After the values are accepted, the unspiked sample reading will appear in the top row. See the user manual for more information.
4. Snap the neck off a LR Chlorine Voluette Ampule Standard, 25–30 mg/L Cl₂.
5. Prepare three sample spikes. Fill three mixing cylinders with 10 mL of sample. Use the TenSette® Pipet to add 0.1 mL, 0.2 mL, and 0.3 mL of standard, respectively, to each sample and mix thoroughly.

Note: For AccuVac® Ampuls, fill three mixing cylinders with 50 mL of sample and spike with 0.4 mL, 0.8 mL, and 1.2 mL of standard. Transfer 40 mL from each of the three mixing cylinders to three 50-mL beakers. Analyze each standard addition sample as described in the procedure above. Accept each standard additions reading by pressing **READ**. Each addition should reflect approximately 100% recovery.

6. Analyze each sample spike as described in the procedure above, starting with the 0.1 mL sample spike. Accept each standard additions reading by pressing **READ**. Each addition should reflect approximately 100% recovery.
7. After completing the sequence, press **GRAPH** to view the best-fit line through the standard additions data points, accounting for matrix interferences. Press **IDEAL LINE** to view relationships between the sample spikes and the “Ideal Line” of 100% recovery.

Summary of Method

Chlorine in the sample as hypochlorous acid or hypochlorite ion (free chlorine or free available chlorine) immediately reacts with DPD (N,N-diethyl-p-phenylenediamine) indicator to form a pink color, the intensity of which is proportional to the chlorine concentration. Test results are measured at 530 nm.

Consumables and Replacement Items

Required Reagents

Description	Quantity/Test	Unit	Cat. No.
DPD Free Chlorine Reagent Powder Pillows, 10-mL	1	100/pkg	21055-69
OR			
DPD Free Chlorine Reagent AccuVac® Ampuls	1		25020-25

Required Apparatus (Powder Pillows)

Description	Quantity/Test	Unit	Cat. No.
Sample Cells, 1-inch square, 10 mL, matched pair	2	2/pkg	24954-02

Required Apparatus (AccuVac)

Description	Quantity/Test	Unit	Cat. No.
Adapter, 1-inch round, for AccuVac Ampuls	1	each	LZV584
Beaker, 50-mL	1	each	500-41H
Sample Cell, 10-mL, with cap	1	each	21228-00

Recommended Standards

Description	Unit	Cat. No.
Chlorine Standard Solution, 2-mL Voluette® Ampule, 25–30 mg/L	20/pkg	26300-20

Optional Reagents and Apparatus

Description	Unit	Cat. No.
Chlorine-demand Free Water	—	26415-49
Cylinder, mixing	25 mL	20886-40
Cylinder, mixing	50 mL	1896-41
Sodium Hydroxide, 1 N	100 mL	1045-32
Sulfuric Acid, 1 N	100 mL	1270-32
Potassium Iodide, 30-g/L	100 mL	343-32
Sodium Arsenite, 5-g/L	100 mL	1047-32
SwifTest Dispenser for Free Chlorine	—	28023-00



FOR TECHNICAL ASSISTANCE, PRICE INFORMATION AND ORDERING:
In the U.S.A. – Call toll-free 800-227-4224
Outside the U.S.A. – Contact the HACH office or distributor serving you.
On the Worldwide Web – www.hach.com; E-mail – techhelp@hach.com

HACH COMPANY
WORLD HEADQUARTERS
Telephone: (970) 669-3050
FAX: (970) 669-2932

Chlorine, Free

Method 10102

DPD Method¹

Test 'N Tube™ Vials

(0.09 to 5.00 mg/L)

Scope and Application: For testing higher levels of free chlorine (hypochlorous acid and hypochlorite ion) in drinking water, cooling water, and industrial process water.

¹ Adapted from *Standard Methods for the Examination of Water and Wastewater*.



Test Preparation

Before starting the test:

Important Note: Install the light shield in Cell Compartment #2 before performing this test.

Analyze samples immediately. Do not preserve samples for later analysis.

For more accurate results, determine a reagent blank value for each new lot of reagent. Follow the procedure using deionized water in place of the sample. Subtract the reagent blank value from the final results or perform a reagent blank adjust.

After adding sample to the Test 'N Tube™, a pink color will develop if free chlorine is present.

Collect the following items:

Quantity

Light Shield

LZV646

Test 'N Tube™ DPD Free Chlorine Reagent

1

Note: Reorder information for consumables and replacement items is on page 4.

Test 'N Tube

Method 10102

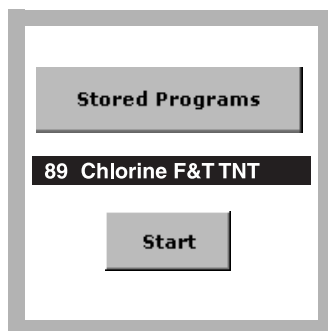

1. Select the test.

Install the Light Shield in Cell Compartment #2.

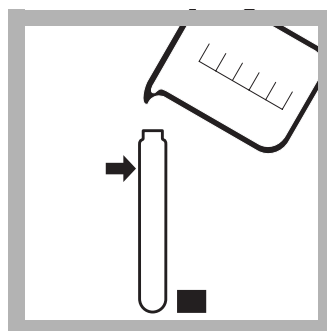

2. **Blank Preparation:**

Fill an empty Test 'N Tube vial to the top of the label with sample.

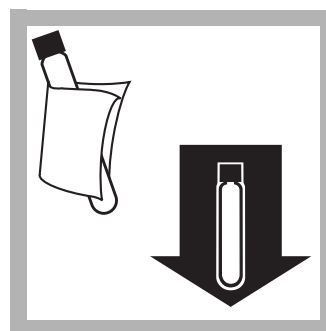

3. Wipe the blank and insert it into the 16 mm cell holder.

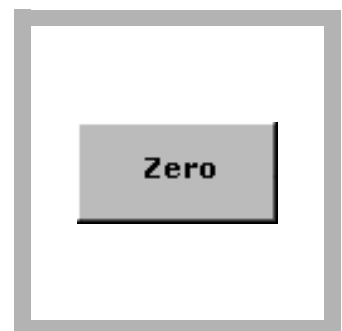

4. Press **ZERO**.

The display will show:
0.00 mg/L Cl₂

Chlorine, Free (0.09 to 5.00 mg/L)

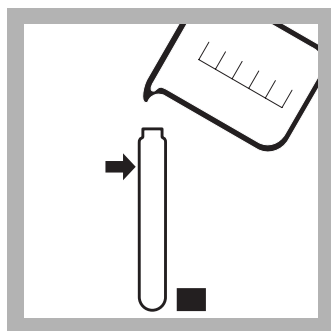

5. Remove the cap from a Free Chlorine DPD Test 'N Tube. Add 10 mL of sample to the tube. Fill the vial to the top of the label.

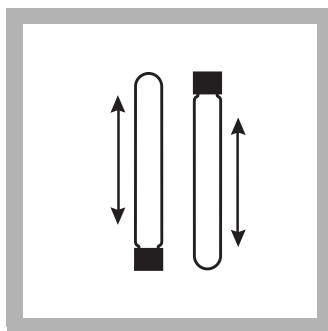

6. **Prepared Sample:** Cap and invert at least 10 times to dissolve the powder.



7. Immediately wipe the sample and insert it in the 16 mm cell holder.

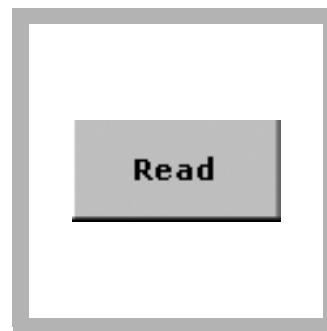

8. Press **READ**.
Results are in mg/L Cl₂.

Interferences

Table 1 Interfering Substances and Levels

Interfering Substance	Interference Levels and Treatments																								
Acidity	Greater than 150 mg/L CaCO ₃ . May not develop full color or color may fade instantly. Neutralize to pH 6–7 with 1 N sodium hydroxide ¹ . Determine amount to be added on separate sample aliquot, then add the same amount to the sample being tested. Correct for volume addition.																								
Alkalinity	Greater than 250 mg/L CaCO ₃ . May not develop full color or color may fade instantly. Neutralize to pH 6–7 with 1 N sulfuric acid ¹ . Determine amount to be added on separate sample aliquot, then add the same amount to the sample being tested. Correct for volume addition.																								
Bromine, Br ₂	Interferes at all levels																								
Chlorine Dioxide, ClO ₂	Interferes at all levels																								
Chloramines, organic	May interfere																								
Hardness	No effect at less than 1000 mg/L as CaCO ₃																								
Iodine, I ₂	Interferes at all levels																								
Manganese, oxidized (Mn ⁴⁺ , Mn ⁷⁺) or Chromium, oxidized (Cr ⁶⁺)	Adjust sample pH to 6–7. Add 3 drops potassium iodide ¹ (30-g/L) to a 25-mL sample. Mix and wait 1 minute. Add 3 drops sodium arsenite ² (5-g/L) and mix. Analyze 10 mL of the treated sample as described in the procedure. Subtract the result from this test from the original analysis to obtain the correct chlorine concentration in the sample.																								
Monochloramine	For conventional free chlorine disinfection (beyond the breakpoint), typical monochloramine concentrations are very low. If monochloramine is present in the sample, its interference in the free chlorine test depends on the sample temperature, relative amount of monochloramine to free chlorine, and the time required to do the analysis. Typical interference levels of monochloramine in the free chlorine test are listed below (as mg/L Cl ₂).																								
	<table border="1"> <thead> <tr> <th rowspan="2">NH₂Cl (as Cl₂)</th> <th colspan="4">Sample Temp. °C (°F)</th> </tr> <tr> <th>5 (40)</th> <th>10 (50)</th> <th>20 (68)</th> <th>30 (83)</th> </tr> </thead> <tbody> <tr> <td>1.2 mg/L</td> <td>+0.15</td> <td>0.19</td> <td>0.30</td> <td>0.29</td> </tr> <tr> <td>2.5 mg/L</td> <td>+0.35</td> <td>0.38</td> <td>0.55</td> <td>0.61</td> </tr> <tr> <td>3.5 mg/L</td> <td>+0.38</td> <td>0.56</td> <td>0.69</td> <td>0.73</td> </tr> </tbody> </table>	NH ₂ Cl (as Cl ₂)	Sample Temp. °C (°F)				5 (40)	10 (50)	20 (68)	30 (83)	1.2 mg/L	+0.15	0.19	0.30	0.29	2.5 mg/L	+0.35	0.38	0.55	0.61	3.5 mg/L	+0.38	0.56	0.69	0.73
NH ₂ Cl (as Cl ₂)	Sample Temp. °C (°F)																								
	5 (40)	10 (50)	20 (68)	30 (83)																					
1.2 mg/L	+0.15	0.19	0.30	0.29																					
2.5 mg/L	+0.35	0.38	0.55	0.61																					
3.5 mg/L	+0.38	0.56	0.69	0.73																					
Ozone, O ₃	Interferes at all levels																								

Table 1 Interfering Substances and Levels (continued)

Interfering Substance	Interference Levels and Treatments
Peroxides	May interfere
Extreme sample pH or Highly buffered samples	Adjust to pH 6–7 using acid (Sulfuric Acid ¹ , 1.000 N) or base (Sodium Hydroxide ¹ , 1.00 N).

¹ See [Optional Reagents and Apparatus on page 4](#).

² Samples treated with sodium arsenite for interferences will be hazardous waste as regulated by Federal RCRA for arsenic (D004). Refer to reagent MSDS for disposal instructions.

Sample Collection, Storage, and Preservation

Analyze samples for chlorine immediately after collection. Free chlorine is a strong oxidizing agent and it is unstable in natural waters. It reacts rapidly with various inorganic compounds and more slowly oxidizes organic compounds. Many factors, including reactant concentrations, sunlight, pH, temperature and salinity influence decomposition of free chlorine in water.

Avoid plastic containers since these may have a large chlorine demand. Pretreat glass sample containers to remove any chlorine demand by soaking in a dilute bleach solution (1 mL commercial bleach to 1 liter of deionized water) for at least 1 hour. Rinse thoroughly with deionized or distilled water. If sample containers are rinsed thoroughly with deionized or distilled water after use, only occasional pre-treatment is necessary.

A common error in testing for chlorine is not obtaining a representative sample. If sampling from a tap, let the water flow for at least 5 minutes to ensure a representative sample. Let the container overflow with the sample several times, then cap the sample containers so there is no headspace (air) above the sample. Perform the chlorine analysis immediately.

Accuracy Check

Standard Additions Method (Sample Spike)

1. After reading test results, leave the sample cell (unspiked sample) in the instrument. Verify that the units displayed are in mg/L.
2. Press **OPTIONS>MORE**. Press **STANDARD ADDITIONS**. A keypad will appear. Enter the average chlorine concentration shown on the certificate enclosed with the standard solution. Press **OK**. A summary of the Standard Additions procedure will appear. Press **OK**.
3. Snap the neck off of a HR Chlorine PourRite® Ampule Standard*, 50–75 mg/L Cl₂.
4. Use the TenSette® Pipet to add 0.1 mL to a 10-mL sample. Mix thoroughly.
5. Analyze the standard addition sample as described in the procedure above. Accept the standard additions reading by pressing **READ**. The addition should reflect approximately 100% recovery.

*See [Optional Reagents and Apparatus on page 4](#).

Summary of Method

Chlorine in the sample as hypochlorous acid or hypochlorite ion (free chlorine or free available chlorine) immediately reacts with DPD (N,N-diethyl-p-phenylenediamine) indicator to form a pink color which is proportional to the chlorine concentration. Test results are measured at 530 nm.

Consumables and Replacement Items

Required Reagents

Description	Quantity/Test	Unit	Cat. No.
Test 'N Tube™ DPD Free Chlorine Reagent	1	50/pkg	21055-45

Required Apparatus

Description	Quantity/Test	Unit	Cat. No.
Light Shield	1	each	LZV646

Recommended Standards and Apparatus

Description	Unit	Cat. No.
Chlorine Standard Solution, 2-mL PourRite® Ampule, 50–75 mg/L	20/pkg	14268-20

Optional Reagents and Apparatus

Description	Unit	Cat. No.
Kimwipes®	280/pkg	20970-00
Pipet, TenSette®, 0.1–1.0 mL	each	19700-01
Pipet Tips, for TenSette Pipet 19700-01	50/pkg	21856-96
Sulfuric Acid, 1.000 N, 100 mL	each	1270-32
Sodium Hydroxide, 1.00 N, 100 mL	each	1045-32



FOR TECHNICAL ASSISTANCE, PRICE INFORMATION AND ORDERING:
In the U.S.A. – Call toll-free 800-227-4224
Outside the U.S.A. – Contact the HACH office or distributor serving you.
On the Worldwide Web – www.hach.com; E-mail – techhelp@hach.com

HACH COMPANY
WORLD HEADQUARTERS
Telephone: (970) 669-3050
FAX: (970) 669-2932

Chlorine, Free

Method 10059

DPD Rapid Liquid Method¹

Pour-Thru™ Cell

(0.02 to 2.00 mg/L)

Scope and Application: For treated water.

¹ Adapted from *Standard Methods for the Examination of Water and Wastewater*.



Test Preparation

Before starting the test:

Analyze samples immediately. Do not preserve for later analysis.

Refer to the instrument User Manual for Pour-Thru cell and module assembly and installation.

Protect the Pour-Thru Cell from contamination when not in use by inverting a small beaker over the top of the glass funnel.

The indicator reagent must be prepared in advance. See [Reagent Preparation on page 2](#).

Collect the following items:

Quantity

DPD Indicator Powder	varies
Free Chlorine Indicator Solution	1 mL
Free Chlorine Buffer Solution	1 mL
Cylinder, glass, mixing, 100-mL	1
Dispenser, 1.0 mL fixed volume, Repipet Jr.	2
Pour-Thru Cell Module and Cell	1

Note: Reorder information for consumables and replacement items is on page 5.

Pour-Thru Cell

Method 10059

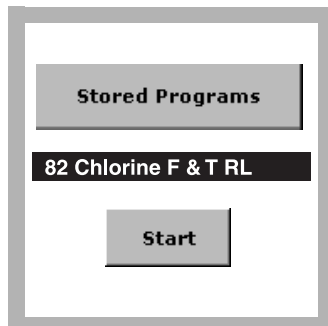

1. Select the test.

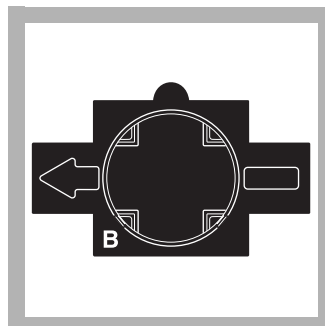

2. Insert Adapter B. Install the Pour-Thru Cell module and cell with the 1-inch (round) path in line with the arrow on the adapter. Flush the Pour-Thru cell with 50 mL of deionized water.

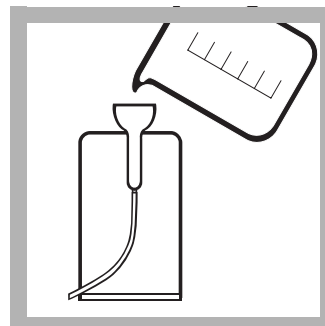

3. Pour approximately 50 mL of sample into the Pour-Thru Cell.

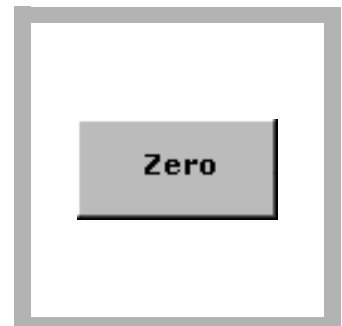

4. When the flow stops, press **ZERO**. The display will show: 0.00 mg/L Cl₂.

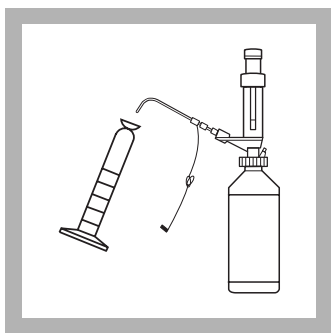

5. Add 1.0 mL of Free Chlorine Buffer Solution to a clean, dry 100-mL glass mixing cylinder using the Repipet Jr. Dispenser.

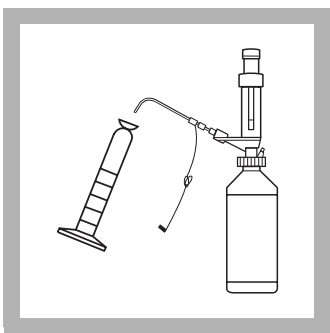

6. Add 1.0 mL of prepared Free Chlorine Indicator Solution to the same mixing cylinder using the Repipet Jr. Dispenser. Swirl to mix the reagents. Proceed to step 7 immediately.

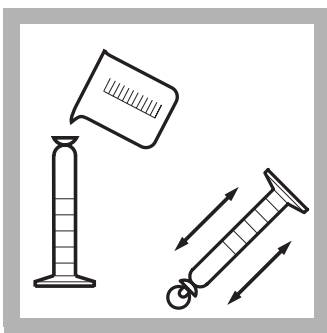

7. Carefully fill the mixing cylinder to the 80-mL mark with sample. Stopper the cylinder and gently invert it twice to mix. Proceed to step 8 immediately.

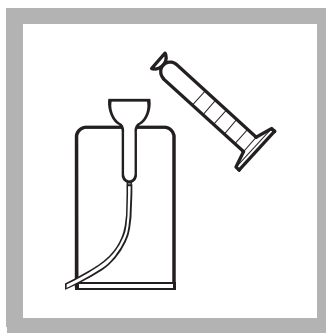

8. Fill the funnel of the Pour-Thru Cell with the reacted sample from the mixing cylinder.

(It is not necessary to pour the entire sample into the Pour-Thru Cell; approximately half of the sample may be discarded.)

After the flow stops, press **READ**. Results will appear in mg/L Cl₂.

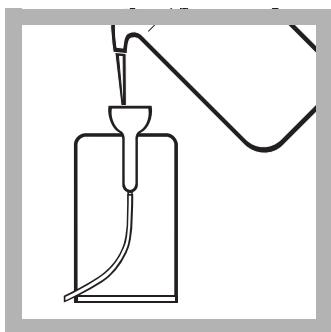

9. Flush the Pour-Thru Cell with at least 50-mL of deionized water immediately after use.

Reagent Preparation

The Free Chlorine Indicator Solution must be prepared before use. Using a powder funnel, add the contents of one 24 g bottle of DPD Powder* to one 473-mL bottle of Free Chlorine Indicator Solution*. Invert several times and swirl until the powder is completely dissolved. A pink color may develop, but should not affect results.

This solution will give accurate results for at least one month after mixing when stored at 20–25 °C (68–77 °C). Write the date of preparation on the Indicator Solution Bottle. Discard any remaining solution after one month. Use of this reagent after one month may result in high reagent blanks and low values at high concentration. Do not combine fresh reagent with previously mixed reagent.

* See [Required Reagents on page 5](#).

Interferences

Table 1 Interfering Substances and Levels

Interfering Substance	Interference Levels and Treatments
Alkalinity	Greater than 400 mg/L CaCO ₃ . May not develop full color or color may fade instantly. Neutralize to pH 6–7 with 1 N Sulfuric Acid ¹ . Determine amount to be added on separate sample aliquot, then add the same amount to the sample being tested. Correct for volume addition.
Bromine, Br ₂	Interferes at all levels.
Hardness	Levels below 1000 mg/L as CaCO ₃ will not interfere.
Iodine, I ₂	Interferes at all levels.
Manganese, oxidized (Mn ⁴⁺ , Mn ⁷⁺) or Chromium, oxidized (Cr ⁶⁺)	<ol style="list-style-type: none"> 1. Adjust sample pH to 6–7 with 1.000 N Sulfuric Acid¹. 2. Add 9 drops Potassium Iodide (30 g/L)¹ to an 80-mL sample. 3. Mix and wait 1 minute. 4. Add 9 drops Sodium Arsenite^{1, 2} (5 g/L) and mix. 5. Analyze the treated sample as described in the procedure above. 6. Subtract the result of this test from the original analysis to obtain the correct concentration.
Monochloramine (NH ₂ Cl)	Samples containing monochloramine will cause a gradual drift to higher chlorine readings. When read within one minute of reagent addition, 3.0 mg/L monochloramine will cause an increase of less than 0.1 mg/L in the free chlorine reading.
Ozone	Interferes at all levels.

¹ See [Optional Standards and Apparatus on page 5](#).

² Samples treated with sodium arsenite for interferences will be hazardous waste as regulated by the Federal RCRA for arsenic (D004). Refer to the current MSDS for safe handling and disposal instructions.

Sampling and Storage

Samples must be analyzed immediately and cannot be preserved for later analysis. A common testing error is introduced if the analyst does not obtain a representative sample. If sampling from a tap, let the water flow for at least five minutes to ensure a representative sample. Let the container overflow with the sample several times, then cap the sample container so there is no headspace (air) above the sample. Perform the chlorine analysis immediately.

Avoid plastic containers since these may have a chlorine demand. Pre-treat glass sample containers to remove any chlorine demand by soaking in a dilute bleach solution (1 mL commercial bleach to 1 liter of deionized water) for at least 1 hour. Rinse thoroughly with deionized water.

If sample containers are rinsed thoroughly with deionized water after use, only occasional pretreatment is necessary. A pre-treated glass BOD bottle with a ground-glass stopper makes an ideal sample container for chlorine analysis.

Treating Analysis Labware

Glassware used in this test must be chlorine demand-free. Fill the 100-mL mixing cylinder and sample container with a dilute solution of chlorine bleach prepared by adding 1 mL of commercial bleach to 1 liter of water. Soak in this solution at least one hour. After soaking, rinse thoroughly with deionized water and allow to dry before use. If the mixing cylinder is thoroughly rinsed with deionized water and allowed to dry after each use, only occasional pretreatment is necessary. Do not use the same mixing cylinder for Free and Total Chlorine analysis.

Treat the Pour-Thru Cell similarly with dilute bleach and let stand for several minutes. Rinse several times with deionized water.

Cleaning the Pour-Thru Cell

The Pour-Thru Cell may accumulate a buildup of colored reaction products, especially if the reacted solutions are allowed to remain in the cell for long periods after measurement. Remove the buildup by rinsing the cell with 5.25 N Sulfuric Acid* followed by several rinsings with deionized water.

Accuracy Check

Standard Additions Method (Sample Spike)

1. After reading test results, leave the sample cell (unspiked sample) in the instrument.
2. Press **OPTIONS>MORE**. Press **STANDARD ADDITIONS**. A keypad will appear. Enter the average chlorine concentration shown on the certificate enclosed with the chlorine voluette ampules. Press **OK**.
3. A summary of the Standard Additions procedure will appear. Press **OK** to accept the values for standard concentration, sample volume, and spike volumes as shown. Press **Edit** to change these values. After values are accepted, the unspiked sample reading will appear in the top row. See the user manual for more information.
4. Snap the top off a Chlorine Voluette® Ampule Standard Solution, 50 to 75-mg/L Cl₂.
5. Prepare three sample spikes. Use the TenSette® Pipet to add 0.3, 0.6 and 0.9 mL of standard to three 80-mL samples, respectively. Swirl gently to mix.
6. Analyze each sample spike as described in the procedure above, starting with the 0.1 mL sample spike. Accept each standard additions reading by pressing **READ**. Each addition should reflect approximately 100% recovery.
7. After completing the sequence, press **GRAPH** to view the best-fit line through the standard additions data points, accounting for the matrix interferences. Press **IDEAL LINE** to view the relationship between the sample spikes and the "Ideal Line" of 100% recovery.

Method Performance

Precision

Standard: 1.18 mg/L Cl₂

Program	95% Confidence Limits of Distribution
82	1.17–1.19 mg/L Cl ₂

Sensitivity

Portion of Curve	D Abs	D Concentration
Entire range	0.010	0.02 mg/L Cl ₂

Summary of Method

Chlorine in the sample as hypochlorous acid or hypochlorite ion (free chlorine or free available chlorine) immediately reacts with DPD (N,N-diethyl-p-phenylenediamine) indicator to form a red color which is proportional to the chlorine concentration. Test results are measured at 530 nm.

* See [Optional Standards and Apparatus on page 5](#).

Consumables and Replacement Items

Required Reagents

Description	Quantity/Test	Unit	Cat. No.
Free Chlorine Reagent Set, includes:	—	—	25569-00
DPD Indicator Powder	varies	24 g	22972-55
Free Chlorine Indicator Solution	1 mL	473 mL	23140-11
Free Chlorine Buffer Solution	1 mL	473 mL	23141-11

Required Apparatus

Description	Quantity/Test	Unit	Cat. No.
Adapter, for Multi-path and Pour-Thru cells	1	each	LZV585
Cylinder, graduated, 100-mL, poly	1	each	1896-42
Dispenser, fixed-volume, 1.0-mL, Repipet Jr.	2	each	21113-02
Pour-Thru Cell Module Kit	1	each	59404-00
Powder Funnel	1	each	22644-67

Recommended Standards

Description	Unit	Cat. No.
Chlorine Standard Solution, Voluette® Ampule, 50-75 mg/L, 10-mL	16/pkg	14268-10
OR		
Chlorine Standard Solution, Voluette® Ampule, 50-75 mg/L, 2-mL	20/pkg	14268-20
Water, deionized	4 L	272-56

Optional Standards and Apparatus

Description	Cat. No.
Pipet, TenSette® 0.1–1.0 mL	19700-01
Pipet Tips, for TenSette Pipet 19700-01, 50/pkg	21856-96
Potassium Iodide, 30 g/L, 100 mL	343-32
Sodium Arsenite, 5 g/L, 100 mL	1047-32
Sulfuric Acid, 1 N, 100 mL	1270-32
Sulfuric Acid, 5.25 N, 100 mL	2449-53



FOR TECHNICAL ASSISTANCE, PRICE INFORMATION AND ORDERING:

In the U.S.A. – Call toll-free 800-227-4224
Outside the U.S.A. – Contact the HACH office or distributor serving you.
On the Worldwide Web – www.hach.com; E-mail – techhelp@hach.com

HACH COMPANY
WORLD HEADQUARTERS
Telephone: (970) 669-3050
FAX: (970) 669-2932

Chlorine, Free

Method 10069

DPD Method¹

Powder Pillows

HR (0.1 to 10.0 mg/L as Cl₂)

Scope and Application: For testing higher levels of free chlorine (hypochlorous acid and hypochlorite ion) in drinking water, cooling water, and industrial process waters

¹ Adapted from *Standard Methods for the Examination of Water and Wastewater*.



Test Preparation

Before starting the test:

Analyze samples immediately. Do not preserve for later analysis.

If the chlorine concentration is less than 2 mg/L, use Method 8021, program number 80.

In bright light conditions (e.g. direct sunlight) it may be necessary to close the cell compartment with the protective cover during measurements.

Collect the following items:

Quantity

DPD Free Chlorine Reagent Powder Pillows

1

Sample Cell, 1-cm, 10-mL

1

Note: Reorder information for consumables and replacement items is on page 5.

Multi-path Cell

Method 10069

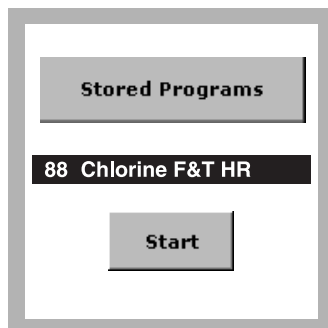

1. Select the test.

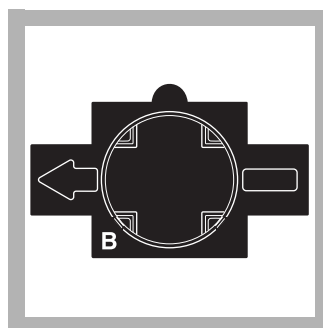

2. Insert cell Adapter B.

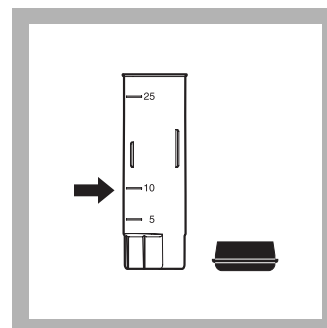

3. Fill the sample cell to the 5-mL line with sample.

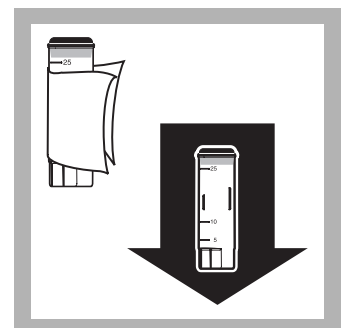

4. Wipe the cell and insert it into the cell holder with the 1-cm (flat) path in line with the indicator arrow on the adapter.

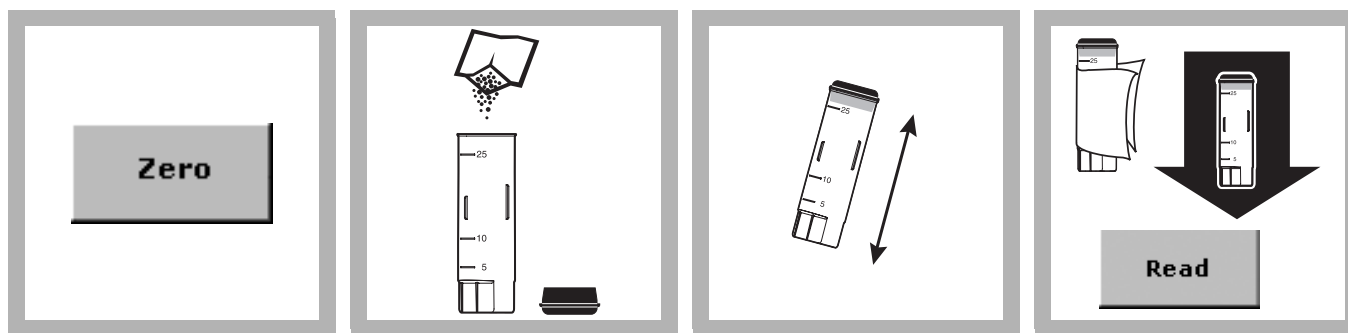

5. Press ZERO.

The display will show:
0.0 mg/L Cl₂

6. Remove the cell and add the contents of one DPD Free Chlorine powder pillow for 25-mL samples to the sample.

7. Cap and shake the cell about 20 seconds to dissolve reagent.

A pink color will develop if chlorine is present.

8. Insert the prepared sample into the cell holder with the 1-cm (flat) path in line with the indicator arrow on the adapter.

Press **READ**. Results are in mg/L Cl₂.

Interferences

Table 1 Interfering Substances and Levels

Interfering Substance	Interference Levels and Treatments
Acidity	Greater than 150 mg/L CaCO ₃ . May not develop full color or color may fade instantly. Neutralize to pH 6–7 with 1 N Sodium Hydroxide ¹ . Determine amount to be added on separate sample aliquot, then add the same amount to the sample being tested. Correct for volume addition.
Alkalinity	Greater than 250 mg/L CaCO ₃ . May not develop full color or color may fade instantly. Neutralize to pH 6–7 with 1 N Sulfuric Acid ¹ . Determine amount to be added on separate sample aliquot, then add the same amount to the sample being tested. Correct for volume addition.
Bromine, Br ₂	Interferes at all levels
Chlorine Dioxide, ClO ₂	Interferes at all levels
Chloramines, organic	May interfere
Iodine, I ₂	Interferes at all levels
Manganese, oxidized (Mn ⁴⁺ , Mn ⁷⁺) or Chromium, oxidized (Cr ⁶⁺)	<ol style="list-style-type: none"> Adjust sample pH to 6–7 with 1.000 N Sulfuric Acid¹. Add 2 drops Potassium Iodide¹ (30 g/L) to a 5-mL sample. Mix and wait 1 minute. Add 2 drops Sodium Arsenite^{1, 2} (5 g/L) and mix. Analyze the treated sample as described in the procedure above. Subtract the result of this test from the original analysis to obtain the correct concentration.

Table 1 Interfering Substances and Levels (continued)

Interfering Substance	Interference Levels and Treatments																													
Monochloramine (NH ₂ Cl)	<p>For conventional free chlorine disinfection (beyond the “breakpoint”), typical monochloramine concentrations are very low. If monochloramine is present in the sample, its interference in the free chlorine test is dependent on sample temperature, relative concentration of monochloramine to free chlorine, and the time required to perform the analysis.</p> <p>Typical interference levels of NH₂Cl (1 minute test time, interference as mg/L Cl₂):</p> <table border="1"> <thead> <tr> <th rowspan="2">NH₂Cl Level</th> <th colspan="4">Sample Temperature °C (°F)</th> </tr> <tr> <th>5 (41)</th> <th>10 (50)</th> <th>20 (68)</th> <th>30 (86)</th> </tr> </thead> <tbody> <tr> <td>1.2 mg/L</td> <td>+0.15</td> <td>0.19</td> <td>0.30</td> <td>0.29</td> </tr> <tr> <td>2.5 mg/L</td> <td>+0.35</td> <td>0.38</td> <td>0.55</td> <td>0.61</td> </tr> <tr> <td>3.5 mg/L</td> <td>+0.38</td> <td>0.56</td> <td>0.69</td> <td>0.73</td> </tr> <tr> <td>5.0 mg/L</td> <td>+0.68</td> <td>0.75</td> <td>0.93</td> <td>1.05</td> </tr> </tbody> </table>	NH ₂ Cl Level	Sample Temperature °C (°F)				5 (41)	10 (50)	20 (68)	30 (86)	1.2 mg/L	+0.15	0.19	0.30	0.29	2.5 mg/L	+0.35	0.38	0.55	0.61	3.5 mg/L	+0.38	0.56	0.69	0.73	5.0 mg/L	+0.68	0.75	0.93	1.05
NH ₂ Cl Level	Sample Temperature °C (°F)																													
	5 (41)	10 (50)	20 (68)	30 (86)																										
1.2 mg/L	+0.15	0.19	0.30	0.29																										
2.5 mg/L	+0.35	0.38	0.55	0.61																										
3.5 mg/L	+0.38	0.56	0.69	0.73																										
5.0 mg/L	+0.68	0.75	0.93	1.05																										
Ozone	Interferes at all levels																													
Peroxides	May interfere																													
Extreme sample pH or highly buffered samples	Adjust to pH 6–7 using acid (Sulfuric Acid ¹) or base (Sodium Hydroxide ¹).																													

¹ See [Optional Reagents and Apparatus on page 5](#).

² Samples treated with sodium arsenite for interferences will be hazardous waste as regulated by the Federal RCRA for arsenic (D004). Refer to the current MSDS for safe handling and disposal instructions.

Sampling and Storage

Analyze samples for chlorine immediately after collection. Free chlorine is a strong oxidizing agent and reacts rapidly with various compounds. Many factors such as sunlight, pH, temperature and sample composition will influence decomposition of free chlorine in water.

Avoid plastic containers since these may have a large chlorine demand. Pretreat glass sample containers to remove any chlorine demand by soaking in a dilute bleach solution (1 mL commercial bleach to 1 liter of deionized water) for at least 1 hour. Rinse thoroughly with deionized or distilled water. If sample containers are rinsed thoroughly with deionized or distilled water after use, only occasional pre-treatment is necessary.

Do not use the same sample cells for free and total chlorine. If trace iodide from the total chlorine reagent is carried over to the free chlorine test, monochloramine could interfere. It is best to use separate, dedicated sample cells for free and total chlorine determinations.

A common error in testing for chlorine is not obtaining a representative sample. If sampling from a tap, let the water flow for at least 5 minutes to ensure a representative sample. Let the container overflow with the sample several times, then cap the sample container so there is no headspace (air) above the sample. If sampling with a sample cell, rinse the cell several times with the sample, then carefully fill to the 5-mL mark. Proceed with the chlorine test immediately.

Accuracy Check

Standard Additions Method (Sample Spike)

1. After reading test results, leave the sample cell (unspiked sample) in the instrument.
2. Press **OPTIONS>MORE**. Press **STANDARD ADDITIONS**. A keypad will appear. Enter the average chlorine concentration shown on the certificate enclosed with the chlorine voluette ampules. Press **OK**.
3. A summary of the Standard Additions procedure will appear. Press **OK** to accept the values for standard concentration, sample volume, and spike volumes as shown. Press **EDIT** to change these values. After values are accepted, the unspiked sample reading will appear in the top row. See the user manual for more information.
4. Open a High Range Chlorine PourRite® Ampule Standard, 50–75 mg/L.
5. Prepare three sample spikes. Fill three mixing cylinders* with 5-mL of sample. Using the TenSette® Pipet*, add 0.1 mL, 0.2 mL, and 0.3 mL of standard, respectively, to each sample and mix thoroughly.
6. Analyze each standard addition sample as described in the procedure above. Accept each standard additions reading by pressing **READ**. Each addition should reflect approximately 100% recovery.

Summary of Method

The range of analysis using the DPD method for free chlorine can be extended by adding more indicator in proportion to sample volume. Thus, a larger fill powder pillow of DPD Free Chlorine Reagent is added to a 5-mL sample portion.

Chlorine in the sample as hypochlorous acid or hypochlorite ion (free chlorine or free available chlorine) immediately reacts with DPD (N, N-diethyl-p-phenylenediamine) indicator to form a magenta color which is proportional to the chlorine concentration. Test results are measured at 530 nm.

* See [Optional Reagents and Apparatus on page 5](#).

Consumables and Replacement Items

Required Reagents

Description	Quantity/Test	Unit	Cat. No.
DPD Free Chlorine Reagent Powder Pillows for 25-mL samples	1	100/pkg	14070-99

Required Apparatus

Description	Quantity/Test	Unit	Cat. No.
Adapter, for Multi-path and Pour-Thru cells	1	each	LZV585
Sample cell, multi-path	1	6/pkg	59405-06

Recommended Standards

Description	Unit	Cat. No.
Chlorine Standard Solution, 2-mL PourRite [®] Ampules, 50–75 mg/L	20/pkg	14268-20

Optional Reagents and Apparatus

Description	Cat. No.
Cylinder, mixing, 25 mL tall form	20886-40
Pipet, TenSette [®] , 0.1 to 1.0 mL	19700-01
Pipet Tips, for TenSette Pipet 19700-01	21856-96
Potassium Iodide, 30 g/L, 100 mL	343-32
Sodium Arsenite, 5 g/L, 100 mL	1047-32
Sodium Hydroxide.1 N, 100 mL	1045-32
Sulfuric Acid, 1 N, 100 mL	1270-32



FOR TECHNICAL ASSISTANCE, PRICE INFORMATION AND ORDERING:

In the U.S.A. – Call toll-free 800-227-4224
Outside the U.S.A. – Contact the HACH office or distributor serving you.
On the Worldwide Web – www.hach.com; E-mail – techhelp@hach.com

HACH COMPANY
WORLD HEADQUARTERS
Telephone: (970) 669-3050
FAX: (970) 669-2932

Chlorine, Total

★Method 8167

DPD Method¹

Powder Pillows or AccuVac[®] Ampuls

(0.02 to 2.00 mg/L)

Scope and Application: For testing residual chlorine and chloramines in water, wastewater, estuary water, and seawater; USEPA-accepted for reporting² for drinking and wastewater analyses.

¹ Adapted from *Standard Methods for the Examination of Water and Wastewater*

² Procedure is equivalent to USEPA method 330.5 and Standard Method 4500-Cl G for drinking water and wastewater analyses.



Test Preparation

Before starting the test:

Samples must be analyzed immediately and cannot be preserved for later analysis

If the test overranges, dilute the sample with a known volume of high quality, chlorine demand-free water, and repeat the test. Some loss of chlorine may occur due to the dilution. Multiply the result by the dilution factor. Or, analyze samples with high chlorine concentrations directly without dilution by using Method 10070, Chlorine, Total HR.

For chloramination disinfection control, use Method 10172, Chloramine (Mono), Low Range (program number 66) or High Range (program number 67).

The SwiftTest Dispenser¹ for Total Chlorine can be used in place of the powder pillow in step 4.

¹ [Optional Reagents and Apparatus on page 6.](#)

Collect the following items:

Quantity

Collect the following items:	Quantity
Powder Pillow Test:	
DPD Total Chlorine Reagent powder pillow, 10-mL	1
Sample Cells, 1-inch square, 10-mL	2
AccuVac Test:	
Collect at least 40 mL of sample in a 50-mL beaker	40 mL
DPD Total Chlorine Reagent AccuVac [®] Ampul	1
Beaker, 50-mL	1
Sample Cell, 10-mL round	1

Note: Reorder information for consumables and replacement items is on page 6.

Note: After adding the reagent, a pink color will develop if chlorine is present.

Powder Pillows

Method 8167



1. Press **STORED PROGRAMS**.

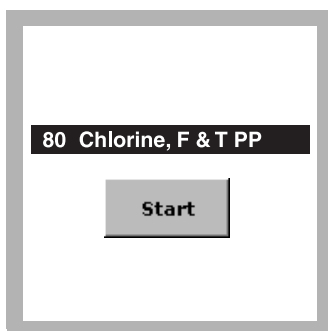

2. Select the test.

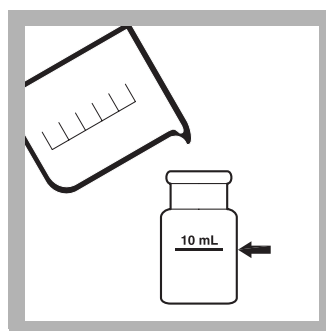

3. Fill a square sample cell with 10 mL of sample.

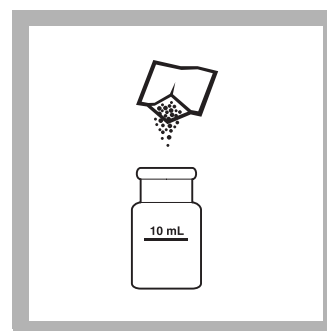

4. **Prepared Sample:** Add the contents of one DPD Total Chlorine Powder Pillow to the sample cell.

Swirl the sample cell for 20 seconds to mix.

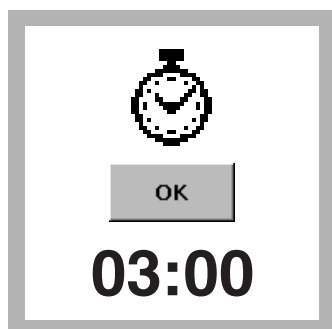

5. Press **TIMER>OK**.

A three-minute reaction period will begin. Perform steps 6 and 7 during this time period.

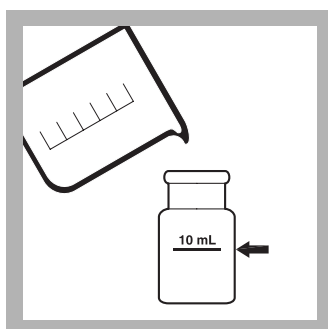

6. **Blank Preparation:** Fill a second square sample cell with 10-mL of sample.

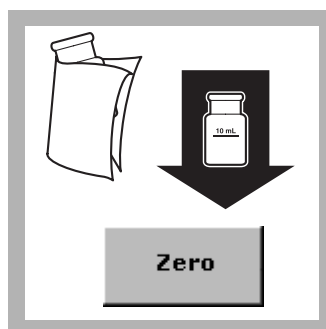

7. Wipe the blank sample cell and insert it into the cell holder with the fill line facing right.

Press **ZERO**. The display will show: 0.00 mg/L Cl₂

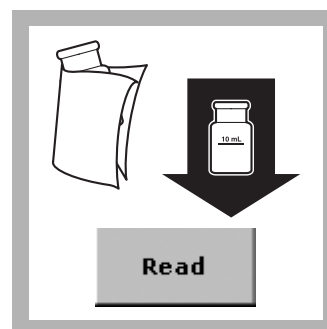

8. Within three minutes after the timer expires, wipe the prepared sample and insert it into the cell holder with the fill line facing right.

Press **READ**. Results are in mg/L Cl₂.

AccuVac® Ampul

Method 8167

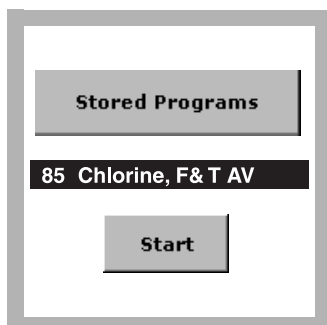

1. Select the test.

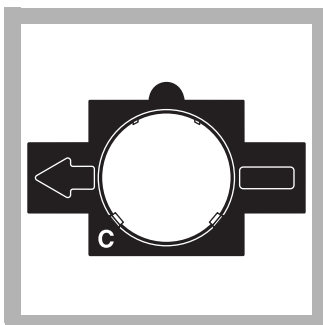

2. Insert Adapter C.

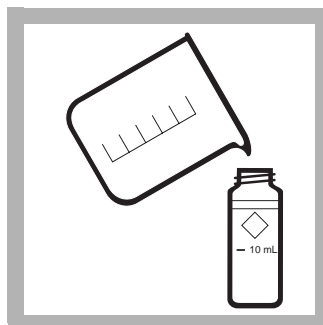

3. **Blank Preparation:**
Fill a round sample cell with 10-mL of sample.

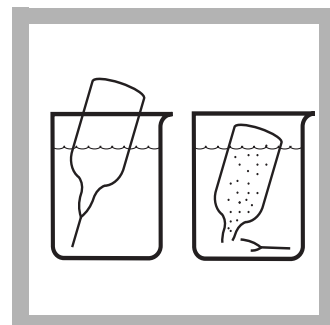

4. **Prepared Sample:**
Fill a DPD Total Chlorine Reagent AccuVac® Ampul with sample. Keep the tip immersed while the Ampul fills completely.

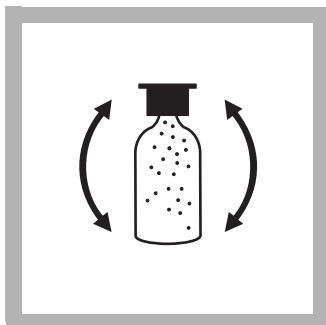

5. Quickly invert the Ampul several times to mix. Wipe off any liquid or fingerprints.



6. Press **TIMER>OK**.
A three-minute reaction period will begin. Perform steps 7 and 8 during this time period.

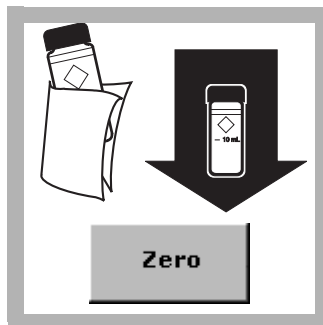

7. Wipe the blank and insert it into the cell holder. Press **ZERO**. The display will show: 0.00 mg/L Cl₂

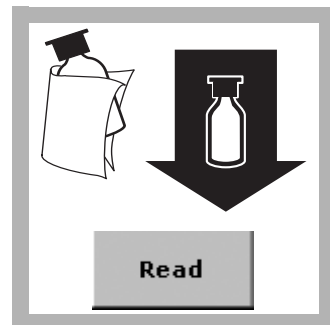

8. Within three minutes after the timer expires, wipe the AccuVac Ampul and insert it into the cell holder.

Press **READ**. Results are in mg/L Cl₂.

Interferences

Table 1 Interfering Substances and Levels

Interfering Substance	Interference Levels and Treatments
Acidity	Greater than 150 mg/L CaCO ₃ . May not develop full color or color may fade instantly. Neutralize to pH 6–7 with 1 N sodium hydroxide ¹ . Determine amount to be added on separate sample aliquot, then add the same amount to the sample being tested. Correct for volume addition.
Alkalinity	Greater than 300 mg/L CaCO ₃ . May not develop full color or color may fade instantly. Neutralize to pH 6–7 with 1 N sulfuric acid ¹ . Determine amount to be added on separate sample aliquot, then add the same amount to the sample being tested. Correct for volume addition.
Bromine, Br ₂	Interferes at all levels
Chlorine Dioxide	Interferes at all levels
Chloramines, organic	May interfere
Hardness	No effect at less than 1000 mg/L as CaCO ₃
Iodine, I ₂	Interferes at all levels
Manganese, Oxidized (Mn ⁴⁺ , Mn ⁷⁺) or Chromium, Oxidized (Cr ⁶⁺)	Adjust sample pH to 6–7. Add 3 drops potassium iodide ¹ (30 g/L) to a 25-mL sample. Mix and wait one minute. Add 3 drops sodium arsenite ^{1, 2} (5 g/L) and mix. Analyze 10 mL of the treated sample as described in the procedure. Subtract the result from this test from the original analysis to obtain the correct chlorine concentration.
Ozone	Interferes at all levels
Peroxides	May interfere
Extreme sample pH or Highly buffered samples	Adjust to pH 6–7 using acid (Sulfuric Acid ¹ , 1.000 N) or base (Sodium Hydroxide ¹ , 1.00 N).

¹ See [Optional Reagents and Apparatus on page 6](#).

² Samples treated with sodium arsenite for manganese or chromium interferences will be hazardous wastes as regulated by the Federal RCRA for arsenic (D004). Reference the current MSDS for more information on proper disposal of these materials.

Sample Collection, Storage, and Preservation

Analyze samples for chlorine immediately after collection. Chlorine is a strong oxidizing agent and it is unstable in natural waters. It reacts rapidly with various inorganic compounds and more slowly oxidizes organic compounds. Many factors, including reactant concentrations, sunlight, pH, temperature and salinity influence decomposition of chlorine in water.

Avoid plastic containers since these may have a large chlorine demand. Pretreat glass sample containers to remove any chlorine demand by soaking in a dilute bleach solution (1 mL commercial bleach to 1 liter of deionized water) for at least 1 hour. Rinse thoroughly with deionized or distilled water. If sample containers are rinsed thoroughly with deionized or distilled water after use, only occasional pre-treatment is necessary.

Do not use the same sample cells for free and total chlorine. If trace iodide from the total chlorine reagent is carried over into the free chlorine determination, monochloramine will interfere. It is best to use separate, dedicated sample cells for free and total chlorine determinations.

A common error in testing for chlorine is not obtaining a representative sample. If sampling from a tap, let the water flow for at least 5 minutes to ensure a representative sample. Let the container overflow with the sample several times, cap the sample containers so there is no headspace (air) above the sample. If sampling with a sample cell, rinse the cell several times with the sample, then carefully fill to the 10-mL mark. Perform the chlorine analysis immediately.

Accuracy Check

Standard Additions Method (Sample Spike)

1. After reading test results, leave the sample cell (unspiked sample) in the instrument.
2. Press **OPTIONS>MORE**. Press **STANDARD ADDITIONS**. A keypad will appear. Enter the average chlorine concentration shown on the certificate enclosed with the Chlorine Voluette® Ampules. Press **OK**.
3. A summary of the Standard Additions procedure will appear. Press **OK** to accept the values for standard concentration, sample volume, and spike volumes as shown. Press **EDIT** to change these values. After values are accepted, the unspiked sample reading will appear in the top row. See the user manual for more information.
4. Snap the neck off a LR Chlorine Voluette® Ampule Standard, 25–30 mg/L Cl₂.
5. Prepare three sample spikes. Fill three mixing cylinders* with 10 mL of sample. Use the TenSette® Pipet to add 0.1 mL, 0.2 mL and 0.3 mL of standard, respectively to three 10-mL samples and mix each thoroughly.

Note: For AccuVac® Ampuls, fill three mixing cylinders with 50-mL of sample and spike with 0.4 mL, 0.8 mL, and 1.2 mL of standard. Transfer 40 mL from each of the three mixing cylinders to three 50-mL beakers*. Analyze each standard addition sample as described in the procedure above. Accept each standard additions reading by pressing **READ**. Each addition should reflect approximately 100% recovery.

6. Analyze each sample spike as described in the procedure above, starting with the 0.1 mL sample spike. Accept each standard additions reading by pressing **READ**. Each addition should reflect approximately 100% recovery.
7. After completing the sequence, press **GRAPH** to view the best-fit line through the standard additions data points, accounting for the matrix interferences. Press **IDEAL LINE** to view the relationship between the sample spikes and the “Ideal Line” of 100% recovery.

Summary of Method

Chlorine can be present in water as free chlorine and as combined chlorine. Both forms can exist in the same water and be determined together as the total chlorine. Free chlorine is present as hypochlorous acid or hypochlorite ion. Combined chlorine exists as monochloramine, dichloramine, nitrogen trichloride and other chloro derivatives. The combined chlorine oxidizes iodide in the reagent to iodine. The iodine and free chlorine reacts with DPD (N,N-diethyl-p-phenylenediamine) to form a red color which is proportional to the total chlorine concentration. To determine the concentration of combined chlorine, run a free chlorine test. Subtract the results of the free chlorine test from the total chlorine test to obtain the combined chlorine concentration. Test results are measured at 530 nm.

* See [Optional Reagents and Apparatus on page 6](#).

Chlorine, Total (0.02 to 2.00 mg/L)

Consumables and Replacement Items

Required Reagents

Description	Quantity/Test	Unit	Cat. No.
DPD Total Chlorine Reagent Powder Pillows, 10-mL OR	1	100/pkg	21056-69
DPD Total Chlorine Reagent AccuVac® Ampuls	1	25/pkg	25030-25
Deionized Water	varies	4 L	272-56

Required Apparatus (Powder Pillows)

Description	Quantity/Test	Unit	Cat. No.
Sample Cells, 1-inch square, 10 mL, matched pair	2	2/pkg	24954-02

Required Apparatus (AccuVac)

Description	Quantity/Test	Unit	Cat. No.
Adapter, 1-inch round, for AccuVac Ampuls	1	each	LZV584
Beaker, 50-mL	1	each	500-41H
Sample Cell, 10-mL, round with cap	1	each	21228-00

Recommended Standards

Description	Unit	Cat. No.
Chlorine Standard Solution, 2-mL Voluette® Ampule, 25–30 mg/L	20/pkg	26300-20

Optional Reagents and Apparatus

Description	Unit	Cat. No.
Beakers, 50-mL	—	500-41H
Chlorine Demand-Free Water	—	26415-49
Cylinder, mixing	25 mL	20886-40
Cylinder, mixing	50 mL	1896-41
Potassium Iodide (30 g/L)	10 mL	343-32
Sodium Arsenite (5 g/L)	10 mL	1047-32
Sodium Hydroxide, 1 N	10 mL	1045-32
Sulfuric Acid, 1 N	10 mL	1270-32
SwifTest Dispenser for Total Chlorine	—	28024-00



FOR TECHNICAL ASSISTANCE, PRICE INFORMATION AND ORDERING:
In the U.S.A. – Call toll-free 800-227-4224
Outside the U.S.A. – Contact the HACH office or distributor serving you.
On the Worldwide Web – www.hach.com; E-mail – techhelp@hach.com

HACH COMPANY
WORLD HEADQUARTERS
Telephone: (970) 669-3050
FAX: (970) 669-2932

Chlorine, Total

Method 10070

DPD Method¹

Powder Pillows

HR (0.1 to 10.0 mg/L as Cl₂)

Scope and Application: For testing higher levels of total chlorine (free and combined) in drinking water, cooling water, and industrial process waters

¹ USEPA accepted for reporting drinking water analyses. Procedure is equivalent to USEPA Method 330.5 for Wastewater, and Standard Method 4500-Cl-G for Drinking Water



Test Preparation

Before starting the test:

Analyze samples immediately. Do not preserve for later analysis.

If the chlorine concentration is less than 2 mg/L, use Method 8021, program number 80.

In bright light conditions (e.g. direct sunlight) it may be necessary to close the cell compartment with the protective cover during measurements.

Collect the following items:

Quantity

DPD Total Chlorine Reagent Powder Pillows

1

Sample Cell, 1-cm, 10-mL

1

Note: Reorder information for consumables and replacement items is on page 4.

Multi-path Cell

Method 10070

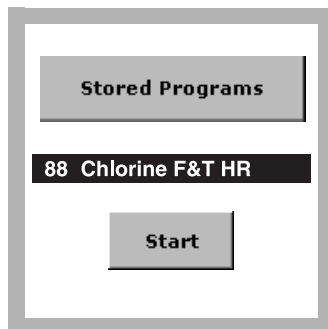

1. Select the test.

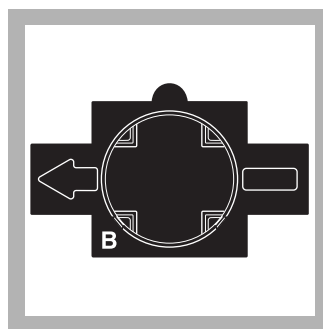

2. Insert Adapter B.

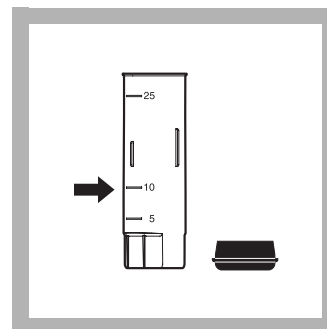

3. Fill the sample cell to the 5-mL line with sample.

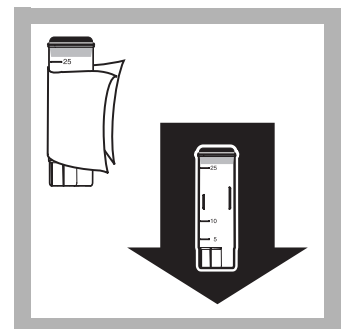

4. Wipe the cell and insert it into the cell holder with the 1-cm (flat) path in line with the indicator arrow on the adapter.

Chlorine, Total HR (0.1 to 10.0 mg/L as Cl₂)

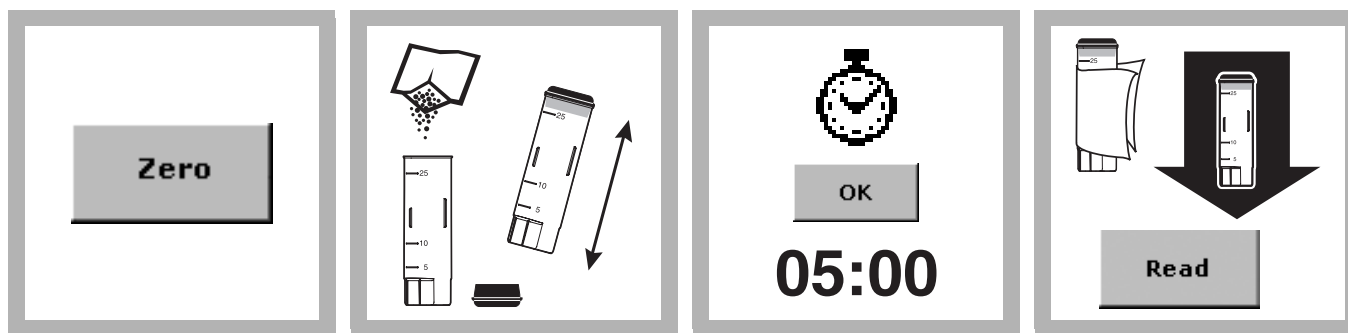

5. Press ZERO.

The display will show:
0.0 mg/L Cl₂

6. Remove the cell and add the contents of one DPD Total Chlorine powder pillow for 25-mL samples to the sample. Cap and shake the cell about 20 seconds to dissolve reagent.

A pink color will develop if chlorine is present.

7. Press TIMER>OK.

A 3-minute reaction period will begin.

8. Insert the prepared sample into the cell holder with the 1-cm (flat) path in line with the indicator arrow on the adapter.

Press **READ**. Results are in mg/L Cl₂.

Interferences

Table 1 Interfering Substances and Levels

Interfering Substance	Interference Levels and Treatments
Acidity	Greater than 150 mg/L CaCO ₃ . May not develop full color or color may fade instantly. Neutralize to pH 6–7 with 1 N Sodium Hydroxide ¹ . Determine amount to be added on separate sample aliquot, then add the same amount to the sample being tested. Correct for volume addition.
Alkalinity	Greater than 250 mg/L CaCO ₃ . May not develop full color or color may fade instantly. Neutralize to pH 6–7 with 1 N Sulfuric Acid ¹ . Determine amount to be added on separate sample aliquot, then add the same amount to the sample being tested. Correct for volume addition.
Bromine, Br ₂	Interferes at all levels
Chlorine Dioxide, ClO ₂	Interferes at all levels
Chloramines, organic	May interfere
Iodine, I ₂	Interferes at all levels
Manganese, oxidized (Mn ⁴⁺ , Mn ⁷⁺) or Chromium, oxidized (Cr ⁶⁺)	<ol style="list-style-type: none"> Adjust sample pH to 6–7 with 1.000 N Sulfuric Acid¹. Add 2 drops Potassium Iodide¹ (30 g/L) to a 5-mL sample. Mix and wait 1 minute. Add 2 drops Sodium Arsenite^{1, 2} (5 g/L) and mix. Analyze the treated sample as described in the procedure above. Subtract the result of this test from the original analysis to obtain the correct concentration.
Ozone	Interferes at all levels
Peroxides	May interfere
Extreme sample pH or highly buffered samples	Adjust to pH 6–7 using acid (Sulfuric Acid ¹) or base (Sodium Hydroxide ¹).

¹ See [Optional Reagents and Apparatus on page 4](#).

² Samples treated with sodium arsenite for interferences will be hazardous waste as regulated by the Federal RCRA for arsenic (D004). Refer to the current MSDS for safe handling and disposal instructions.

Sampling and Storage

Analyze samples for chlorine immediately after collection. Free and combined chlorine are strong oxidizing agents and react rapidly with various compounds. Many factors such as sunlight, pH, temperature and sample composition will influence decomposition of chlorine in water.

Avoid plastic containers since these may have a large chlorine demand. Pretreat glass sample containers to remove any chlorine demand by soaking in a dilute bleach solution (1 mL commercial bleach to 1 liter of deionized water) for at least 1 hour. Rinse thoroughly with deionized or distilled water. If sample containers are rinsed thoroughly with deionized or distilled water after use, only occasional pre-treatment is necessary.

Do not use the same sample cells for free and total chlorine. If trace iodide from the total chlorine reagent is carried over to the free chlorine test, monochloramine could interfere. It is best to use separate, dedicated sample cells for free and total chlorine determinations.

A common error in testing for chlorine is obtaining a representative sample. If sampling from a tap, let the water flow for at least 5 minutes to ensure a representative sample. Let the container overflow with the sample several times, then cap the sample container so there is no headspace (air) above the sample. If sampling with a sample cell, rinse the cell several times with the sample, then carefully fill to the 5-mL mark. Proceed with the chlorine test immediately.

Accuracy Check

Standard Additions Method (Sample Spike)

1. After reading test results, leave the sample cell (unspiked sample) in the instrument.
2. Press **OPTIONS>MORE**. Press **STANDARD ADDITIONS**. A keypad will appear. Enter the average chlorine concentration shown on the certificate enclosed with the chlorine voluette ampules. Press **OK**.
3. A summary of the Standard Additions procedure will appear. Press **OK** to accept the values for standard concentration, sample volume, and spike volumes as shown. Press **EDIT** to change these values. After values are accepted, the unspiked sample reading will appear in the top row. See the user manual for more information.
4. Open a High Range Chlorine PourRite® Ampule Standard, 50–75 mg/L.
5. Prepare three sample spikes. Fill three mixing cylinders* with 5-mL of sample. Using the TenSette® Pipet*, add 0.1 mL, 0.2 mL, and 0.3 mL of standard, respectively, to each sample and mix thoroughly.
6. Analyze each standard addition sample as described in the procedure above. Accept each standard additions reading by pressing **READ**. Each addition should reflect approximately 100% recovery.

* See [Optional Reagents and Apparatus on page 4](#).

Summary of Method

The range of analysis using the DPD method for total chlorine can be extended by adding more indicator in proportion to sample volume. Thus, a larger fill powder pillow of DPD Total Chlorine Reagent is added to a 5-mL sample portion.

The combined chlorine oxidizes iodide in the reagent to iodine. The iodine reacts with DPD (N, N-diethyl-p-phenylenediamine) along with free chlorine present in the sample to form a red color which is proportional to the total chlorine concentration. To determine the concentration of combined chlorine, run free chlorine and total chlorine tests. Subtract the results of the free chlorine test from the results of the total chlorine test to obtain combined chlorine. Test results are measured at 530 nm.

Consumables and Replacement Items

Required Reagents

Description	Quantity/Test	Unit	Cat. No.
DPD Total Chlorine Reagent Powder Pillows for 25-mL samples	1	100/pkg	14064-99

Required Apparatus

Description	Quantity/Test	Unit	Cat. No.
Adapter, for Multi-path and Pour-Thru cells	1	each	LZV585
Sample cell, multi-path	1	6/pkg	59405-06

Recommended Standards

Description	Unit	Cat. No.
Chlorine Standard Solution, 2-mL PourRite® Ampules, 50–75 mg/L	20/pkg	14268-20

Optional Reagents and Apparatus

Description	Cat. No.
Cylinder, mixing, 25 mL	1896-40
Pipet, TenSette®, 0.1 to 1.0 mL	19700-01
Pipet Tips, for TenSette Pipet 19700-01	21856-96
Potassium Iodide, 30 g/L, 100 mL	343-32
Sodium Arsenite, 5 g/L, 100 mL	1047-32
Sodium Hydroxide.1 N, 100 mL	1045-32
Sulfuric Acid, 1 N, 100 mL	1270-32



FOR TECHNICAL ASSISTANCE, PRICE INFORMATION AND ORDERING:
In the U.S.A. – Call toll-free 800-227-4224
Outside the U.S.A. – Contact the HACH office or distributor serving you.
On the Worldwide Web – www.hach.com; E-mail – techhelp@hach.com

HACH COMPANY
WORLD HEADQUARTERS
Telephone: (970) 669-3050
FAX: (970) 669-2932

Chlorine, Total

Method 10101

DPD Method¹

Test 'N Tube™ Vials

(0.09 to 5.00 mg/L)

Scope and Application: For testing higher levels of total (free plus combined) chlorine in drinking water, treated wastewater, cooling water, or industrial process water

¹ Adapted from *Standard Methods for the Examination of Water and Wastewater*.



Test Preparation

Before starting the test:

Important Note: Install the light shield in Cell Compartment #2 before performing this test.

Analyze samples immediately. Do not preserve samples for later analysis.

For more accurate results, determine a reagent blank value for each new lot of reagent. Follow the procedure using deionized water in place of the sample. Subtract the reagent blank value from the final results or perform a reagent blank adjust.

For chloramination disinfection control, use Method 10172, Chloramine (Mono), High Range.

After adding sample to the Test 'N Tube™, a pink color will develop if free chlorine is present.

Collect the following items:

Quantity

Light Shield

1

Test 'N Tube™ DPD Total Chlorine Reagent

1

Note: Reorder information for consumables and replacement items is on page 4.

Test 'N Tube

Method 10101

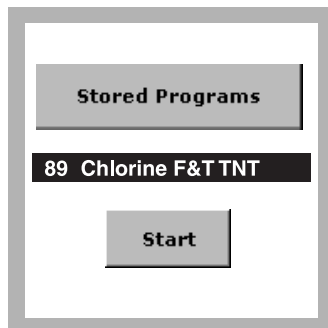

1. Select the test.

Install the Light Shield in Cell Compartment #2.

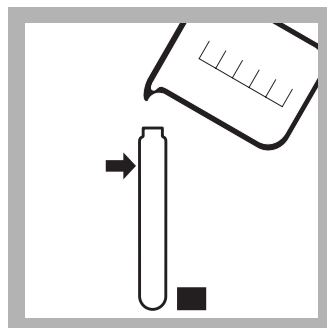

2. **Blank Preparation:**

Fill an empty Test 'N Tube vial to the top of the label with sample.



3. Wipe the outside of the vial to remove fingerprints and other marks.



4. Insert the blank into the 16 mm cell holder. Close the cover.

Chlorine, Total (0.09 to 5.00 mg/L)

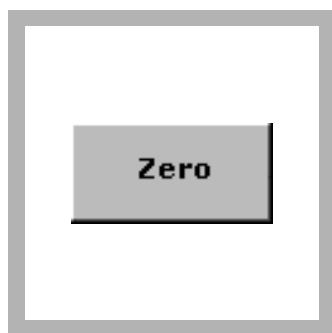

5. Press ZERO.

The display will show:

0.00 mg/L Cl₂

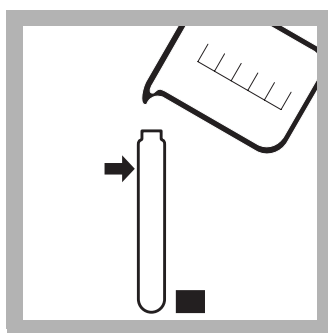

6. Prepared Sample:

Remove the cap from a Total Chlorine DPD Test 'N Tube™. Add 10 mL of sample to the tube. (Fill the vial to the top of the label.)

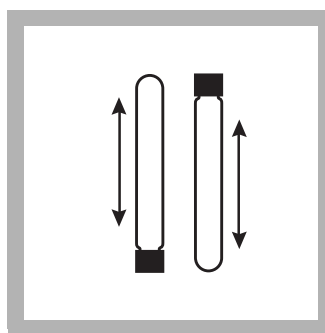

7. Cap and slowly invert at least 10 times to dissolve the powder. (Ten inversions should take at least 30 seconds. One inversion equals turning the vial upside down, then returning it to an upright position.)

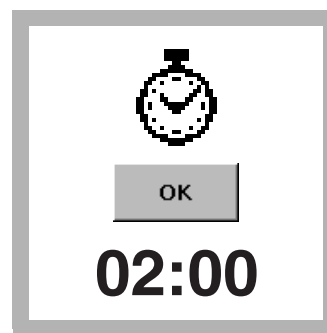

8. Press TIMER>OK.

A two-minute reaction period will begin.

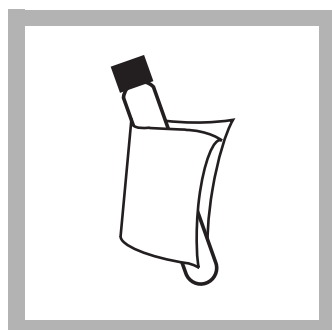

9. When the timer expires, wipe the outside of the vial that contains the prepared sample.

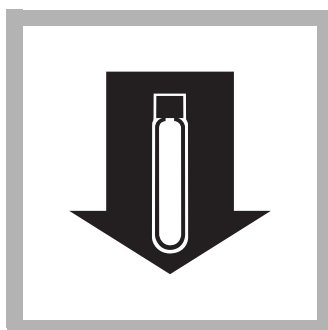

10. Insert the sample in the 16 mm cell holder.

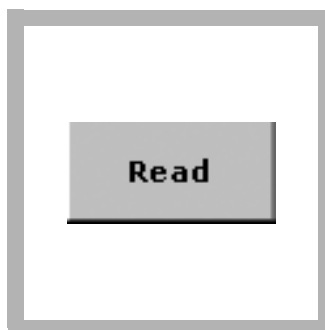

11. Press READ.
Results are in mg/L Cl₂.

Interferences

Table 1 Interfering Substances and Levels

Interfering Substance	Interference Levels and Treatment
Acidity	Greater than 150 mg/L CaCO ₃ . May not develop full color or color may fade instantly. Neutralize to pH 6–7 with 1 N Sodium Hydroxide ¹ . Determine amount to be added on separate sample aliquot, then add the same amount to the sample being tested. Correct for volume addition.
Alkalinity	Greater than 300 mg/L CaCO ₃ . May not develop full color or color may fade instantly. Neutralize to pH 6–7 with 1 N Sulfuric Acid ¹ . Determine amount to be added on separate sample aliquot, then add the same amount to the sample being tested. Correct for volume addition.
Bromine, Br ₂	Interferes at all levels
Chlorine Dioxide, ClO ₂	Interferes at all levels
Chloramines, organic	May interfere
Hardness	No effect at less than 1000 mg/L as CaCO ₃
Iodine, I ₂	Interferes at all levels

Table 1 Interfering Substances and Levels (continued)

Interfering Substance	Interference Levels and Treatment
Manganese, oxidized (Mn ⁴⁺ , Mn ⁷⁺) or Chromium, oxidized (Cr ⁶⁺)	Adjust sample pH to 6–7. Add 3 drops Potassium Iodide ¹ (30-g/L) to a 25-mL sample. Mix and wait 1 minute. Add 3 drops Sodium Arsenite ^{1, 2} (5-g/L) and mix. Analyze 10 mL of the treated sample as described in the procedure. Subtract the result of this test from the original analysis to obtain the correct chlorine concentration.
Ozone, O ₃	Interferes at all levels
Peroxides	May interfere
Extreme sample pH or highly buffered samples	Adjust to pH 6–7 using acid (Sulfuric Acid ¹ , 1.000 N) or base (Sodium Hydroxide ¹ , 1.00 N).

¹ See [Optional Reagents and Apparatus on page 4](#).

² Samples treated with sodium arsenite for manganese or chromium interferences will be hazardous wastes as regulated by the Federal RCRA for arsenic (D004). See the current reagent MSDS for safe disposal instructions.

Sample Collection, Storage, and Preservation

Analyze samples for chlorine immediately after collection. Free chlorine and combined chlorine are strong oxidizing agents and are unstable in natural waters. Many factors, including reactant concentrations, sunlight, pH, temperature, and salinity influence decomposition of free chlorine in water.

Avoid plastic containers since these may have a large chlorine demand. Pretreat glass sample containers to remove any chlorine demand by soaking in a dilute bleach solution (1 mL commercial bleach to 1 liter of deionized water) for at least one hour. Rinse thoroughly with deionized or distilled water. If sample containers are rinsed thoroughly with deionized or distilled water after use, only occasional pre-treatment is necessary.

A common error in testing for chlorine is obtaining an unrepresentative sample. If sampling from a tap, let the water flow for at least 5 minutes to ensure a representative sample. Let the container overflow with the sample several times, then cap the sample containers so there is no headspace (air) above the sample. Perform the chlorine analysis immediately.

Accuracy Check

Standard Additions Method (Sample Spike)

1. After reading test results, leave the sample cell (unspiked sample) in the instrument.
2. Press **OPTIONS>MORE**. Press **STANDARD ADDITIONS**. A keypad will appear. Enter the average chlorine concentration shown on the certificate enclosed with the Chlorine Voluette[®] Ampules. Press **OK**.
3. A summary of the Standard Additions procedure will appear. Press **OK** to accept the values for standard concentration, sample volume, and spike volumes as shown. Press **EDIT** to change these values. After values are accepted, the unspiked sample reading will appear in the top row. See the user manual for more information.
4. Snap the neck off a HR Chlorine PourRite[®] Ampule Standard, 50-75 mg/L Cl₂.
5. Use the TenSette[®] Pipet to add 0.1 mL of standard to a 10-mL sample and mix thoroughly.

Chlorine, Total (0.09 to 5.00 mg/L)

- Analyze the standard addition sample as described in the procedure above. Accept each standard additions reading by pressing **READ**. Each addition should reflect approximately 100% recovery.

Summary of Method

Chlorine can be present in water as free chlorine and as combined chlorine. Both forms can exist in the same water and be determined together as the total chlorine. Free chlorine is present as hypochlorous acid or hypochlorite ion. Combined chlorine exists as monochloramine, dichloramine, nitrogen trichloride and other chloro derivatives.

Free or combined chlorine oxidizes iodide in the reagent to iodine. The iodine and chlorine react with DPD (N,N-diethyl-p-phenylenediamine) to form a magenta color, which is proportional to the total chlorine concentration. To determine the concentration of combined chlorine, run a free chlorine test. Subtract the results of the free chlorine test from the total chlorine test to obtain the combined chlorine concentration. Test results are measured at 530 nm.

Consumables and Replacement Items

Required Reagents

Description	Quantity/Test	Unit	Cat. No.
Test 'N Tube™ DPD Total Chlorine Reagent	1	50/pkg	21056-45

Required Apparatus

Description	Quantity/Test	Unit	Cat. No.
Light Shield	1	each	LZV646

Recommended Standards

Description	Unit	Cat. No.
Chlorine Standard Solution, 2-mL PourRite® Ampule, 50–75 mg/L	20/pkg	14268-20

Optional Reagents and Apparatus

Description	Cat. No.
Pipet, TenSette®, 0.1–1.0 mL	19700-01
Pipet Tips, for TenSette Pipet 19700-01, 50/pkg	21856-96
Potassium Iodide 100 mL	343-32
Sodium Arsenite 5 g/L 100 mL	1047-32
Sodium Hydroxide, 1.00 N 100 mL	1045-32
Sulfuric Acid, 1.000 N 100 mL	1270-32



FOR TECHNICAL ASSISTANCE, PRICE INFORMATION AND ORDERING:
In the U.S.A. – Call toll-free 800-227-4224
Outside the U.S.A. – Contact the HACH office or distributor serving you.
On the Worldwide Web – www.hach.com; E-mail – techhelp@hach.com

HACH COMPANY
WORLD HEADQUARTERS
Telephone: (970) 669-3050
FAX: (970) 669-2932

Chlorine, Total

Method 10060

DPD Rapid Liquid Method¹

Pour-Thru Cell

(0.02 to 2.00 mg/L)

Scope and Application: For treated water.

¹ Adapted from *Standard Methods for the Examination of Water and Wastewater*.



Test Preparation

Before starting the test:

Analyze samples immediately. Do not preserve for later analysis.

Refer to the instrument User Manual for Pour-Thru cell and module assembly and installation.

Protect the Pour-Thru Cell from contamination when not in use by inverting a small beaker over the top of the glass funnel. Refer to [Reagent Preparation on page 3](#).

Collect the following items:

Quantity

DPD Indicator Powder	varies
Total Chlorine Indicator Solution	1 mL
Total Chlorine Buffer Solution	1 mL
Cylinder, glass, mixing, 100-mL	1
Dispenser, 1.0 mL fixed volume, Repipet Jr.	2
Pour-Thru Module and Cell	1

Note: Reorder information for consumables and replacement items is on page 5.

Pour-Thru Cell

Method 10060

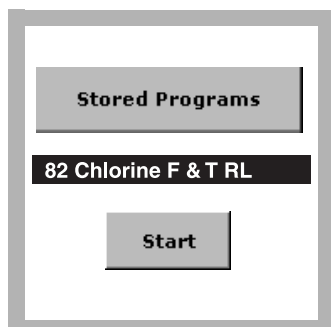

1. Select the test.

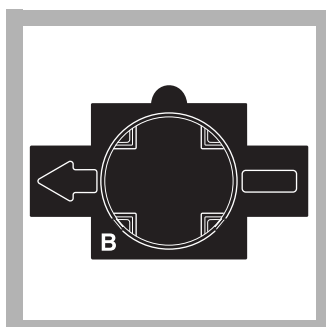

2. Insert Adapter B. Install the Pour-Thru Cell with the 1-inch (round) path in line with the adapter arrow. Flush the Pour-Thru cell with 50 mL of deionized water.

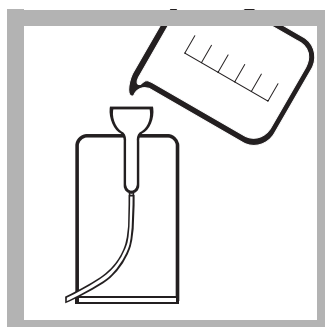

3. Pour approximately 50 mL of sample into the Pour-Thru Cell.

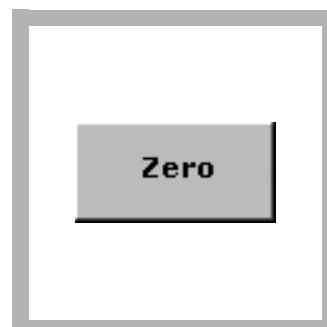

4. When the flow stops, press **ZERO**. The display will show: 0.00 mg/L Cl₂.

Chlorine, Total (0.02 to 2.00 mg/L)

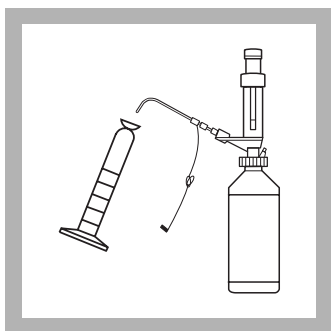

5. Add 1.0 mL of Total Chlorine Buffer Solution to a clean, dry 100-mL glass mixing cylinder using the Repipet Jr. Dispenser.

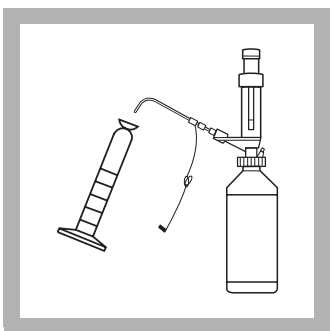

6. Add 1.0 mL of prepared Total Chlorine Indicator Solution to the same mixing cylinder using the Repipet Jr. Dispenser. Swirl to mix the reagents. Proceed to step **7** immediately.

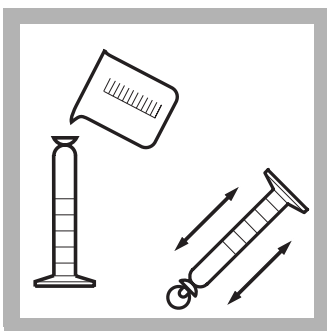

7. Carefully fill the mixing cylinder to the 80-mL mark with sample. Stopper the cylinder and gently invert it twice to mix. Proceed to step **8** immediately.

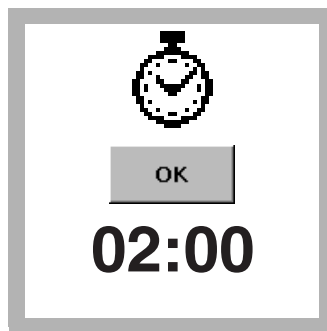

8. Press **TIMER>OK**.

A two-minute reaction period will begin.

Complete steps **9** and **10** within two minutes after the timer expires.

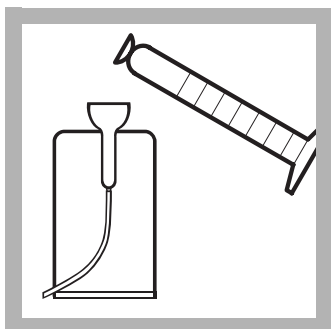

9. When the timer expires, fill the funnel of the Pour-Thru Cell with the reacted sample from the mixing cylinder.

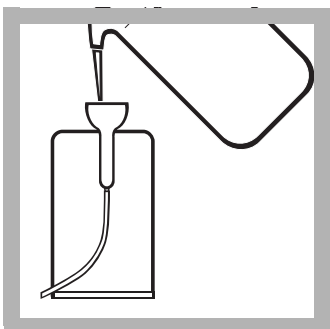

10. Flush the Pour-Thru Cell with at least 50-mL of deionized water immediately after use.

It is not necessary to pour the entire sample into the Pour-Thru Cell; approximately half of the sample may be discarded.

After the flow stops, press **READ**. Results will appear in mg/L Cl₂.

Reagent Preparation

The Total Chlorine Indicator Solution must be prepared before use. Using a powder funnel, add the contents of one 24 g bottle of DPD Powder* to one 473-mL bottle of Total Chlorine Indicator Solution*. Invert several times and swirl until the powder is completely dissolved. A pink color may develop, but should not affect results.

This solution will give accurate results for at least one month after mixing when stored at 20–25 °C (68–77 °C). Write the date of preparation on the Indicator Solution Bottle. Discard any remaining solution after one month. Use of this reagent after one month may result in high reagent blanks and low values at high concentration. Do not combine fresh reagent with previously mixed reagent.

Interferences

Table 1 Interfering Substances and Levels

Interfering Substance	Interference Levels and Treatments
Alkalinity	Greater than 700 mg/L CaCO ₃ . May not develop full color or color may fade instantly. Neutralize to pH 6–7 with 1 N Sulfuric Acid ¹ . Determine amount to be added on separate sample aliquot, then add the same amount to the sample being tested. Correct for volume addition.
Bromine, Br ₂	Interferes at all levels.
Hardness	Levels below 1000 mg/L as CaCO ₃ will not interfere.
Hexavalent Chromium	Levels greater than 1 mg/L will cause a positive interference.
Iodine, I ₂	Interferes at all levels.
Manganese, oxidized (Mn ⁴⁺ , Mn ⁷⁺) or Chromium, oxidized (Cr ⁶⁺)	<ol style="list-style-type: none"> 1. Adjust sample pH to 6–7 with 1.000 N Sulfuric Acid¹. 2. Add 9 drops Potassium Iodide (30 g/L)¹ to an 80-mL sample. 3. Mix and wait 1 minute. 4. Add 9 drops Sodium Arsenite^{1, 2} (5 g/L) and mix. 5. Analyze the treated sample as described in the procedure above. 6. Subtract the result of this test from the original analysis to obtain the correct concentration.
Ozone	Interferes at all levels.

¹ See [Optional Reagents and Apparatus on page 5](#).

² Samples treated with sodium arsenite for interferences will be hazardous waste as regulated by the Federal RCRA for arsenic (D004). Refer to the current MSDS for safe handling and disposal instructions.

Sampling and Storage

Samples must be analyzed immediately and cannot be preserved for later analysis. A common testing error is introduced if the analyst does not obtain a representative sample. If sampling from a tap, let the water flow for at least five minutes to ensure a representative sample. Let the container overflow with the sample several times, then cap the sample container so there is no headspace (air) above the sample. Perform the chlorine analysis immediately.

Avoid plastic containers since these may have a chlorine demand. Pre-treat glass sample containers to remove any chlorine demand by soaking in a dilute bleach solution (1 mL commercial bleach to 1 liter of deionized water) for at least 1 hour. Rinse thoroughly with deionized water. If sample containers are rinsed thoroughly with deionized water after use, only occasional pretreatment is necessary. A pre-treated BOD bottle with a ground-glass stopper is an ideal sample container for chlorine analysis.

* See [Required Reagents on page 5](#).

Treating Analysis Labware

Glassware used in this test must be chlorine demand-free. Fill the 100-mL mixing cylinder and sample container with a dilute solution of chlorine bleach prepared by adding 1 mL of commercial bleach to 1 liter of water. Soak in this solution at least one hour. After soaking, rinse thoroughly with deionized water and allow to dry before use. If the mixing cylinder is thoroughly rinsed with deionized water and allowed to dry after each use, only occasional pretreatment is necessary. Do not use the same mixing cylinder for Free and Total Chlorine analysis.

Treat the Pour-Thru Cell similarly with dilute bleach and let stand for several minutes. Rinse several times with deionized water.

Cleaning the Pour-Thru Cell

The Pour-Thru Cell may accumulate a buildup of colored reaction products, especially if the reacted solutions are allowed to remain in the cell for long periods after measurement. Remove the buildup by rinsing the cell with 5.25 N Sulfuric Acid* followed by several rinsings with deionized water.

Accuracy Check

Standard Additions Method (Sample Spike)

1. After reading test results, leave the sample cell (unspiked sample) in the instrument.
2. Press **OPTIONS>MORE**. Press **STANDARD ADDITIONS**. A keypad will appear. Enter the average chlorine concentration shown on the certificate enclosed with the chlorine voluette ampules. Press **OK**.
3. A summary of the Standard Additions procedure will appear. Press **OK** to accept the values for standard concentration, sample volume, and spike volumes as shown. Press **Edit** to change these values. After values are accepted, the unspiked sample reading will appear in the top row. See the user manual for more information.
4. Snap the top off a Chlorine Voluette® Ampule Standard Solution, 50 to 75-mg/L Cl₂.
5. Prepare three sample spikes. Use the TenSette® Pipet to add 0.3, 0.6 and 0.9 mL of standard to three 80-mL samples, respectively. Swirl gently to mix.
6. Analyze each sample spike as described in the procedure above, starting with the 0.3 mL sample spike. Accept each standard additions reading by pressing **READ**. Each addition should reflect approximately 100% recovery.
7. After completing the sequence, press **GRAPH** to view the best-fit line through the standard additions data points, accounting for the matrix interferences. Press **IDEAL LINE** to view the relationship between the sample spikes and the "Ideal Line" of 100% recovery.

* See [Optional Reagents and Apparatus on page 5](#).

Summary of Method

Chlorine can be present in water as free available chlorine and as combined available chlorine. Both forms can exist in the same water and can be determined together as the total available chlorine. Free chlorine is available as hypochlorous acid or hypochlorite ion. Combined chlorine exists as monochloramine, dichloramine, nitrogen trichloride, and other chloro derivatives. The combined chlorine oxidizes iodide in the reagent to iodine. The iodine reacts with DPD (N,N-diethyl-p-phenylenediamine) indicator along with free chlorine present in the sample to form a red color which is proportional to the total chlorine concentration. To determine the concentration of combined chlorine, run a free chlorine test. Subtract the results from the results of the total chlorine test to obtain combined chlorine. Test results are measured at 530 nm.

Consumables and Replacement Items

Required Reagents

Description	Quantity/Test	Unit	Cat. No.
Rapid Liquid Total Chlorine Reagent Set, includes:	—	—	25570-00
DPD Indicator Powder	varies	24 g	22972-55
Free Chlorine Indicator Solution	1 mL	473 mL	22634-11
Free Chlorine Buffer Solution	1 mL	473 mL	22635-11

Required Apparatus

Description	Quantity/Test	Unit	Cat. No.
Adapter, for Multi-path and Pour-Thru cells	1	each	LZV585
Cylinder, graduated, 100-mL, poly	1	each	1896-42
Dispenser, fixed-volume, 1.0-mL, Repipet Jr.	2	each	21113-02
Funnel, powder	1	each	22644-67
Pour-Thru Cell Module Kit	1	each	59404-00

Recommended Standards

Description	Unit	Cat. No.
Chlorine Standard Solution, Voluette® Ampule, 50-75 mg/L, 10-mL	16/pkg	14268-10
OR		
Chlorine Standard Solution, Voluette® Ampule, 50-75 mg/L, 2-mL	20/pkg	14268-20
Water, deionized	4 L	272-56

Optional Reagents and Apparatus

Description	Cat. No.
Pipet, TenSette®, 0.1–1.0 mL	19700-01
Pipet Tips, for TenSette Pipet 19700-01, 50 pkg	21856-96
Potassium Iodide, 30 g/L 100 mL	343-32
Sodium Arsenite, 5 g/L 100 mL	1047-32
Sulfuric Acid, 1 N 100 mL	1270-32
Sulfuric Acid, 5.25 N 1000 mL	2449-53



FOR TECHNICAL ASSISTANCE, PRICE INFORMATION AND ORDERING:

In the U.S.A. – Call toll-free 800-227-4224
Outside the U.S.A. – Contact the HACH office or distributor serving you.
On the Worldwide Web – www.hach.com; E-mail – techhelp@hach.com

HACH COMPANY
WORLD HEADQUARTERS
Telephone: (970) 669-3050
FAX: (970) 669-2932

Chlorine, Total

★Method 8370

DPD Method¹

Pour-Thru™ Cell

ULR (2 to 500 µg/L as Cl₂)

Scope and Application: For detecting trace levels of chlorine and chloramines in clean waters relatively free of color and turbidity; USEPA accepted for reporting for drinking water analysis

¹ U.S. Patent 5,362,650



Test Preparation

Before starting the test:

Analyze samples immediately. Samples containing chlorine cannot be preserved for later analysis.

A reagent blank value for a combined lot of indicator/buffer reagent solutions should be determined at least once a day. If sample color or turbidity fluctuates frequently during the day, determine a reagent blank for each sample.

Ampules contain more than 1.0 mL of solution for ease of transfer. Discard excess reagent in the ampule.

Refer to the instrument User Manual for Pour-Thru cell and module assembly and installation.

Protect the Pour-Thru Cell from contamination when not in use by inverting a small beaker over the top of the glass funnel. Refer to [Treating Analysis Labware on page 6](#).

Collect the following items:

Quantity

ULR Chlorine Buffer Solution, 1.5-mL ampules	1 mL
DPD Indicator Solution for ULR Chlorine, 1.5-mL ampules	1 mL
Blanking Reagent for ULR Chlorine	1 mL
Beaker, 250 mL	1
Cylinder, graduated mixing, 50-mL.	1
Pipet, TenSette®, 0.1 to 1.0 mL	1
Pipet Tips for TenSette Pipet	2
Pour-Thru Module and cell	1

Note: Reorder information for consumables and replacement items is on [page 8](#).

Pour-Thru Cell

Method 8370

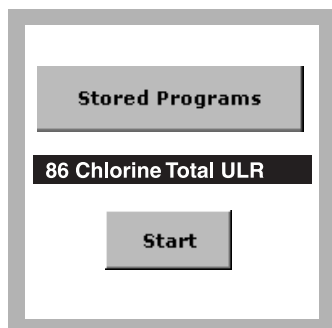

1. Select the test.

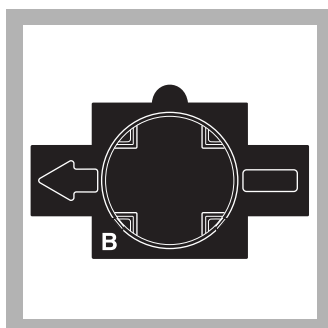

2. Insert Adapter B. Install the Pour-Thru Cell with the 1-inch (round) path in line with the adapter arrow. Flush the Pour-Thru cell with 50 mL of deionized water.

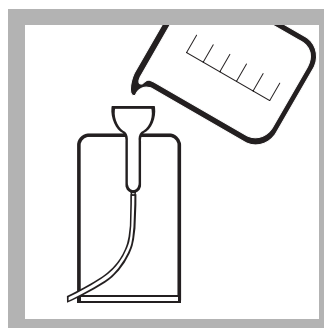

3. Pour at least 50 mL of sample into the Pour-Thru Cell.

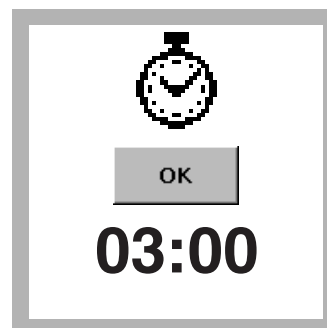

4. When the flow stops, press **TIMER>OK**.

A three-minute reaction period will begin. This time allows turbidity or solids to settle and ensures a stable reading.

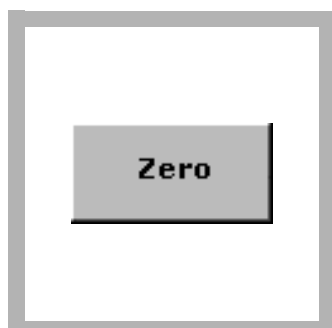

5. When the timer expires, press **ZERO**.
The display will show:
0 µg/L

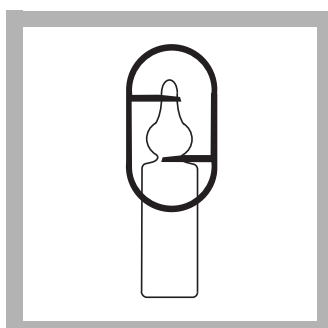

6. Break open one ULR Chlorine Buffer Solution Ampule.

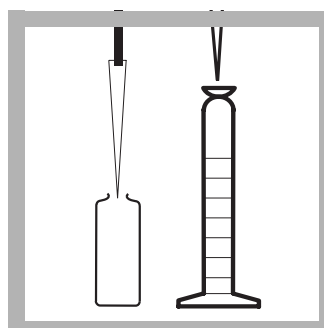

7. Using a TenSette® Pipet and a clean tip, transfer 1.0 mL of buffer from the ampule to a clean, treated 50-mL graduated mixing cylinder.

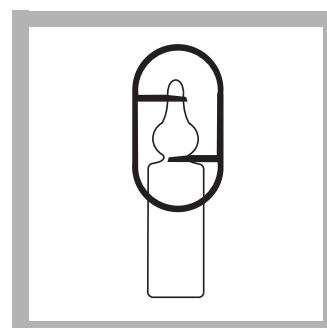

8. Break open one ampule of DPD Indicator Solution for Ultra Low Range Chlorine.

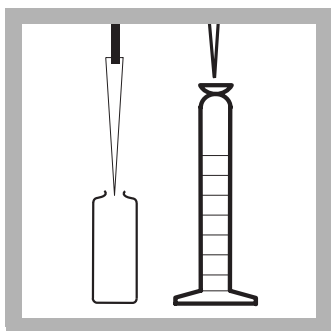

9. Using a TenSette Pipet and a clean tip, transfer 1.0 mL of indicator from the ampule to the graduated mixing cylinder. Swirl to mix.

Proceed to step 10 within one minute.

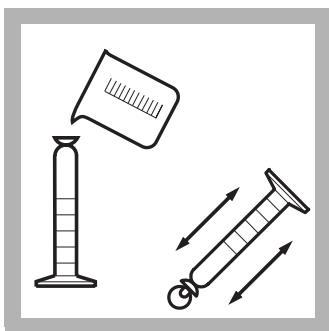

10. Prepared Sample: Avoiding extra agitation, carefully fill the cylinder to the 50-mL mark with sample. Stopper the cylinder. Gently invert it twice to mix.

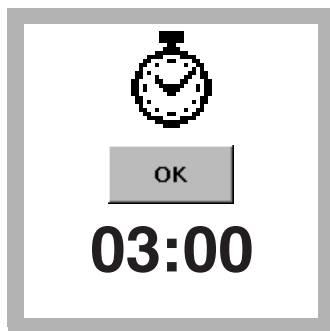

11. Press **TIMER>OK**.

A three-minute reaction time will begin.

Measure the reacted sample 3–4 minutes after mixing the sample and reagents. If less than three minutes elapses, the reaction with chloramines may be incomplete. A reading after four minutes may result in higher reagent blank values.

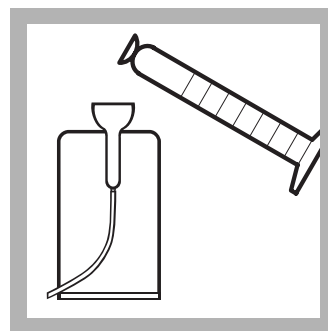

12. Introduce the contents of the graduated mixing cylinder into the Pour-Thru cell.

When the timer expires, press **READ**. Results are in µg/L chlorine.

If a dechlorinating agent (e.g. sulfite or sulfur dioxide) is present, the sample result (corrected for the reagent blank) will read “0” or a slightly negative value.

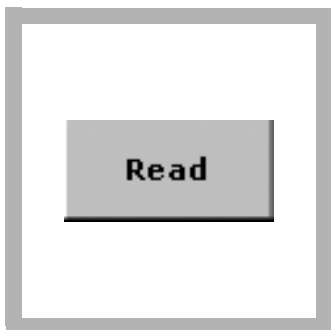

13. When the timer expires, press **READ**. Results are in µg/L chlorine.

If a dechlorinating agent (e.g. sulfite or sulfur dioxide) is present, the sample result (corrected for the reagent blank) will read “0” or a slightly negative value.

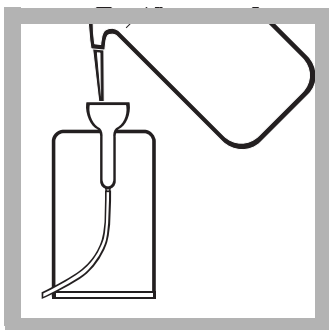

14. Flush the Pour-Thru Cell with at least 50-mL of deionized water immediately after use.

Determining the Reagent Blank Value

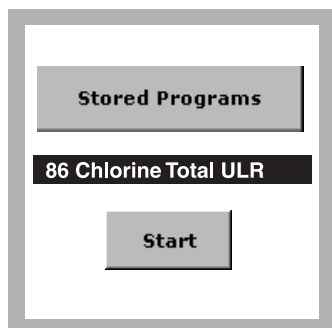

1. Select the test.

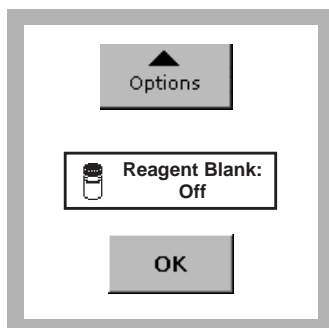

2. Make sure that the reagent blank setting is off.

Press **OPTIONS>MORE>REAGENT BLANK>OFF**. See the user manual for information.

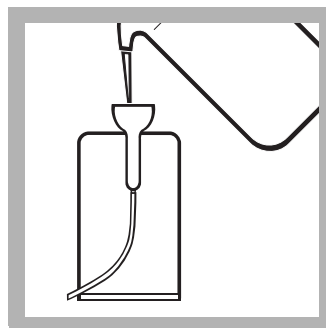

3. Insert Adapter B. Install the Pour-Thru module and cell with the 1-inch (round) path in line with the arrow on the adapter.

Flush the Pour-Thru cell with 50 mL of deionized water.

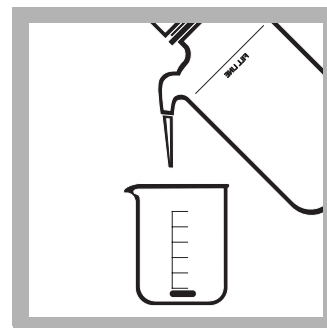

4. Collect about 100 mL of deionized or tap water in a clean, 250-mL beaker.

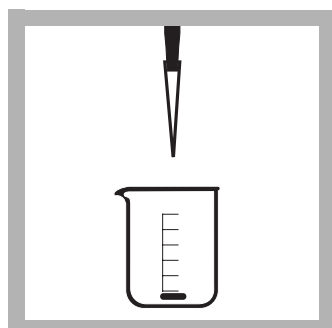

5. Using a TenSette® Pipet, add 1.0 mL of Blanking Reagent to the beaker. Swirl several times to mix.

The Blanking Reagent removes chlorine and chloramines from the water.

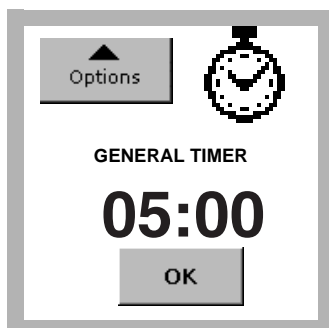

6. Press **OPTIONS>MORE>TIMER>GENERAL TIMER**.

Set a 5-minute timer and press **OK**.

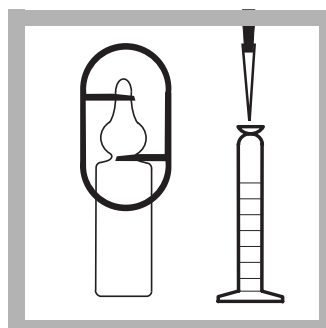

7. After the timer expires, break open one ampule of ULR Chlorine Buffer Solution. Using a TenSette Pipet and clean tip, transfer 1.0 mL of buffer from the ampule to a clean 50-mL mixing graduated cylinder.

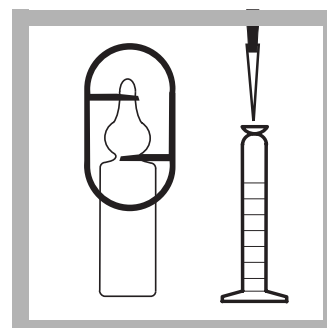

8. Break open one ampule of DPD Indicator Solution for Ultra Low Range Chlorine. Using a TenSette Pipet and a clean tip, transfer 1.0 mL of indicator from the ampule to the cylinder. Swirl to mix the reagents. Proceed to step 9 within one minute.

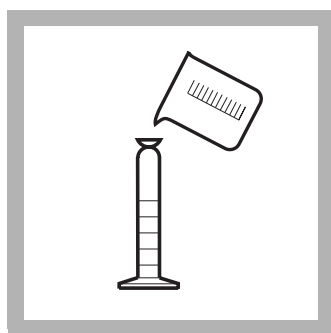

9. Fill the cylinder to the 50-mL mark with dechlorinated water from step 5. Cap and invert twice to mix. Save the remaining water for step 11.

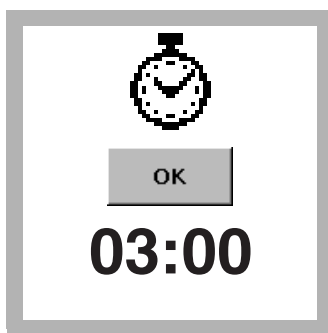

10. Press **TIMER>OK**. A three-minute reaction time will begin.

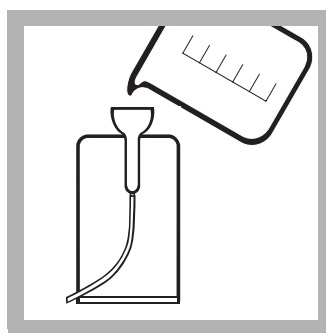

11. During the reaction period, flush the Pour-Thru Cell with the remainder of original dechlorinated water from step 9.

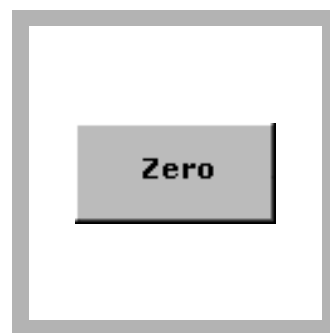

12. When the flow stops, press **ZERO**.

The display will show: 0 µg/L Cl₂.

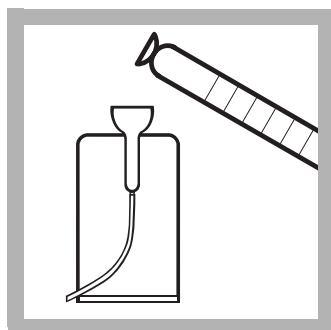

13. When the timer expires, introduce the contents of the cylinder into the Pour-Thru Cell. Press **READ**. Results are in µg/L chlorine.

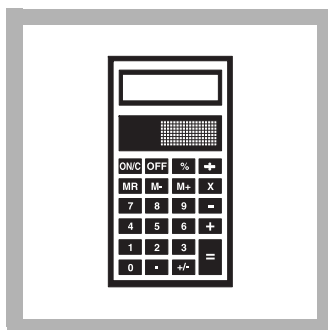

14. Use this value to correct the sample result obtained in this procedure. See the user manual for details on saving the reagent blank value.

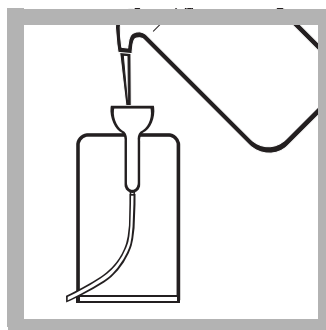

15. Flush the Pour-Thru Cell with at least 50-mL of deionized water immediately after use.

Interferences

Table 1 Interfering Substances and Levels

Interfering Substance	Interference Levels and Treatments
Bromine, Br ₂	Interferes at all levels
Chlorine Dioxide, ClO ₂	Interferes at all levels
Chloramines, organic	May interfere
Copper, Cu ²⁺	Greater than 1000 µg/L
Iodine, I ₂	Interferes at all levels.
Iron (Fe ³⁺)	Greater than 1000 µg/L

Table 1 Interfering Substances and Levels (continued)

Interfering Substance	Interference Levels and Treatments												
Manganese, oxidized (Mn ⁴⁺ , Mn ⁷⁺) or Chromium, oxidized (Cr ⁶⁺)	<ol style="list-style-type: none"> 1. Adjust sample pH to 6–7 with 1.000 N Sulfuric Acid¹. 2. Add 9 drops Potassium Iodide (30 g/L)¹ to an 80-mL sample. 3. Mix and wait 1 minute. 4. Add 9 drops Sodium Arsenite^{1, 2} (5 g/L) and mix. 5. Analyze the treated sample as described in the procedure above. 6. Subtract the result of this test from the original analysis to obtain the correct concentration. 												
Nitrite, NO ₂ ⁻ (uncommon in clean waters)	<table border="1" style="margin-left: auto; margin-right: auto;"> <thead> <tr> <th data-bbox="584 541 932 583">mg/L nitrite</th> <th data-bbox="932 541 1279 583">Apparent µg/L chlorine</th> </tr> </thead> <tbody> <tr> <td data-bbox="584 583 932 625">2.0 mg/L</td> <td data-bbox="932 583 1279 625">3 µg/L</td> </tr> <tr> <td data-bbox="584 625 932 667">5.0 mg/L</td> <td data-bbox="932 625 1279 667">5 µg/L</td> </tr> <tr> <td data-bbox="584 667 932 709">10.0 mg/L</td> <td data-bbox="932 667 1279 709">7 µg/L</td> </tr> <tr> <td data-bbox="584 709 932 751">15.0 mg/L</td> <td data-bbox="932 709 1279 751">16 µg/L</td> </tr> <tr> <td data-bbox="584 751 932 793">20.0 mg/L</td> <td data-bbox="932 751 1279 793">18 µg/L</td> </tr> </tbody> </table>	mg/L nitrite	Apparent µg/L chlorine	2.0 mg/L	3 µg/L	5.0 mg/L	5 µg/L	10.0 mg/L	7 µg/L	15.0 mg/L	16 µg/L	20.0 mg/L	18 µg/L
mg/L nitrite	Apparent µg/L chlorine												
2.0 mg/L	3 µg/L												
5.0 mg/L	5 µg/L												
10.0 mg/L	7 µg/L												
15.0 mg/L	16 µg/L												
20.0 mg/L	18 µg/L												
Ozone	Interferes at all levels												
Peroxides	May interfere												
Extreme sample pH or highly buffered samples	Adjust to pH 6–7												

¹ See [Optional Reagents and Apparatus on page 8](#).

² Samples treated with sodium arsenite for interferences will be hazardous waste as regulated by the Federal RCRA for arsenic (D004). Refer to the current MSDS for safe handling and disposal instructions.

Sample Collection, Storage, and Preservation

Analyze samples for chlorine immediately after collection. Many factors, including reactant concentrations, sunlight, pH, temperature and salinity influence decomposition of chlorine in water.

Avoid plastic containers since these may have a large chlorine demand. Pretreat glass sample containers to remove any chlorine demand by soaking in a dilute bleach solution (0.5 mL commercial bleach to 1 liter of deionized water) for at least 1 hour. Rinse thoroughly with deionized or distilled water. If sample containers are rinsed thoroughly with deionized or distilled water after use, only occasional pre-treatment is necessary.

A common error in testing for chlorine is failure to obtain a representative sample. If sampling from a tap, let the water flow for at least 5 minutes to ensure a representative sample. Let the container overflow with the sample several times, then cap the sample containers so there is no headspace (air) above the sample. Perform the chlorine analysis immediately.

Treating Analysis Labware

Glassware used in this test must be chlorine demand-free. Fill the 100-mL mixing cylinder and sample container with a dilute solution of chlorine bleach prepared by adding 1 mL of commercial bleach to 1 liter of water. Soak in this solution at least one hour. After soaking, rinse thoroughly with deionized water and allow to dry before use.

Treat the Pour-Thru Cell similarly with dilute bleach and let stand for several minutes. Rinse several times with deionized water.

Cleaning the Pour-Thru Cell

The Pour-Thru Cell may accumulate a buildup of colored reaction products, especially if the reacted solutions are allowed to remain in the cell for long periods after measurement. Remove the buildup by rinsing the cell with 5.25 N Sulfuric Acid* followed by several rinsings with deionized water.

Accuracy Check

Standard Additions Method (Sample Spike)

1. After reading test results, leave the sample cell (unspiked sample) in the instrument.
2. Press **OPTIONS>MORE**. Press **STANDARD ADDITIONS**. A keypad will appear. Enter the average chlorine concentration shown on the certificate enclosed with the chlorine voluette ampules. Multiply the mg/L concentration on the label by 1000 to enter this value as µg/L. Press **OK**.
3. A summary of the Standard Additions procedure will appear. Press **OK** to accept the values for standard concentration, sample volume, and spike volumes as shown. Press **Edit** to change these values. After values are accepted, the unspiked sample reading will appear in the top row. See the user manual for more information.
4. Snap the top off a Low Range Chlorine Voluette® Ampule Standard Solution, 25 to 30-mg/L (25,000 to 30,000 µg/L) Cl₂.
5. Prepare three sample spikes. Use the TenSette® Pipet to add 0.1, 0.2 and 0.3 mL of standard to three 50-mL samples, respectively. Swirl gently to mix.
6. Analyze each sample spike as described in the procedure above, starting with the 0.1 mL sample spike. Accept each standard additions reading by pressing **READ**. Each addition should reflect approximately 100% recovery.
7. After completing the sequence, press **GRAPH** to view the best-fit line through the standard additions data points, accounting for the matrix interferences. Press **IDEAL LINE** to view the relationship between the sample spikes and the "Ideal Line" of 100% recovery.

Summary of Method

This method is designed for clean water, low in color and turbidity. The main applications include monitoring for trace chlorine break-through of activated carbon beds and feedwater to reverse osmosis membranes or ion-exchange resins.

Several modifications to the normal DPD chlorine method are necessary to measure trace levels of chlorine. The Pour-Thru Cell must be used in the spectrophotometer. Liquid reagents are also required. The reproducible optics of the Pour-Thru Cell give more stable readings than is possible with movable sample cells, resulting in more stable measurements.

The reagents are packaged in ampules and sealed under argon gas to ensure stability. Use of liquid reagents eliminates any slight turbidity that might be caused by using powdered reagents. Due to the possible oxidation of the reagents (which could give a positive chlorine reading in the blank), a reagent blank must be determined at least once a day for each lot of reagent used. This reagent blank value is subtracted from the sample result and the corrected value is the actual chlorine concentration. Test results are measured at 515 nm.

* See [Optional Reagents and Apparatus on page 8](#).

Chlorine, Total ULR (2 to 500 µg/L as Cl₂)

Consumables and Replacement Items

Required Reagents

Description	Quantity/Test	Unit	Cat. No.
ULR Chlorine Reagent Set (approximately 20 tests), includes:			25630-00
ULR Chlorine Buffer Solution, 1.5-mL ampules	1 mL	20/pkg	24931-20
DPD Indicator Solution for ULR Chlorine, 1.5-mL ampules	1 mL	20/pkg	24932-20
Blanking Reagent for ULR Chlorine	1 mL	29 mL	24930-23

Required Apparatus

Description	Quantity/Test	Unit	Cat. No.
Adapter, for Multi-path and Pour-Thru cells	1	each	LZV585
Beaker, 250-mL	1	each	500-46H
Cylinder, graduated mixing, 50-mL	1	each	1896-41
Pipet, TenSette [®] , 0.1 to 1.0 mL	1	each	19700-01
Pipet Tips, for TenSette Pipet 19700-01	2	50/pkg	21856-96
Pour-Thru Cell Module Kit	1	each	59404-00

Recommended Standards

Description	Unit	Cat. No.
Chlorine Standard Solution, Voluette [®] Ampule, 25–30 mg/L, 2-mL	20/pkg	26300-20

Optional Reagents and Apparatus

Description	Cat. No.
Potassium Iodide, 30 g/L 100 mL	343-32
Sodium Arsenite, 5 g/L 100 mL	1047-32
Sulfuric Acid, 1 N 100 mL	1270-32
Sulfuric Acid, 5.25 N 1000 mL	2449-53



FOR TECHNICAL ASSISTANCE, PRICE INFORMATION AND ORDERING:
In the U.S.A. – Call toll-free 800-227-4224
Outside the U.S.A. – Contact the HACH office or distributor serving you.
On the Worldwide Web – www.hach.com; E-mail – techhelp@hach.com

HACH COMPANY
WORLD HEADQUARTERS
Telephone: (970) 669-3050
FAX: (970) 669-2932

Chlorine, Total

★Method 10014

DPD Method¹

Pour-Thru Cell and OriFlo™ Filtration

ULR (2 to 500 µg/L as Cl₂)

Scope and Application: For detecting trace levels of chlorine and chloramines in clean waters relatively free of color and turbidity; USEPA accepted for reporting for wastewater analysis².

¹ Adapted from *Standard Methods for the Examination of Water and Wastewater*.

² U.S. Patent 5,362,650 covers the procedure. U.S. Patent 5,549,816 covers the OriFlo™ Filtration System.



Test Preparation

Before starting the test:

Analyze samples immediately. Samples containing chlorine cannot be preserved for later analysis.

A reagent blank value for a combined lot of indicator/buffer reagent solutions should be determined at least once a day. If sample color or turbidity fluctuates frequently during the day, determine a reagent blank for each sample. Refer to [Treating Analysis Labware on page 7](#).

The reagent blank value is normally less than 5 µg/L. If the value is greater than 5 µg/L, an interfering substance may be present in the blanking water or the DPD Indicator may be degrading. If there is doubt about the reagents, repeat the reagent blank determination using chlorine-demand-free water for the sample. Blanks up to 5 µg/L may be used.

Use a new filter for each test. Using an unspecified filter may give low analysis results or inability to filter the required volume.

Ampules contain more than 1.0 mL of solution for ease of transfer. Discard excess reagent in the ampule.

Refer to the instrument User Manual for Pour-Thru cell and module assembly and installation.

Protect the Pour-Thru Cell from contamination when not in use by inverting a small beaker over the top of the glass funnel.

Collect the following items:

Quantity

ULR Chlorine Buffer Solution, 1.5-mL ampules	1 mL
DPD Indicator Solution for ULR Chlorine, 1.5-mL ampules	1 mL
Blanking Reagent for ULR Chlorine	1 mL
Membrane Filters, 3-micron, 25-mm	1
OriFlo Assembly	1
Beaker, 250 mL	1
Cylinder, graduated mixing, 50-mL.	1
Pipet, TenSette®, 0.1 to 1.0 mL	1
Pipet Tips	2
Pour-Thru Module and cell	1

Note: Reorder information for consumables and replacement items is on page 9.

Pour-Thru Cell

Method 8370

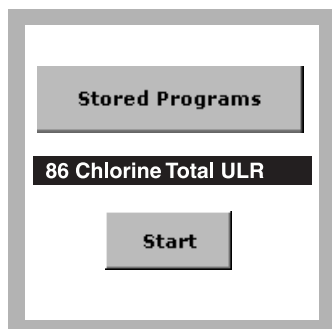

1. Select the test.

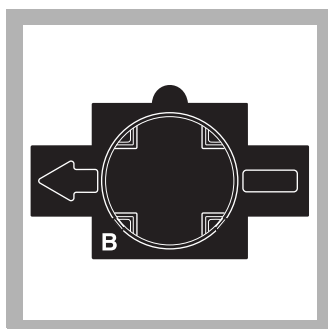

2. Insert Adapter B. Install the Pour-Thru Cell with the 1-inch (round) path in line with the adapter arrow.

Flush the Pour-Thru cell with 50 mL of deionized water.

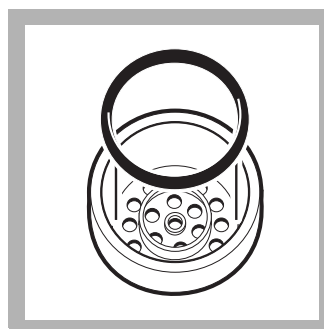

3. Unscrew the cap from the OriFlo™ plunger assembly. Be sure that the O-ring is properly seated in the cap.

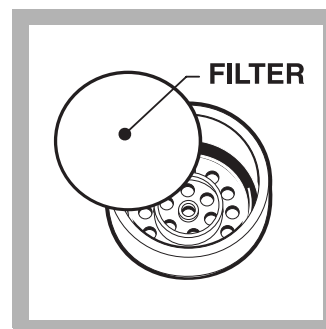

4. Install a new, 3-micron filter into the cap well. Wet the filter with a few drops of deionized water. Reassemble and hand-tighten the cap onto the plunger.

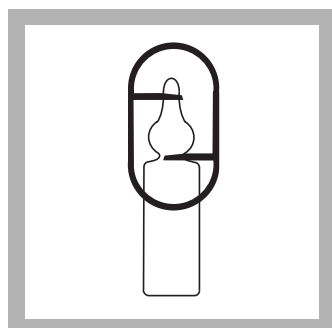

5. Break open one ULR Chlorine Buffer Solution Ampule.

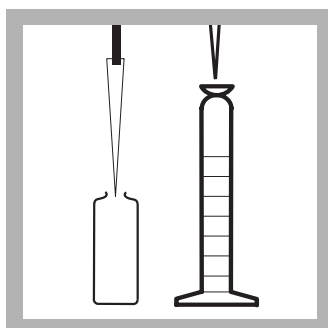

6. Using a TenSette® Pipet and a clean tip, transfer 1.0 mL of buffer from the ampule to a clean, treated 50-mL graduated mixing cylinder.

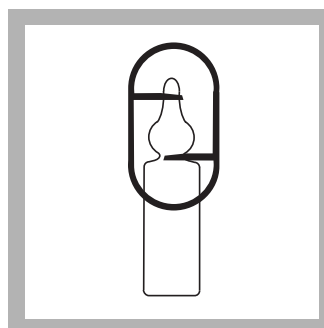

7. Break open one ampule of DPD Indicator Solution for Ultra Low Range Chlorine.

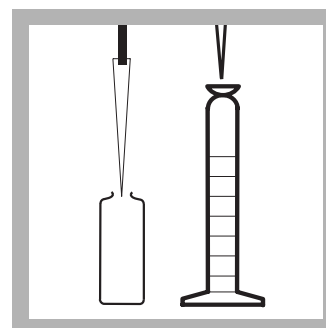

8. Using a TenSette Pipet and a clean tip, transfer 1.0 mL of indicator from the ampule to the graduated mixing cylinder. Swirl to mix.

Proceed to step 9 within one minute.

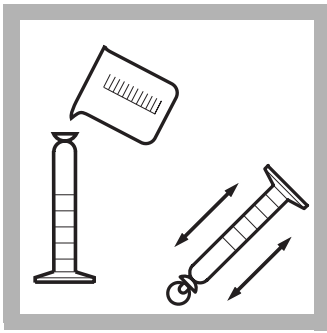

9. Prepared Sample:
Avoiding extra agitation, carefully fill the cylinder to the 50-mL mark with sample. Stopper the cylinder. Gently invert it twice to mix.

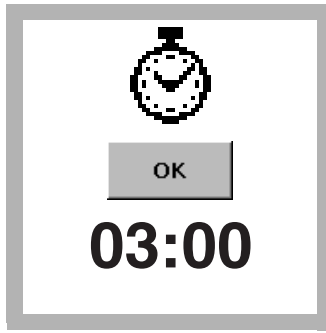

10. Press TIMER>OK.
A three-minute reaction time will begin. Perform steps 11–16 during this period.
Measure the reacted sample 3–6 minutes after mixing the sample and reagents. If less than three minutes elapses, the reaction with chloramines may be incomplete. A reading after six minutes may result in higher reagent blank values.

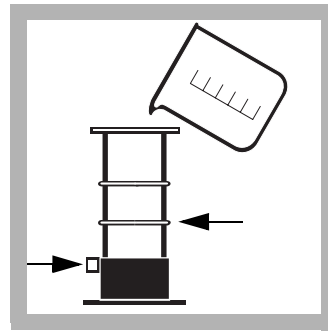

11. Push the valve button on the OriFlo™ barrel assembly to the “closed” position. Place the barrel assembly into its stand. Pour approximately 50 mL of the original sample into the barrel.
The lower ring on the barrel assembly represents about a 50-mL volume.

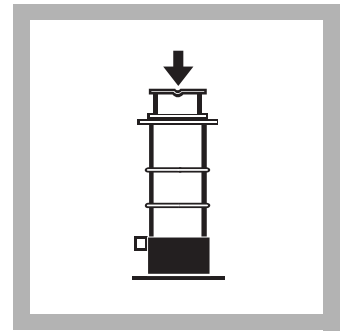

12. Insert the plunger into the barrel and slowly push the plunger down with even pressure, until the plunger is fully seated.

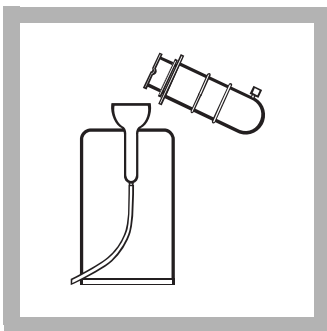

13. Pour the filtered sample from the plunger reservoir into the Pour-Thru Cell.

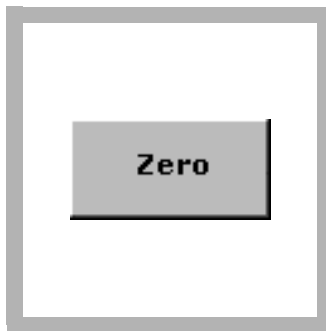

14. When the flow stops, press ZERO.
The display will show: 0 µg/L Cl₂.

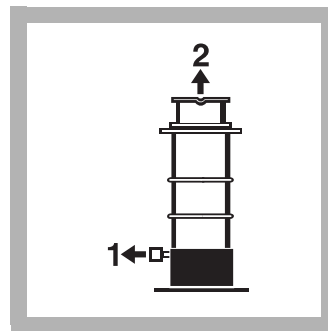

15. Pull the barrel valve button out to the “open” position. Pull the plunger up to separate it from the barrel assembly. Discard the remaining unfiltered sample.
A new membrane may be required for very turbid samples. Alternatively, use a second Quick Filter unit with a new membrane filter installed.

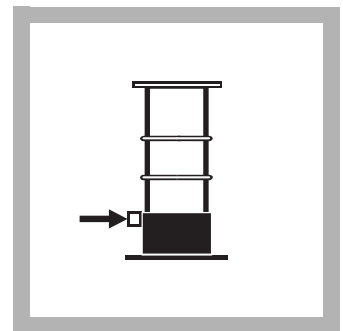

16. Push the barrel valve button to the “closed” position. Place the barrel assembly into its stand.

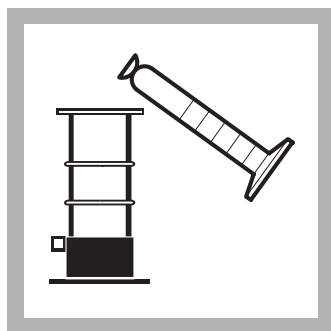

17. When the timer expires, pour the contents of the mixing cylinder into the barrel.

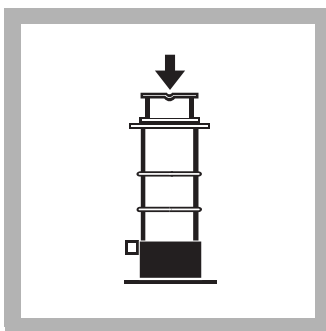

18. Insert the plunger into the barrel and slowly push the plunger down with even pressure, until the plunger is fully seated.

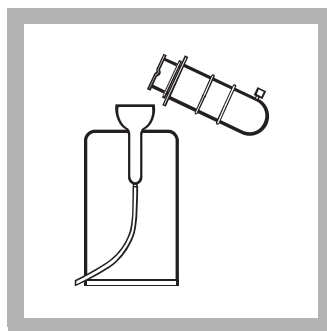

19. Pour the filtered, reacted sample from the plunger reservoir into the Pour-Thru Cell.

Press **READ**. Results are in µg/L chlorine.

If a dechlorinating agent (e.g., sulfite or sulfur dioxide) is present, the sample result, corrected for the reagent blank, will read "0" or a slightly negative value.

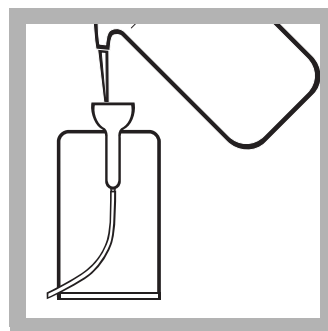

20. Flush the Pour-Thru Cell with at least 50-mL of deionized water immediately after use.

Subtract the reagent blank value ([Determining the Reagent Blank Value](#)) from the sample value obtained in step 19.

Determining the Reagent Blank Value

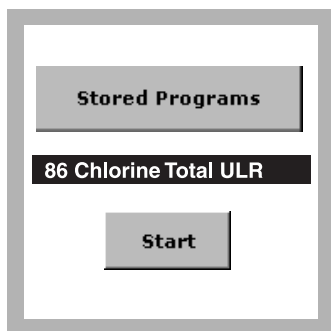

1. Select the test.

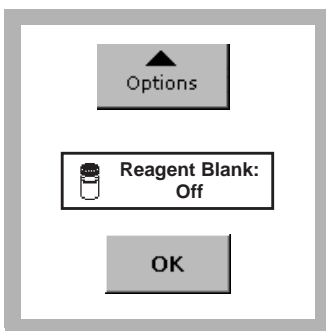

2. Make sure that the reagent blank setting is off.

Press **OPTIONS>MORE>REAGENT BLANK>OFF**. See the user manual for information.

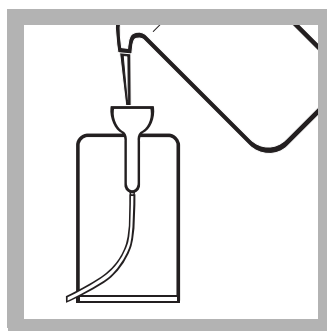

3. Insert Adapter B. Install the Pour-Thru module and cell with the 1-inch (round) path in line with the arrow on the adapter.

Flush the Pour-Thru cell with 50 mL of deionized water.

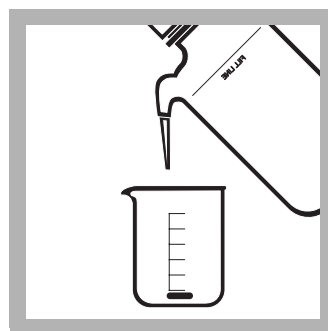

4. Collect about 100 mL of deionized or tap water in a clean, 250-mL beaker.

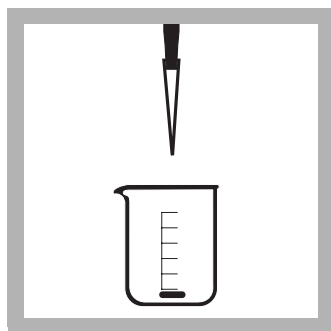

5. Using a TenSette Pipet, add 1.0 mL of Blanking Reagent to the beaker. Swirl several times to mix.

The Blanking Reagent removes chlorine and chloramines from the water.

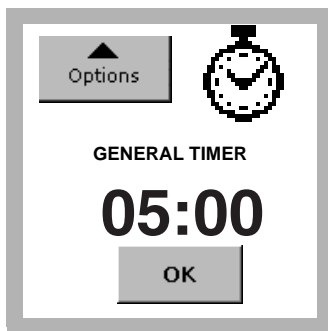

6. Press **OPTIONS>MORE>TIMER>GENERAL TIMER**.

Set a 5-minute timer and press **OK**. A five-minute dechlorination period will begin.

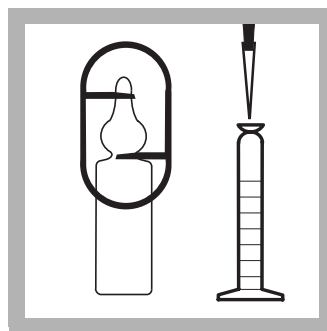

7. After the timer expires, break open one ampule of ULR Chlorine Buffer Solution. Using a TenSette Pipet and clean tip, transfer 1.0 mL of buffer from the ampule to a clean 50-mL mixing graduated cylinder.

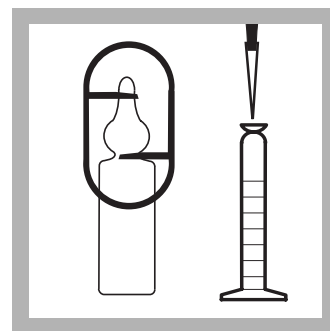

8. Break open one ampule of DPD Indicator Solution for Ultra Low Range Chlorine. Using a TenSette Pipet and a clean tip, transfer 1.0 mL of indicator from the ampule to the cylinder. Swirl to mix the reagents. Proceed to step 9 within one minute.

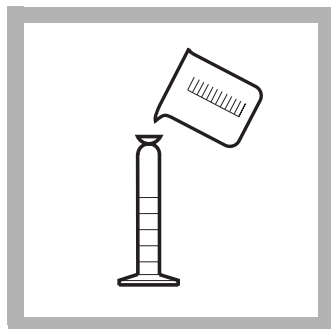

9. Fill the cylinder to the 50-mL mark with dechlorinated water from step 5. Cap and invert twice to mix. Save the remaining water for step 11.

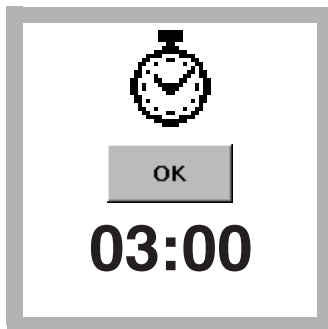

10. Press **TIMER>OK**. A three-minute reaction time will begin.

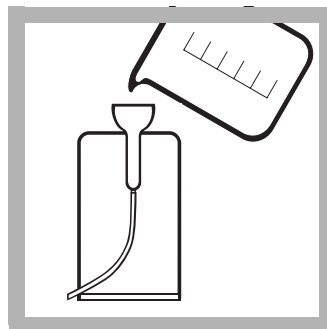

11. During the reaction period, flush the Pour-Thru Cell with the remainder of original dechlorinated water from step 9.

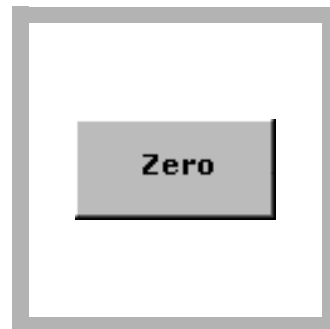

12. When the flow stops, press **ZERO**.

The display will show: 0 µg/L Cl₂.

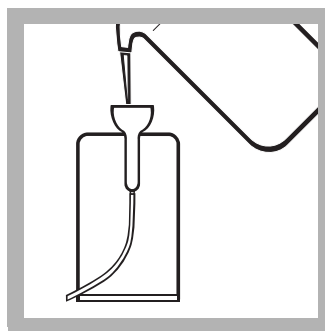
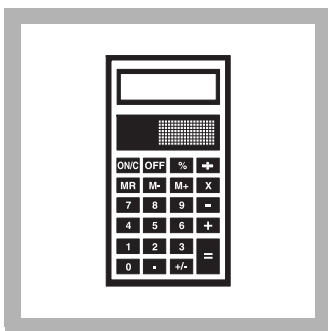
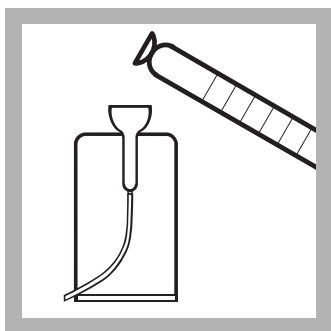

13. When the timer expires, introduce the contents of the cylinder into the Pour-Thru Cell. When the flow stops, press **READ**. Results are in µg/L chlorine.

14. Use this value to correct the sample result obtained in this procedure. See the user manual for details on saving the reagent blank value.

15. Flush the Pour-Thru Cell with at least 50-mL of deionized water immediately after use.

Interferences

Table 1 Interfering Substances and Levels

Interfering Substance	Interference Levels and Treatments												
Bromine, Br ₂	Interferes at all levels.												
Chlorine Dioxide, ClO ₂	Interferes at all levels												
Chloramines, organic	May interfere												
Copper, Cu ²⁺	Greater than 1000 µg/L												
Iodine, I ₂	Interferes at all levels.												
Manganese, oxidized (Mn ⁴⁺ , Mn ⁷⁺) or Chromium, oxidized (Cr ⁶⁺)	<ol style="list-style-type: none"> Adjust sample pH to 6–7 with 1.000 N Sulfuric Acid¹. Add 9 drops Potassium Iodide (30 g/L)¹ to an 80-mL sample. Mix and wait 1 minute. Add 9 drops Sodium Arsenite^{1, 2} (5 g/L) and mix. Analyze the treated sample as described in the procedure above. Subtract the result of this test from the original analysis to obtain the correct concentration. 												
Nitrite, NO ₂ ⁻ (uncommon in clean waters)	<table border="1"> <thead> <tr> <th>mg/L nitrite</th> <th>Apparent µg/L chlorine</th> </tr> </thead> <tbody> <tr> <td>2.0 mg/L</td> <td>3 µg/L</td> </tr> <tr> <td>5.0 mg/L</td> <td>5 µg/L</td> </tr> <tr> <td>10.0 mg/L</td> <td>7 µg/L</td> </tr> <tr> <td>15.0 mg/L</td> <td>16 µg/L</td> </tr> <tr> <td>20.0 mg/L</td> <td>18 µg/L</td> </tr> </tbody> </table>	mg/L nitrite	Apparent µg/L chlorine	2.0 mg/L	3 µg/L	5.0 mg/L	5 µg/L	10.0 mg/L	7 µg/L	15.0 mg/L	16 µg/L	20.0 mg/L	18 µg/L
mg/L nitrite	Apparent µg/L chlorine												
2.0 mg/L	3 µg/L												
5.0 mg/L	5 µg/L												
10.0 mg/L	7 µg/L												
15.0 mg/L	16 µg/L												
20.0 mg/L	18 µg/L												

Table 1 Interfering Substances and Levels (continued)

Interfering Substance	Interference Levels and Treatments
Ozone	Interferes at all levels.
Peroxides	May interfere
Extreme sample pH or highly buffered samples	Adjust to pH 6–7

¹ See [Optional Reagents and Apparatus on page 9](#).

² Samples treated with sodium arsenite for interferences will be hazardous waste as regulated by the Federal RCRA for arsenic (D004). Refer to the current MSDS for safe handling and disposal instructions.

Sample Collection, Storage, and Preservation

Analyze samples for chlorine immediately after collection. Chlorine is a strong oxidizing agent and it is unstable in natural waters. It reacts rapidly with various inorganic compounds and more slowly oxidizes organic compounds. Many factors, including reactant concentrations, sunlight, pH, temperature and salinity influence decomposition of chlorine in water.

Avoid plastic containers since these may have a large chlorine demand. Pretreat glass sample containers to remove any chlorine demand by soaking in a dilute bleach solution (1 mL commercial bleach to 1 liter of deionized water) for at least 1 hour. Rinse thoroughly with deionized or distilled water. If sample containers are rinsed thoroughly with deionized or distilled water after use, only occasional pre-treatment is necessary.

A common error in testing for chlorine is not obtaining a representative sample. If sampling from a tap, let the water flow for at least 5 minutes to ensure a representative sample. Let the container overflow with the sample several times, then cap the sample containers so there is no head space (air) above the sample. Perform the chlorine analysis immediately.

Treating Analysis Labware

Glassware used in this test must be chlorine demand-free. Fill the 100-mL mixing cylinder and sample container with a dilute solution of chlorine bleach prepared by adding 1 mL of commercial bleach to 1 liter of water. Soak in this solution at least one hour. After soaking, rinse thoroughly with deionized water and allow to dry before use.

Treat the Pour-Thru Cell similarly with dilute bleach and let stand for several minutes. Rinse several times with deionized water.

Cleaning the Pour-Thru Cell

The Pour-Thru Cell may accumulate a buildup of colored reaction products, especially if the reacted solutions are allowed to remain in the cell for long periods after measurement. Remove the buildup by rinsing the cell with 5.25 N Sulfuric Acid* followed by several rinsings with deionized water.

* See [Optional Reagents and Apparatus on page 9](#).

Accuracy Check

Standard Additions Method (Sample Spike)

1. After reading test results, leave the sample cell (unspiked sample) in the instrument.
2. Press **OPTIONS>MORE**. Press **STANDARD ADDITIONS**. A keypad will appear. Enter the average chlorine concentration shown on the certificate enclosed with the chlorine voluette ampules. Multiply the mg/L value from the label by 1000, to enter this as µg/L. Press **OK**.
3. A summary of the Standard Additions procedure will appear. Press **OK** to accept the values for standard concentration, sample volume, and spike volumes as shown. Press **Edit** to change these values. After values are accepted, the unspiked sample reading will appear in the top row. See the user manual for more information.
4. Snap the top off a Low Range Chlorine Voluette® Ampule Standard Solution, 25 to 30-mg/L (25,000 to 30,000 µg/L).
5. Prepare three sample spikes. Use the TenSette® Pipet to add 0.1, 0.2, and 0.3 mL of standard to three 50-mL samples, respectively. Swirl gently to mix.
6. Analyze each sample spike as described in the procedure above, starting with the 0.1 mL sample spike. Accept each standard additions reading by pressing **READ**. Each addition should reflect approximately 100% recovery.
7. After completing the sequence, press **GRAPH** to view the best-fit line through the standard additions data points, accounting for the matrix interferences. Press **IDEAL LINE** to view the relationship between the sample spikes and the “Ideal Line” of 100% recovery.

Summary of Method

It is essential that interfering sample turbidity is removed using a 3-micron membrane filter. To avoid chlorine loss, the filtration is done after reacting the DPD with the chlorine in the sample. The filter used has been specifically selected to avoid retention of the colored product. Sample color is compensated by zeroing the spectrophotometer on a filtered sample.

Several modifications to the normal DPD chlorine method are necessary to measure trace levels of chlorine. The Pour-Thru Cell must be used in the spectrophotometer. Liquid reagents are also required. The reproducible optics of the Pour-Thru Cell give more stable readings than is possible with movable sample cells, resulting in more stable measurements.

The reagents are packaged in ampules and sealed under argon gas to ensure stability. Use of liquid reagents eliminates any slight turbidity that might be caused by using powdered reagents. Due to the possible oxidation of the reagents (which could give a positive chlorine reading in the blank), a reagent blank must be determined at least once a day for each lot of reagent used. This reagent blank value is subtracted from the sample result and the corrected value is the actual chlorine concentration. Test results are measured at 515 nm.

Consumables and Replacement Items

Required Reagents

Description	Quantity/Test	Unit	Cat. No.
ULR Chlorine Reagent Set (approximately 20 tests), includes:	—	—	25630-00
ULR Chlorine Buffer Solution, 1.5-mL ampules	1 mL	20/pkg	24931-20
DPD Indicator Solution for ULR Chlorine, 1.5-mL ampules	1 mL	20/pkg	24932-20
Blanking Reagent for ULR Chlorine	1 mL	29 mL	24930-23

Required Apparatus

Description	Quantity/Test	Unit	Cat. No.
ULR Chlorine Apparatus Set, includes:	—	—	25956-00
Membrane Filters, 3-micron, 25-mm	1	25/pkg	25940-25
OriFlo™ Assembly	1	each	49660-00
Adapter, for Multi-path and Pour-Thru cells	1	each	LZV585
Beaker, 250-mL	1	each	500-46H
Cylinder, graduated mixing, 50-mL	1	each	1896-41
Pipet, TenSette®, 0.1 to 1.0 mL	1	each	19700-01
Pipet Tips, for TenSette Pipet 19700-01	2	50/pkg	21856-96
Pour-Thru Cell Module Kit	1	each	59404-00

Recommended Standards

Description	Unit	Cat. No.
Chlorine Standard Solution, Voluette® Ampule, 25–30 mg/L, 2-mL	20/pkg	26300-20

Optional Reagents and Apparatus

Description	Cat. No.
Potassium Iodide, 30 g/L 100 mL	343-32
Sodium Arsenite, 5 g/L 100 mL	1047-32
Sulfuric Acid, 1 N 100 mL	1270-32
Sulfuric Acid, 5.25 N 100 mL	2449-53



FOR TECHNICAL ASSISTANCE, PRICE INFORMATION AND ORDERING:

In the U.S.A. – Call toll-free 800-227-4224
Outside the U.S.A. – Contact the HACH office or distributor serving you.
On the Worldwide Web – www.hach.com; E-mail – techhelp@hach.com

HACH COMPANY
WORLD HEADQUARTERS
Telephone: (970) 669-3050
FAX: (970) 669-2932

Chromium, Hexavalent

★Method 8023

1,5-Diphenylcarbohydrazide Method¹

Powder Pillows or AccuVac[®] Ampuls

(0.010 to 0.700 mg/L Cr⁶⁺)

Scope and Application: For water and wastewater;
USEPA accepted for reporting for wastewater analysis²

¹ Adapted from *Standard Methods for the Examination of Water and Wastewater*.

² Procedure is equivalent to USGS method 1-1230-85 for wastewater.



Test Preparation

Before starting the test:

For more accurate results, determine a reagent blank value for each new lot of reagent. Follow the procedure using deionized water instead of the sample.

At high chromium levels, a precipitate will form. Sample dilution may be necessary.

The final samples are highly acidic. Neutralize to pH 6–9 with Sodium Hydroxide Standard Solution and refer to reagent MSDS sheets for disposal information.

Collect the following items:

Quantity

Powder Pillow Test:	
ChromaVer [®] 3 Chromium Reagent Powder Pillows	1
Sample cells, 1-in. square, 10-mL	2
AccuVac Test:	
Collect at least 40 mL of sample in a 50-mL beaker	40 mL
ChromaVer [®] 3 AccuVac [®] Ampuls	1
Beaker, 50-mL (AccuVac test)	1
Sample cell, 10-mL round, with cap	1

Note: Reorder information for consumables and replacement items is on page 6.

Powder Pillows

Method 8023



1. Press **STORED PROGRAMS**.

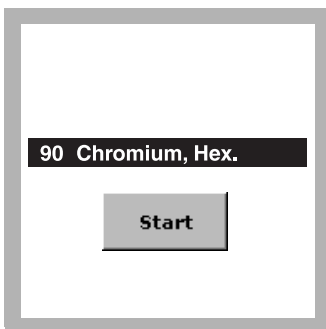

2. Select the test.

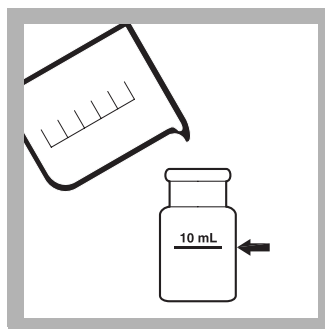

3. Fill a square sample cell with 10 mL of sample.

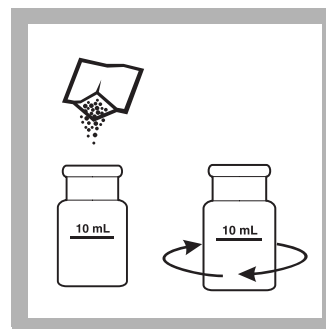

4. **Prepared Sample:** Add the contents of one ChromaVer® 3 Reagent Powder Pillow to the sample cell. Swirl to mix.

A purple color will form if hexavalent chromium is present.

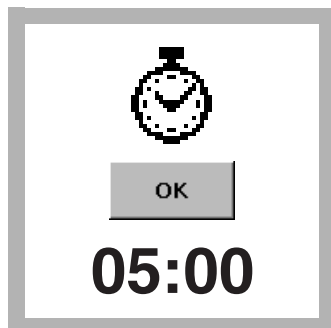

5. Press **TIMER>OK**.
A five-minute reaction period will begin.

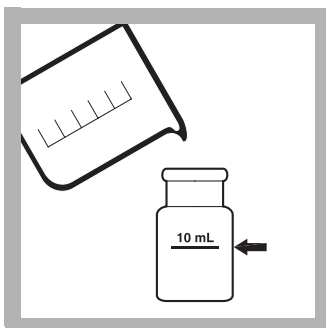

6. **Blank Preparation:** Fill a second square sample cell with 10 mL of sample.



7. When the timer expires, insert the blank into the cell holder with the fill line facing right.
Press **ZERO**. The display will show:

0.000 mg/L Cr⁶⁺

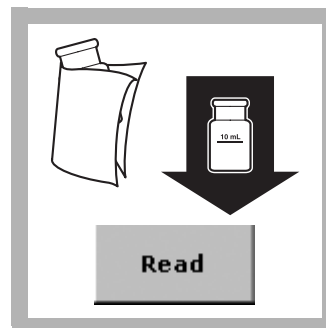

8. Insert the prepared sample into the cell holder with the fill line facing right.
Press **READ**. Results are in mg/L Cr⁶⁺.

AccuVac Ampul[®]

Method 8023

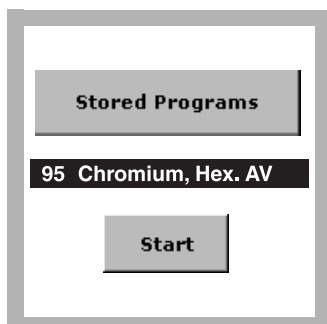

1. Select the test.

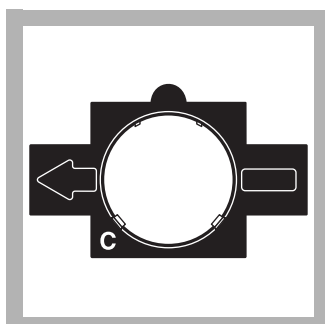

2. Insert Adapter C.

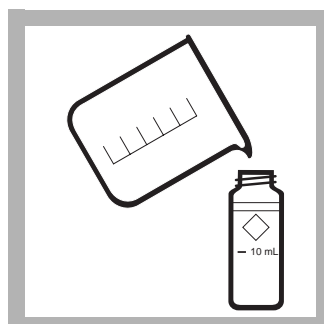

3. **Blank Preparation:**
Fill a round sample cell with 10-mL of sample.

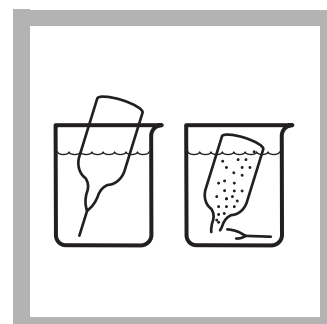

4. **Prepared Sample:**
Fill a ChromaVer 3 Reagent AccuVac[®] Ampul with sample from the beaker. Keep the tip immersed while the Ampul fills completely.

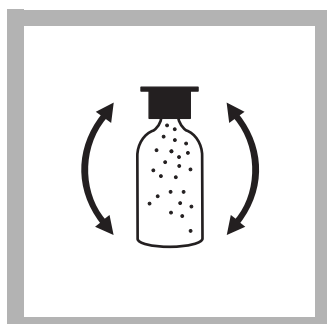

5. Quickly invert the Ampul several times to mix. Wipe off any liquid or fingerprints.

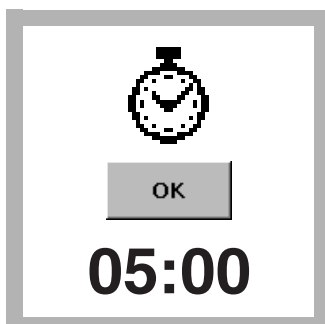

6. Press **TIMER>OK**.
A five-minute reaction period will begin.

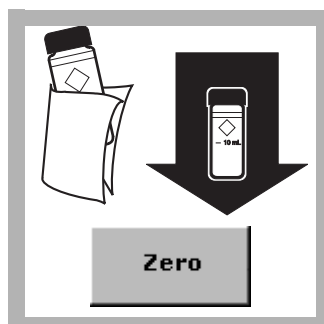

7. When the timer expires, insert the blank into the cell holder.
Press **ZERO**. The display will show:

0.000 mg/L Cr⁶⁺

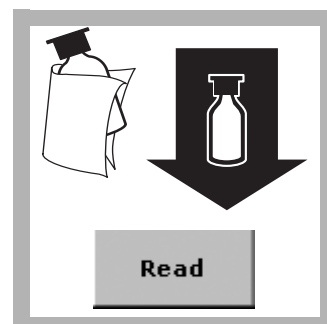

8. Insert the prepared sample into the cell holder.
Press **READ**. Results are in mg/L Cr⁶⁺.

Interferences

Table 1 Interfering Substances and Levels

Interfering Substance	Interference Levels and Treatments
Iron	May interfere above 1 mg/L
Mercurous & Mercuric Ions	Interfere slightly
pH	Highly buffered samples or extreme sample pH may exceed the buffering capacity of the reagents and require sample pretreatment.
Vanadium	May interfere above 1 mg/L. Allow 10 minutes for the reaction period before reading.
Turbidity	For turbid samples, treat the blank with the contents of one Acid Reagent Powder Pillow ¹ . This will ensure that any turbidity dissolved by the acid in the ChromaVer 3 Chromium Reagent will also be dissolved in the blank.

¹ See [Optional Reagents and Apparatus on page 6](#)

Sample Collection, Preservation, and Storage

Collect samples in a cleaned glass or plastic container. Store at 4 °C (39 °F) up to 24 hours. Samples must be analyzed within 24 hours.

Accuracy Check

Standard Additions Method (Sample Spike)

1. After reading test results, leave the sample cell, or AccuVac Ampul (unspiked sample) in the instrument. Verify the chemical form.
2. Press **OPTIONS>MORE**. Press **STANDARD ADDITIONS**. A summary of the standard additions procedure will appear.
3. Press **OK** to accept the default values for standard concentration, sample volume, and spike volumes. Press **EDIT** to change these values. After values are accepted, the unspiked sample reading will appear in the top row. See the user manual for more information.
4. Snap the neck off a Chromium Voluette[®] Ampule Standard, 12.5 mg/L Cr⁶⁺.
5. For analysis using powder pillows, use the TenSette[®] Pipet to add 0.1 mL, 0.2 mL, and 0.3 mL of standard, respectively to three 25-mL samples and mix thoroughly. Transfer 10 mL of each solution into a 10-mL sample cell and analyze as described above.

Note: For AccuVac Ampuls, fill three mixing cylinders* with 50-mL of sample and spike with 0.2 mL, 0.4 mL, and 0.6 mL of standard. Transfer 40 mL from each of the three mixing cylinders to three 50-mL beakers. Analyze each standard addition sample as described in the procedure above.

6. Accept each standard additions reading by pressing **READ**. Each addition should reflect approximately 100% recovery.
7. After completing the sequence, press **GRAPH** to view the best-fit line through the standard additions data points, accounting for matrix interferences. Press **IDEAL LINE** to view relationships between the sample spikes and the "Ideal Line" of 100% recovery.

*See [Optional Reagents and Apparatus on page 6](#).

Standard Solution Method

Prepare a 0.50-mg/L Cr⁶⁺ standard solution daily, as follows:

1. Using a 5.00 mL pipet transfer 5.00 mL of Hexavalent Chromium Standard Solution, 50 mg/L, into a Class A 500-mL volumetric flask.
2. Perform the hexavalent chromium procedure as described above.
3. Dilute to the mark with deionized water. Perform the test procedure as described above.
4. To adjust the calibration curve using the reading obtained with the standard solution, press **OPTIONS>MORE** on the current program menu. Press **STANDARD ADJUST**.
5. Press **ON**. Press **ADJUST** to accept the displayed concentration. If an alternate concentration is used, press the number in the box to enter the actual concentration, then press **OK**. Press **ADJUST**.

Summary of Method

Hexavalent chromium is determined by the 1,5-Diphenylcarbohydrazide method using a single dry powder formulation called ChromaVer 3 Chromium Reagent. This reagent contains an acidic buffer combined with 1,5-Diphenylcarbohydrazide, which reacts to give a purple color when hexavalent chromium is present. Test results are measured at 540 nm.

Chromium, Hexavalent (0.010 to 0.700 mg/L Cr⁶⁺)

Consumables and Replacement Items

Required Reagents

Description	Quantity/Test	Unit	Cat. No.
ChromaVer [®] 3 Chromium Reagent Powder Pillows	1	100/pkg	12710-99
OR			
ChromaVer [®] 3 AccuVac [®] Ampuls	1	25/pkg	25050-25
Deionized Water	varies	4 L	272-56

Required Apparatus (Powder Pillows)

Description	Quantity/Test	Unit	Cat. No.
Sample Cells, 1-inch square, 10 mL, matched pair	2	2/pkg	24954-02

Required Apparatus (AccuVac)

Description	Quantity/Test	Unit	Cat. No.
Adapter, 1-inch round, for AccuVac Ampuls	1	each	LZV584
Beaker, 50-mL	1	each	500-41H
Sample Cell, 10-mL, with cap	1	each	21228-00

Recommended Standards

Description	Unit	Cat. No.
Chromium, Hexavalent Standard Solution, 10-mL Voluette [®] Ampules, 12.5-mg/L Cr ⁶⁺	16/pkg	14256-10
Chromium, Hexavalent Standard Solution, Chromium, Standard Solution, 50.0-mg/L Cr ⁶⁺	100 mL	810-42H

Optional Reagents and Apparatus

Description	Cat. No.
Acid Reagent Powder Pillow	2126-99
Flask, volumetric, Class A, 500-mL	14574-49
Pipet, 5.00 mL	14515-37
Sodium Hydroxide Standard Solution	2450-26



FOR TECHNICAL ASSISTANCE, PRICE INFORMATION AND ORDERING:
In the U.S.A. – Call toll-free 800-227-4224
Outside the U.S.A. – Contact the HACH office or distributor serving you.
On the Worldwide Web – www.hach.com; E-mail – techhelp@hach.com

HACH COMPANY
WORLD HEADQUARTERS
Telephone: (970) 669-3050
FAX: (970) 669-2932

Chromium, Total

Method 8024

Alkaline Hypobromite Oxidation Method^{1, 2}

Powder Pillows

(0.01 to 0.70 mg/L)

Scope and Application: For water and wastewater

¹ Adapted from *Standard Methods for the Examination of Water and Wastewater*

² This procedure is equivalent to Standard Method 3500-CRD for wastewater.



Test Preparation

Before starting the test:

For more accurate results, determine a reagent blank value for each new lot of reagent. Follow the procedure using deionized water instead of the sample. Subtract the reagent blank value from the final results or perform a reagent blank adjust.

Prepare a boiling water bath for step 5. Use finger cots to handle hot sample cells.

Collect the following items:

Quantity

Acid Reagent Powder Pillows	1
ChromaVer® 3 Chromium Reagent Powder Pillows	1
Chromium 1 Reagent Powder Pillows	1
Chromium 2 Reagent Powder Pillows	1
Hot Plate	1
Water Bath and Rack	1
Finger Cots	varies
Sample Cells, 1-inch square	2
Sample Cell, 1-inch round, 10–20–25 mL, with cap	1

Note: Reorder information for consumables and replacement items is on page 5.

Powder Pillows

Method 8024

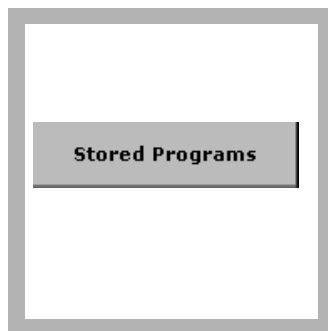

1. Press **STORED PROGRAMS**.

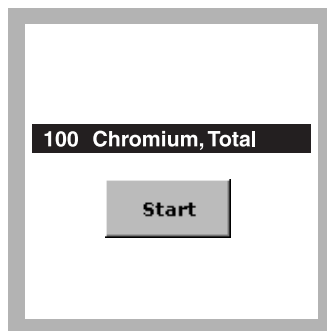

2. Select the test.

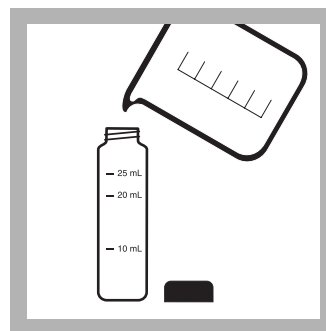

3. Fill a 25-mL sample cell with 25 mL of sample.

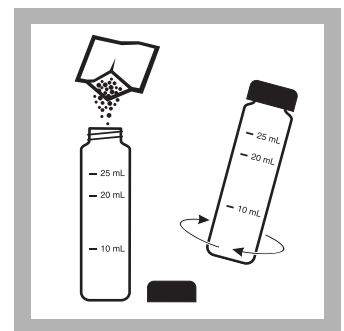

4. **Prepared Sample:** Add the contents of one Chromium 1 Reagent Powder Pillow. Swirl to mix.

Chromium, Total (0.01 to 0.70 mg/L)

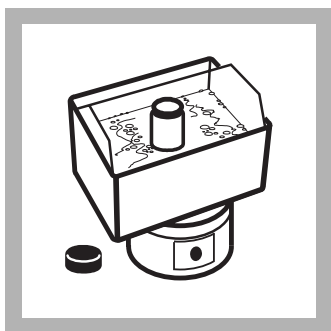

5. Insert the prepared sample into a boiling water bath.

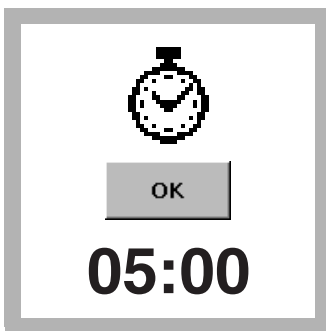

6. Press **TIMER>OK**.
A five-minute reaction period will begin.

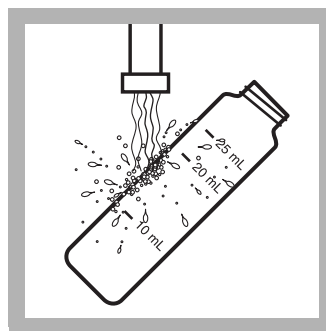

7. When the timer expires, remove the prepared sample. Using running water, cool the cell to 25 °C.

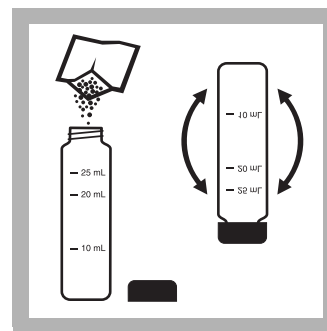

8. Remove cap and add the contents of one Chromium 2 Reagent Powder Pillow. Cap and invert to mix.

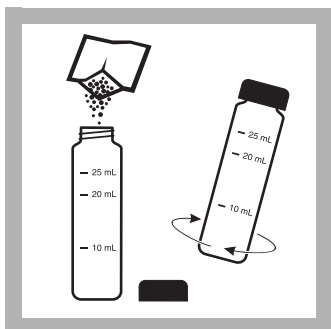

9. Add the contents of one Acid Reagent Powder Pillow. Swirl to mix.

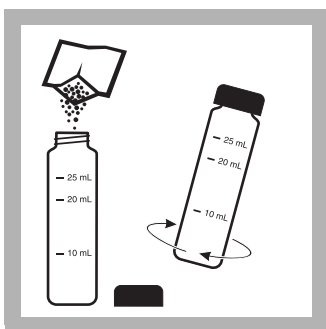

10. Add the contents of one ChromaVer 3 Chromium Reagent Powder Pillow. Swirl to mix.

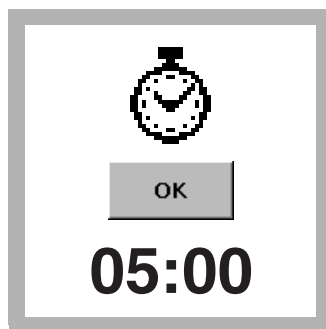

11. Press **TIMER>OK**.
A five-minute reaction period will begin.

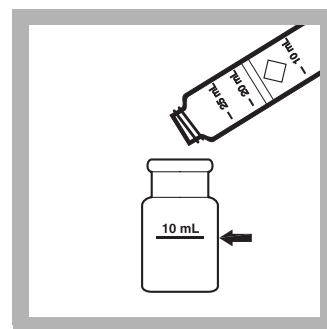

12. While the sample is reacting, pour 10 mL from the mixing bottle into a square sample cell.

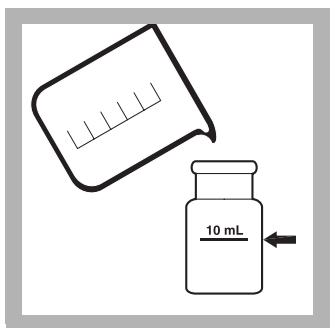

13. **Blank Preparation:**
When the timer expires, fill another sample cell with 10 mL of sample.



14. Wipe the blank and insert it into the cell holder with the fill line facing right.

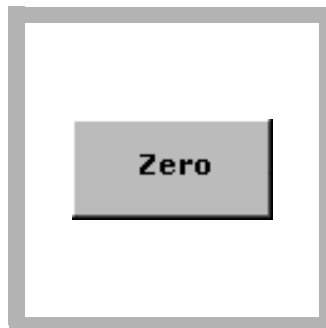

15. Press **Zero**.
The display will show:
0.00 mg/L Cr



16. Wipe the prepared sample and insert it into the cell holder with the fill line facing right.
Press **READ**. Results are in mg/L Cr.

Interferences

Table 1 Interfering Substances and Levels

Interfering Substance	Interference Levels and Treatments
Highly buffered samples or extreme sample pH	May exceed the buffering capacity of the reagents and require sample pretreatment.
Organic material	May inhibit complete oxidation of trivalent chromium. If high levels of organic material are present, digestion may be required. Perform the analysis as described in this procedure on the digested sample.
Turbidity	For turbid samples, treat the 25-mL blank and the sample the same during steps 3–9.

Sample Collection, Storage, and Preservation

Collect samples in acid-washed glass or plastic containers. To preserve samples, adjust the pH to 2 or less with nitric acid. This requires approximately 2 mL per liter of the acid. Store preserved samples at room temperature up to six months. Adjust the pH to about 4 with 5.0 N Sodium Hydroxide before analysis. Correct the test result for volume additions.

Accuracy Check

Standard Additions Method (Sample Spike)

1. After reading test results, leave the sample cell (unspiked sample) in the instrument. Verify the chemical form.
2. Press **OPTIONS>MORE**. Press **STANDARD ADDITIONS**. A summary of the standard additions procedure will appear.
3. Press **OK** to accept the default values for standard concentration, sample volume, and spike volumes. Press **EDIT** to change these values. After values are accepted, the unspiked sample reading will appear in the top row. See the user manual for more information.
4. Snap the neck off a Trivalent Chromium Voluette® Ampule Standard, 12.5-mg/L as Cr³⁺.
5. Prepare three sample spikes. Fill three mixing cylinders with 25 mL of sample. Use the TenSette® Pipet to add 0.1 mL, 0.2 mL, and 0.3 mL of standard, respectively, to each sample and mix thoroughly.
6. Analyze each sample spike as described in the procedure above, starting with the 0.1 mL sample spike. Accept each standard additions reading by pressing **READ**. Each addition should reflect approximately 100% recovery.
7. After completing the sequence, press **GRAPH** to view the best-fit line through the standard additions data points, accounting for matrix interferences. Press **IDEAL LINE** to view relationships between the sample spikes and the "Ideal Line" of 100% recovery.

Standard Solution Method

Prepare a 0.50-mg/L trivalent chromium standard as follows:

1. Dilute 5.00 mL of Trivalent Chromium Standard Solution, 50-mg/L as Cr^{3+} , to 500 mL with deionized water. Prepare this solution daily.
2. To adjust the calibration curve using the reading obtained with the standard solution, press **OPTIONS>MORE** on the current program menu. Press **STANDARD ADJUST**.
3. Press **ON**. Press **ADJUST** to accept the displayed concentration. If an alternate concentration is used, press the number in the box to enter the actual concentration, then press **OK**. Press **ADJUST**.

Summary of Method

Trivalent chromium in the sample is oxidized to the hexavalent form by hypobromite ion under alkaline conditions. The sample is acidified. The total chromium content is determined by the 1,5-Diphenylcarbohydrazide method. Determine trivalent chromium by subtracting the results of a separate hexavalent chromium test from the results of the total chromium test.

Test results are measured at 540 nm.

Consumables and Replacement Items

Required Reagents

Description	Quantity/Test	Unit	Cat. No.
Total Chromium Reagent Set (100 tests), includes:	—	—	22425-00
Acid Reagent Powder Pillows	1	100/pkg	2126-99
ChromaVer® 3 Chromium Reagent Powder Pillows	1	100/pkg	12066-99
Chromium 1 Reagent Powder Pillows	1	100/pkg	2043-99
Chromium 2 Reagent Powder Pillows	1	100/pkg	2044-99

Required Apparatus

Description	Quantity/Test	Unit	Cat. No.
Sample Cells, 1-inch square, 10 mL, matched pair	2	2/pkg	24954-02
Sample Cell, 10-20-25 mL, with cap	1	each	24019-06
Hot plate, 3½-inch diameter, 120 VAC, 50/60 Hz	1	each	12067-01
OR			
Hot Plate, 4-inch diameter, 240 VAC, 50/60 Hz	1	each	12067-02
Water Bath and Rack	1	each	1955-55

Recommended Standards

Description	Unit	Cat. No.
Chromium, Trivalent, Standard Solution, 50-mg/L Cr ³⁺	100 mL	14151-42
Chromium, Trivalent, Standard Sol., 12.5-mg/L Cr ³⁺ , Voluette Ampule®, 10-mL	16/pkg	14257-10

Optional Reagents and Apparatus

Description	Cat. No.
Acid Reagent Powder Pillow	2126-99
Finger Cots	14647-02
Flask, volumetric, Class A, 500-mL	14574-49
Pipette, volumetric, Class A, 5.00 mL	14515-37



FOR TECHNICAL ASSISTANCE, PRICE INFORMATION AND ORDERING:

In the U.S.A. – Call toll-free 800-227-4224
Outside the U.S.A. – Contact the HACH office or distributor serving you.
On the Worldwide Web – www.hach.com; E-mail – techhelp@hach.com

HACH COMPANY
WORLD HEADQUARTERS
Telephone: (970) 669-3050
FAX: (970) 669-2932

Chromium, Total and Hexavalent

Method 10218 (Chromium, Hexavalent)

Method 10219 (Chromium, Total)

TNTplus™ 854

1,5-Diphenylcarbohydrazide Method

(0.03 to 1.00 mg/L Cr)

Scope and Application: For wastewater and process analysis



Test Preparation

Before starting the test:

Important Note: Install the light shield in Cell Compartment #2 before performing this test.

Recommended sample pH is 3–9.

Recommended sample and reagent temperature is 15–35 °C (59–95 °F). Incorrect results may be obtained if test is not performed at the recommended temperature.

Recommended reagent storage is 2–8 °C (35.6–46.4 °F).

The concentration of trivalent chromium is obtained mathematically from the difference between chromium (total) and chromium VI (hexavalent).

TNTplus methods are activated from the Main Menu screen when the sample vial is inserted into the sample cell holder.

Collect the following items:

Quantity

Chromium, Total and Hexavalent, TNT854 Reagent set	1
Light Shield	1
Pipettor for 2.0 mL sample	1
Pipettor Tips	varies
Test Tube Rack	1

Note: Reorder information for consumables and replacement items is on page 7.

TNTplus Chromium, Total

Method 10219

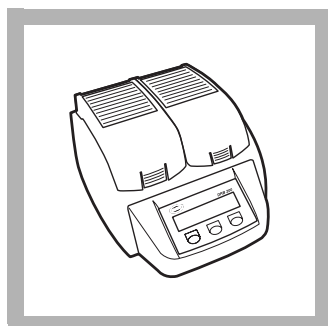

1. Turn on the DRB200 Reactor. Preheat to 100 °C.

Note: For DRB200 Reactors with 16-mm wells, insert a 16-mm to 13-mm adapter sleeve into each well **before** turning on the reactor.

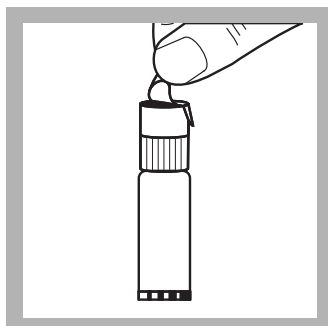

2. Carefully remove the protective foil lid from the DosiCap™ Zip. Unscrew the cap from the vial.

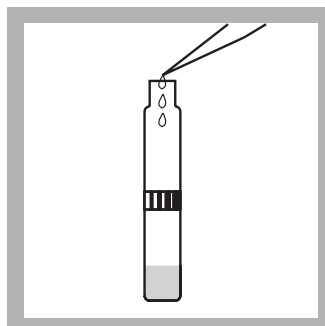

3. Pipet 2.0 mL of sample into the vial.

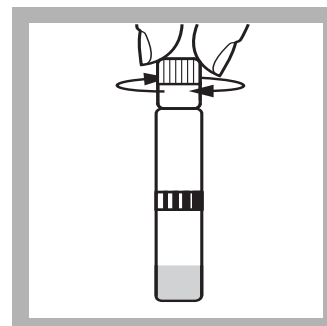

4. Flip the DosiCap Zip over so that the reagent side faces the vial. Screw the cap tightly onto the vial.

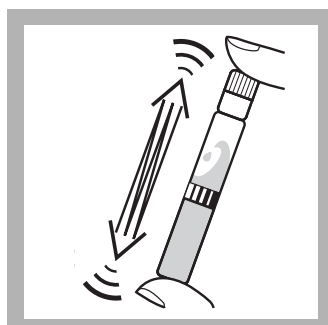

5. Shake the capped vial 2–3 times to dissolve the reagent in the cap.

Verify that the reagent has dissolved by looking down through the open end of the DosiCap Zip.

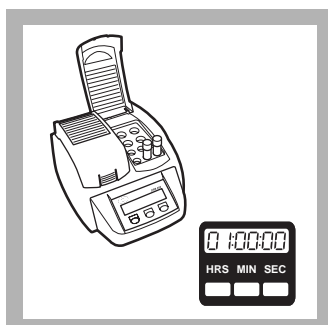

6. Heat the vials for one hour at 100 °C.

Install the Light Shield in Cell Compartment #2.

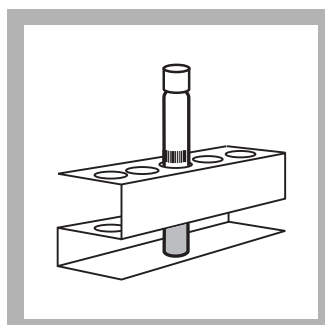

7. When the timer expires remove the hot vials from the reactor. Cool the vials to 15–35 °C. **Do not invert** the vial after digestion.

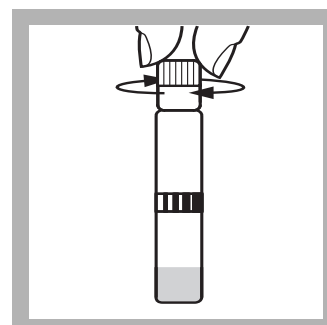

8. Screw an orange DosiCap B onto the cooled vial.

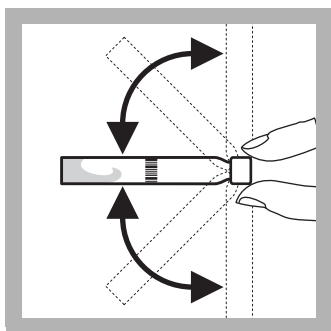

9. Invert the vial 2-3 times to mix.

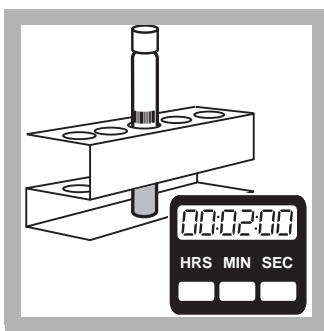

10. After inverting the tube, allow the vial to sit undisturbed for 2-3 minutes.

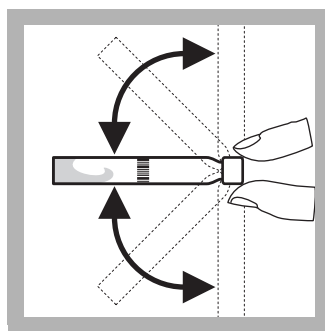

11. After the timer expires, invert the vial again 2-3 times.

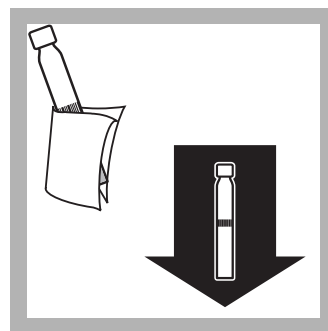

12. Thoroughly clean the outside of the vial.

Insert the prepared vial into the cell holder.

The instrument reads the barcode, then selects and performs the correct test. Results are in mg/L Cr.

No instrument Zero is required.

TNTplus Chromium, Hexavalent

Method 10218

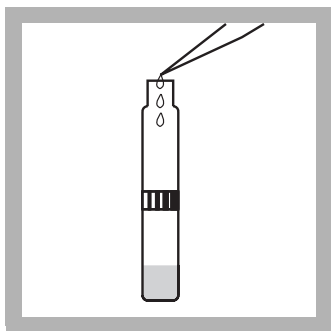

1. Pipet 2.0 mL of sample into the vial.

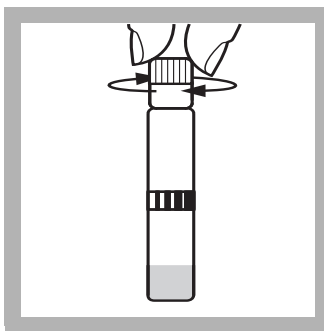

2. Screw an orange DosiCap B onto the cooled vial.

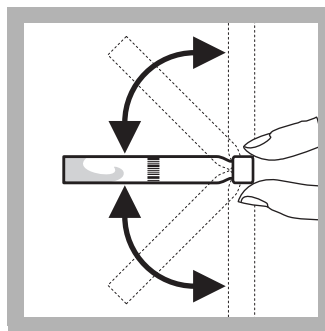

3. Invert the vial 2-3 times to mix.

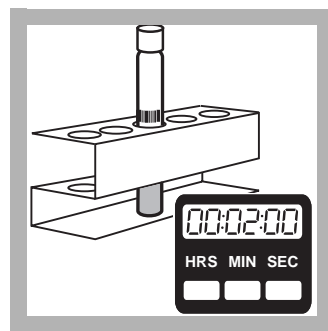

4. After inverting the tube, allow the vial to sit undisturbed for 2-3 minutes.

Install the Light Shield in Cell Compartment #2.

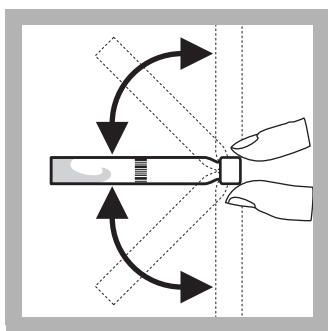

5. After the timer expires, invert the vial again 2–3 times.

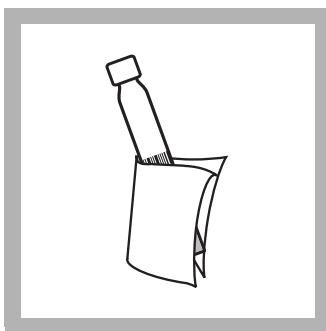

6. Thoroughly clean the outside of the vial.

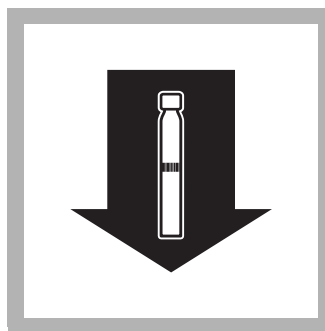

7. Insert the prepared vial into the cell holder.

The instrument reads the barcode, then selects and performs the correct test. Results are in mg/L Cr.

No instrument Zero is required.

Reagent Blanks

A reagent blank can be measured, and the value subtracted from the results of each test performed using the same reagent lot number. Use deionized water in place of sample and run the procedure as described.

To subtract the value of the blank from a series of measurements, measure the blank per step 12 of the total chromium procedure or step 7 of the hexavalent chromium procedure. Press **OPTIONS>MORE>REAGENT BLANK**. Press **ON**. The measured value of the blank should be displayed in the highlighted box. Press **OK** to accept this value. The reagent blank value will now be subtracted from all results until the function is turned off, or a different method is selected. Alternately, the blank can be recorded and entered at any later time by pressing the highlighted box and using the keypad to enter the value.

Sample Blanks

Colored or turbid samples can cause high results. The digestion in the total chromium procedure usually destroys all color and turbidity and a sample blank is not required. To compensate for color or turbidity in the determination of hexavalent chromium, the procedure is repeated and the color forming reagent that is present in the DosiCap B is not added.

To determine the sample blank for hexavalent chromium:

1. Run the procedure as written, but do not add the DosiCap B Reagent in step 2.
2. Cap the vial with the original DosiCap **Zip** (do not remove the foil).
3. The value obtained in step 7 is subtracted from the value obtained on the original hexavalent chromium sample to give the corrected sample concentration.

Alternatively, hexavalent chromium samples that contain turbidity only may be filtered through a membrane filter and analyzed using the hexavalent procedure. Results are reported as dissolved hexavalent chromium. Samples without color or turbidity do not require sample blanks.

Interferences

The ions listed in [Table 1](#) have been individually checked up to the given concentrations and do not cause interference. Cumulative effects and the influence of other ions have not been determined.

Larger amounts of iron, copper, and reducing and oxidizing agents give low-bias results. Lead, mercury and tin give high-bias results.

Important Note: Undissolved chromium is not determined with the determination of chromium(VI). An analyte concentration greatly (above 20 mg/L) in excess of the stated range will adversely affect color formation, resulting in a false reading within the method range.

Measurement results can be verified using sample dilutions or standard additions.

Table 1 Interfering Substances and Levels

Interfering Substance	Interference Level
SO ₄ ²⁻ , Na ⁺ , K ⁺ , NO ₃ ⁻	2000 mg/L
Cl ⁻	1000 mg/L
Ca ²⁺	125 mg/L
Mg ²⁺ , NH ₄ ⁺	100 mg/L
Zn ²⁺ , Ni ²⁺ , Co ²⁺ , Cd ²⁺	50 mg/L
Pb ²⁺	25 mg/L
Cu ²⁺ , Fe ³⁺	10 mg/L
Ag ⁺	5 mg/L
Sn ²⁺	1 mg/L

Sample Collection, Storage, and Preservation

Collect samples in acid-washed glass or plastic containers. To preserve samples for total chromium analysis, adjust the pH to 2 or less with nitric acid. This requires approximately 2 mL per liter of the acid. Store preserved samples at 4 °C (39.2 °F) for up to six months. Bring the sample temperature to 15–35 °C (59–95 °F) adjust the pH to about 4 with 5.0 N Sodium Hydroxide before analysis. To preserve samples for hexavalent chromium analysis, adjust the pH to 8 with 1N Sodium Hydroxide. Store at 4 °C (39.2 °F) for up to 24 hours. Bring sample to 15–35 °C (59–95 °F). No pH neutralization is required. Correct the test result for volume additions.

Accuracy Check

Standard Solution Method (Total Chromium)

To check the accuracy of the total chromium method, prepare a 0.50-mg/L trivalent chromium standard as follows:

1. Dilute 5.00 mL of Trivalent Chromium Standard Solution, 50-mg/L as Cr³⁺, to 500 mL with deionized water.
2. Use 2.0 mL of the trivalent chromium standard in place of the sample in step 3. Prepare this solution daily.

Standard Solution Method (Hexavalent Chromium)

To check the accuracy of the hexavalent chromium method, prepare a 0.50-mg/L hexavalent chromium standard as follows:

1. Dilute 5.00 mL of Hexavalent Chromium Standard Solution, 10 mg/L as Cr⁶⁺, to 100 mL with deionized water.
2. Use 2.0 mL of this 0.50 mg/L standard in place of the sample in step 2. Prepare this solution daily.

Summary of Method

In the total chromium procedure, all chromium in the sample is oxidized to the hexavalent chromium (Cr⁶⁺). The hexavalent chromium then reacts with 1,5-diphenylcarbazide to form 1,5-diphenylcarbazone. The amount of red color formed with hexavalent chromium is directly proportional to the amount of chromium present in the sample. Determine trivalent chromium by subtracting the results of a separate hexavalent chromium test from the results of the total chromium test. Test results are measured at 543 nm.

Consumables and Replacement Items

Required Reagents

Description	Quantity/Test	Unit	Cat. No.
Chromium, Total and Hexavalent TNTplus, TNT854 Reagent Set	1	25/pkg	TNT854

Required Apparatus

Description	Quantity/Test	Unit	Cat. No.
DRB200 Reactor, 115 V, 13x17 mm + 2x20 mm (mono block) OR	1	each	DRB200-01
DRB200 Reactor, 230 V, 9x13mm + 2x20 mm (mono block)	1	each	DRB200-05
Light Shield	1	each	LZV646
Pipet, variable volume, 1–5 mL	1	each	27951-00
Pipet Tips, for 27951-00 pipet	1	100/pkg	27952-00
Test Tube Cooling Rack	1–2	each	18641-00

Recommended Standards

Description	Unit	Cat. No.
Chromium, Trivalent, Standard Solution, 50-mg/L Cr ³⁺	100 mL	14151-42
Chromium, Hexavalent Standard Solution, 10, 2 mL ampules	20/pkg	25572-20

Optional Reagents and Apparatus

Description	Cat. No.
Bottle, Sampling, low density poly, w/cap, 500 mL, 12/pkg	20870-79
DRB200 Reactor, 115 V, 21x13mm + 4x20 mm (dual block)	DRB200-02
DRB200 Reactor, 115 V, 15x13 mm + 15x13 mm (dual block)	DRB200-03
DRB200 Reactor, 115 V, 12x13mm + 8x20 mm (dual block)	DRB200-04
DRB200 Reactor, 230 V, 21x13mm + 4x20 mm (dual block)	DRB200-06
DRB200 Reactor, 230V, 15x13 mm + 15 x 13 mm (dual block)	DRB200-07
DRB200 Reactor, 230 V, 12x13mm + 8x20 mm (dual block)	DRB200-08
Flask, filtering, glass, 1000-mL (SUVA)	546-53
Flask, volumetric, 100-mL	14574-42
Flask, volumetric, Class A, 500-mL	14574-49
Filter holder, glass for vacuum filtration (SUVA)	2340-00
Filter membrane, 47-mm, 0.45-micron hydrophilic polyethersulfone for SUVA	28947-00
Nitric Acid, ACS	152-49
pH paper, 0–14 units	26013-00
Pipette, volumetric, Class A, 5.00 mL	14515-37
Pipet, safety bulb	14561-00
Sodium Hydroxide, 1.0 N	1045-32
Sodium Hydroxide, 5.0 N	2450-32
TNTplus Reactor Adapter Sleeves, 16-00 to 13-mm diameter, 5/pkg	28958-05
Tubing, rubber, 12 ft	560-19



FOR TECHNICAL ASSISTANCE, PRICE INFORMATION AND ORDERING:

In the U.S.A. – Call toll-free 800-227-4224
Outside the U.S.A. – Contact the HACH office or distributor serving you.
On the Worldwide Web – www.hach.com; E-mail – techhelp@hach.com

HACH COMPANY
WORLD HEADQUARTERS
Telephone: (970) 669-3050
FAX: (970) 669-2932

Method 8078

1-(2-Pyridylazo)-2-Naphthol (PAN) Method¹

Powder Pillows

(0.01 to 2.00 mg/L)

Scope and Application: For water and wastewater; digestion is required for determining total recoverable cobalt; if EDTA is present, use the vigorous digestion.

¹ Adapted from Watanbe, H., *Talanta*, 21 295 (1974)



Test Preparation

Before starting the test:

For more accurate results, determine a reagent blank value for each new lot of reagent. Follow the procedure using deionized water instead of the sample. Subtract the reagent blank value from the final results or perform a reagent blank adjust.

If the sample is less than 10 °C (50 °F), warm to room temperature prior to analysis.

Nickel can be determined with the same sample prepared with this method. Use program Number 340. A reagent blank is necessary for the nickel procedure.

Collect the following items:

Quantity

Collect the following items:	Quantity
Cobalt Reagent Set, 10-mL, includes:	
EDTA Reagent Powder Pillows	2
Phthalate-Phosphate Reagent Powder Pillows	2
PAN Indicator Solution	1 mL
Water, deionized	25 mL
Cylinder, graduated mixing, 25-mL	2
Sample Cells, 1-inch square glass, 10-mL	2

Note: Reorder information for consumables and replacement items is on page 4.

Powder Pillows

Method 8078



1. Press **STORED PROGRAMS**.

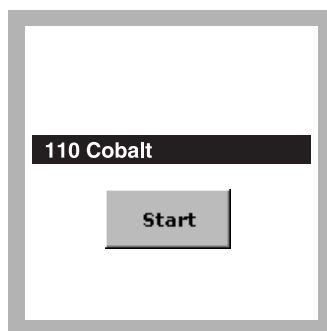

2. Select the test.

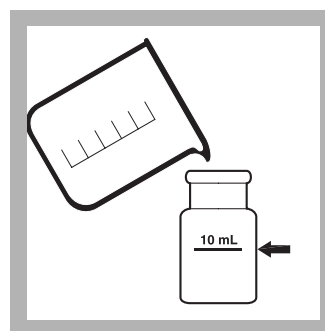

3. **Prepared Sample:** Fill a square sample cell to the 10-mL mark with sample.

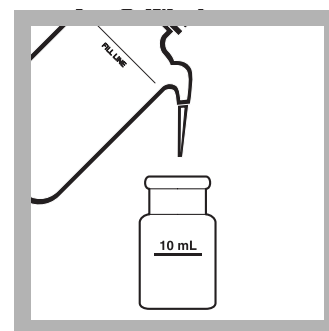

4. **Blank Preparation:** Fill a second square sample cell to the 10-mL mark with deionized water.

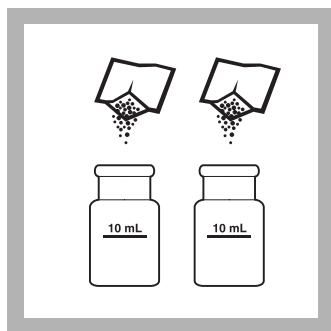

5. Add the contents of one Phthalate-Phosphate Reagent Powder Pillow to each cell.

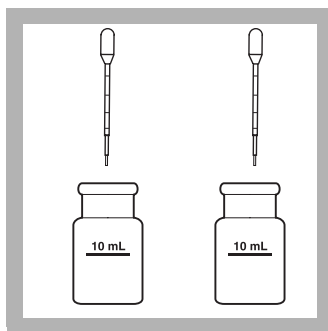

6. Use the plastic dropper provided to add 0.5 mL of 0.3% PAN Indicator Solution to each cell. Stopper each cell. Invert several times to mix.

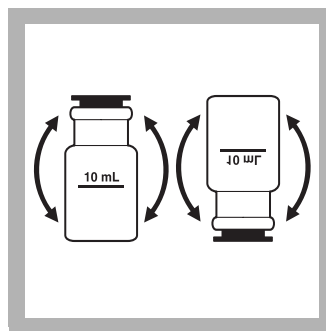

7. Stopper the cells. Invert several times to mix.

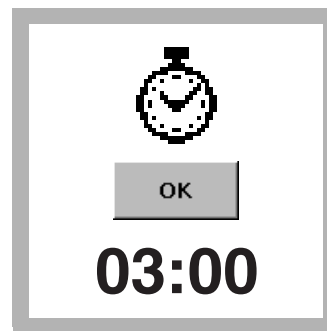

8. Press **TIMER>OK**.

A three-minute reaction period will begin.

During the reaction period, the sample solution may vary from green to dark red, depending on the chemical make-up of the sample. The deionized water blank should be yellow.

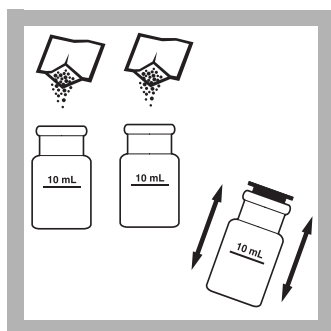

9. When the timer expires, add the contents of one EDTA Reagent Powder Pillow to each cylinder.

Stopper the cells.

Shake to dissolve.



10. Wipe the blank and insert it into the cell holder with the fill line facing right.

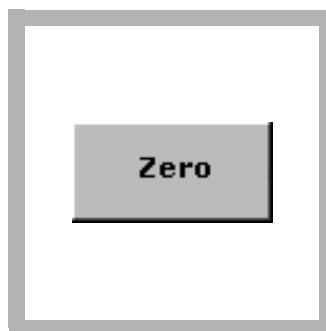

11. Press **ZERO**.

The display will show:

0.00 mg/L Co

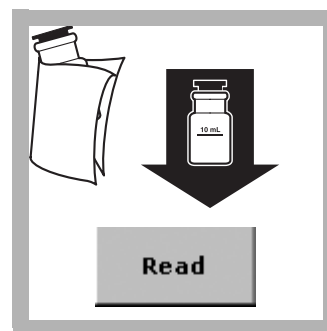

12. Wipe the prepared sample and insert it into the cell holder with the fill line facing right.

Press **READ**. Results are in mg/L Co.

Interferences

Table 1 Interfering Substances and Levels

Interfering Substance	Interference Levels and Treatments
Al ³⁺	32 mg/L
Ca ²⁺	1000 mg/L as CaCO ₃
Cd ²⁺	20 mg/L
Cl ⁻	8000 mg/L
Cr ³⁺	20 mg/L
Cr ⁶⁺	40 mg/L
Cu ²⁺	15 mg/L
F ⁻	20 mg/L
Fe ²⁺	Interferes directly and must not be present
Fe ³⁺	10 mg/L
K ⁺	500 mg/L
Mg ²⁺	400 mg/L
Mn ²⁺	25 mg/L
Mo ⁶⁺	60 mg/L
Na ⁺	5000 mg/L
Pb ²⁺	20 mg/L
Zn ²⁺	30 mg/L
Highly buffered samples or extreme sample pH	May exceed the buffering capacity of the reagents and require sample pretreatment.

Sample Collection, Storage, and Preservation

Collect samples in acid-washed plastic bottles. Adjust the sample pH to 2 or less with nitric acid* (about 5 mL per liter). Preserved samples can be stored up to six months at room temperature. Adjust the sample pH between 3 and 8 with 5.0 N Sodium Hydroxide Standard Solution* just before analysis. Do not exceed pH 8 as this may cause some loss of cobalt as a precipitate. Correct test results for volume additions.

Accuracy Check

Standard Solution Method

Prepare a 1.0 mg/L cobalt standard solution as follows:

1. Dilute 10.0 mL of a 10-mg/L working stock solution to 100 mL in a volumetric flask. Prepare the 10-mg/L working stock solution daily by diluting 10.00 mL of Cobalt Standard Solution, 1000-mg/L as Co, to 1000 mL with deionized water.
2. To adjust the calibration curve using the reading obtained with the 1.0-mg/L standard solution, press **OPTIONS>MORE** on the current program menu. Press **STANDARD ADJUST**.
3. Press **ON**. Press **ADJUST** to accept the displayed concentration. If an alternate concentration is used, press the number in the box to enter the actual concentration, then press **OK**. Press **ADJUST**.

* See [Optional Reagents and Apparatus on page 4](#).

Summary of Method

After buffering the sample and masking any Fe³⁺ with pyrophosphate, the cobalt is reacted with 1-(2-Pyridylazo)-2-Naphthol indicator. The indicator forms complexes with most metals present. After color development, EDTA is added to destroy all metal-PAN complexes except nickel and cobalt, which can both be determined using the same sample. Test results are measured at 620 nm.

Consumables and Replacement Items

Required Reagents

Description	Quantity/Test	Unit	Cat. No.
Cobalt Reagent Set, 10-mL (100 tests), includes:	—	—	26516-00
(2) EDTA Reagent Powder Pillows	2	100/pkg	7005-99
(2) Phthalate-Phosphate Reagent Powder Pillows	2	100/pkg	26151-99
(1) PAN Indicator Solution, 0.3%	1 mL	100 mL	21502-32
Water, deionized	25 mL	4 L	272-56

Required Apparatus

Description	Quantity/Test	Unit	Cat. No.
Cylinder, graduated mixing, 25-mL	2	each	20886-40
Sample Cells, 1-inch square, 10 mL, matched pair	2	2/pkg	24954-02
Stopper, rubber	2	6/pkg	1731-06

Recommended Standards

Description	Unit	Cat. No.
Cobalt Standard Solution, 1000-mg/L Co	100 mL	21503-42

Optional Reagents and Apparatus

Description	Cat. No.
Nitric Acid, 1:1	2540-49
Sodium Hydroxide Standard Solution, 5.0 N	2450-32



FOR TECHNICAL ASSISTANCE, PRICE INFORMATION AND ORDERING:
In the U.S.A. – Call toll-free 800-227-4224
Outside the U.S.A. – Contact the HACH office or distributor serving you.
On the Worldwide Web – www.hach.com; E-mail – techhelp@hach.com

HACH COMPANY
WORLD HEADQUARTERS
Telephone: (970) 669-3050
FAX: (970) 669-2932

Color, True and Apparent

Method 8025

Platinum-Cobalt Standard Method^{1, 2}

(15 to 500 units)

Scope and Application: For water, wastewater, and seawater; equivalent to NCASI method 253 for pulp and paper effluent using 465 nm (requires pH adjustment)

¹ Adapted from *Standard Methods for the Examination of Water and Wastewater* and *NCASI, Technical Bulletin No. 253*, Dec. 1971

² Adapted from *Wat. Res.* Vol. 30, No. 11, pp. 2771–2775, 1996



Test Preparation

Before starting the test:

NCASI procedure requires pH adjustment. Adjust the pH to 7.6 with 1.0 N HCl or 1.0 N NaOH. When adjusting the pH, if overall volume change is greater than 1%, start over and use a stronger acid or base. Use Program 125 when performing the NCASI procedure.

To test for **apparent color**, omit steps 3–6 and step 8. Use unfiltered deionized water in step 7 and unfiltered sample in step 9.

Collect the following items:

Quantity

Hydrochloric Acid Solution, 1.0 N (Program 125)	varies
Sodium Hydroxide, 1.00 N (Program 125)	varies
Water, deionized	50 mL
Filter Apparatus: membrane filter, filter holder, filter flask, and aspirator	1
Sample Cells, 1-inch square, 10 mL, matched pair	2
Stopper, rubber, one hole, No. 7	1
Tubing, rubber	1

Note: Reorder information for consumables and replacement items is on page 4.

Platinum-Cobalt

Method 8025



1. Press **STORED PROGRAMS**.



1. Select the test.
NCASI: Use Program 125 for the NCASI test.

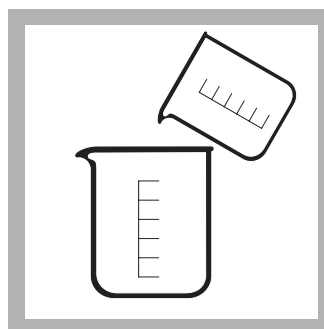

2. Collect 200 mL of sample in a 400-mL beaker.
NCASI: Adjust the pH as described in [Test Preparation](#).

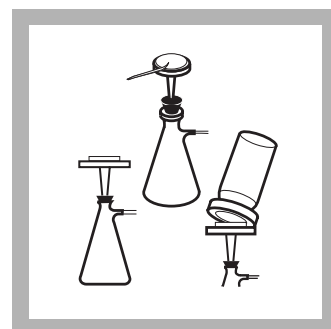

3. Assemble the filtering apparatus (0.45 micron membrane filter, filter holder, filter flask, and aspirator).

NCASI: Test prescribes a 0.8-micron filter.

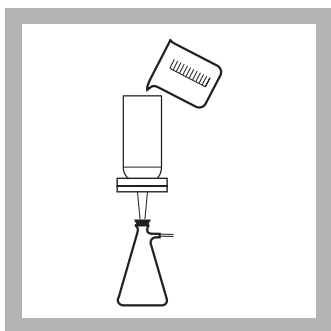

4. Rinse the filter by pouring about 50 mL of deionized water through the filter. Discard the rinse water.

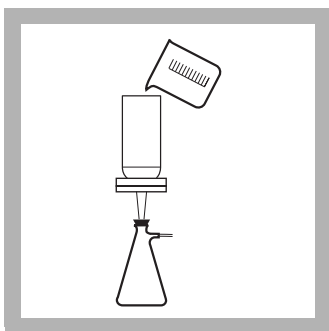

5. Pour another 50 mL of deionized water through the filter.

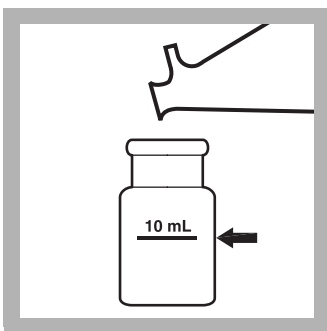

6. **Blank Preparation:** Fill a square sample cell with 10 mL of filtered deionized water from step 5.

Discard the excess water in the flask.

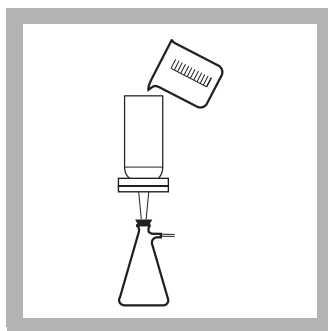

7. Pour about 50 mL of sample through the filter.

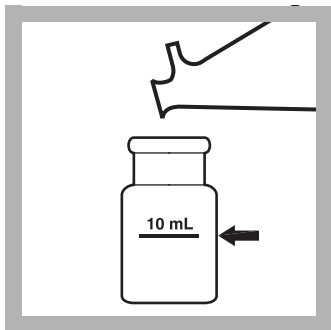

8. **Prepared Sample:** Fill a second square sample cell with 10 mL of filtered sample.



9. Wipe the blank and insert it into the cell holder with the fill line facing right.

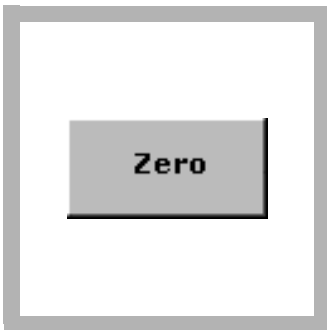

10. Press **ZERO**.
The display will show:
0 units PtCo



11. Wipe the prepared sample and insert it into the cell holder with the fill line facing right.
Press **READ**. Results are in mg/L PtCo.

Sample Collection, Storage, and Preservation

Collect samples in clean plastic or glass bottles. Most reliable results are obtained when samples are analyzed as soon as possible after collection. If prompt analysis is impossible, fill bottles completely and cap tightly. Avoid excessive agitation or prolonged contact with air. Samples can be stored for 24 hours by cooling to 4 °C (39 °F). Warm to room temperature before analysis.

Accuracy Check

Standard Solution Method

Prepare a 250 platinum-cobalt units standard as follows:

1. Using Class A glassware, pipet 50.00 mL of a 500 Platinum-Cobalt Units Standard Solution into a 100-mL volumetric flask. Dilute to the 100 mL mark with deionized water.
2. To adjust the calibration curve using the reading obtained with the 250 platinum-cobalt units standard, press **OPTIONS>MORE** on the current program menu. Press **STANDARD ADJUST**.
3. Press **ON**. Press **ADJUST** to accept the displayed concentration (the value depends on the selected units). If an alternate concentration is used, press the number in the box to enter the actual concentration, then press **OK**. Press **ADJUST**.

Summary of Method

Color may be expressed as “apparent” or “true” color. The apparent color includes that from dissolved materials plus that from suspended matter. By filtering or centrifuging out the suspended materials, the true color can be determined. The procedure describes true color analysis. If apparent color is desired, it can be determined by measuring an unfiltered water sample. The stored program is used for both forms of color.

The stored program is calibrated in color units based on the APHA-recommended standard of 1 color unit being equal to 1 mg/L platinum as chloroplatinate ion. Test results for Programs 120 and 125 are measured at 455 and 465 nm, respectively.

Consumables and Replacement Items**Required Reagents**

Description	Quantity/Test	Unit	Cat. No.
Hydrochloric Acid Solution, 1.0 N	varies	1 L	23213-53
Sodium Hydroxide, 1.00 N	varies	900 mL	1045-53
Water, deionized	50 mL	4 L	272-56

Required Apparatus

Description	Quantity/Test	Unit	Cat. No.
Aspirator, Nalgene vacuum pump	1	each	2131-00
Filter, membrane, 47-mm, 0.8-microns	1	100/pkg	26408-00
Filter, membrane, 47-mm, 0.45-microns	1	100/pkg	13530-00
Flask, filtering, 500-mL	1	each	546-49
Sample Cells, 1-inch square, 10 mL, matched pair	2	2/pkg	24954-02
Stopper, rubber, one hole, No. 7	1	6/pkg	2119-07
Tubing, rubber	1 ft	12 ft	560-19

Recommended Standards and Apparatus

Description	Unit	Cat. No.
Color Standard Solution, 500 platinum-cobalt units	1L	1414-53
Color Standard Solution, 15 platinum-cobalt units	1 L	26028-53
Color Standard Solution, 500 platinum-cobalt units, 10-mL Voluette® Ampules	16/pkg	1414-10
Flask, volumetric, Class A, 100 mL	each	14574-42
Pipet, volumetric, Class A, 50.00 mL	each	14515-41
Pipet Filler, safety bulb	each	14651-00



FOR TECHNICAL ASSISTANCE, PRICE INFORMATION AND ORDERING:
In the U.S.A. – Call toll-free 800-227-4224
Outside the U.S.A. – Contact the HACH office or distributor serving you.
On the Worldwide Web – www.hach.com; E-mail – techhelp@hach.com

HACH COMPANY
WORLD HEADQUARTERS
Telephone: (970) 669-3050
FAX: (970) 669-2932

Method 8143

Powder Pillows

Porphyrin Method¹

LR (1 to 210 µg/L)

Scope and Application: For water, wastewater, and sea water

¹ Adapted from Ishii and Koh, *Bunseki Kagaku*, 28 (473), 1979



Test Preparation

Before starting the test:

Digestion is required for determining total copper.

For more accurate results, determine a reagent blank value for each new lot of reagent. Follow the procedure using deionized water instead of the sample. Subtract the reagent blank value from the final results or perform a reagent blank adjust.

Wash all glassware with detergent. Rinse with tap water. Rinse again with 1:1 Nitric Acid Solution. Rinse a third time with copper-free, deionized water.

If samples contain high levels of metals, a slight metallic deposit or yellow buildup may form in the sample cell. Wash the cell as described above.

Collect the following items:

Quantity

Copper Masking Reagent Powder Pillows	1
Porphyrin 1 Reagent Powder Pillows	2
Porphyrin 2 Reagent Powder Pillows	2
Nitric Acid Solution, 1:1	varies
Sample Cells, 1-inch square	2

Note: Reorder information for consumables and replacement items is on page 5.

Powder Pillows

Method 8143



1. Press **STORED PROGRAMS**.

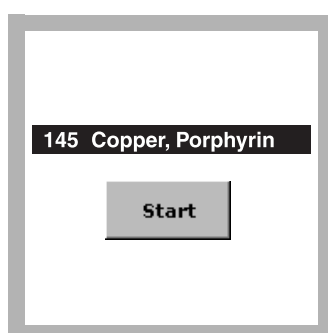

2. Select the test.

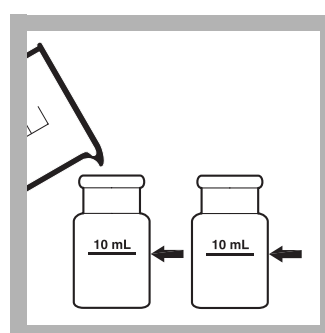

3. Fill two square sample cells with 10 mL of sample.

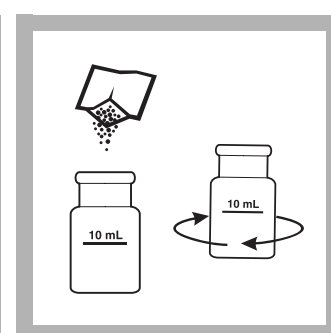

4. **Blank Preparation:** Add the contents of one Copper Masking Reagent Powder Pillow to one of the sample cells. Swirl to dissolve. This cell will be the blank.

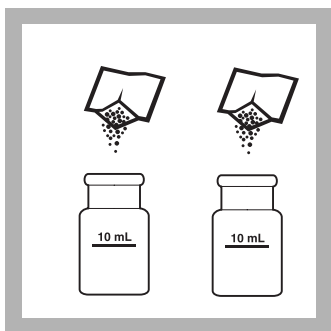

5. Add the contents of one Porphyrin 1 Reagent Powder Pillow to each sample cell.

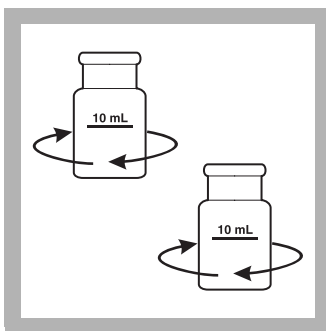

6. Swirl to dissolve.

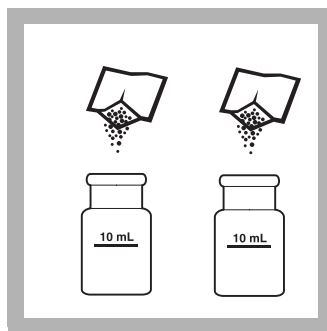

7. Add the contents of one Porphyrin 2 Reagent Powder Pillow to each sample cell.

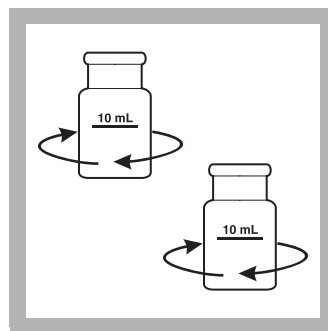

8. Swirl to dissolve.

If copper is present, the sample will momentarily turn blue, then return to yellow.

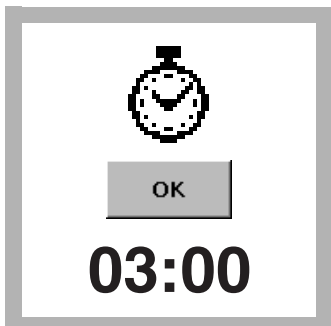

9. Press **TIMER>OK**.
A 3-minute reaction period will begin.



10. When the timer expires, insert the blank into the cell holder with the fill line facing right.

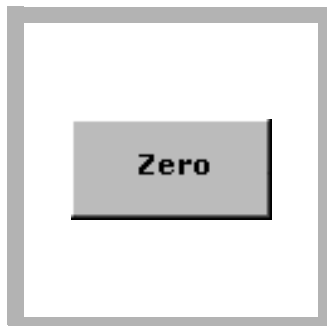

11. Press **ZERO**.
The display will show:
0 µg/L Cu



12. Insert the prepared sample into the cell holder with the fill line facing right.
Press **READ**. Results are in µg/L Cu.

Interferences

Table 1 Interfering Substances and Levels

Interfering Substance	Interference Levels and Treatments
Aluminum, Al ³⁺	60 mg/L
Cadmium, Cd ²⁺	10 mg/L
Calcium, Ca ²⁺	1500 mg/L
Chelating agents	Interfere at all levels unless either the Digesdahl or vigorous digestion is performed
Chloride, Cl ⁻	90,000 mg/L
Chromium, Cr ⁶⁺	110 mg/L
Cobalt, Co ²⁺	100 mg/L
Fluoride, F ⁻	30,000 mg/L
Iron, Fe ²⁺	6 mg/L
Lead, Pb ²⁺	3 mg/L
Magnesium	10,000 mg/L
Manganese	140 mg/L
Mercury, Hg ²⁺	3 mg/L
Molybdenum	11 mg/L
Nickel, Ni ²⁺	60 mg/L
Potassium, K ⁺	60,000 mg/L
Sodium, Na ⁺	90,000 mg/L
Zinc, Zn ²⁺	9 mg/L
Highly buffered samples or extreme sample pH	May exceed the buffering capacity of the reagents and require sample pretreatment.

Sample Collection, Storage, and Preservation

Collect samples in acid-washed plastic bottles. To preserve, adjust the pH to 2 or less with nitric acid (about 5 mL per liter). Store preserved samples up to six months at room temperature. Before testing, adjust the pH of the preserved sample to between 2 and 6. If the sample is too acidic, adjust the pH with 5.0 N Sodium Hydroxide Standard Solution*. Correct test results for volume additions.

Accuracy Check

Standard Additions Method (Sample Spike)

1. Prepare a 4000-µg/L copper standard by adding 4.00 mL Copper Standard Solution, 100-mg/L, to a 100-mL volumetric flask. Dilute to 100 mL with copper-free deionized water.
2. After reading test results, leave the sample cell (unspiked sample) in the instrument.
3. Press **OPTIONS>MORE**. Press **STANDARD ADDITIONS**. A summary of the standard additions procedure will appear.

* See [Optional Reagents and Apparatus](#) on page 5.

4. Press **OK** to accept the default values for standard concentration, sample volume, and spike volumes. Press **EDIT** to change these values. After values are accepted, the unspiked sample reading will appear in the top row. See the user manual for more information.
5. Fill eight sample cells with 10 mL of sample. Use the TenSette® Pipet to add 0.1 mL of Copper Standard Solution, 4000-µg/L Cu, to two of the sample cells. Then pipet 0.2 mL of the standard solution into two more cells. Finally, pipet 0.3 mL of the standard solution into two more cells.
6. Analyze each standard addition sample as described in the procedure above, using one of the two spiked samples in each set as the blank. Accept each standard additions reading by pressing **READ**. The copper concentration reading should reflect approximately 100% recovery.
7. After completing the sequence, press **GRAPH** to view the best-fit line through the standard additions data points, accounting for the matrix interferences. Press **IDEAL LINE** to view the relationship between the sample spikes and the "Ideal Line" of 100% recovery.

Standard Solutions Method

1. To assure the accuracy of the test, prepare a 150-µg/L copper standard by pipetting 15.00 mL of Copper Standard Solution, 10.0-mg/L Cu, into a 1000-mL volumetric flask.
2. Dilute to the mark with copper-free, reagent-grade water. Prepare this solution daily. Perform the copper procedure as described above.
3. To adjust the calibration curve using the reading obtained with the standard solution, press **OPTIONS>MORE** on the current program menu. Press **STANDARD ADJUST**.
4. Press **ON**. Press **ADJUST** to accept the displayed concentration. If an alternate concentration is used, press the number in the box to enter the actual concentration, then press **OK**. Press **ADJUST**.

Summary of Method

The porphyrin method is very sensitive to trace amounts of free copper. The method is free from most interferences and does not require any sample extraction or concentration before analysis. Interferences from other metals are eliminated by the copper masking reagent. The porphyrin indicator forms an intense, yellow-colored complex with any free copper present in sample. Test results are measured at 425 nm.

Consumables and Replacement Items

Required Reagents

Description	Quantity/Test	Unit	Cat. No.
Copper Reagent Set (100 tests), includes:	—	—	26033-00
(1) Copper Masking Reagent Powder Pillows	1	100/pkg	26034-49
(2) Porphyrin 1 Reagent Powder Pillows	2	100/pkg	26035-49
(2) Porphyrin 2 Reagent Powder Pillows	2	100/pkg	26036-49
Nitric Acid Solution, 1:1	varies	500 mL	2540-49

Required Apparatus

Description	Quantity/Test	Unit	Cat. No.
Sample Cells, 1-inch square, 10 mL, matched pair	2	2/pkg	24954-02

Recommended Standards

Description	Unit	Cat. No.
Copper Standard Solution, 100-mg/L Cu	100 mL	128-42
Copper Standard Solution, 10-mg/L Cu	100 mL	129-32
Water, deionized	4L	272-56

Optional Reagents and Apparatus

Description	Cat. No.
Sodium Hydroxide Standard Solution, 5.0 N	2450-32



FOR TECHNICAL ASSISTANCE, PRICE INFORMATION AND ORDERING:

In the U.S.A. – Call toll-free 800-227-4224
Outside the U.S.A. – Contact the HACH office or distributor serving you.
On the Worldwide Web – www.hach.com; E-mail – techhelp@hach.com

HACH COMPANY
WORLD HEADQUARTERS
Telephone: (970) 669-3050
FAX: (970) 669-2932

☆ Method 8506 and Method 8026

Powder Pillows or AccuVac[®] Ampuls

(0.04 to 5.00 mg/L)

Scope and Application: For water, wastewater and seawater²; Method 8506 USEPA approved for reporting wastewater analysis (digestion required)³

¹ Adapted from Nakano, S., *Yakugaku Zasshi*, 82 486-491 (1962) [*Chemical Abstracts*, 58 3390e (1963)]

² Pretreatment required; see *Interferences (Using Powder Pillows)*

³ *Federal Register*, 45 (105) 36166 (May 29, 1980)



Test Preparation

Before starting the test:

Digestion is required for determining total copper.

Adjust the pH of acid-preserved samples to 4–6 with 8 N KOH before analysis.

For more accurate results, determine a reagent blank value for each new lot of reagent. Follow the procedure using deionized water instead of the sample. Subtract the reagent blank value from the final results or perform a reagent blank adjust.

Collect the following items:

Quantity

Powder Pillow Test:	
CuVer [®] 1 Copper Reagent powder pillow	1
Sample Cells, 1-in. square, 10-mL (Powder Pillow Test)	2
AccuVac Test:	
CuVer [®] 2 Copper Reagent AccuVac [®] Ampul	1
Beaker, 50-mL (AccuVac test)	1
Sample Cell, 10-mL (AccuVac test)	1

Note: Reorder information for consumables and replacement items is on page 6.

Note: If copper is present, the sample will turn purple when it mixes with the reagent powder.

Note: Accuracy is not affected by undissolved powder.



1. Press **STORED PROGRAMS**.



2. Select the test.

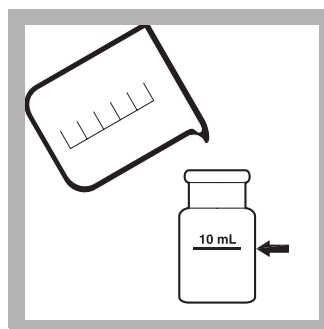

3. **Prepared Sample:** Fill a square sample cell with 10 mL of sample.

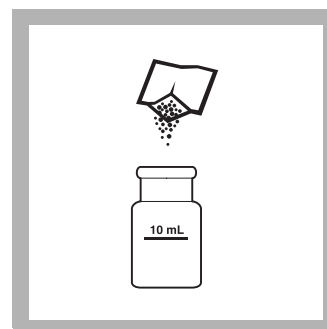

4. Add the contents of one CuVer® 1 Copper Reagent Powder Pillow to the sample cell (the prepared sample). Twirl sample cell to mix.

Use a CuVer 2 Copper Reagent Pillow for samples containing high levels of aluminum, iron, and hardness. A 25-mL sample cell is required. See [Table 1](#).

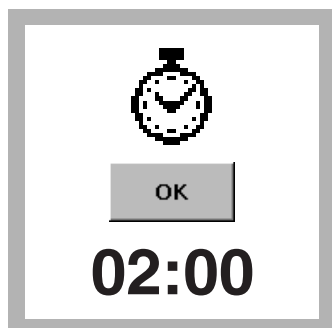

5. Press **TIMER>OK**.
A 2-minute reaction period will begin.

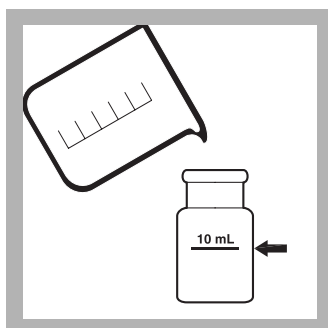

6. **Blank Preparation:** When the timer expires, fill a second square sample cell with 10 mL of sample.

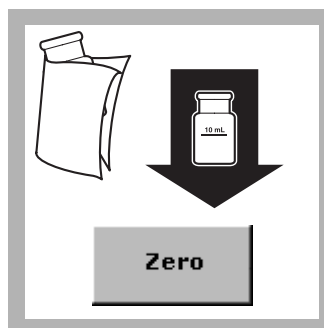

7. Insert the blank into the cell holder with the fill line facing right.
Press **ZERO**.
The display will show:
0.00 mg/L Cu

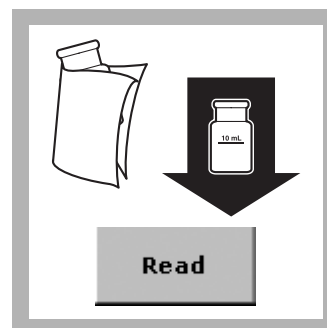

8. Within 30 minutes after the timer expires, insert the prepared sample into the cell holder with the fill line facing right.
Press **READ**. Results are in mg/L Cu.

AccuVac® Ampul

Method 8026

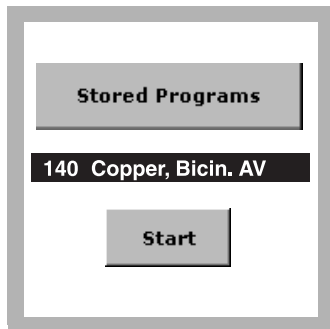

1. Select the test.

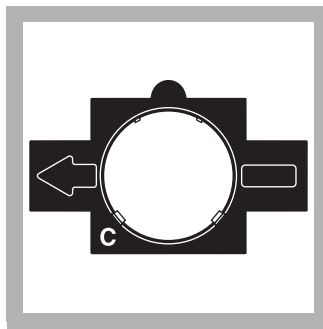

2. Insert Adapter C.

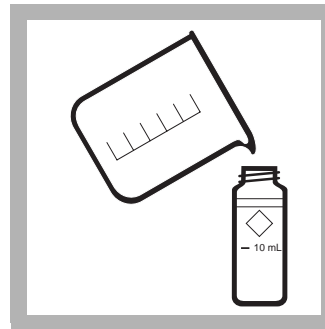

3. **Blank Preparation:**
Fill a round sample cell with 10-mL of sample.



4. **Prepared Sample:**
Collect at least 40 mL of sample in a 50-mL beaker.

Fill a CuVer 2 AccuVac Ampul with sample. Keep the tip immersed while the Ampul fills completely.

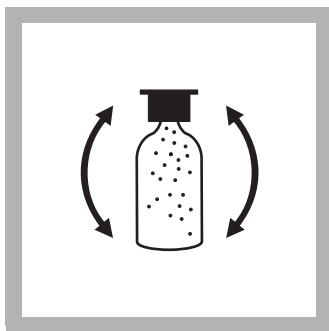

5. Quickly invert the Ampul several times to mix. Wipe off any liquid or fingerprints with cloth or soft paper towel.



6. Press **TIMER>OK**
A 2-minute reaction period will begin.

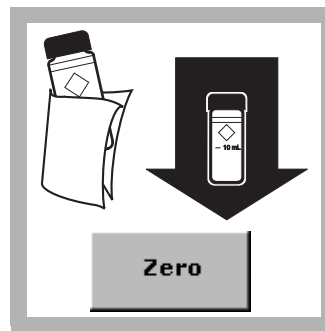

7. When the timer expires, insert the blank into the cell holder. Close the cover.

Press **ZERO**.
The display will show:

0.00 mg/L Cu



8. Within 30 minutes after the timer expires, insert the AccuVac Ampul into the cell holder.

Press **READ**. Results are in mg/L Cu.

Interferences

Table 1 suggests treatments for powder pillows. Table 2 suggests treatments for AccuVac Ampuls. To differentiate free copper from that complexed to EDTA or other complexing agents, use a 25-mL sample cell and Free Copper Reagent Powder Pillow instead of the CuVer 1 Powder Pillow in step 4. Results in step 8 will be free copper only. Add a Hydrosulfite Reagent Powder Pillow to the same sample and re-read the result. This result will include the total dissolved copper (free and complexed). Unlike CuVer 1 Reagent, CuVer 2 Reagent Powder Pillows and AccuVac Ampuls react directly with copper, which is complexed by chelants such as EDTA.

Table 1 Interfering Substances and Suggested Treatments for Powder Pillows

Interfering Substance	Interference Levels and Treatments
Acidity	If the sample is extremely acidic (pH 2 or less) a precipitate may form. Add 8 N Potassium Hydroxide Standard Solution drop-wise until sample pH is above 4. Continue with step 3.
Aluminum, Al ³⁺	Follow the powder pillow procedure above, but substitute a CuVer 2 Copper Reagent Powder Pillow for the CuVer 1 Pillow used in step 4. Results obtained will include total dissolved copper (free and complexed). Requires a 25-mL sample volume.
Cyanide, CN ⁻	Prevents full color development. Before adding the CuVer 1 Powder Pillow Reagent, add 0.2 mL of formaldehyde to the 10-mL sample. Wait 4 minutes before taking the reading. Multiply the test results by 1.02 to correct for sample dilution by the formaldehyde.
Hardness	Follow the powder pillow procedure above, but substitute a CuVer 2 Copper Reagent Powder Pillow for the CuVer 1 Pillow used in step 4. Results obtained will include total dissolved copper (free and complexed). Requires a 25-mL sample volume.
Iron, Fe ³⁺	Follow the powder pillow procedure above, but substitute a CuVer 2 Copper Reagent Powder Pillow for the CuVer 1 Pillow used in step 4. Results obtained will include total dissolved copper (free and complexed). Requires a 25-mL sample volume.
Silver, Ag ⁺	If a turbidity remains and turns black, silver interference is likely. Add 10 drops of saturated Potassium Chloride Solution to 75 mL of sample, followed by filtering through a fine or highly retentive filter. Use the filtered sample in the procedure.

Table 2 Interfering Substances and Suggested Treatments for AccuVac® Ampuls

Interfering Substance	Interference Levels and Treatments
Acidity	If the sample is extremely acidic (pH 2 or less) a precipitate may form. Add 8 N Potassium Hydroxide Standard Solution drop-wise until sample pH is above 4. Continue with step 3.
Aluminum, Al ³⁺	Reagents accommodate high levels.
Cyanide, CN ⁻	Prevents full color development. Add 0.5 mL of formaldehyde per 25-mL of sample before using CuVer 2 Reagent AccuVac Ampul. Wait 4 minutes before taking the reading. Multiply the test results by 1.02 to correct for sample dilution by the formaldehyde.
Hardness	Reagents accommodate high levels.
Iron, Fe ³⁺	Reagents accommodate high levels.
Silver, Ag ⁺	If a turbidity remains and turns black, silver interference is likely. Add 10 drops of saturated Potassium Chloride Solution to 75 mL of sample, followed by filtering through a fine or highly retentive filter. Use the filtered sample in the procedure.

Sample Collection, Storage, and Preservation

Collect samples in acid-cleaned glass or plastic containers. Adjust the pH to 2 or less with concentrated nitric acid (about 2 mL per liter). Store preserved samples up to six months at room temperature. Before analysis, adjust the pH to 4–6 with 8 N Potassium Hydroxide. Do not exceed pH 6, as copper may precipitate. Correct the test result for volume additions. If only dissolved copper is to be determined, filter the sample before acid addition.

Accuracy Check

Standard Additions Method (Sample Spike)

1. After reading test results, leave the sample cell (unspiked sample) in the instrument.
2. Press **OPTIONS>MORE**. Press **STANDARD ADDITIONS**. A summary of the standard additions procedure will appear.
3. Press **OK** to accept the default values for standard concentration, sample volume, and spike volumes. Press **EDIT** to change these values. After values are accepted, the unspiked sample reading will appear in the top row. See the user manual for more information.
4. Snap the neck off a Copper Voluette® Ampule Standard, 12.5-mg/L Cu.
5. Prepare a 0.1 mL sample spike by adding 0.1 mL of standard to the unspiked sample. Press the timer icon. After the timer expires, read the result.
6. Prepare a 0.2 mL sample spike by adding 0.1 mL of standard to the 0.1 mL sample spike. Press the timer icon. After the timer expires, read the result.
7. Prepare a 0.3 mL sample spike by adding 0.1 mL of standard to the 0.2 mL sample spike. Press the timer icon. After the timer expires, read the result. Each addition should reflect approximately 100% recovery.

Note: For AccuVac Ampuls, fill three mixing cylinders with 50-mL of sample and spike with 0.2 mL, 0.4 mL, and 0.6 mL of Copper Voluette Ampule Standard, 75-mg/L Cu. Transfer 40 mL from each of the three mixing cylinders to three 50-mL beakers. Analyze each standard addition sample as described in the procedure above. Accept each standard additions reading by pressing **READ**. Each addition should reflect approximately 100% recovery.

8. After completing the sequence, press **GRAPH** to view the best-fit line through the standard additions data points, accounting for matrix interferences. Press **IDEAL LINE** to view relationships between the sample spikes and the "Ideal Line" of 100% recovery.

Standard Solutions Method

Prepare a 4.00-mg/L Standard as follows:

1. Using Class A glassware, pipet 4.00 mL of Copper Standard Solution, 100-mg/L as Cu, into a 100-mL volumetric flask. Dilute to volume with deionized water, stopper and invert to mix. Perform the procedure as described above.
2. To adjust the calibration curve using the reading obtained with the standard solution, press **OPTIONS>MORE** on the current program menu. Press **STANDARD ADJUST**.
3. Press **ON**. Press **ADJUST** to accept the displayed concentration. If an alternate concentration is used, press the number in the box to enter the actual concentration, then press **OK**. Press **ADJUST**.

Summary of Method

Copper in the sample reacts with a salt of bichinchonic acid contained in CuVer 1 or CuVer 2 Copper Reagent to form a purple colored complex in proportion to the copper concentration. Test results are measured at 560 nm.

Copper (0.04 to 5.00 mg/L)

Consumables and Replacement Items

Required Reagents

Description	Quantity/Test	Unit	Cat. No.
CuVer® 1 Copper Reagent Powder Pillows	1	100/pkg	21058-69
OR			
CuVer® 2 Copper Reagent AccuVac® Ampuls	1	25/pkg	25040-25

Required Apparatus (Powder Pillows)

Description	Quantity/Test	Unit	Cat. No.
Sample Cells, 1-inch square, 10 mL, matched pair	2	2/pkg	24954-02

Required Apparatus (AccuVac)

Description	Quantity/Test	Unit	Cat. No.
Adapter, 1-inch round, for AccuVac Ampuls	1	each	LZV584
Beaker, 50-mL	1	each	500-41H
Sample Cell, 10-mL, with cap	1	each	21228-00

Recommended Standards

Description	Unit	Cat. No.
Copper Standard Solution, 100-mg/L as Cu	100 mL	128-42
Copper Voluette® Ampule Standard, 12.5-mg/L as Cu	16/pkg	21126-10
Copper Voluette® Ampule Standard, 75-mg/L as Cu, 2-mL	10/pkg	14247-10
Metals Drinking Water Standard, LR for Cu, Fe, Mn	500 mL	28337-49
Metals Drinking Water Standard, HR for Cu, Fe, Mn	500 mL/L	28336-49

Optional Reagents and Apparatus

Description	Cat. No.
Beakers, 50-mL	500-41H
CuVer 2 Copper Reagent Powder Pillow	21882-99
Cylinders, mixing	1896-41
Formaldehyde	2059-32
Nitric Acid, concentrated	152-49
Potassium Chloride Solution	765-42
Potassium Hydroxide Standard Solution, 8 N	282-32H
Reagent Set for Free and Total Copper, includes:	24392-00
Hydrosulfite Reagent Powder Pillows	21188-69
Free Copper Reagent Powder Pillows	21823-69
Sample Cells, 25 mL, with stoppers, 2/pkg	26126-02



FOR TECHNICAL ASSISTANCE, PRICE INFORMATION AND ORDERING:
In the U.S.A. – Call toll-free 800-227-4224
Outside the U.S.A. – Contact the HACH office or distributor serving you.
On the Worldwide Web – www.hach.com; E-mail – techhelp@hach.com

HACH COMPANY
WORLD HEADQUARTERS
Telephone: (970) 669-3050
FAX: (970) 669-2932

Method 8027

Pyridine-Pyrazalone Method¹

Powder Pillows

(0.002 to 0.240 mg/L CN⁻)

Scope and Application: For water, wastewater, and seawater

¹ Adapted from Epstein, Joseph, *Anal. Chem.* 19(4), 272 (1947)



Test Preparation

Before starting the test:

Use a water bath to maintain the optimum temperature for the reaction in this test (25 °C). Samples at less than 23 °C require longer reaction times, and samples at greater than 25 °C yield low results.

For more accurate results, determine a reagent blank value for each new lot of reagent. Follow the procedure using deionized water instead of the sample. Subtract the reagent blank value from the final results or perform a reagent blank adjust.

The timing for steps 3–10 is critical. You may find it useful to open the necessary reagents before starting this sequence.

All samples to be analyzed for cyanide should be treated by acid distillation except when experience has shown that there is no difference in results obtained with or without distillation. See [Acid Distillation on page 5](#).

See [Pollution Prevention and Waste Management on page 3](#) for proper disposal of solutions containing cyanide.

Collect the following items

Quantity

CyaniVer® Cyanide 3 Reagent Powder Pillow	1
CyaniVer® Cyanide 4 Reagent Powder Pillow	1
CyaniVer® Cyanide 5 Reagent Powder Pillow	1
Cylinder, graduated, 10-mL	1
Sample Cells, 1-inch square glass	2

Note: Reorder information for consumables and replacement items is on [page 7](#).

Powder Pillows

Method 8027

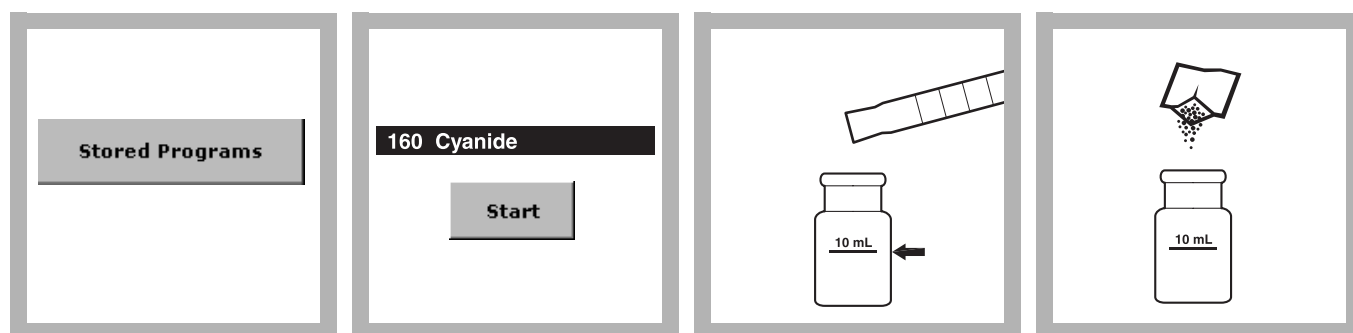

1. Press **STORED PROGRAMS**.

2. Select the test.

3. Using a graduated cylinder, fill a square sample cell with a 10 mL of sample.

4. **Prepared Sample:** Add the contents of one CyaniVer 3 Cyanide Reagent Powder Pillow. Cap the cell.

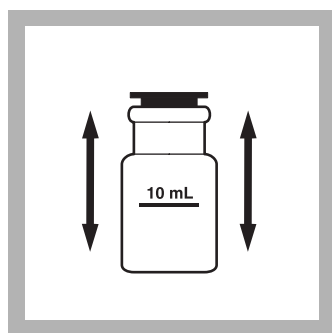

5. Shake the sample cell for 30 seconds.

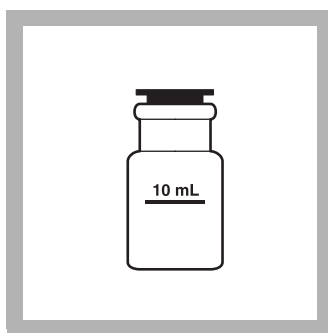

6. Leave the sample cell undisturbed for an additional 30 seconds.

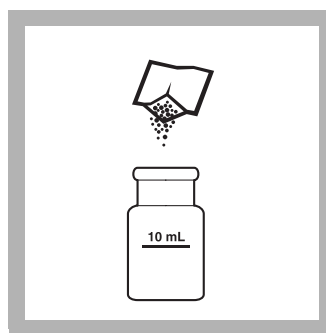

7. Add the contents of one CyaniVer 4 Cyanide Reagent Powder Pillow. Cap the sample cell.

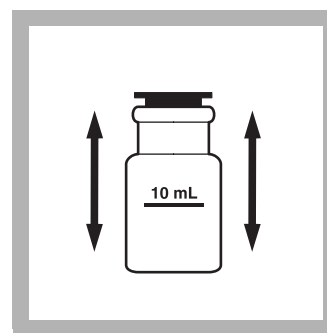

8. Shake the sample for 10 seconds. Immediately proceed to *step 9*. (Delaying the addition of the CyaniVer 5 will produce low test results.)

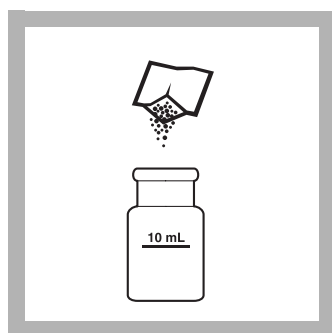

9. Add the contents of one CyaniVer 5 Cyanide Reagent Powder Pillow. Cap the sample cell.

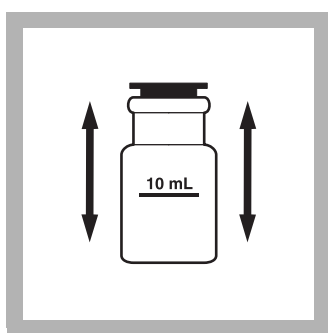

10. Shake the cell vigorously. If cyanide is present, a pink color will develop.



11. Press **TIMER>OK**. A 30-minute reaction period will begin. The solution will turn from pink to blue.

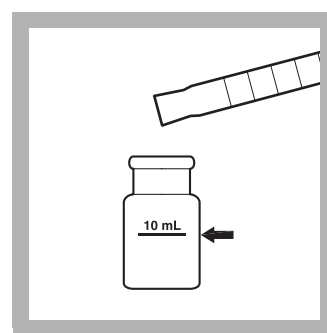

12. **Blank Preparation:** When the timer expires, fill a second square sample cell with 10 mL of sample.



13. Wipe the blank and insert it into the cell holder with the fill line facing right.

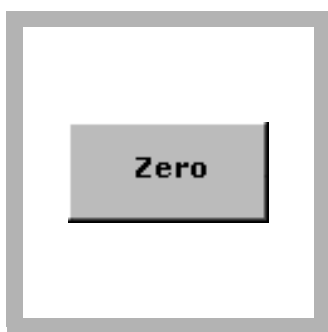

14. Press **ZERO**. The display will show: 0.000 mg/L CN⁻



15. Wipe the prepared sample and insert it into the cell holder with the fill line facing right.

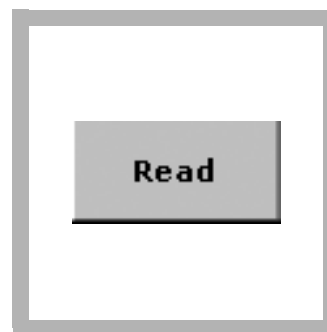

16. Press **READ**. Results are in mg/L CN⁻.

Pollution Prevention and Waste Management

Special Considerations for Cyanide Containing Materials

Samples analyzed by this procedure may contain cyanide, which is regulated as reactive (D003) waste by the federal RCRA. It is imperative these materials be handled safely to prevent the release of hydrogen cyanide gas (an extremely toxic material with the smell of almonds). Most cyanide compounds are stable and can be safely stored for disposal in highly alkaline solutions (pH >11) such as 2 N sodium hydroxide. Never mix these wastes with other laboratory wastes which may contain lower pH materials such as acids or even water.

In the event of a spill or release, special precautions must be taken to prevent exposure to hydrogen cyanide gas. The following steps may be taken to destroy the cyanide compounds in the event of an emergency:

- Use a fume hood or supplied air or self contained breathing apparatus.
- While stirring, add the waste to a beaker containing a strong solution of sodium hydroxide and calcium hypochlorite or sodium hypochlorite (household bleach).
- Maintain a strong excess of hydroxide and hypochlorite. Let the solution stand for 24 hours.
- Neutralize and flush the solution down the drain with a large excess of water.

Note: If the solution contains other regulated materials such as chloroform or heavy metals, it may still need to be collected for hazardous waste disposal. Never flush hazardous wastes down the drain.

Interferences

Table 1 Interfering Substances and Levels

Interfering Substance	Interference Levels and Treatments
Chlorine	Large amounts of chlorine in the sample will cause a milky white precipitate after the addition of the CyaniVer® 5 Reagent. If chlorine or other oxidizing agents are known to be present, pretreat the sample before testing using the procedure in this table for oxidizing agents.
Metals	Nickel or cobalt in concentrations up to 1 mg/L do not interfere. Eliminate the interference from up to 20 mg/L copper and 5 mg/L iron by adding the contents of one HexaVer Chelating Reagent Powder Pillow ¹ to the sample and then mixing before adding the CyaniVer 3 Cyanide Reagent Powder Pillow in step 4. Prepare a reagent blank of deionized water and reagents to zero the instrument in step 14.
Oxidizing Agents	<ol style="list-style-type: none"> 1. Adjust a 25-mL portion of the alkaline sample to pH 7–9 with 2.5 N Hydrochloric Acid Standard Solution¹. Count the number of drops of acid added. 2. Add two drops of Potassium Iodide Solution¹ and two drops of Starch Indicator Solution¹ to the sample. Swirl to mix. The sample will turn blue if oxidizing agents are present. 3. Add Sodium Arsenite Solution¹ drop-wise until the sample turns colorless. Swirl the sample thoroughly after each drop. Count the number of drops. 4. Take another 25-mL sample and add the total number of drops of Hydrochloric Acid Standard Solution counted in step a. 5. Subtract one drop from the amount of Sodium Arsenite Solution added in step c. Add this amount to the sample and mix thoroughly. Continue with step 3 of the cyanide procedure.

Table 1 Interfering Substances and Levels (continued)

Interfering Substance	Interference Levels and Treatments
Reducing Agents	<ol style="list-style-type: none"> 1. Adjust a 25-mL portion of the alkaline sample to pH 7–9 with 2.5 N Hydrochloric Acid Standard Solution¹. Count the number of drops added. 2. Add four drops of Potassium Iodide Solution¹ (Cat. No. 343-32) and four drops of Starch Indicator Solution to the sample. Swirl to mix. The sample should be colorless. 3. Add Bromine Water¹ drop-wise until a blue color appears. Swirl the sample thoroughly after each addition. Count the number of drops. 4. Take another 25-mL sample and add the total number of drops of Hydrochloric Acid Standard Solution counted in step a. 5. Add the total number of drops of Bromine Water counted in <i>step c</i> to the sample and mix thoroughly. 6. Continue with step 3 of the cyanide procedure.
Turbidity	Large amounts of turbidity will cause high readings. Use filter paper ¹ and a funnel ¹ to filter highly turbid water samples before use in steps 3 and 12. The test results should then be recorded as soluble cyanide.

¹ See [Optional Reagents and Apparatus on page 8](#).

Sample Collection, Storage, and Preservation

Collect samples in glass or plastic bottles and analyze as quickly as possible.

The presence of oxidizing agents, sulfides and fatty acids can cause the loss of cyanide during sample storage. Samples containing these substances must be pretreated as described below before preservation with sodium hydroxide. If the sample contains sulfide and is not pretreated, it must be analyzed within 24 hours.

Preserve the sample by adding 4.0 mL of 5.0 N Sodium Hydroxide Standard Solution* to each liter (or quart) of sample, using a glass serological pipet and pipet filler. Check the sample pH; 4-mL of sodium hydroxide is usually enough to raise the pH of most water and wastewater samples to 12. Add more 5.0 N Sodium Hydroxide if necessary. Store the samples at 4 °C (39 °F) or less. Samples preserved in this manner can be stored for 14 days.

Before testing, samples preserved with 5.0 N Sodium Hydroxide or samples that are highly alkaline due to chlorination treatment processes or sample distillation procedures should be adjusted to approximately pH 7 with 2.5 N Hydrochloric Acid Standard Solution. Where significant amounts of preservative are used, a volume correction should be made.

Oxidizing Agents

Oxidizing agents such as chlorine decompose cyanides during storage. To test for their presence and to eliminate their effect, pretreat the sample as follows:

1. Take a 25-mL portion of the sample and add one drop of 10-g/L m-Nitrophenol Indicator Solution*. Swirl to mix.
2. Add 2.5 N Hydrochloric Acid Standard Solution drop-wise until the color changes from yellow to colorless. Swirl the sample thoroughly after the addition of each drop.
3. Add two drops of Potassium Iodide Solution*, 30-g/L, and two drops of Starch Indicator Solution, to the sample. Swirl to mix. The solution will turn blue if oxidizing agents are present.

* See [Optional Reagents and Apparatus on page 8](#).

4. If step 3 suggests the presence of oxidizing agents, add two level, 1-g measuring spoonfuls of Ascorbic Acid* per liter of sample.
5. Withdraw a 25-mL portion of sample treated with ascorbic acid and repeat *steps 1 to 3*. If the sample turns blue, repeat *steps 4 and 5*.
6. If the 25-mL sample remains colorless, preserve the remaining sample to pH 12 for storage with 5 N Sodium Hydroxide Standard Solution* (usually 4-mg/L).
7. Perform the procedure given under [Interfering Substances and Levels](#), Reducing Agents, to eliminate the effect of excess ascorbic acid, before following the cyanide procedure.

Sulfides

Sulfides will quickly convert cyanide to thiocyanate (SCN⁻). To test for the presence of sulfide and eliminate its effect, pretreat the sample as follows:

1. Place a drop of sample on a disc of Hydrogen Sulfide Test Paper* that has been wetted with pH 4 Buffer Solution*.
2. If the test paper darkens, add a 1-g measuring spoon of Lead Acetate to the sample. Repeat *step a*.
3. If the test paper continues to turn dark, keep adding Lead Acetate* until the sample tests negative for sulfide.
4. Filter the lead sulfide precipitate through Filter Paper* and a Funnel*. Preserve the sample for storage with 5 N Sodium Hydroxide Standard Solution* or neutralize to a pH of 7 for analysis.

Fatty Acids

Caution

Perform this operation under a ventilation hood and as quickly as possible.

When distilled, fatty acids will pass over with cyanide and, under the alkaline conditions of the absorber, will form soaps. If the presence of fatty acid is suspected, use the following pretreatment before preserving samples with sodium hydroxide.

1. Acidify 500 mL of sample to pH 6 or 7 with a 4:1 dilution of glacial Acetic Acid*.
2. Pour the sample into a 1000-mL separation funnel and add 50 mL of Hexane*.
3. Stopper the funnel and shake for one minute. Allow the layers to separate.
4. Drain off the lower, sample layer into a 600-mL beaker. If the sample is to be stored, add enough 5 N Sodium Hydroxide Standard Solution* to raise the pH above 12.

Acid Distillation

All samples to be analyzed for cyanide should be treated by acid distillation except when experience has shown that there is no difference in results obtained with or without distillation. With most compounds, a one-hour reflux is adequate.

If thiocyanate is present in the original sample, a distillation step is absolutely necessary as thiocyanate causes a positive interference. High concentrations of thiocyanate can yield a substantial quantity of sulfide in the distillate. The "rotten egg" smell of hydrogen sulfide will accompany the distillate when sulfide is present. The sulfide must be removed from the distillate prior to testing.

* See [Optional Reagents and Apparatus](#) on page 8.

If cyanide is not present, the amount of thiocyanate can be determined. The sample is not distilled and the final reading is multiplied by 2.2. The result is mg/L SCN⁻.

The distillate can be tested and treated for sulfide after the last step of the distillation procedure by using the following lead acetate treatment procedure.

1. Place a drop of the distillate (already diluted to 250 mL) on a disc of Hydrogen Sulfide Test Paper* that has been wetted with pH 4.0 Buffer Solution*.
2. If the test paper darkens, add 2.5 N Hydrochloric Acid Standard Solution* drop-wise to the distillate until a neutral pH is obtained.
3. Add a 1-g measuring spoon of lead acetate* to the distillate and mix. Repeat step 1.
4. If the test paper continues to turn dark, keep adding lead acetate until the distillate tests negative for sulfide.
5. Filter the black lead sulfide precipitate through filter paper* and a funnel*. Neutralize the liquid filtrate to pH 7 and immediately analyze for cyanide.

Distillation Procedure

The following steps describe the distillation process using distillation apparatus* and cyanide glassware* offered by the manufacturer:

1. Set up the distillation apparatus for cyanide recovery, leaving off the thistle tube. Refer to the *Distillation Apparatus Manual*. Turn on the water and make certain it is flowing steadily through the condenser.
2. Fill the distillation apparatus cylinder to the 50-mL mark with 0.25 N Sodium Hydroxide Standard Solution*.
3. Fill a clean 250-mL graduated cylinder to the 250-mL mark with sample and pour it into the distillation flask. Place a stirring bar into the flask and attach the thistle tube.
4. Arrange the vacuum system as shown in the Distillation Apparatus Manual, but do not connect the vacuum tubing to the gas bubbler. Turn on the water to the aspirator to full flow and adjust the flow meter to 0.5 SCFH.
5. Connect the vacuum tubing to the gas bubbler, making certain that air flow is maintained (check the flow meter) and that air is bubbling from the thistle tube and the gas bubbler.
6. Turn the power switch on and set the stir control to 5. Using a 50-mL graduated cylinder, pour 50 mL of 19.2 N Sulfuric Acid Standard Solution* through the thistle tube and into the distillation flask.
7. Using a water bottle, rinse the thistle tube with a small amount of deionized water.
8. Allow the solution to mix for three minutes; then add 20 mL Magnesium Chloride Reagent* through the thistle tube and rinse again. Allow the solution to mix for 3 more minutes.
9. Verify that there is a constant flow of water through the condenser.
10. Turn the heat control to 10.
11. Carefully monitor the distillation flask at this point in the procedure. Once the sample begins to boil, slowly lower the air flow to 0.3 SCFH. If the contents of the distillation flask begin to back up through the thistle tube, increase the air flow by adjusting the flow meter until the contents do not back up through the thistle tube. Boil the sample for one hour.
12. After one hour, turn off the still, but maintain the air flow for 15 minutes more.

* See [Optional Reagents and Apparatus on page 8](#).

13. After 15 minutes, remove the rubber stopper on the 500-mL vacuum flask to break the vacuum and turn off the water to the aspirator. Turn off the water to the condenser.
14. Remove the gas bubbler/cylinder assembly from the distillation apparatus. Separate the gas bubbler from the cylinder and pour the contents of the cylinder into a 250-mL, Class A volumetric flask. Rinse the gas bubbler, cylinder and J-tube connector with deionized water and add the washings to the volumetric flask.
15. Fill the flask to the mark with deionized water and mix thoroughly. Neutralize the contents of the flask and analyze for cyanide.

Accuracy Check

Standard Solutions Method

CAUTION

Cyanides and their solutions, and the hydrogen cyanide liberated by acids, are very poisonous. Both the solutions and the gas can be absorbed through the skin.

Prepare a 100 mg/L cyanide stock solution weekly as follows:

1. Dissolve 0.2503 grams of potassium cyanide in deionized water and dilute to 1000 mL.
2. Immediately before use, prepare a 0.200 mg/L cyanide working solution by diluting 2.00 mL of the 100 mg/L stock solution to 1000 mL using deionized water.
3. To adjust the calibration curve using the reading obtained with the 0.200 mg/L standard solution, press **OPTIONS>MORE** on the current program menu. Press **STANDARD ADJUST**.
4. Press **ON**. Press **ADJUST** to accept the displayed concentration (the value depends on the selected units). If an alternate concentration is used, press the number in the box to enter the actual concentration, then press **OK**. Press **ADJUST**.

Summary of Method

The Pyridine-Pyrazalone method used for measuring cyanide gives an intense blue color with free cyanide. A sample distillation is required to determine cyanide from transition and heavy metal cyanide complexes. Test results are measured at 612 nm.

Consumables and Replacement Items

Required Reagents

Description	Quantity/Test	Unit	Cat. No.
Cyanide Reagent Set, includes:	—	—	24302-00
(1) CyaniVer® 3 Cyanide Reagent Powder Pillow	1	100/pkg	21068-69
(1) CyaniVer® 4 Cyanide Reagent Powder Pillow	1	100/pkg	21069-69
(1) CyaniVer® 5 Cyanide Reagent Powder Pillow	1	100/pkg	21070-69

Consumables and Replacement Items, continued

Required Apparatus

Description	Quantity/Test	Unit	Cat. No.
Cylinder, graduated, 10-mL	1	each	508-38
Sample Cells, 1-inch square, 10-mL, matched pair	2	2/pkg	24954-02
Stopper, poly, hollow	—	6/pkg	14480-00

Recommended Standards

Description	Unit	Cat. No.
Potassium Cyanide, ACS	125 g	767-14
Water, deionized	4 L	272-56

Optional Reagents and Apparatus

Description	Cat. No.
Acetic Acid	100-49
Ascorbic Acid	6138-26
Balance, analytical	28014-01
Bromine Water	2211-20
Buffer Solution, pH 4	12223-49
Filter Paper	1894-57
Funnel	1083-67
Hexane Solution	14478-49
HexaVer Chelating Reagent Powder Pillow	243-99
Hydrochloric Acid Standard Solution, 2.5 N	1418-32
Hydrogen Sulfide Test Paper	25377-33
m-Nitrophenol Indicator Solution, 10-g/L	2476-32
Magnesium Chloride Reagent	14762-53
Potassium Iodide Solution, 30-g/L	343-32
Sodium Arsenite Solution, 5-g/L	1047-32
Sodium Hydroxide Standard Solution, 0.25 N	14763-53
Sodium Hydroxide Standard Solution, 5.0 N	2450-53
Starch Indicator Solution	349-32
Sulfuric Acid Standard Solution, 19.2 N	2038-49
Cyanide Glassware	22658-00
Distillation Apparatus, 115 VAC	22744-00
Distillation Apparatus, 230 VAC	22744-02
Distillation Apparatus Set	22653-00



FOR TECHNICAL ASSISTANCE, PRICE INFORMATION AND ORDERING:
 In the U.S.A. – Call toll-free 800-227-4224
 Outside the U.S.A. – Contact the HACH office or distributor serving you.
 On the Worldwide Web – www.hach.com; E-mail – techhelp@hach.com

HACH COMPANY
 WORLD HEADQUARTERS
 Telephone: (970) 669-3050
 FAX: (970) 669-2932

Cyanuric Acid

Method 8139

Turbidimetric Method

Powder Pillows

(5 to 50 mg/L)

Scope and Application: For water



Test Preparation

Before starting the test:

Filter highly turbid samples with filter paper and a funnel.

Clean sample cells with soap, water, and a brush soon after each test to avoid a build-up of film on the sample cell.

Collect the following items:

Quantity

Bottle, mixing, square, glass

1

Cyanuric Acid 2 Reagent Powder Pillow

1

Sample cells, 1-inch square, 10 mL

2

Note: Reorder information for consumables and replacement items is on page 3.

Powder Pillows

Method 8139



1. Press **STORED PROGRAMS**.

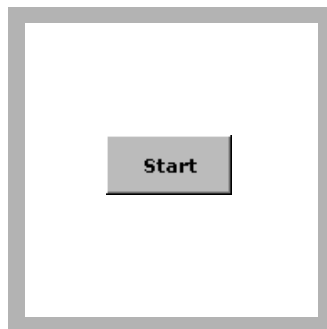

2. Select the test.

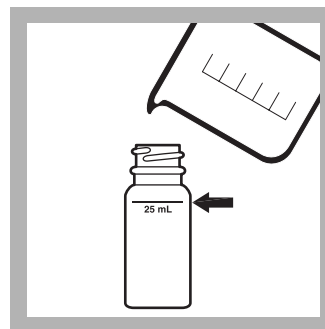

3. Fill a mixing bottle with 25 mL of sample.

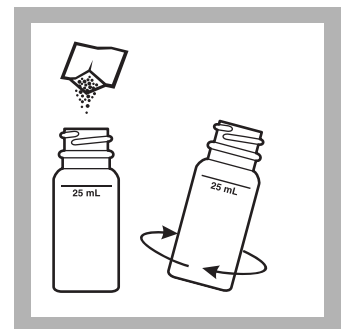

4. **Prepared Sample:** Add the contents of one Cyanuric Acid 2 Reagent Powder Pillow. Swirl to mix.

After adding the reagent, a white turbidity will form if cyanuric acid is present.

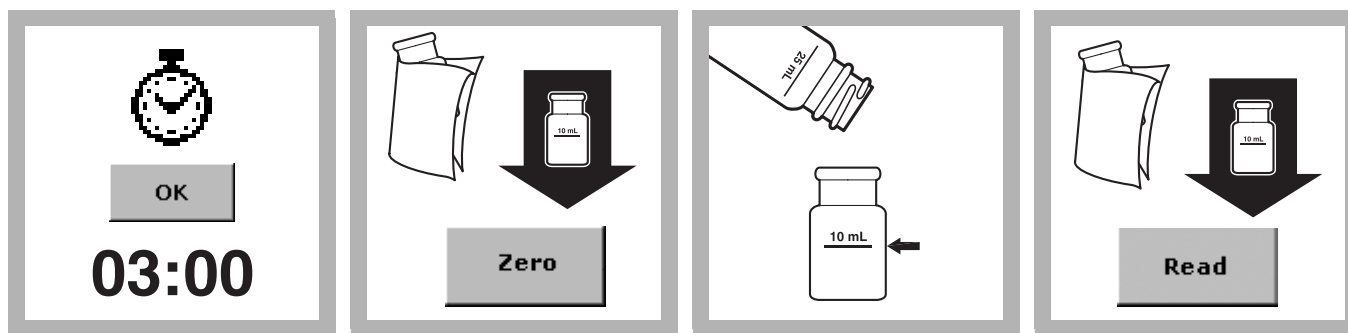

5. Press **TIMER>OK.**

A 3-minute reaction period will begin.

6. Blank Preparation:

Fill a square sample cell with 10 mL of sample and insert it in the cell holder with the fill line facing right.

Press **ZERO**.

The display will show:

0 mg/L Cyan Acid

7. When the timer expires, fill a second square sample cell with 10 mL of prepared sample.

8. Within seven minutes after the timer expires, place the prepared sample into the cell holder with the fill line facing right.

Press **READ**. Results are in mg/L Cyan Acid.

Sample Collection, Storage, and Preservation

Collect samples in clean plastic or glass bottles. Samples must be analyzed within 24 hours.

Accuracy Check

Standard Solution Method

1. Dissolve 1.000 gram of cyanuric acid in 1 liter of deionized water to make a 1000-mg/L solution. Cyanuric acid is difficult to dissolve; it may take several hours to completely dissolve. This solution is stable for several weeks.
2. Dilute 3.00 mL of the 1000-mg/L solution to 100 mL with deionized water to make a 30-mg/L solution. Prepare fresh daily. Testing the 30-mg/L solution should give test results of about 30 mg/L cyanuric acid.
3. To adjust the calibration curve using the reading obtained with the standard solution, press **OPTIONS>MORE** on the current program menu. Press **STANDARD ADJUST**.
4. Press **ON**. Press **ADJUST** to accept the displayed concentration. If an alternate concentration is used, press the number in the box to enter the actual concentration, then press **OK**. Press **ADJUST**.

Summary of Method

The test for Cyanuric Acid uses the turbidimetric method. Cyanuric Acid 2 Reagent precipitates any Cyanuric Acid present and holds it in suspension. The amount of turbidity caused by the suspended particles is directly proportional to the amount of cyanuric acid present. Test results are measured at 480 nm.

Consumables and Replacement Items

Required Reagents

Description	Quantity/Test	Unit	Cat. No.
Cyanuric Acid 2 Reagent Powder Pillow	1	50/pkg	2460-66

Required Apparatus

Description	Quantity/Test	Unit	Cat. No.
Bottle, mixing, square, with 25 mL mark	1	each	17042-00
Sample Cell, 1-inch square, 10-mL matched pair	2	2/pkg	24954-02

Recommended Standards

Description	Unit	Cat. No.
Cyanuric Acid	25 g	7179-24
Water, deionized	4 L	272-56

Optional Reagents

Description	Cat. No.
Filter, paper for funnel	1894-57
Funnel	1083-67



FOR TECHNICAL ASSISTANCE, PRICE INFORMATION AND ORDERING:

In the U.S.A. – Call toll-free 800-227-4224
Outside the U.S.A. – Contact the HACH office or distributor serving you.
On the Worldwide Web – www.hach.com; E-mail – techhelp@hach.com

HACH COMPANY
WORLD HEADQUARTERS
Telephone: (970) 669-3050
FAX: (970) 669-2932

★ Method 8029

SPADNS Method¹

Reagent Solution or AccuVac[®] Ampuls

(0.02 to 2.00 mg/L F⁻)

Scope and Application: For water, wastewater and seawater; USEPA accepted for reporting for drinking and wastewater analyses (distillation required; see *Distillation on page 4*)²

¹ Adapted from *Standard Methods for the Examination of Water and Wastewater, 4500-F B & D*

² Procedure is equivalent to USEPA method 340.1 for drinking water and wastewater.



Test Preparation

Before starting the test:

The sample and deionized water should be at the same temperature (± 1 °C). Temperature adjustments may be made before or after reagent addition.

SPADNS Reagent is toxic and corrosive. Use care while handling the reagent.

For best results, measure the volume of SPADNS Reagent as accurately as possible.

If the instrument displays Over Measure Range!, dilute a fresh sample with an equal volume of deionized water and repeat the test, using this solution in step 3. Multiply the result by 2.

Collect the following items:

Quantity

	Quantity
Solution Test:	
SPADNS Reagent Solution	4 mL
Deionized Water	10 mL
Pipet, volumetric, 2-mL	1
Pipet, volumetric, 10-mL	1
Pipet Filler Bulb	1
Sample cells, 1-in. square, 10-mL	2
Thermometer, -10 to 110 °C	1
AccuVac Test:	
SPADNS Fluoride Reagent AccuVac [®] Ampuls	2
Deionized Water	40 mL
Beaker, 50-mL	1

Note: Reorder information for consumables and replacement items is on page 5.

Important Note: SPADNS Reagent contains sodium arsenite. Final solutions will contain arsenic (D004) in sufficient concentration to be regulated as a hazardous waste for Federal RCRA. Refer to the MSDS for disposal instructions.

Using SPADNS Reagent

Method 8029



1. Press **STORED PROGRAMS**.

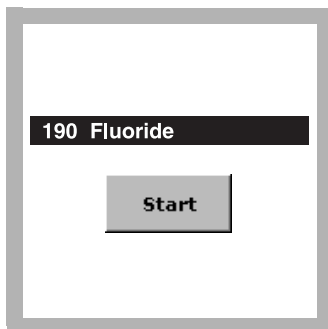

2. Select the test.

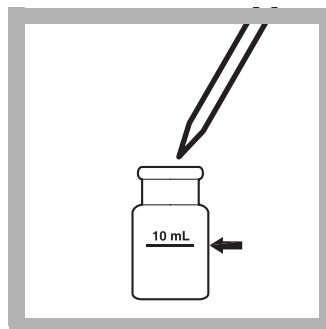

3. **Prepared Sample:**
Pipet 10.0 mL of sample into a dry square sample cell.

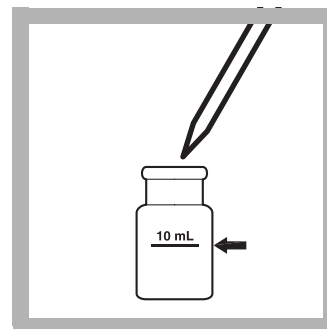

4. **Blank Preparation:**
Pipet 10.0 mL of deionized water into a second dry square sample cell.

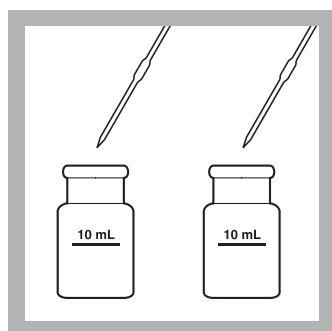

5. Carefully pipet 2.0 mL of SPADNS Reagent into each cell. Swirl to mix.

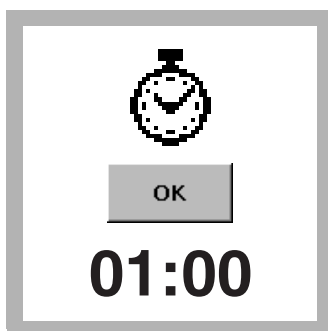

6. Press **TIMER>OK**.
A one-minute reaction period will begin.

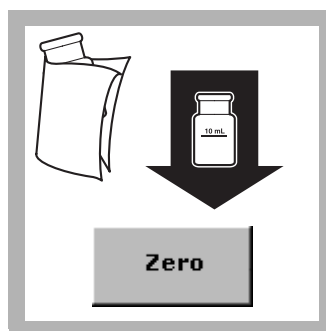

7. When the timer expires, insert the blank into the cell holder with the fill line facing right.
Press **ZERO**.

The display will show:

0.00 mg/L F⁻

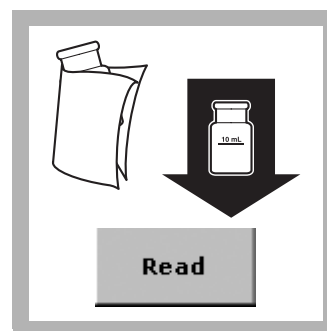

8. Insert the prepared sample into the cell holder with the fill line facing right.
Press **READ**. Results are in mg/L F⁻.

AccuVac[®] Ampul

Method 8029

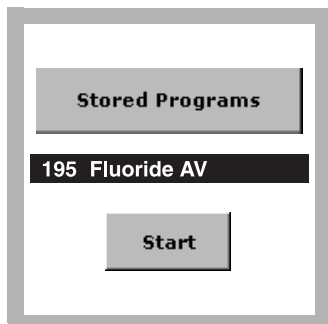

1. Select the test.

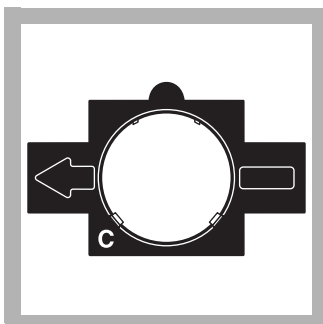

2. Insert Adapter C.



3. Prepared Sample:
Collect at least 40 mL of sample in a 50-mL beaker. Fill one SPADNS Fluoride Reagent AccuVac Ampul with sample. Keep the tip immersed while the Ampul fills completely.

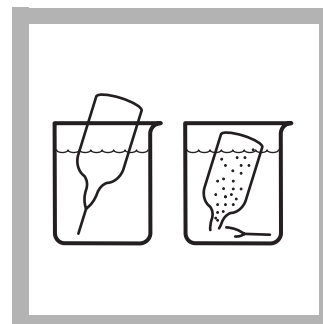

4. Blank Preparation:
Pour at least 40 mL of deionized water into a second beaker. Fill a second Ampul with deionized water. Keep the tip immersed while the Ampul fills completely.

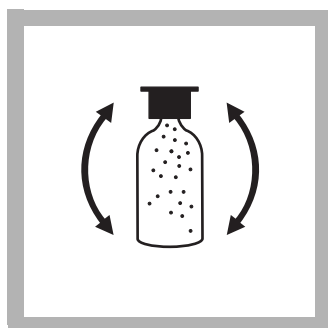

5. Quickly invert both Ampuls several times to mix.



6. Press **TIMER>OK**.
A one-minute reaction period will begin.

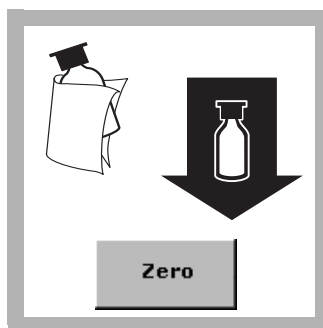

7. When the timer expires, insert the blank into the cell holder. Press **ZERO**.
The display will show:
0.00 mg/L F⁻



8. Insert the AccuVac Ampul that contains the sample into the cell holder. Press **READ**. Results are in mg/L F⁻.

Interferences

This test is sensitive to small amounts of interference. Glassware must be very clean (acid rinse before each use). Repeat the test with the same glassware to ensure that results are accurate.

Table 1 Interfering Substances and Levels

Interfering Substance	Interference Levels and Treatments
Alkalinity (as CaCO ₃)	At 5000 mg/L it causes a -0.1 mg/L F ⁻ error.
Aluminum	At 0.1 mg/L it causes a -0.1 mg/L F ⁻ error. To check for interferences from aluminum, read the concentration one minute after reagent addition, then again after 15 minutes. An appreciable increase in concentration suggests aluminum interference. Waiting 2 hours before making the final reading will eliminate the effect of up to 3.0 mg/L aluminum.
Chloride	At 7000 mg/L it causes a +0.1 mg/L F ⁻ error.
Chlorine	SPADNS Reagent contains enough arsenite to eliminate interference up to 5 mg/L chlorine. For higher chlorine levels, add one drop of Sodium Arsenite Solution ¹ to 25 mL of sample for each 2 mg/L of Chlorine.
Iron, ferric	At 10 mg/L it causes a -0.1 mg/L F ⁻ error.
Phosphate, ortho	At 16 mg/L it causes a +0.1 mg/L F ⁻ error.
Sodium Hexametaphosphate	At 1.0 mg/L it causes a +0.1 mg/L F ⁻ error.
Sulfate	At 200 mg/L it causes a +0.1 mg/L F ⁻ error.

¹ See [Optional Reagents and Apparatus on page 6](#).

Distillation

Most interferences can be eliminated by distilling the sample from an acid solution as described below:

1. Set up the distillation apparatus for general purpose distillation. Refer to the Distillation Apparatus manual for proper assembly. Use a 125-mL Erlenmeyer flask to collect the distillate.
2. Turn on the water and maintain a steady flow through the condenser.
3. Measure 100 mL of sample into the distillation flask using a 100-mL graduated cylinder. Add a magnetic stir bar and 5 glass beads.
4. Turn the stirrer power switch on. Turn the stir control to 5.
5. Using a 250-mL graduated cylinder, carefully add 150 mL of StillVer[®] Distillation Solution into the flask. (StillVer Distillation Solution is a 2:1 mixture of concentrated sulfuric acid and water.)

Note: When distilling samples with high amounts of chloride, add 5 mg of Silver Sulfate* to the sample for every mg/L of chloride in the sample.

6. With the thermometer in place, turn the heat control to 10. The yellow pilot lamp indicates the heater is on.
7. When the temperature reaches 180 °C or when 100 mL of distillate has been collected, turn the still off (requires about 1 hour).
8. Dilute the distillate to a volume of 100 mL, if necessary. The distillate may now be analyzed by the SPADNS or the fluoride ion-selective electrode method.

* See [Optional Reagents and Apparatus on page 6](#).

Sample Collection, Storage, and Preservation

Samples may be stored in glass or plastic bottles for at least seven days when cooled to 4 °C (39 °F) or lower. Warm samples to room temperature before analysis.

Accuracy Check

Standard Solution Method

A variety of standard solutions covering the entire range of the test is available. Use these instead of sample to verify technique.

Minor variations between lots of reagent become measurable above 1.5 mg/L. While results in this region are usable for most purposes, better accuracy may be obtained by diluting a fresh sample 1:1 with deionized water and retesting. Multiply the result by 2.

To adjust the calibration curve using the reading obtained with a standard solution:

1. Press **OPTIONS>MORE** on the current program menu. Press **STANDARD ADJUST>OFF**.
2. Press **ON**. Press **ADJUST** to accept the displayed concentration (the value depends on the selected units). If an alternate concentration is used, press the number in the box to enter the actual concentration, then press **OK**. Press **ADJUST**.

Summary of Method

The SPADNS Method for fluoride determination involves the reaction of fluoride with a red zirconium-dye solution. The fluoride combines with part of the zirconium to form a colorless complex, thus bleaching the red color in an amount proportional to the fluoride concentration. This method is accepted by the EPA for NPDES and NPDWR reporting purposes when the samples have been distilled. Seawater and wastewater samples require distillation. Test results are measured at 580 nm.

Consumables and Replacement Items

Required Reagents

Description	Quantity/Test	Unit	Cat. No.
SPADNS Reagent Solution	4 mL	500 mL	444-49
OR			
SPADNS Fluoride Reagent AccuVac® Ampuls	2	25/pkg	25060-25
Water, deionized	10 mL	4 L	272-56

Required Apparatus (Solution)

Description	Quantity/Test	Unit	Cat. No.
Pipet Filler, safety bulb	1	each	14651-00
Pipet, volumetric, Class A, 2.00-mL	1	each	14515-36
Pipet, volumetric, Class A, 10.00-mL.	1	each	14515-38
Sample Cells, 1-inch square, 10 mL, matched pair	2	2/pkg	24954-02
Thermometer, -10 to 110 °C	1	each	1877-01

Fluoride (0.02 to 2.00 mg/L F⁻)

Required Apparatus (AccuVac)

Description	Quantity/Test	Unit	Cat. No.
Adapter, 1-inch round, for AccuVac Ampuls	1	each	LZV584
Beaker, 50-mL	1	each	500-41H

Recommended Standards

Description	Unit	Cat. No.
Fluoride Standard Solution, 0.2-mg/L F ⁻	500 mL	405-02
Fluoride Standard Solution, 0.5-mg/L F ⁻	500 mL	405-05
Fluoride Standard Solution, 0.8-mg/L F ⁻	500 mL	405-08
Fluoride Standard Solution, 1.0-mg/L F ⁻	1000 mL	291-53
Fluoride Standard Solution, 1.0-mg/L F ⁻	500 mL	291-49
Fluoride Standard Solution, 1.2-mg/L F ⁻	500 mL	405-12
Fluoride Standard Solution, 1.5-mg/L F ⁻	500 mL	405-15
Fluoride Standard Solution, 2.0-mg/L F ⁻	500 mL	405-20
Fluoride Standard Solution, 100-mg/L F ⁻	500 mL	232-49
Standard, Drinking Water, Mixed Parameter, Inorganic for F ⁻ , NO ₃ , PO ₄ , SO ₄	500 mL	28330-49

Consumables and Replacement Items (continued)

Distillation Reagents and Apparatus

Description	Quantity/Test	Unit	Cat. No.
Cylinder, graduated, 100-mL	1	each	508-42
Cylinder, graduated, 250-mL	1	each	508-46
Distillation Heater and Support Apparatus Set, 115 VAC, 50/60 Hz	1	each	22744-00
AND			
Distillation Heater and Support Apparatus Set, 230 VAC, 50/60 Hz	1	each	22744-02
OR			
Distillation Apparatus Set, General Purpose	1	each	22653-00
Flask, Erlenmeyer, 125-mL	1	each	20897-43
Glass Beads	1	100/pkg	2596-00
StillVer [®] Distillation Solution	varies	500 mL	446-49
Stir Bar, magnetic	1	each	10764-16

Optional Reagents and Apparatus

Description	Cat. No.
Silver Sulfate	334-14
Sodium Arsenite Solution, 0.5 g/L	1047-32



FOR TECHNICAL ASSISTANCE, PRICE INFORMATION AND ORDERING:
In the U.S.A. – Call toll-free 800-227-4224
Outside the U.S.A. – Contact the HACH office or distributor serving you.
On the Worldwide Web – www.hach.com; E-mail – techhelp@hach.com

HACH COMPANY
WORLD HEADQUARTERS
Telephone: (970) 669-3050
FAX: (970) 669-2932

Method 8110

MBTH Method¹

Powder Pillows

(3 to 500 µg/L)

Scope and Application: For water

¹ Adapted from Matthews, T.G. and Howell, T.C., *Journal of the Air Pollution Control Association*, 31 (11) 1181-1184 (1981).



Test Preparation

Before starting the test:

Analyze samples immediately. Do not preserve for later analysis.

Wash glassware with Chromic Acid Cleaning Solution¹ to remove trace contaminants.

Time and temperature are very important in this test. The sample should be 25 ±1°C, and the times specified in steps must be followed precisely. A temperature-controlled water bath is recommended for best accuracy

Obtain formaldehyde-free water by distilling water from alkaline permanganate (4 g Sodium Hydroxide¹, 2 g Potassium Permanganate¹ per 500 mL of water). Discard the first 50–100 mL of distillate

¹ See [Optional Reagents and Apparatus on page 5](#).

Collect the following items:

Quantity

Developing Solution for LR Formaldehyde	5 mL
MBTH Powder Pillows	2
Clippers	1
Cylinder, graduated mixing, 50-mL	2
Pipet, serological, 5-mL	1
Pipet Filler	1
Sample Cells, 1-inch square glass, 10-mL	2

Note: Reorder information for consumables and replacement items is on [page 5](#).

Powder Pillows Method 8110



1. Press **STORED PROGRAMS**.

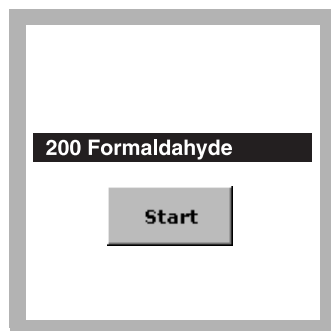

2. Select the test.

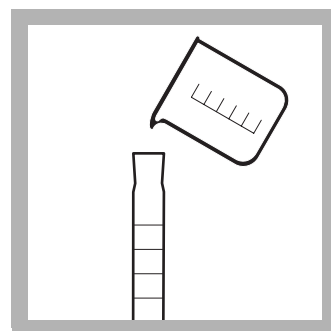

3. **Prepared Sample:** Accurately measure 25 mL of sample in a 50-mL mixing cylinder.

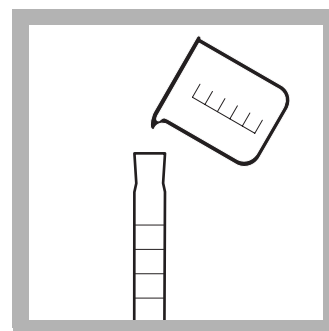

4. **Blank Preparation:** Accurately measure 25 mL of formaldehyde-free water in a second 50-mL mixing cylinder.

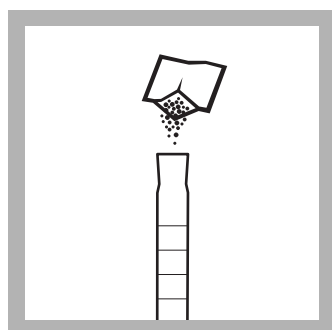

5. Add the contents of one MBTH Powder Pillow to the blank. Stopper the cylinder.

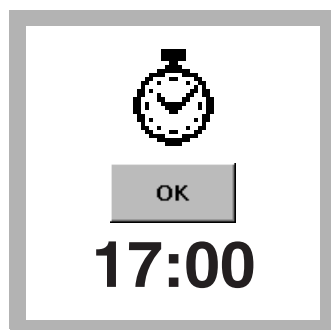

6. Press **TIMER>OK**. A 17-minute reaction period will begin. Proceed with step 7 immediately after the timer starts. Complete steps 7-12 during the reaction period, at the times specified.

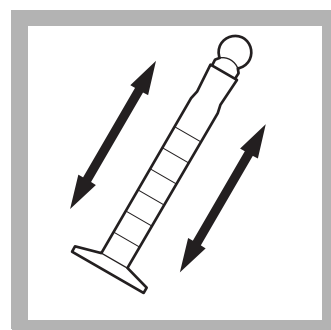

7. Immediately after the reaction period starts, shake the blank sample cylinder vigorously for 20 seconds. **Do not wait for the timer to expire.**

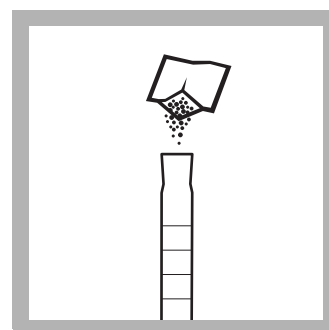

8. Add the contents of one MBTH Powder Pillow to the prepared sample when the timer displays **15:00**.

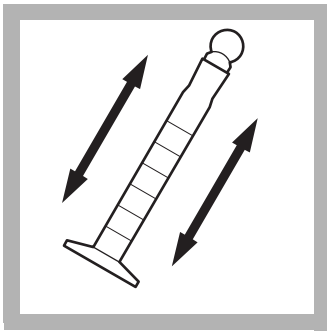

9. Stopper the cylinder and shake vigorously for 20 seconds.

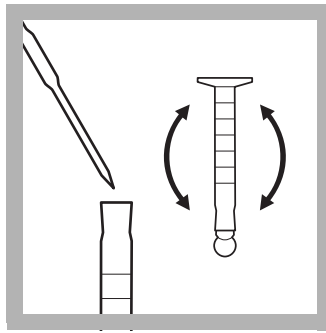

10. Add 2.5 mL of Developing Solution for Low Range Formaldehyde to the blank when the timer shows **12:00**. Stopper and invert to mix.

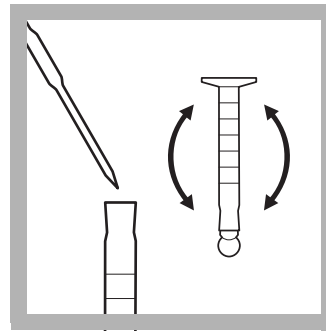

11. Add 2.5 mL of Developing Solution for Low Range Formaldehyde to the prepared sample when the timer shows **10:00**. Stopper and invert to mix.

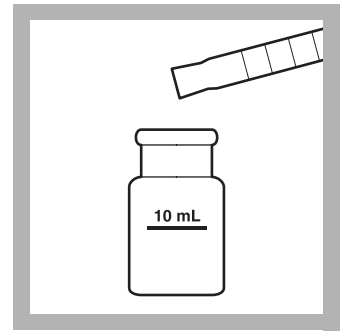

12. Just before the timer shows **2:00**, pour at least 10 mL of the blank into the square sample cell. Pour the solution slowly to avoid bubble formation on the cell walls. If bubbles form, swirl to dislodge them.



13. Immediately wipe the blank and insert it into the cell holder with the fill line facing right.

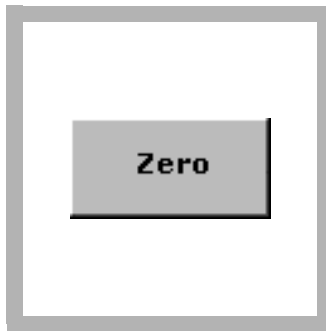

14. When the timer shows **2:00**, press **ZERO**. The display will show:
0 µg/L CH₂O

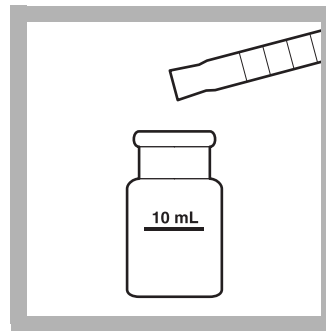

15. Pour at least 10 mL of the prepared sample into a sample cell.

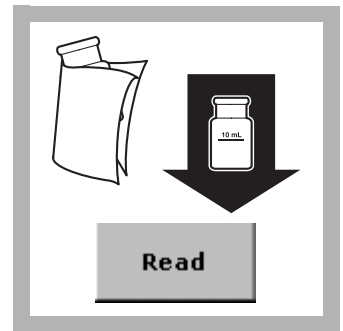

16. Wipe the cell and insert it into the cell holder with the fill line facing right. When the timer expires, press **READ**. Note the results in µg/L CH₂O.

Interferences

Table 1 Interfering Substances and Levels

Interfering Substance	Interference Levels and Treatments
Acetate	Greater than 1000 mg/L
Aldehydes (other)	Positive interference at all levels
Ammonium (as N)	Greater than 10 mg/L
Aniline	Greater than 10 mg/L
Bicarbonate	Greater than 1000 mg/L
Calcium	Greater than 3500 mg/L
Carbonate	Greater than 500 mg/L
Chloride	Greater than 5000 mg/L
Copper	Greater than 1.6 mg/L

Table 1 Interfering Substances and Levels (continued)

Interfering Substance	Interference Levels and Treatments
Cyclohexylamine	Greater than 250 mg/L
Ethanolamine	Greater than 33 mg/L
Ethylenediamine	Greater than 1.5 mg/L
Glucose	Greater than 1000 mg/L
Glycine	Greater than 1000 mg/L
Iron (Fe ³⁺)	Greater than 12 mg/L
Lead	Greater than 100 mg/L
Manganese	Greater than 500 mg/L
Mercury	Greater than 70 mg/L
Morpholine	Greater than 0.36 mg/L
Nitrate	Greater than 1000 mg/L
Nitrite	Greater than 8 mg/L
Phenol	Greater than 1050 mg/L
Phosphate	Greater than 200 mg/L
Silica	Greater than 40 mg/L
Sulfate	Greater than 10,000 mg/L
Urea	Greater than 1000 mg/L
Zinc	Greater than 1000 mg/L

Accuracy Check

Standard Additions Method (Sample Spike)

1. After reading test results, leave the sample cell (unspiked sample) in the instrument.
2. Press **OPTIONS>MORE**. Press **STANDARD ADDITIONS**. A summary of the standard additions procedure will appear.
3. Press **OK** to accept the default values for standard concentration, sample volume, and spike volumes. Press **EDIT** to change these values. After values are accepted, the unspiked sample reading will appear in the top row. See the user manual for more information.
4. Snap the neck off a Formaldehyde Voluette[®] Ampule Standard, 4000-mg/L CH₂O.
5. Use a TenSette[®] Pipet to add 0.2 mL of the standard to a 100-mL volumetric Class A flask. Dilute to volume with formaldehyde-free water and mix well. Prepare daily. This is an 8000-µg/L (8-mg/L) formaldehyde standard.
6. Prepare three sample spikes. Fill three 50-mL mixing cylinders* with 25 mL of sample. Use the TenSette Pipet to add 0.1 mL, 0.2 mL, and 0.3 mL of 8000-µg/L standard, respectively, to each sample and mix thoroughly.
7. Analyze each sample spike as described in the procedure above, starting with the 0.1 mL sample spike. Accept each standard additions reading by pressing **READ**. Each addition should reflect approximately 100% recovery.

* See [Optional Reagents and Apparatus on page 5](#).

8. After completing the sequence, press **GRAPH** to view the best-fit line through the standard additions data points, accounting for the matrix interferences. Press **IDEAL LINE** to view the relationship between the sample spikes and the "Ideal Line" of 100% recovery

Standard Solution Method

Prepare a 320-µg/L Formaldehyde Standard Solution by pipetting 1.0 mL of the 8000-µg/L solution into a 50-mL mixing cylinder. Dilute to 25.0 mL with formaldehyde-free water. Run the test directly on this sample.

Summary of Method

Formaldehyde reacts with MBTH (3-methyl-2-benzothiazoline hydrazone) and a developing solution to form a blue color in proportion to the formaldehyde concentration. Test results are measured at 630 nm.

Consumables and Replacement Items

Required Reagents

Description	Quantity/Test	Unit	Cat. No.
Formaldehyde Reagent Set (100 tests), includes:	—	—	22577-00
Developing Solution for LR Formaldehyde	5 mL	500 mL	22572-49
MBTH Powder Pillows	2	100/pkg	22571-69

Required Apparatus

Description	Quantity/Test	Unit	Cat. No.
Clippers	1	each	968-00
Cylinder, graduated mixing, 50-mL	2	each	1896-41
Pipet, serological, 5-mL	1	each	532-37
Pipet Filler, safety bulb	1	each	14651-00
Sample Cells, 1-inch square, 10 mL, matched pair	2	2/pkg	24954-02

Recommended Standards

Description	Unit	Cat. No.
Formaldehyde Standard Solution, 10-mL Voluette® Ampule, 4000-mg/L	16/pkg	22573-10

Optional Reagents and Apparatus

Description	Cat. No.
Chromic Acid Cleaning Solution, 500 mL	1233-49
Potassium Permanganate, 5 lb (2.27 kg)	769-05
Sodium Hydroxide ACS 500g	187-34



FOR TECHNICAL ASSISTANCE, PRICE INFORMATION AND ORDERING:

In the U.S.A. – Call toll-free 800-227-4224
Outside the U.S.A. – Contact the HACH office or distributor serving you.
On the Worldwide Web – www.hach.com; E-mail – techhelp@hach.com

HACH COMPANY
WORLD HEADQUARTERS
Telephone: (970) 669-3050
FAX: (970) 669-2932

Method 8030

Calcium and Magnesium; Calmagite Colorimetric Method
(0.05 to 4.00 mg/L Ca and Mg as CaCO₃)

Scope and Application: For water, wastewater, and seawater



Test Preparation

Before starting the test:

For the most accurate magnesium test results, keep the sample temperature between 21–29 °C (70–84 °F).

The test will detect any calcium or magnesium contamination in the mixing cylinder, measuring droppers, or sample cells. To test cleanliness, repeat the test until results are consistent.

Total hardness in mg/L equals mg/L Ca as CaCO₃ plus mg/L Mg as CaCO₃.

Remaining traces of EDTA or EGTA from previous tests will give erroneous results. Rinse sample cells thoroughly before using.

Collect the following items:

Quantity

Alkali Solution for Calcium and Magnesium test	1 mL
Calcium and Magnesium Indicator Solution	1 mL
EDTA Solution, 1 M	1 drop
EGTA Solution	1 drop
Cylinder, 100-mL, graduated mixing	1
Dropper, measuring, 0.5 and 1.0 mL	2
Sample Cells, 1-inch square	3

Note: Reorder information for consumables and replacement items is on page 4.

Calmagite

Method 8030

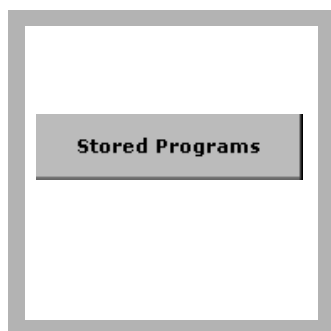

1. Press **STORED PROGRAMS**.



2. Select the test.

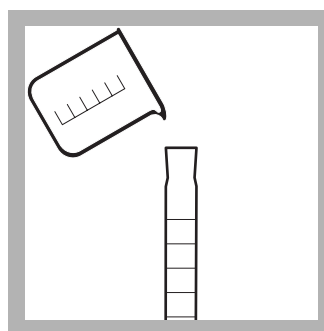

3. Pour 100 mL of sample into a 100-mL graduated mixing cylinder.

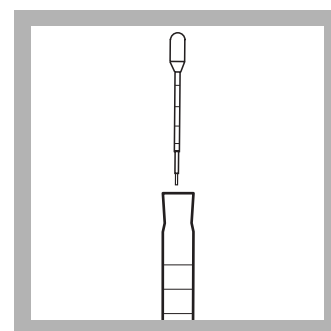

4. Add 1.0 mL of Calcium and Magnesium Indicator solution using a 1.0 mL measuring dropper.

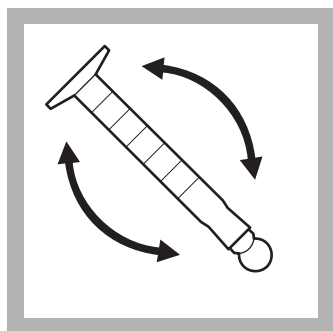

5. Stopper the cylinder and invert it several times.

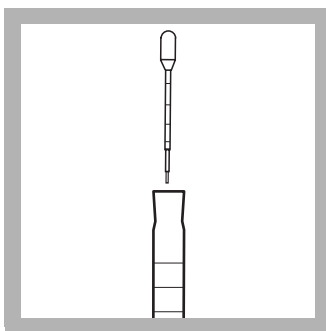

6. Add 1.0 mL of Alkali Solution for Calcium and Magnesium Test using a 1.0 mL measuring dropper.

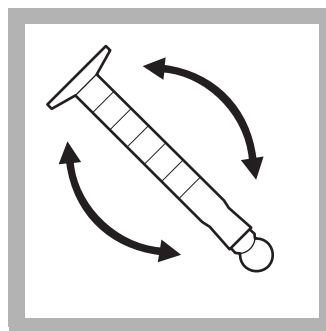

7. Stopper the cylinder and invert it several times.

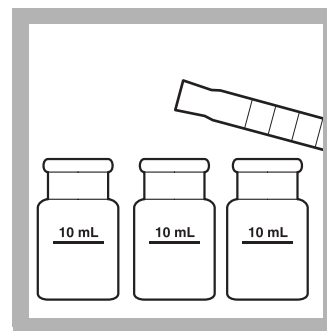

8. Pour 10 mL of the solution into each of **three** square sample cells.

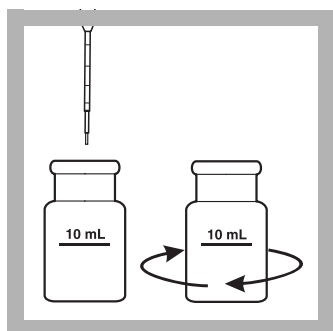

9. **Blank Preparation:** Add one drop of 1 M EDTA Solution to the **first** cell. Swirl to mix.

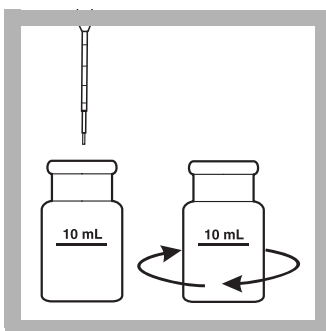

10. **Magnesium Sample:** Add one drop of EGTA Solution to the **second** cell. Swirl to mix.

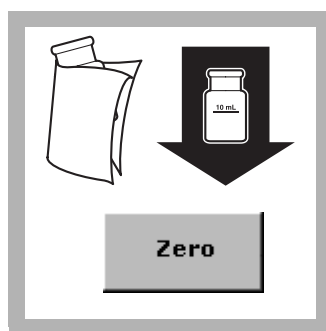

11. Insert the **blank** (first cell) into the cell holder with the fill line facing right. Press **ZERO**.

The display will show:

0.00 mg/L Mg CaCO₃

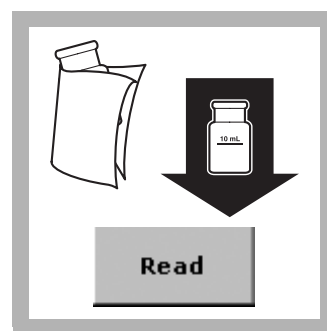

12. Insert the **magnesium sample** (second cell) into the cell holder with the fill line facing right.

Press **READ**. Results are in mg/L magnesium as calcium carbonate.

This value is the amount of magnesium in the sample expressed as CaCO₃.

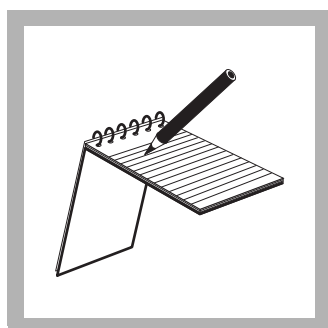

13. Do not remove the cell from the instrument. Record or store the magnesium results before proceeding with step 14.



14. Press **EXIT**.
Select the test.
Press **START**.

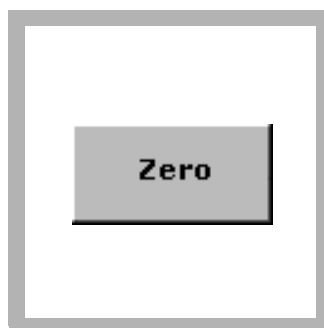

15. Press **ZERO**.
The display will show:
0.00 mg/L Ca CaCO₃
Remove the second cell.



16. Calcium Sample:
Insert the **third** cell into the cell holder with the fill line facing right.
Press **READ**. Results are in mg/L calcium as calcium carbonate.
This value is the amount of calcium in the sample expressed as CaCO₃.

Interferences

Table 1 Interfering Substances and Levels

Interfering Substance	Interference Levels and Treatments
Chromium (3 ⁺)	Above 0.25 mg/L
Copper (2 ⁺)	Above 0.75 mg/L
EDTA, chelated	Above 0.2 mg/L as CaCO ₃
EDTA or EGTA	Traces remaining in sample cells from previous tests will give erroneous results. Rinse cells thoroughly before using.
Iron (2 ⁺)	Above 1.4 mg/L
Iron (3 ⁺)	Above 2.0 mg/L
Manganese (2 ⁺)	Above 0.20 mg/L
Zinc (2 ⁺)	Above 0.050 mg/L
Ca >1.0 mg/L; Mg >0.25 mg/L	For the most accurate calcium test result, rerun the test on a diluted sample if the calcium is over 1.0 and the magnesium is over 0.25 mg/L as CaCO ₃ . No retesting is needed if either is below those respective concentrations.

Sample Collection, Storage, and Preservation

Collect samples in acid-washed plastic bottles. Adjust the sample pH to 2 or less with Nitric Acid* (about 5 mL per liter). Cool samples to 4 °C. Preserved samples can be stored up to six months. Before analysis, adjust the sample pH to between 3 and 8 with 5.0 N Sodium Hydroxide Standard Solution*. Correct the test results for volume additions.

* See [Optional Reagents and Apparatus](#) on page 4.

Summary of Method

The colorimetric method for measuring hardness supplements the conventional titrimetric method because the colorimetric method can measure very low levels of calcium and magnesium. Also, some metals (those listed the table above) that interfere in the titrimetric method may be inconsequential when diluting the sample to bring it within the range of this test. The indicator dye is calmagite, which forms a purplish-blue color in a strongly alkaline solution and changes to red when it reacts with free calcium or magnesium. Calcium and magnesium determinations are made by chelating calcium with EGTA to destroy any red color due to calcium and then chelating the calcium and magnesium with EDTA to destroy the red color due to both calcium and magnesium. By measuring the red color in the different states, calcium and magnesium concentrations are determined. Test results are measured at 522 nm.

Consumables and Replacement Items

Required Reagents

Description	Quantity/Test	Unit	Cat. No.
Hardness Reagent Set (100 tests), includes:	—	—	23199-00
Alkali Solution for Calcium and Magnesium test	1 mL	100 mL MDB	22417-32
Calcium and Magnesium Indicator Solution	1 mL	100 mL MDB	22418-32
EDTA Solution, 1 M	1 drop	50 mL SCDB	22419-26
EGTA Solution	1 drop	50 mL SCDB	22297-26

Required Apparatus

Description	Quantity/Test	Unit	Cat. No.
Cylinder, 100-mL, graduated mixing	1	each	1896-42
Dropper, measuring, 0.5 and 1.0 mL	2	20/pkg	21247-20
Sample Cells, 1-inch square, 10 mL, matched pair	3	2/pkg	24954-02

Optional Reagents and Apparatus

Description	Cat. No.
Nitric Acid	152-49
Sodium Hydroxide Standard Solution, 5.0 N	2450-32



FOR TECHNICAL ASSISTANCE, PRICE INFORMATION AND ORDERING:
In the U.S.A. – Call toll-free 800-227-4224
Outside the U.S.A. – Contact the HACH office or distributor serving you.
On the Worldwide Web – www.hach.com; E-mail – techhelp@hach.com

HACH COMPANY
WORLD HEADQUARTERS
Telephone: (970) 669-3050
FAX: (970) 669-2932

Hardness

Method 8374

Calcium and Magnesium;
Chlorophosphonazo Colorimetric Method
(8 to 1000 µg/L Ca and Mg as CaCO₃)

Scope and Application: For water, wastewater, and seawater



Test Preparation

Before starting the test:

For the most accurate magnesium test results, keep the sample temperature between 21–29 °C (70–84 °F).

The test will detect any calcium or magnesium contamination in the mixing cylinder, measuring droppers, or sample cells. To test cleanliness, repeat the test until results are consistent.

One mL of Chlorophosphonazo Solution* may be used instead of the solution pillow in step 5.

Total hardness in mg/L equals mg/L Ca as CaCO₃ plus mg/L Mg as CaCO₃.

Collect the following items:

Quantity

ULR Hardness Reagent Set	1
Chlorophosphonazo Indicator Solution Pillow	1
CDTA Solution	1 drop
Shears for opening powder pillow	1
Sample Cells, 1-inch square polystyrene, with cap	1

Note: Reorder information for consumables and replacement items is on page 4.

Chlorophosphonazo

Method 8374



1. Press
STORED PROGRAMS.



2. Select the test.

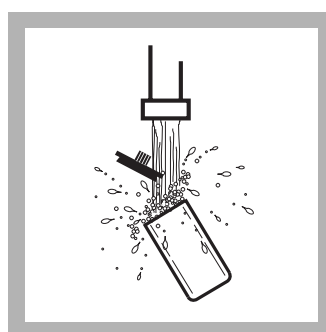

3. Rinse a plastic sample cell and the cap three times with the water to be tested. Do not allow the underside of the cap to come in contact with surfaces that may contaminate it.

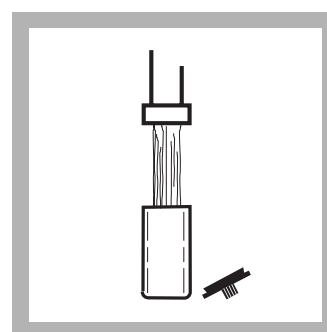

4. Fill the plastic sample cell to the 25-mL mark with sample.

Hardness (8 to 1000 µg/L Ca and Mg as CaCO₃)

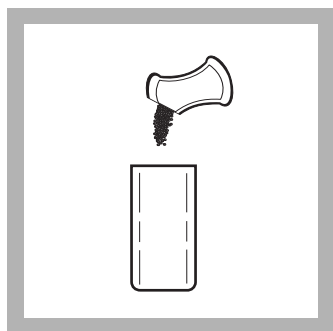

5. Add the contents of one Chlorophosphonazo Solution Pillow to the sample cell.

A small amount of solution may remain in the pillow. This will not affect results.



6. Cap the cell and swirl to mix.



7. Insert the cell into the cell holder.

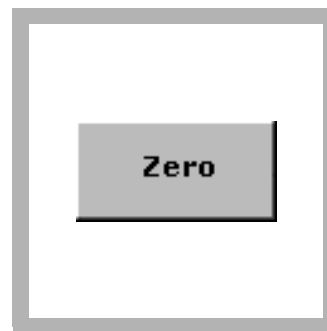

8. Press **ZERO**.

The display will show: 0 µg/L CaCO₃.

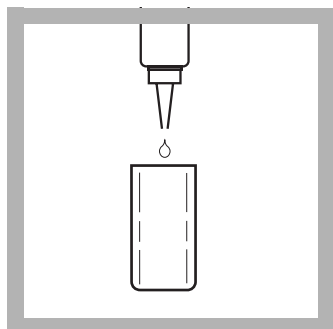

9. Remove the cell from the holder. Add one drop of CDTA Reagent for Ultra Low Range Hardness.

Complete steps 10-11 within 1-2 minutes.



10. Cap the cell and swirl to mix.



11. Insert the cell into the holder.

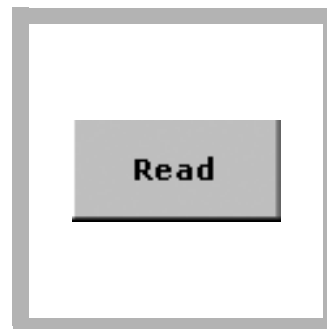

12. Press **READ**.

Results are in µg/L CaCO₃.

Interferences

Interference studies were conducted at various hardness levels between 0 and 500 µg/L as CaCO₃. Various cations and anions were evaluated at levels in the range appropriate for ultra pure water applications. An ion is said to interfere when the resulting concentration is changed by ± 10%.

Table 1 Interfering Substances and Levels

Interfering Substance	Interference Levels and Treatments
Aluminum	Negative interference above 150 µg/L
Ammonium	No interference at or below 1000 µg/L
Copper	Positive interference above 250 µg/L
Formaldehyde	No interference at or below 47,000 µg/L
Nitrate	Positive interference above 250 µg/L
Potassium	No interference at or below 1000 µg/L

Table 1 Interfering Substances and Levels (continued)

Interfering Substance	Interference Levels and Treatments
Silicon	Positive interference above 1000 µg/L
Sodium	Negative interference above 79,000 µg/L

Sample Collection, Storage, and Preservation

Do not use glass containers. Collect samples in clean plastic containers, preferably with screw-type closures. Rinse containers several times with the water to be analyzed before collecting the final sample. Seal to avoid contamination during transport. Analyze as soon as possible.

Accuracy Check

Standard Additions Method

1. Leave the unspiked sample in the sample cell compartment. Verify that the units displayed are in µg/L. Select standard additions mode by pressing **OPTIONS>MORE** and then **STANDARD ADDITIONS**.
2. Press **ENTER** to accept the default sample volume (mL), 25.
3. Obtain a Calcium Chloride Standard Solution, 20,000-µg/L as CaCO₃.
4. Use the TenSette Pipet to add 0.1 mL, 0.2 mL, and 0.3 mL of standard, respectively to three 25-mL samples and mix each thoroughly.
5. Analyze each standard addition sample as described above. Accept the standard additions reading by pressing **READ**. Each addition should reflect approximately 100% recovery.
6. After completing the sequence, press **GRAPH** to view the best-fit line through the standard additions data points, accounting for the matrix interferences. Press **IDEAL LINE** to view the relationship between the sample spikes and the "Ideal Line" of 100% recovery.

Standard Solution Method

1. Using the 0.50-mg/L (500-µg/L as CaCO₃) Calcium Chloride Standard Solution, perform the procedure using the standard in place of the sample.
2. To adjust the calibration curve using the reading obtained with the standard solution, press **OPTIONS>MORE** on the current program menu. Press **STANDARD ADJUST**.
3. Press **ON**. Press **ADJUST** to accept the displayed concentration. If an alternate concentration is used, press the number in the box to enter the actual concentration, then press **OK**. Press **ADJUST**.

Summary of Method

Calcium and magnesium combine equivalently with the Chlorophosphonazo III indicator to form a colored complex which absorbs light very strongly at 669 nm. One drop of the CDTA reagent breaks up this complex, and the resultant decrease in color is proportional to the amount of calcium and magnesium in the sample (as CaCO₃). Test results are measured at 669 nm.

Consumables and Replacement Items

Required Reagents

Description	Quantity/Test	Unit	Cat. No.
ULR Hardness Reagent Set (100 tests), includes: (1) 25895-99, (1) 25896-36, (1) 24102-01, (1) 24102-02	—	—	26031-00
OR			
ULR Hardness Reagent Set (500 tests), includes: (1) 25895-49, (2) 25896-36, (1) 24102-01, (1) 24102-02	—	—	26031-01
Chlorophosphonazo Indicator Solution Pillows	1	100/pkg	25895-99
CDTA Solution	1 drop	10 mL SCDB	25896-36

Required Apparatus

Description	Quantity/Test	Unit	Cat. No.
Shears	1	each	23694-00
Sample Cells, 1-inch polystyrene with cap	1	12/pkg	24102-12

Recommended Standards and Apparatus

Description	Unit	Cat. No.
Calcium Chloride Standard Solution, 20,000-µg/L as CaCO ₃	946 mL	21246-16
Calcium Chloride Standard Solution, 500-µg/L as CaCO ₃	946 mL	20580-16
Chlorophosphonazo Indicator Solution	500 mL	25895-49

Optional Reagents and Apparatus

Description	Cat. No.
Dispenser, 1.0-mL, Repipet Jr.	21113-02
Pipet, TenSette®, 0.1 to 1.0 mL	19700-01
Pipet Tips, for TenSette Pipet 19700-01, 50/pkg	21856-96



FOR TECHNICAL ASSISTANCE, PRICE INFORMATION AND ORDERING:
In the U.S.A. – Call toll-free 800-227-4224
Outside the U.S.A. – Contact the HACH office or distributor serving you.
On the Worldwide Web – www.hach.com; E-mail – techhelp@hach.com

HACH COMPANY
WORLD HEADQUARTERS
Telephone: (970) 669-3050
FAX: (970) 669-2932

Hardness, Total

Method 8374

Calcium and Magnesium; Chlorophosponazo Rapid Liquid Method

Pour-Thru Cell

ULR (4 to 1000 µg/L Ca & Mg as CaCO₃)

Scope and Application: For boiler, cooling, and ultra pure water



Test Preparation

Before starting the test:

Pre-clean the Pour-Thru Cell and all labware as specified in [Treating Analysis Labware on page 4](#).

Protect the Pour-Thru Cell from contamination when not in use by inverting a small beaker over the top of the glass funnel.

If the sample concentration is greater than 750 µg/L, a 1:1 dilution of the sample is recommended for greatest accuracy. Use ultra-pure (aldehyde-free) water for the dilution. Repeat the analysis on the diluted sample and multiply the resulting concentration by two.

Alternate forms should only be used when the sample is known to contain only Mg or Ca. This method does not distinguish between the two forms.

Refer to the instrument User Manual for Pour-Thru cell and module assembly and installation.

Use dedicated plasticware for this analysis.

In bright light conditions (e.g. direct sunlight) it may be necessary to close the cell compartment with the protective cover during measurements.

Collect the following items:

Quantity

Chlorophosponazo Indicator Solution	2 mL
CDTA Reagent for Ultra Low Range Hardness	1 drop
Cylinder, graduated, 50-mL, poly	1
Dispenser, fixed-volume, 2.0-mL, Repipet Jr.	1
Flask, Erlenmeyer, PMP w/cap, 125-mL	1
Pour-Thru Cell Module	1

Note: Reorder information for consumables and replacement items is on [page 6](#).

Pour-Thru Cell

Method 8374

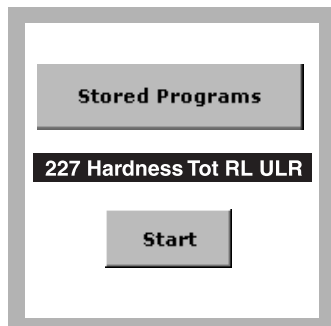

1. Select the test.

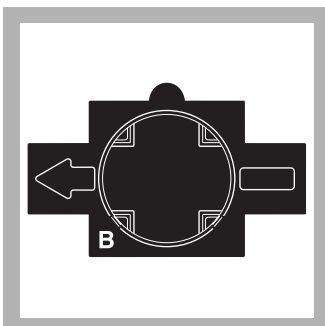

2. Insert Adapter B. Install the Pour-Thru Cell with the 1-inch round path in line with the adapter arrow. Flush the Pour-Thru cell with 50 mL of ultra-pure water.



3. Fill a clean, 125-mL plastic Erlenmeyer flask to overflowing with sample. Collect sample directly in the flask if possible.

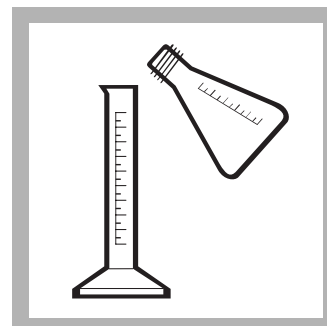

4. Rinse a clean, 50-mL plastic graduated cylinder three times with sample.

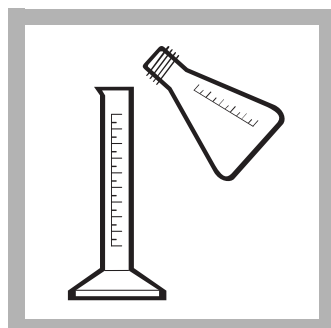

5. Fill the rinsed cylinder to the 50-mL mark with sample from the flask. Discard remaining contents of the flask.

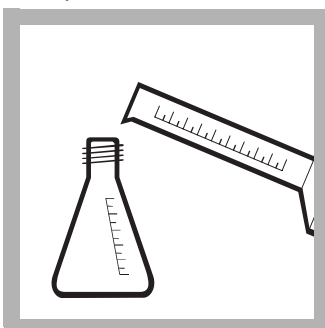

6. Pour the contents of the 50-mL cylinder back into the flask.

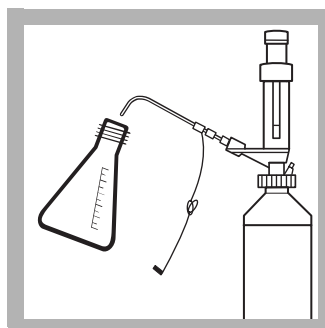

7. Add 2.0 mL of Chlorophosphonazo Reagent to the sample with the Repipet Jr. Dispenser. Swirl to mix.

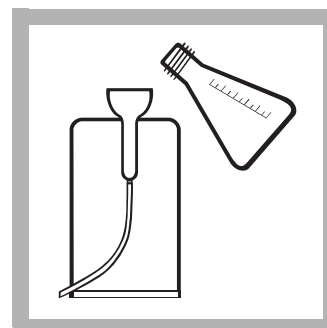

8. Pour approximately half (25 mL) of the sample into the Pour-Thru Cell. Use a clean, dry, plastic 25-mL graduated cylinder to measure the sample.

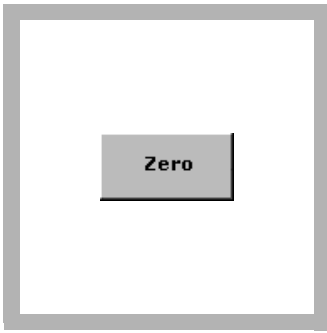

9. After the flow stops, press **ZERO**.

The display will show:

0 µg/L CaCO₃

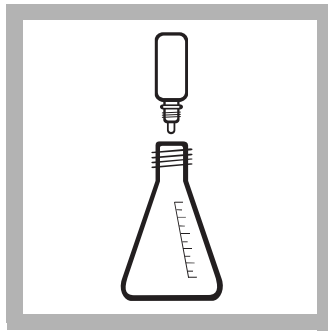

10. Add one drop of CDTA Reagent for Ultra Low Range Hardness to the remaining sample in the flask. Swirl to mix.

Complete steps 11 and 12 within one to two minutes.

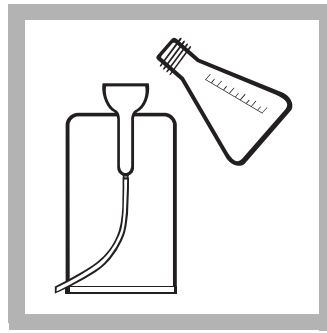

11. Pour the remaining sample into the Pour-Thru Cell.



12. After the flow stops, press **READ**. Results are in µg/L CaCO₃.

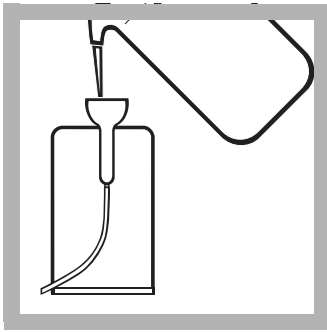

13. Using a wash bottle, rinse the Pour-Thru Cell with ultra-pure water immediately after use.

Rinse the flask with ultra-pure water. Cap when finished.

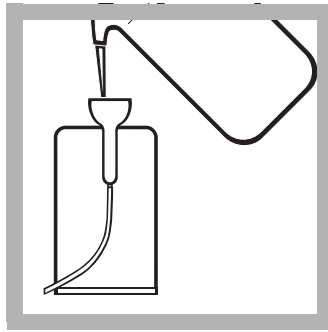

14. Flush the Pour-Thru cell with an additional 50-mL of ultra-pure water.

Interferences

Interference studies were conducted at various hardness levels between 0 and 500 µg/L as CaCO₃. Various cations and anions were evaluated at levels in the range appropriate to ultra pure water applications. An ion is said to interfere when the resulting concentration is changed by ± 10%.

Table 1 Interfering Substances and Levels

Interfering Substance	Interference Levels and Treatments
Aluminum	Negative interference above 150 µg/L
Ammonium	No interference at or below 1000 µg/L
Copper	Positive interference above 250 µg/L
Formaldehyde	No interference at or below 47,000 µg/L
Potassium	No interference at or below 1000 µg/L
Silicon	Positive interference above 1000 µg/L
Sodium	Negative interference above 79,000 µg/L

Treating Analysis Labware

Clean all containers used in this test thoroughly to remove any traces of calcium or magnesium. If possible, use plastic containers for all analysis and storage. Clean containers by normal means, then rinse with ultra-pure (aldehyde-free) water. Fill and soak for 10 minutes with a 1:25 dilution of Chlorophosphonazo Reagent in ultra-pure water. Rinse well with ultra-pure water. Keep containers tightly closed and dedicate them for ULR Hardness only. If containers are rinsed and capped after each use, only occasional soaking is necessary. Fill the Pour-Thru cell with this same mixture of chlorophosphonazo and water and let stand for several minutes. Rinse with ultra-pure water.

Avoid contamination of the Chlorophosphonazo Reagent bottle when placing the Repipet dispenser on the bottle. Rinse the inlet tubing and inside of the dispenser cap with copious amounts of ultra-pure water using a wash bottle. Place the inlet tubing into a beaker of ultra-pure water and depress the plunger 10–15 times to rinse the inside of the dispenser. (For best results, pour a small amount of reagent into the beaker of rinse water.) Remove the dispenser from the water and depress the plunger until all of the water has been expelled. Shake off any excess water on the dispenser, place the dispenser on the bottle, and tighten.

Sampling and Storage

Do not use glass containers. Collect samples in clean plastic containers, preferably with screw-type closures. Rinse containers several times with the water to be analyzed before collecting the final sample. Seal to avoid contamination during transport. Analyze as soon as possible.

Accuracy Check

Standard Additions Method (Sample Spike)

1. Leave the unspiked sample in the sample cell compartment. Press **OPTIONS>MORE**. Press **STANDARD ADDITIONS**. A summary of the standard additions procedure will appear.
2. Press **OK** to accept the default values for standard concentration, sample volume, and spike volumes. Press **EDIT** to change these values. After values are accepted, the unspiked sample reading will appear in the top row. See the user manual for more information.
3. Obtain a Calcium Chloride Standard Solution, 20-mg/L (20,000-µg/L) as CaCO₃.
4. Prepare three sample spikes. Use a TenSette® Pipet to add 0.2 mL, 0.4 mL, and 0.6 mL, of a 20-mg/L as CaCO₃ Calcium Chloride Standard to three 50-mL samples, respectively.
5. Analyze each sample spike as described in the procedure above, starting with the 0.2 mL sample spike. Accept each standard additions reading by pressing **READ**. Each addition should reflect approximately 100% recovery.
6. After completing the sequence, press **GRAPH** to view the best-fit line through the standard additions data points, accounting for the matrix interferences. Press **IDEAL LINE** to view the relationship between the sample spikes and the "Ideal Line" of 100% recovery..

Standard Solution Method

1. Using a 0.50-mg/L (500-µg/L as CaCO₃) Calcium Chloride Standard Solution, perform the procedure using the standard in place of the sample.
2. To adjust the calibration curve using the reading obtained with the standard solution, press **OPTIONS>MORE** on the current program menu. Press **STANDARD ADJUST**.
3. Press **ON**. Press **ADJUST** to accept the displayed concentration. If an alternative concentration is used, press the number in the box to enter the actual concentration, then press **OK**. Press **ADJUST**.

Summary of Method

Calcium and magnesium combine equivalently with the Chlorophosphonazo Indicator to form a colored complex which absorbs light very strongly at 669 nm. One drop of the CDTA reagent breaks up this complex, and the resultant decrease in color is proportional to the amount of calcium and magnesium (as CaCO₃) in the sample. Test results are measured at 669 nm.

Consumables and Replacement Items

Required Reagents

Description	Quantity/Test	Unit	Cat. No.
Chlorophosphonazo Indicator Solution	2 mL	500 mL	25895-49
CDTA Reagent for Ultra Low Range Hardness	1 drop	10 mL SCDB	25896-36

Required Apparatus

Description	Quantity/Test	Unit	Cat. No.
Adapter, for Multi-path and Pour-Thru cells	1	each	LZV585
Cylinder, graduated, 50-mL, poly	1	each	1081-41
Dispenser, fixed-volume, 2.0-mL, Repipet Jr.	1	each	22307-01
Flask, Erlenmeyer, PMP w/cap, 125-mL	1	each	20898-43
Pour-Thru Cell Kit	1	each	59404-00

Recommended Standards

Description	Unit	Cat. No.
Calcium Standard Solution, 20-mg/L as CaCO ₃	946 mL	21246-16
Calcium Standard Solution, 0.50-mg/L as CaCO ₃	946 mL	20580-16
Water, ultra-pure (aldehyde-free)	500 mL	25946-49

Optional Reagents and Apparatus

Description	Unit	Cat. No.
Pipet, TenSette® 0.1–1.0 mL	each	19700-01
Pipet Tips, for TenSette Pipet 19700-01	25/pkg	21856-96



FOR TECHNICAL ASSISTANCE, PRICE INFORMATION AND ORDERING:
In the U.S.A. – Call toll-free 800-227-4224
Outside the U.S.A. – Contact the HACH office or distributor serving you.
On the Worldwide Web – www.hach.com; E-mail – techhelp@hach.com

HACH COMPANY
WORLD HEADQUARTERS
Telephone: (970) 669-3050
FAX: (970) 669-2932

Method 8141

p-Dimethylaminobenzaldehyde Method¹

Reagent Solution or AccuVac[®] Ampuls

(4 to 600 µg/L)

Scope and Application: For boiler water/feedwater

¹ Adapted from ASTM Manual of Industrial Water, D1385-78, 376 (1979)



Test Preparation

Before starting the test:

Samples cannot be preserved and must be analyzed immediately

Sample temperature should be 21 ± 4 °C (70 ± 7 °F).

After adding the HydraVer[®] 2 Hydrazine Reagent, a yellow color will develop in the sample if hydrazine is present. The blank may also have a faint yellow color.

Collect the following items:

Quantity

Collect the following items:	Quantity
Solution Test:	
HydraVer 2 Reagent Solution	4 mL
Deionized Water	10 mL
Graduated Cylinder, 25-mL	1
AccuVac Test:	
HydraVer 2 Reagent AccuVac [®] Ampuls	2
Deionized Water	40 mL
Beaker, 50-mL	1

Note: Reorder information for consumables and replacement items is on page 4.

Important Note: The final samples will have a pH less than 2, which is considered corrosive (0002) by the Federal RCRA. Refer to the MSDS for disposal instructions.

Reagent Solution

Method 8141



1. Select the test.



2. Select the test.

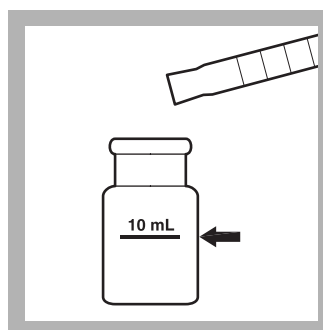

3. **Blank Preparation:**
Use a graduated cylinder to pour 10 mL of deionized water into a square sample cell.

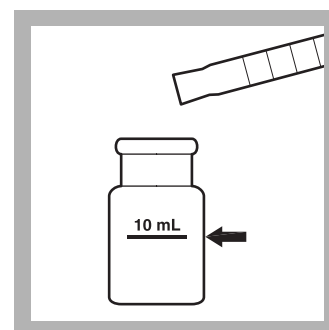

4. **Prepared Sample:**
Use a graduated cylinder to pour 10 mL of sample into a second square sample cell.

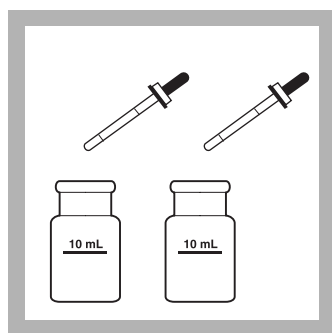

5. Add 0.5 mL of HydraVer 2 Hydrazine Reagent to each sample cell. Swirl to mix.



6. Press **TIMER>OK**.
A 12-minute reaction period will begin. Complete steps 7–8 during this period.

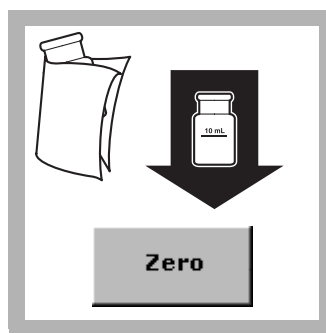

7. Insert the blank into the cell holder with the fill line facing right. Press **ZERO**.
The display will show:
0 µg/L N₂H₄

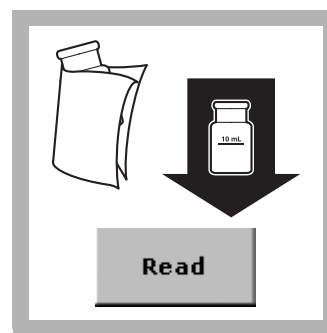

8. Insert the prepared sample into the cell holder with the fill line facing right. **Immediately** after the timer expires, press **READ**. Results are in µg/L N₂H₄.

AccuVac® Ampul

Method 8141

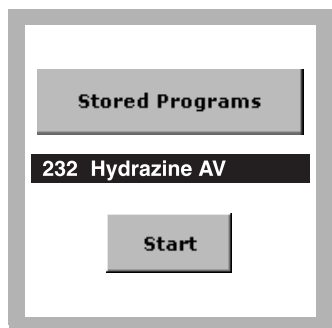

1. Select the test.

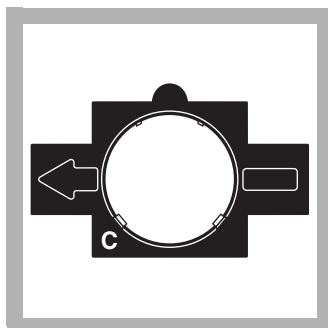

2. Insert Adapter C.

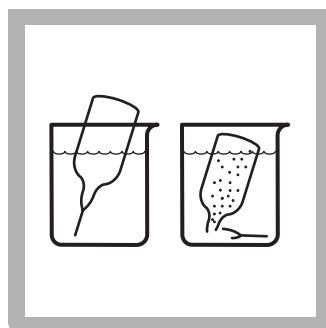

3. **Prepared Sample:** Collect at least 40 mL of sample in a 50-mL beaker. Fill a HydraVer Hydrazine AccuVac® Ampul with sample. Keep the tip immersed while the Ampul fills completely.

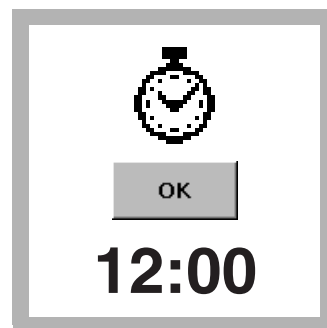

4. Immediately press **TIMER>OK**.
A 12-minute reaction period will begin. Complete steps 5–7 during this period.

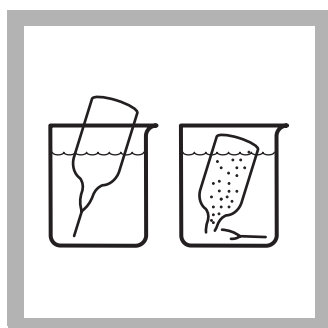

5. Blank Preparation:
Pour at least 40-mL of deionized water into a second beaker.

Fill a second Ampul with deionized water. Keep the tip immersed while the Ampul fills completely.



6. Insert the blank into the cell holder.

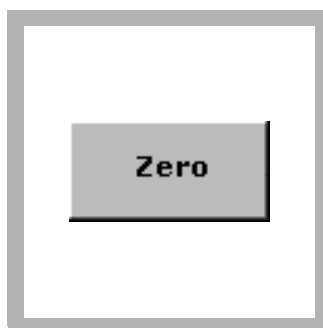

7. Press **ZERO**.
The display will show:
0 µg/L N₂H₄



8. Insert the prepared sample in the cell holder.
Immediately after the timer expires, press **READ**.
Results are in µg/L N₂H₄.

Interferences

Table 1 Interfering Substances and Levels

Interfering Substance	Interference Levels and Treatments
Ammonia	No interference up to 10 mg/L. May cause a positive interference of up to 20% at 20 mg/L.
Highly colored or turbid samples	Prepare a blank by oxidizing the hydrazine in a portion of the sample with a 1:1 mixture of deionized water and household bleach. Add one drop of the mixture to 25 mL of sample in a graduated mixing cylinder and invert to mix. Use this solution in step 2, instead of deionized water, to prepare the blank.
Morpholine	No interference up to 10 mg/L.

Sample Collection, Storage, and Preservation

Samples collected in glass or plastic bottles should be filled completely and capped tightly. Avoid excessive agitation or exposure to air. Samples must be analyzed immediately after collection and cannot be preserved for later analysis.

Accuracy Check

Standard Solutions Method

1. Prepare a 25-mg/L stock solution. Dissolve 0.1016 g of hydrazine sulfate in 1000 mL of oxygen-free deionized water. Prepare this stock solution daily.
2. Using Class A glassware, prepare a 0.25-mg/L (250-µg/L) hydrazine working solution by diluting 10.00 mL of the 25-mg/L stock solution to 1000 mL with deoxygenated deionized water. Prepare just before analysis. Perform either hydrazine procedure as described above.
3. To adjust the calibration curve using the reading obtained with the standard solution, press **OPTIONS>MORE** on the current program menu. Press **STANDARD ADJUST**.

Hydrazine (4 to 600 µg/L)

4. Press **ON**. Press **ADJUST** to accept the displayed concentration. If an alternate concentration is used, press the number in the box to enter the actual concentration, then press **OK**. Press **ADJUST**.

Summary of Method

Hydrazine in the sample reacts with the p-dimethylaminobenzaldehyde from the HydraVer 2 Reagent to form a yellow color which is proportional to the hydrazine concentration. Test results are measured at 455 nm.

Consumables and Replacement Items

Required Reagents

Description	Quantity/Test	Unit	Cat. No.
HydraVer® 2 Hydrazine Reagent	1 mL	100 mL MDB	1790-32
OR			
HydraVer 2 Hydrazine Reagent AccuVac® Ampuls	2	25/pkg	25240-25
Water, deionized	10 mL	4 L	272-56

Required Apparatus (Powder Pillows)

Description	Quantity/Test	Unit	Cat. No.
Cylinder, graduated, 25-mL.	1	each	508-40
Sample Cells, 1-inch square, 10 mL, matched pair	2	2/pkg	24954-02

Required Apparatus (AccuVac)

Description	Quantity/Test	Unit	Cat. No.
Adapter, 1-inch round, for AccuVac Ampuls	1	each	LZV584
Beaker, 50-mL	1	each	500-41H

Recommended Standards

Description	Unit	Cat. No.
Hydrazine Sulfate, ACS	100 g	742-26



FOR TECHNICAL ASSISTANCE, PRICE INFORMATION AND ORDERING:
In the U.S.A. – Call toll-free 800-227-4224
Outside the U.S.A. – Contact the HACH office or distributor serving you.
On the Worldwide Web – www.hach.com; E-mail – techhelp@hach.com

HACH COMPANY
WORLD HEADQUARTERS
Telephone: (970) 669-3050
FAX: (970) 669-2932

Method 8031

DPD Method¹

Powder Pillows or AccuVac[®] Ampuls

(0.07 to 7.00 mg/L)

Scope and Application: For testing dissolved iodine residual used as disinfectant in process water, treated water, estuary water, and seawater

¹ Adapted from Palin, A.T., *Inst. Water Eng.*, 21 (6), 537-547 (1967).



Test Preparation

Before starting the test:

Analyze samples immediately. Do not preserve for later analysis

For more accurate results, determine a reagent blank value for each new lot of reagent. Follow the procedure using deionized water instead of the sample. Subtract the reagent blank value from the final results or perform a reagent blank adjust.

If the sample temporarily turns yellow after reagent addition, dilute a fresh sample. Repeat the test. A slight loss of iodine may occur due to the dilution. Apply the appropriate dilution factor.

Collect the following items:

Quantity

Collect the following items:	Quantity
Powder Pillow Test:	
DPD Total Chlorine Reagent Powder Pillow	1
Sample cells, 1-inch square, 10-mL	2
AccuVac Test:	
DPD Total Chlorine Reagent AccuVac [®] Ampul	1
Beaker, 50-mL	1
Sample Cell, 10-mL, round	1
Stopper for 18 mm Tube	2

Note: Reorder information for consumables and replacement items is on page 4.

Powder Pillows

Method 8031



1. Press **STORED PROGRAMS**.

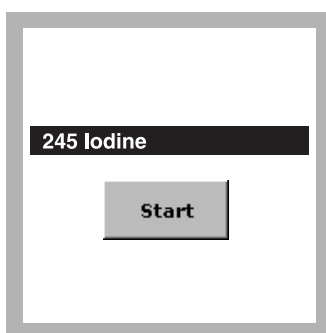

2. Select the test.

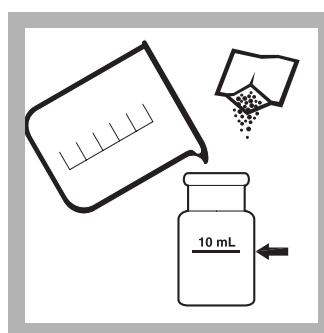

3. Prepared Sample:
Fill a square sample cell with 10 mL of sample.
Add the contents of one DPD Total Chlorine Powder Pillow to the sample cell.

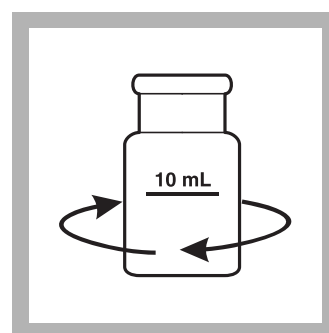

4. Swirl for about 20 seconds to mix.
A pink color will develop if iodine is present.

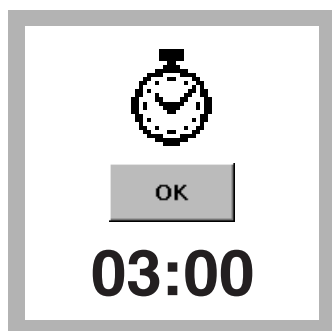

5. Press **TIMER>OK**.
A three-minute reaction period will begin.

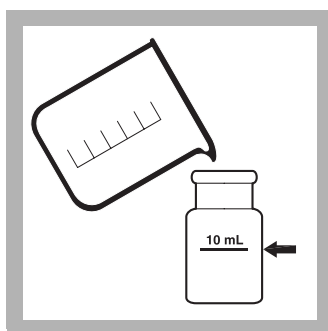

6. **Blank Preparation:**
Fill a second square sample cell with 10 mL of sample.

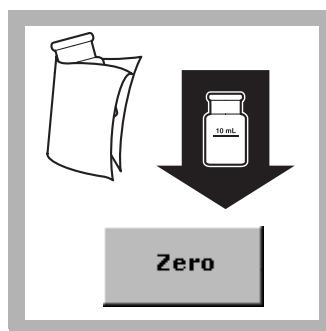

7. Wipe the blank and insert it into the cell holder with the fill line facing right. Close the cover. Press **ZERO**. The display will show:
0.00 mg/L I₂

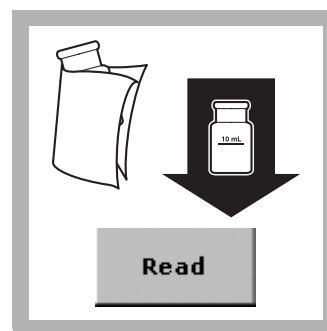

8. Within three minutes after the timer expires, wipe the prepared sample and insert it into the cell holder with the fill line facing right. Press **READ**. Results are in mg/L I₂.

AccuVac Ampul

Method 8031

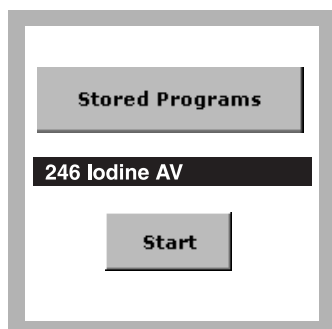

1. Select the test.

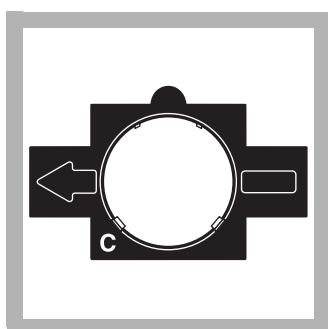

2. Insert Adapter C.

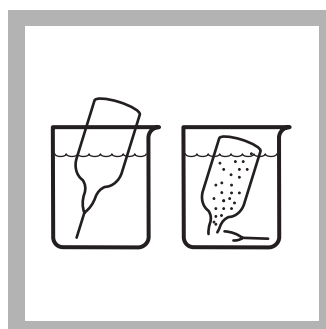

3. **Prepared Sample:**
Collect at least 40 mL of sample in a 50-mL beaker. Fill a DPD Total Chlorine Reagent AccuVac® Ampul with sample. Keep the tip immersed while the Ampul fills completely.

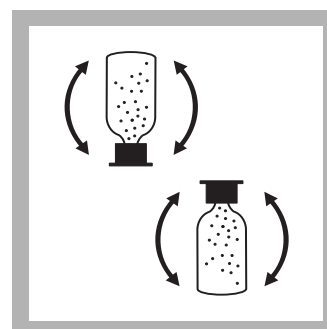

4. Quickly invert the Ampul several times to mix.
A pink color will develop if iodine is present.

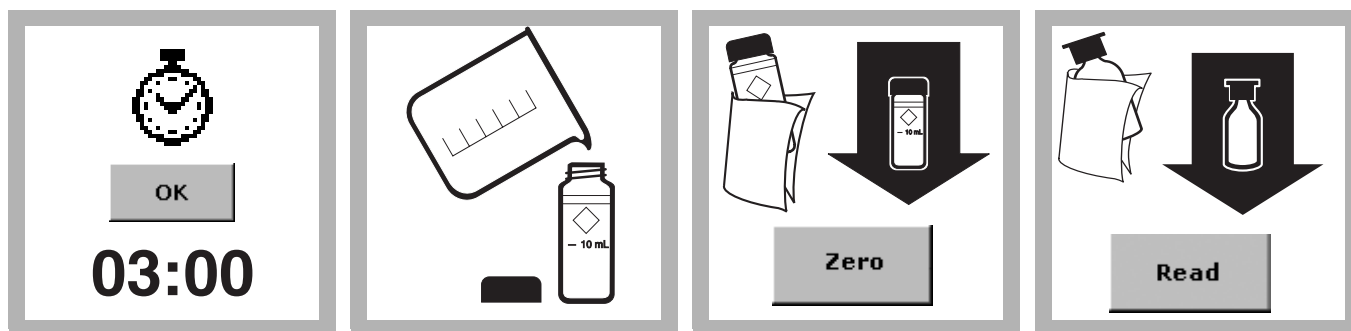
**5. Press TIMER>OK.**

A three-minute reaction period will begin. Perform steps 6–7 during the reaction period.

6. Blank Preparation:

Fill a round sample cell with 10 mL of sample.

7. Wipe the blank and insert it into the cell holder. Press ZERO. The display will show:

0.00 mg/L I₂

8. Within three minutes after the timer expires, wipe the prepared sample and insert it into the cell holder. Press READ. Results are in mg/L I₂.

Interferences

Table 1 Interfering Substances and Levels

Interfering Substance	Interference Levels and Treatments
Acidity	Greater than 150 mg/L CaCO ₃ . May not develop full color or color may fade instantly. Neutralize to pH 6–7 with 1 N Sodium Hydroxide ¹ . Determine amount to be added on separate sample aliquot, then add the same amount to the sample being tested. Correct for volume addition.
Alkalinity	Greater than 250 mg/L CaCO ₃ . May not develop full color or color may fade instantly. Neutralize to pH 6–7 with 1 N Sulfuric Acid ¹ . Determine amount to be added on separate sample aliquot, then add the same amount to the sample being tested. Correct for volume addition.
Bromine	Interferes at all levels
Chlorine and chloramines	Causes a positive interference at all levels
Chlorine Dioxide	Interferes at all levels
Chloramines, organic	May interfere
Hardness	No effect at less than 1000 mg/L as CaCO ₃
Manganese, Oxidized (Mn ⁴⁺ , Mn ⁷⁺) or Chromium, Oxidized (Cr ⁶⁺)	<ol style="list-style-type: none"> Adjust sample pH to 6–7. Add 3 drops Potassium Iodide¹ (30-g/L) to a 25-mL sample. Mix and wait 1 minute. Add 3 drops Sodium Arsenite^{1, 2} (5-g/L) and mix. Analyze 10 mL of the treated sample as described in the procedure. Subtract the result from this test from the original analysis to obtain the correct iodine concentration.
Ozone	Interferes at all levels
Peroxides	May interfere
Extreme sample pH or highly buffered samples	Adjust to pH 6–7.

¹ See [Optional Reagents and Apparatus on page 4](#).

² Samples treated with sodium arsenite for manganese or chromium interferences will be hazardous wastes as regulated by the Federal RCRA for arsenic (D004). Refer to the current MSDS for disposal information.

Sample Collection, Storage, and Preservation

Collect samples in clean, dry glass containers. If sampling from a tap, allow the water to flow at least 5 minutes to ensure a representative sample. Avoid excessive agitation and exposure to sunlight when sampling. Allow several volumes of water to overflow the container and cap the container so there is no headspace above the sample. If sampling with a sample cell, rinse the cell several times with the sample, then carefully fill to the 10-mL mark. Proceed with the analysis immediately.

Summary of Method

Iodine reacts with DPD (N, N-diethyl-p-phenylenediamine) to form a pink color, the intensity of which is proportional to the total iodine concentration. Test results are measured at 530 nm.

Consumables and Replacement Items

Required Reagents

Description	Quantity/Test	Unit	Cat. No.
DPD Total Chlorine Reagent Powder Pillows	1	100/pkg	21056-69
OR			
DPD Total Chlorine Reagent AccuVac® Ampuls	1	25/pkg	25030-25

Required Apparatus (Powder Pillows)

Description	Quantity/Test	Unit	Cat. No.
Sample Cells, 1-inch square, 10 mL, matched pair	2	2/pkg	24954-02
Stopper for 18 mm tube	—	6/pkg	1731-06

Required Apparatus (AccuVac)

Description	Quantity/Test	Unit	Cat. No.
Adapter, 1-inch round, for AccuVac Ampuls	1	each	LZV584
Beaker, 50-mL	1	each	500-41H
Sample Cell, 10-mL, with cap	1	each	21228-00

Optional Reagents and Apparatus

Description	Cat. No.
Potassium Iodide, 30 g/L, 100 mL	343-32
Sodium Arsenite, 5-g/L, 100 mL	1047-32
Sodium Hydroxide, 1 N, 100 mL	1045-32
Stopper for 18 mm tube, 25/pkg	1731-25
Sulfuric Acid, 1 N, 100 mL	1270-32



FOR TECHNICAL ASSISTANCE, PRICE INFORMATION AND ORDERING:
In the U.S.A. – Call toll-free 800-227-4224
Outside the U.S.A. – Contact the HACH office or distributor serving you.
On the Worldwide Web – www.hach.com; E-mail – techhelp@hach.com

HACH COMPANY
WORLD HEADQUARTERS
Telephone: (970) 669-3050
FAX: (970) 669-2932

Method 8147

FerroZine® Method¹

FerroZine® Reagent Solution Pillows

(0.009 to 1.400 mg/L)

Scope and Application: For water and wastewater

¹ Adapted from Stookey, L.L., *Anal. Chem.*, 42(7), 779 (1970)



Test Preparation

Before starting the test:

Digestion is required for total iron determination.

Rinse glassware with a 1:1 hydrochloric acid solution. Rinse again with deionized water. These two steps will remove iron deposits that can cause slightly high results.

For more accurate results, determine a reagent blank value for each new lot of reagent. Follow the procedure using deionized water instead of the sample. Subtract the reagent blank value from the final results or perform a reagent blank adjust.

Instead of solution pillows, 0.5 mL of FerroZine® Iron Reagent Solution can be used.

If the sample contains rust, see [Interferences on page 3](#).

Use clean clippers, free of rust, and wipe with a dry towel. Do not allow clippers to contact contents of the pillow.

FerroZine Iron Reagent may crystallize or precipitate when exposed to cold temperatures during shipment. Reagent quality is not affected. Place the reagent in warm water to redissolve.

Collect the following items:

Quantity

FerroZine Iron Reagent Solution Pillows	1
OR	
FerroZine Iron Reagent Solution	0.5 mL
Cylinder, 25-mL graduated mixing, with stopper	1
Clippers for solution pillows	1
Sample Cells, 1-inch square, 10-mL	2

Note: Reorder information for consumables and replacement items is on [page 5](#).

Solution Pillows

Method 8147



1. Press **STORED PROGRAMS**.

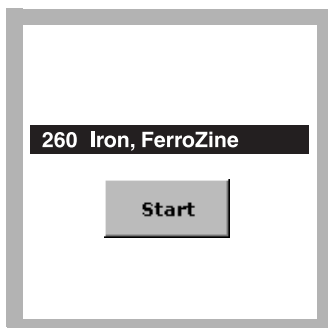

2. Select the test.

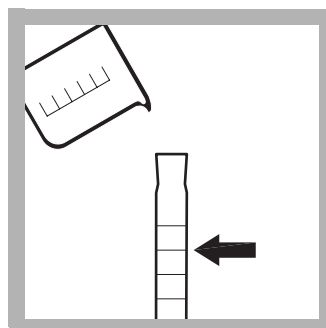

3. Fill a clean 25-mL graduated mixing cylinder to the 25-mL mark with sample.

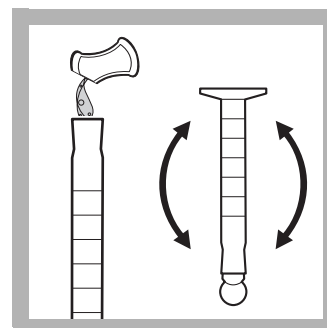

4. **Prepared Sample:** Add the contents of one FerroZine® Iron Reagent Solution Pillow to the mixing cylinder. Stopper and invert to mix.

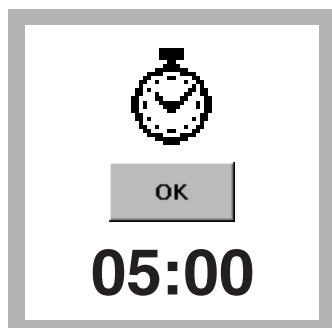

5. Press **TIMER>OK**.
A five-minute reaction period will begin. A purple color will develop if iron is present.

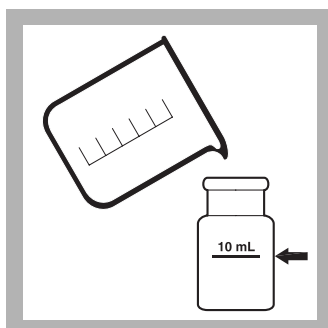

6. **Blank Preparation:** Fill a square sample cell with 10 mL of sample.

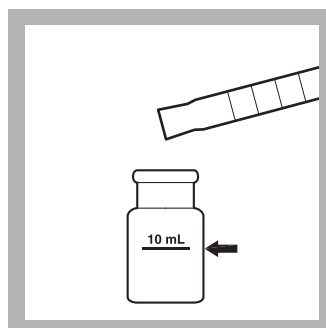

7. When the timer expires, pour 10 mL of the prepared sample into a second clean square sample cell.



8. Insert the blank into the cell holder with the fill line facing right.

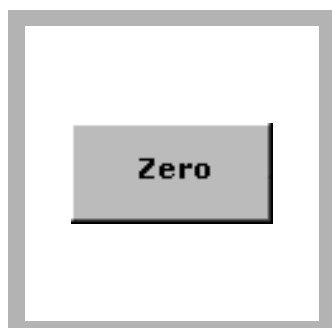

9. Press **ZERO**.
The display will show:
0.000 mg/L Fe



10. Insert the prepared sample into the cell holder with the fill line facing right.

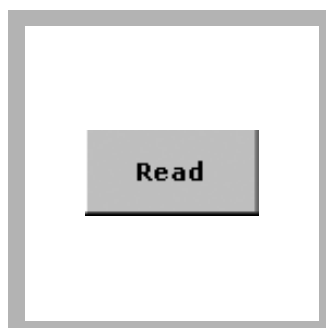

11. Press **READ**.
Results are in mg/L Fe.

Interferences

Table 1 Interfering Substances and Levels

Interfering Substance	Interference Levels and Treatments
Strong chelants (EDTA)	Interfere at all levels. Use the FerroVer® or TPTZ methods for these samples. Use the TPTZ method for low iron concentrations.
Cobalt	May give slightly high results
Copper	May give slightly high results
Hydroxides	Boil the sample, with the FerroZine® Iron Reagent added to it from step 4, for 1 minute in a boiling water bath. Cool to 24 °C (75 °F) before proceeding with step 5. Return the sample volume to 25 mL with deionized water.
Magnetite (black iron oxide) or Ferrites	<ol style="list-style-type: none"> 1. Fill a 25-mL graduated cylinder with 25 mL of sample. 2. Transfer this sample into a 125-mL Erlenmeyer flask. 3. Add the contents of one FerroZine® Iron Reagent Solution Pillow and swirl to mix. 4. Place the flask on a hot plate or over a flame and bring to a boil. 5. Continue boiling gently for 20 to 30 minutes. <p>Note: Do not allow to boil dry.</p> <p>Note: A purple color will develop if iron is present.</p> <ol style="list-style-type: none"> 6. Return the boiled sample to the 25-mL graduated cylinder. Rinse the Erlenmeyer flask with small amounts of deionized water and empty into the graduated cylinder. 7. Return the sample volume to the 25-mL mark with deionized water. 8. Pour this solution into a sample cell and swirl to mix. <p>Proceed with steps 5–10.</p>
Rust	Boil the sample, with the FerroZine Iron Reagent added to it from step 4, for 1 minute in a boiling water bath. Cool to 24 °C (75 °F) before proceeding with step 5. Return the sample volume to 25 mL with deionized water.

Sample Collection, Storage, and Preservation

Collect samples in acid-washed glass or plastic bottles. To preserve samples, adjust the sample pH to 2 or less with concentrated Nitric Acid, ACS* (about 2 mL per liter). Samples preserved in this manner can be stored up to six months at room temperature. If only reporting dissolved iron, filter the sample immediately after collection and before adding nitric acid.

Before testing, adjust the sample pH to 3–5 with Ammonium Hydroxide, ACS*. Do not exceed pH 5, or iron may precipitate. Correct test results for volume additions.

* See [Optional Reagents and Apparatus on page 5](#).

Accuracy Check

Standard Additions Method (Sample Spike)

1. After reading test results, leave the sample cell (unspiked sample) in the instrument.
2. Press **OPTIONS>MORE**. Press **STANDARD ADDITIONS**. A summary of the standard additions procedure will appear.
3. Press **OK** to accept the default values for standard concentration, sample volume, and spike volumes. Press **EDIT** to change these values. After values are accepted, the unspiked sample reading will appear in the top row. See the user manual for more information.
4. Snap the neck off an Iron Voluette® Ampule Standard, 10-mg/L Fe.
5. Prepare a 0.1 mL sample spike by adding 0.1 mL of standard to the unspiked sample. Press the timer icon. After the timer expires, read the result.
6. Prepare a 0.2 mL sample spike by adding 0.1 mL of standard to the 0.1 mL sample spike. Press the timer icon. After the timer expires, read the result.
7. Prepare a 0.3 mL sample spike by adding 0.1 mL of standard to the 0.2 mL sample spike. Press the timer icon. After the timer expires, read the result. Each addition should reflect approximately 100% recovery.
8. After completing the sequence, press **GRAPH** to view the best-fit line through the standard additions data points, accounting for matrix interferences. Press **IDEAL LINE** to view relationships between the sample spikes and the “Ideal Line” of 100% recovery.

Standard Solution Method

1. Using Class A glassware, prepare a 1.0-mg/L Fe standard solution by pipetting 5.00 mL of Iron Standard Solution, 100-mg/L, into a 500-mL volumetric flask. Dilute to the mark with deionized water. Prepare this solution daily. Perform the iron procedure as described above.
2. To adjust the calibration curve using the reading obtained with the standard solution, press **OPTIONS>MORE** on the current program menu. Press **STANDARD ADJUST**.
3. Press **ON**. Press **ADJUST** to accept the displayed concentration. If an alternate concentration is used, press the number in the box to enter the actual concentration, then press **OK**. Press **ADJUST**.

Summary of Method

The FerroZine® Iron Reagent forms a purple-colored complex with trace amounts of iron in samples that are buffered to a pH of 3.5. This method is applicable for determining trace levels of iron in chemical reagents and glycols and with digestion can be used to analyze samples containing magnetite (black iron oxide) or ferrites. Test results are measured at 562 nm.

Consumables and Replacement Items

Required Reagents

Description	Quantity/Test	Unit	Cat. No.
FerroZine® Iron Reagent Solution, or	0.5 mL	500 mL	2301-49
FerroZine® Iron Reagent Solution Pillows	1	50/pkg	2301-66

Required Apparatus

Description	Quantity/Test	Unit	Cat. No.
Clippers for solution pillows	1	each	968-00
Cylinder, graduated mixing, 25-mL with stopper	1	each	20886-40
Sample Cells, 1-inch square, 10-mL, matched pair	2	2/pkg	24954-02

Recommended Standards and Apparatus

Description	Unit	Cat. No.
Iron Standard Solution, 100-mg/L Fe	100 mL	14175-42
Iron Standard Solution, 10-mL Voluette® ampule, 10-mg/L Fe	16/pkg	14253-10
Metals Drinking Water Standard, LR for Cu, Fe, Mn	500 mL	28337-49
Flask, volumetric, Class A, 500 mL	each	14574-49
Pipet, TenSette, 0.1–1.0 mL	each	19700-01
Pipet Tips, for TenSette Pipet 19700-01	50/pkg	21856-96
Pipet Tips, for TenSette Pipet 19700-01	1000/pkg	21856-28
Pipet, volumetric, Class A, 5.00 mL	each	14515-37
Pipet Filler, safety bulb	each	14651-00

Optional Reagents and Apparatus

Description	Cat. No.
Ammonium Hydroxide, ACS, 58%	106-49
Hydrochloric Acid, 1:1, 6N	884-49
Nitric Acid, ACS, concentrated	152-49



FOR TECHNICAL ASSISTANCE, PRICE INFORMATION AND ORDERING:

In the U.S.A. – Call toll-free 800-227-4224

Outside the U.S.A. – Contact the HACH office or distributor serving you.

On the Worldwide Web – www.hach.com; E-mail – techhelp@hach.com

HACH COMPANY
WORLD HEADQUARTERS
Telephone: (970) 669-3050
FAX: (970) 669-2932

Iron, Ferrous

Method 8146

1, 10 Phenanthroline Method¹

Powder Pillows or AccuVac[®] Ampuls

(0.02 to 3.00 mg/L)

Scope and Application: For water, wastewater, and seawater

¹ Adapted from *Standard Methods for the Examination of Water and Wastewater*, 15th ed. 201 (1980)



Test Preparation

Before starting the test:

For more accurate results, determine a reagent blank value for each new lot of reagent. Follow the procedure using deionized water instead of the sample. Subtract the reagent blank value from the final results or perform a reagent blank adjust.

Analyze samples as soon as possible to prevent air oxidation of ferrous iron to ferric iron, which is not determined.

If ferrous iron is present, an orange color will form after adding the reagent.

Collect the following items:

Quantity

Collect the following items:	Quantity
Powder Pillow Test:	
Ferrous Iron Reagent Powder Pillows	1
Sample Cells, 1-inch square, 10-mL	2
AccuVac Test:	
Ferrous Iron Reagent AccuVac [®] Ampuls	1
Beaker, 50-mL (AccuVac test)	1
Sample Cell, 10-mL	1

Note: Reorder information for consumables and replacement items is on page 5.

Powder Pillows

Method 8146



1. Press **STORED PROGRAMS**.

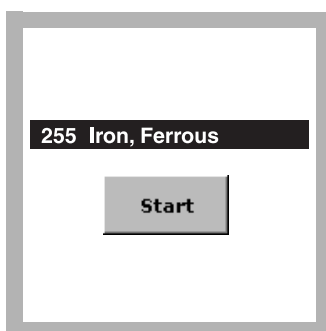

2. Select the test.

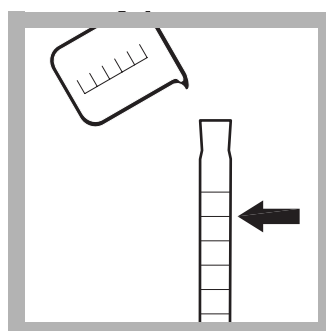

3. Fill a clean, mixed graduated cylinder with 25 mL of sample.

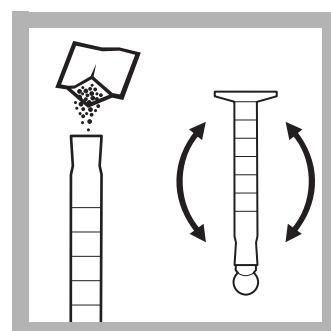

4. **Prepared Sample:** Add the contents of one Ferrous Iron Reagent Powder Pillow to the cylinder. Stopper and invert to mix.

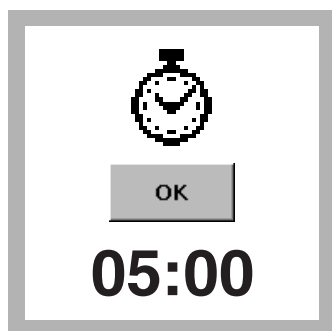

5. Press TIMER>OK.
A three-minute reaction period will begin.

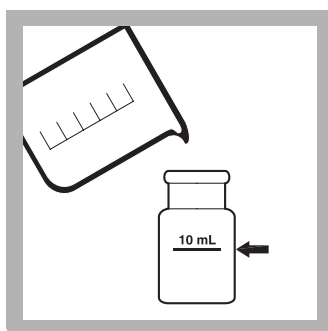

6. Blank Preparation:
Fill a square cell with 10 mL of sample.

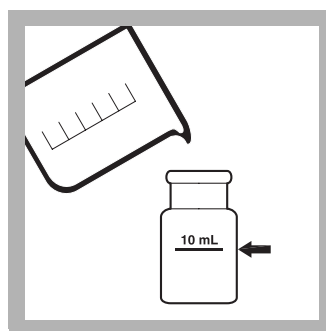

7. Fill a second square sample cell with the prepared sample from the mixing cylinder.

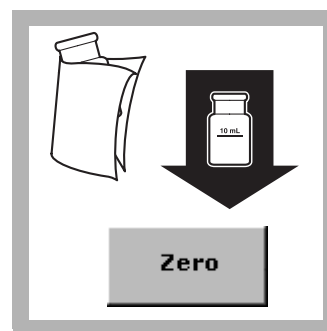

8. When the timer expires, insert the blank into the cell holder with the fill line facing right.

Press **ZERO**. The display will show:

0.00 mg/L Fe²⁺



9. Insert the prepared sample into the cell holder with the fill line facing right.

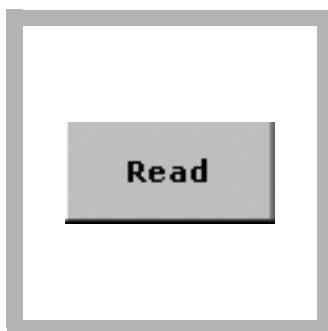

10. Press READ.
Results are in mg/L Fe²⁺.

AccuVac Ampul

Method 8146

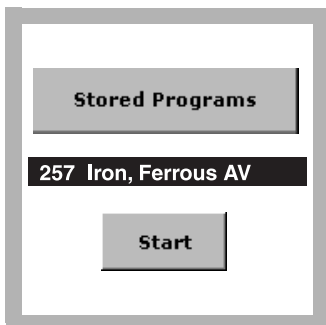

1. Select the test.

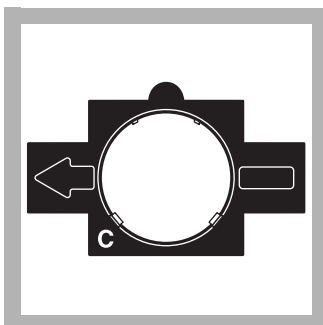

2. Insert Adapter C.

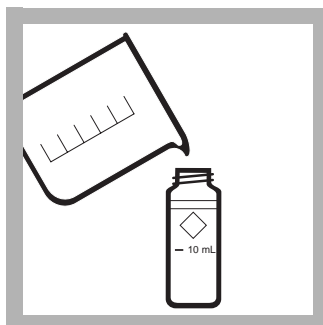

3. **Blank Preparation:**
Fill a round sample cell with 10 mL of sample.

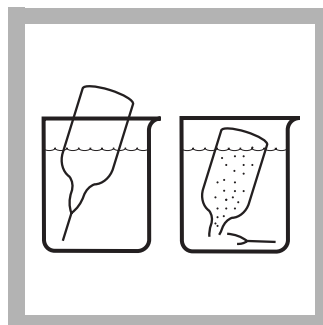

4. **Prepared Sample:**
Collect at least 40 mL of sample in a 50-mL beaker. Fill a Ferrous Iron AccuVac® Ampul with sample. Keep the tip immersed while the Ampul fills completely.

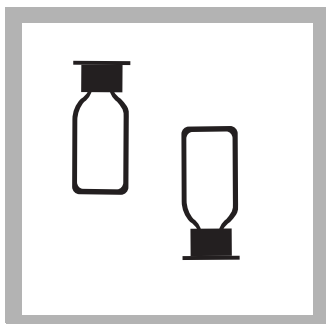

5. Quickly invert the Ampul several times to mix.

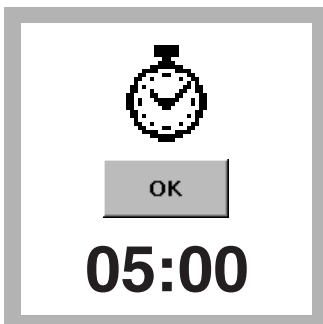

6. Press **TIMER>OK**.
A three-minute reaction period will begin.

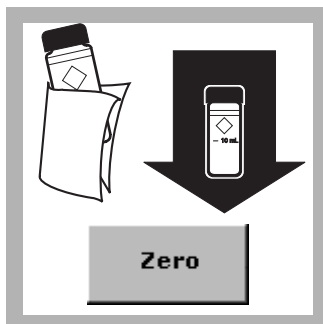

7. When the timer expires, insert the blank into the cell holder.
Press **ZERO**.
The display will show:
0.00 mg/L Fe²⁺



8. Insert the AccuVac Ampul into the cell holder.
Press **READ**. Results are in mg/L Fe²⁺.

Sample Collection, Storage, and Preservation

Collect samples in plastic or glass bottles. Analyze samples as soon as possible after collection.

Accuracy Check

Standard Solution Method

1. Prepare a ferrous iron stock solution (100-mg/L Fe^{2+}) by dissolving 0.7022 grams of Ferrous Ammonium Sulfate, hexahydrate, in deionized water. Dilute to one liter in a Class A volumetric flask. In a 100-mL Class A volumetric flask, dilute 2.00 mL of this solution to 100 mL with deionized water to make a 2.0-mg/L standard solution. Prepare this solution immediately before use. Perform the iron procedure as described above.
2. To adjust the calibration curve using the reading obtained with the standard solution, press **OPTIONS>MORE** on the current program menu. Press **STANDARD ADJUST**.
3. Press **ON**. Press **ADJUST** to accept the displayed concentration. If an alternate concentration is used, press the number in the box to enter the actual concentration, then press **OK**. Press **ADJUST**.

Summary of Method

The 1,10 phenanthroline indicator in the Ferrous Iron Reagent reacts with ferrous iron in the sample to form an orange color in proportion to the iron concentration. Ferric iron does not react. The ferric iron (Fe^{3+}) concentration can be determined by subtracting the ferrous iron concentration from the results of a total iron test. Test results are measured at 510 nm.

Consumables and Replacement Items

Required Reagents

Description	Quantity/Test	Unit	Cat. No.
Ferrous Iron Reagent Powder Pillows	1	100/pkg	1037-69
OR			
Ferrous Iron Reagent AccuVac® Ampuls	1	25/pkg	25140-25

Required Apparatus (Powder Pillows)

Description	Quantity/Test	Unit	Cat. No.
Sample Cells, 1-inch square, 10 mL, matched pair	2	2/pkg	24954-02

Required Apparatus (AccuVac)

Description	Quantity/Test	Unit	Cat. No.
Adapter, 1-inch round, for AccuVac Ampuls	1	each	LZV584
Beaker, 50-mL	1	each	500-41H
Sample Cell, 10-mL, with cap	1	each	21228-00

Recommended Standards

Description	Unit	Cat. No.
Balance, analytical	each	28014-01
Ferrous Ammonium Sulfate, hexahydrate, ACS	113 g	11256-14
Flask, volumetric, 1000 mL	each	14574-53
Pipet Bulb	each	14651-00
Pipet, volumetric, 2.00 mL	each	14515-35
Water, deionized	4 L	272-56



FOR TECHNICAL ASSISTANCE, PRICE INFORMATION AND ORDERING:

In the U.S.A. – Call toll-free 800-227-4224
Outside the U.S.A. – Contact the HACH office or distributor serving you.
On the Worldwide Web – www.hach.com; E-mail – techhelp@hach.com

HACH COMPANY
WORLD HEADQUARTERS
Telephone: (970) 669-3050
FAX: (970) 669-2932

Method 8147

FerroZine® Rapid Liquid Method*

Pour-Thru Cell

(0.009 to 1.400 mg/L Fe)

Scope and Application: For boiler, cooling, and natural waters¹

¹ Adapted from Stookey, L.L., *Anal.Chem.*, 42 (7) 779 1970.



Test Preparation

Before starting the test:

If sample contains rust, see [Interferences on page 3](#).

Digestion is required for total iron determination.

For more accurate results, determine a reagent blank value for each new lot of reagent. Follow the procedure using deionized water in place of the sample. Subtract the reagent blank value from the final results or perform a reagent blank adjust.

If iron is present, a purple color will form after adding the reagent

Rinse glassware with a 1:1 HCl¹ solution. Rinse again with deionized water. This will remove residual iron that may interfere

Prepare the Pour-Thru cell by preparing a solution of 1 mL FerroZine Reagent per 50 mL of deionized water. Pour this into the cell and allow to stand for approximately 5 minutes to react with any trace iron in the cell and cell tubing. Flush with iron free water.

FerroZine Iron Reagent may crystallize or precipitate when exposed to cold temperatures during shipment; reagent quality is not affected. Place the reagent in warm water to dissolve.

Collect the following items:

Quantity

FerroZine® Iron Reagent Solution	1.0 mL
Water, deionized	varies
Cylinder, graduated, 50-mL poly	1
Dispenser, fixed volume, 1.0-mL, Repipet Jr., with bottle	1
Flask, Erlenmeyer, PMP w/cap, 125-mL	2
Pour-Thru Cell Module	1

Note: Reorder information for consumables and replacement items is on page 6.

¹ See [Optional Reagents and Apparatus on page 6](#).

Pour-Thru Cell

Method 8147



1. Select the test.

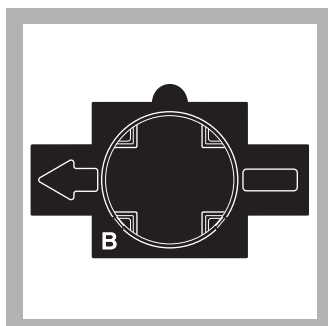

2. Insert Adapter B. Install the Pour-Thru Cell with the 1-inch pathlength in line with the adapter arrow.

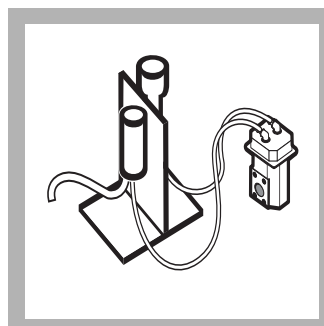

3. Flush the Pour-Thru Cell with 50 mL of deionized water.

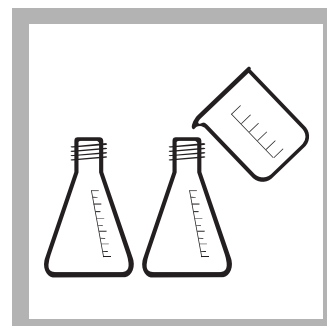

4. Rinse two clean 125-mL Erlenmeyer flasks with the sample three times.

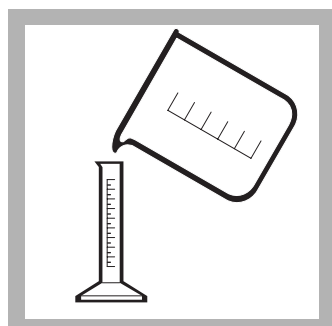

5. Rinse a clean 50-mL plastic graduated cylinder three times with the sample.

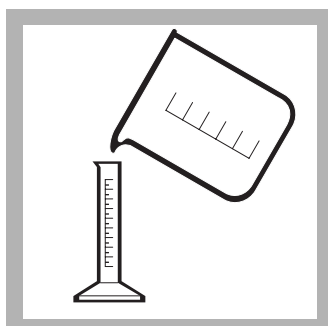

6. Fill the rinsed cylinder to the 50-mL mark with sample.

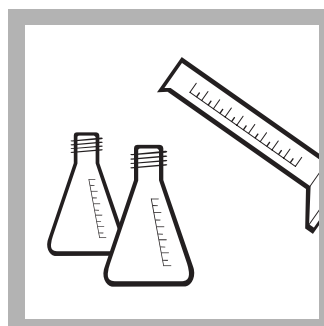

7. **Prepared Sample:** Pour the contents of the 50-mL cylinder into one of the flasks.

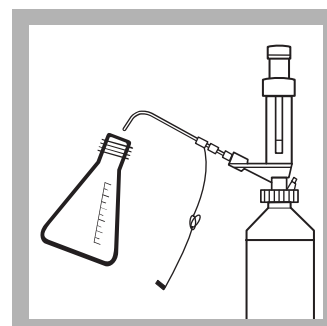

8. Add 1.0 mL of FerroZine Iron Reagent Solution to one of the flasks using the Repipet Dispenser. Swirl to mix.

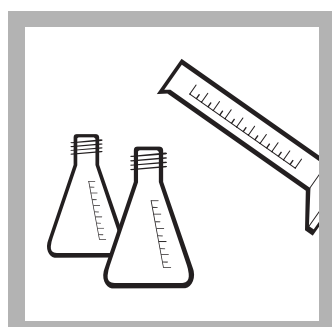

9. **Blank Preparation:** Measure a second 50 mL portion of sample into the graduated cylinder and pour the contents into the second flask.

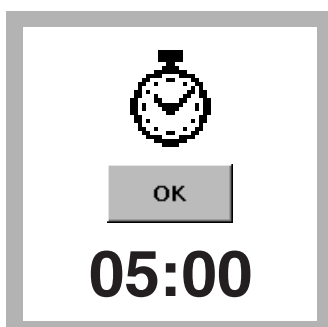

10. Press **TIMER>OK**. A five-minute reaction period will begin.

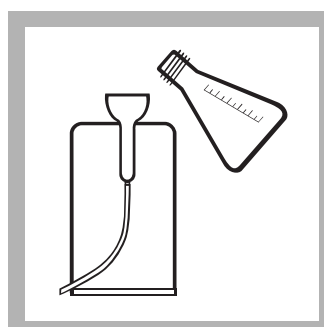

11. When the timer expires, the display will show: mg/L Fe
Pour the contents of the flask containing the blank into the Pour-Thru Cell.

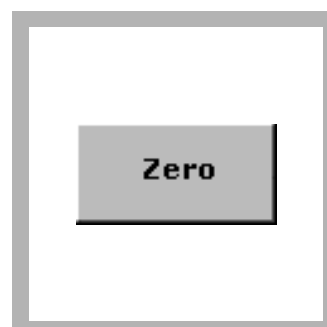

12. When the flow stops, press **ZERO**.
The display will show:
0.000 mg/L Fe

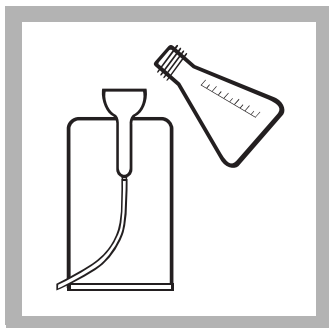

13. Pour the contents of the flask containing the prepared sample into the Pour-Thru Cell.

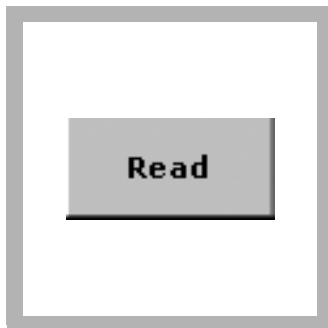

14. When the flow stops, press **READ**.
Results are in mg/L Fe.

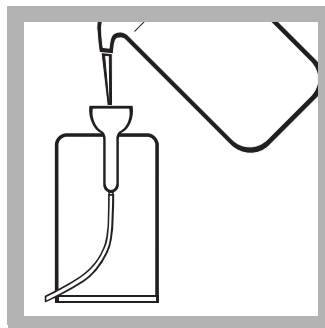

15. Flush the Pour-Thru Cell with at least 50 mL of deionized water immediately after use.

Interferences

Table 1 Interfering Substances and Levels

Interfering Substance	Interference Levels
Strong Chelants (EDTA)	Interfere at all levels. Use the FerroVer [®] or TPTZ methods for these samples. Use the TPTZ method for low iron concentrations.
Cobalt	May give slightly high results
Copper	May give slightly high results
Hydroxides	Boil the sample, with the FerroZine [®] Iron Reagent added to it from step 8, for 1 minute in a boiling water bath. Cool to 24 °C (75 °F) before proceeding with step 8. Return the sample volume to 50 mL with deionized water.
Magnetite (black iron oxide) or Ferrites	<ol style="list-style-type: none"> 1. Fill a 50-mL graduated cylinder with 50 mL of sample. 2. Transfer the sample into a clean glass 125-mL Erlenmeyer flask. 3. Add 1.0-mL of FerroZine Iron Reagent Solution¹ and swirl to mix. 4. Place the flask on a hot plate or over a flame and bring to a boil. 5. Continue boiling gently for 20 to 30 minutes. <p>Note: Do not allow to boil dry.</p> <ol style="list-style-type: none"> 6. Return the boiled sample to the graduated cylinder. Rinse the Erlenmeyer flask with small amounts of deionized water and empty into the graduated cylinder. <p>Note: A purple color will develop if iron is present.</p> <ol style="list-style-type: none"> 7. Return the sample volume to the 50-mL mark with deionized water. 8. Pour the solution into a 125-mL Erlenmeyer flask and swirl to mix. 9. Proceed with steps 8–13.
Rust	Boil the sample, with the FerroZine [®] Iron Reagent added to it from step 8, for 1 minute in a boiling water bath. Cool to 24 °C (75 °F) before proceeding with step 8. Return the sample volume to 50 mL with deionized water.

¹ See [Optional Reagents and Apparatus on page 6](#).

Sample Collection, Storage, and Preservation

Collect samples in acid-washed glass or plastic bottles. To preserve samples, adjust the sample pH to 2 or less with concentrated Nitric Acid, ACS* (about 2 mL per liter). Samples preserved in this manner can be stored up to six months at room temperature. If only reporting dissolved iron, filter the sample immediately after collection and before adding nitric acid.

Before testing, adjust the sample pH to 3–5 with Ammonium Hydroxide, ACS*. Do not exceed pH 5, or iron may precipitate. Correct test results for volume additions.

Labware

All containers used in this test must be cleaned thoroughly to remove any traces of iron. Rinse labware and the Pour-Thru Cell with a 1:1 HCl solution* or with a 1:50 dilution of FerroZine® Reagent. Rinse several times with deionized water.

Keep flasks tightly closed when not in use. Dedicate these containers for iron analysis only. If containers are rinsed and capped after each use, only occasional treatment with HCl or FerroZine® is necessary.

Cleaning the Pour-Thru Cell

The Pour-Thru Cell may accumulate a buildup of colored products, especially if the reacted solutions are allowed to stand in the cell for long periods after measurement. Remove the color by rinsing with a 1:5 dilution of Ammonium Hydroxide*, followed by several rinses with deionized water. Cover the Pour-Thru Cell when it is not in use.

Accuracy Check

Standard Additions Method (Sample Spike)

1. After reading the test results, leave the sample cell (unspiked sample) in the instrument.
2. Press **OPTIONS>MORE**. Press **STANDARD ADDITIONS**. A summary of the standard additions procedure will appear.
3. Press **OK** to accept the default values for standard concentration, sample volume, and spike volumes. Press **EDIT** to change these values. After values are accepted, the unspiked sample reading will appear in the top row. See the user manual for more information.
4. Snap the neck off an Iron Voluette® Ampule Standard, 25-mg/L Fe.
5. Use the TenSette® Pipet to add 0.2, 0.4, and 0.6 mL of standard to three 50-mL samples, respectively.
6. Analyze each sample as described above. Each addition should reflect approximately 100% recovery.
7. After completing the sequence, press **GRAPH** to view the best-fit line through the standard additions data points, accounting for matrix interferences. Press **IDEAL LINE** to view relationships between the sample spikes and the “Ideal Line” of 100% recovery.

* See [Optional Reagents and Apparatus on page 6](#).

Standard Solutions Method

To check the accuracy, use a 1.0 mg/L Iron Standard Solution or prepare a 1.0 mg/L iron working solution as follows:

1. Pipet 5.00 mL of iron standard solution, 100-mg/L Fe, into a 500-mL volumetric flask.
2. Dilute to volume with deionized water. Prepare this solution daily. Analyze the working solution according to the above procedure.
3. To adjust the calibration curve using the reading obtained with the standard solution, press **OPTIONS>MORE** on the current program menu. Press **STANDARD ADJUST**.
4. Press **ON**. Press **ADJUST** to accept the displayed concentration. If an alternate concentration is used, press the number in the box to enter the actual concentration, then press **OK**. Press **ADJUST**.

Summary of Method

The FerroZine® Iron Reagent forms a purple colored complex with trace amounts of iron in samples that are buffered to a pH of 3.5. This method is applicable for determining trace levels of iron in chemical reagents and glycols, and with digestion can be used to analyze samples containing magnetite (black iron oxide) or ferrites. The test results are measured at 562 nm.

Iron (0.009 to 1.400 mg/L Fe)

Consumables and Replacement Items

Required Reagents

Description	Quantity/Test	Unit	Cat. No.
FerroZine® Iron Reagent Solution	1 mL	500 mL	2301-49
Water, deionized	varies	4 L	272-56

Required Apparatus

Description	Quantity/Test	Unit	Cat. No.
Adapter for Multi-path and Pour-Thru cells	1	each	LZV585
Cylinder, graduated, 50-mL, poly	1	each	1081-41
Dispenser, fixed volume, 1.0-mL, Repipet Jr., with bottle	1	each	21113-02
Flask, Erlenmeyer, PMP w/cap, 125-mL	2	each	20898-43
Pour-Thru Cell Kit	1	each	59404-00

Recommended Standards and Apparatus

Description	Unit	Cat. No.
Flask, volumetric, Class A, 500 mL	each	14574-49
Iron Standard Solution, 100-mg/L Fe	100 mL	14175-42
Iron Standard Solution, Voluette® ampule, 25-mg/L Fe, 10-mL	16/pkg	14253-10
Iron Standard Solution, 1 mg/L Fe	500 mL	139-49
Metals Drinking Water Standard, LR for Cu, Fe, Mn	500 mL	28337-49
Pipet, TenSette 0.1–1.0 mL	each	19700-01
Pipet Tips, for TenSette Pipet 19700-01	50/pkg	21856-96
Pipet Tips, for TenSette Pipet 19700-01	1000/pkg	21856-28
Pipet, volumetric, Class A, 5.00 mL	each	14515-37
Pipet Filler, safety bulb	each	14651-00

Optional Reagents and Apparatus

Description	Cat. No.
Ammonium Hydroxide, ACS, 58%	106-49
Hydrochloric Acid, 1:1, 6N	884-49
Nitric Acid ACS, concentrated	152-49



FOR TECHNICAL ASSISTANCE, PRICE INFORMATION AND ORDERING:
In the U.S.A. – Call toll-free 800-227-4224
Outside the U.S.A. – Contact the HACH office or distributor serving you.
On the Worldwide Web – www.hach.com; E-mail – techhelp@hach.com

HACH COMPANY
WORLD HEADQUARTERS
Telephone: (970) 669-3050
FAX: (970) 669-2932

Iron, Total

Method 8112

TPTZ Method¹

Powder Pillows or AccuVac[®] Ampuls

(0.012 to 1.800 mg/L)

Scope and Application: For water, wastewater, and seawater

¹ Adapted from G. Frederic Smith Chemical Co., *The Iron Reagents*, 3rd ed. (1980)



Test Preparation

Before starting the test:

Digestion is required for determining total iron.

For more accurate results, determine a reagent blank value for each new lot of reagent. Follow the procedure using deionized water instead of the sample. Subtract the reagent blank value from the final results or perform a reagent blank adjust.

Rinse all glassware with a 1:1 Hydrochloric Acid Solution¹. Rinse again with deionized water. This process will remove iron deposits that can cause slightly high results.

After adding reagent, a blue color will develop if iron is present.

Adjust the pH of stored samples to 3–4. Do not exceed pH 5 or iron may precipitate.

Collect the following items:

Quantity

	Quantity
Powder Pillow Test:	
TPTZ Iron Reagent Powder Pillow	2
Sample Cells, 1-inch square, 10-mL	2
AccuVac Test:	
TPTZ Low Range Iron Reagent AccuVac [®]	1
Beaker, 50-mL	1
Sample Cell, 10-mL	1

Note: Reorder information for consumables and replacement items is on page 5.

¹ See [Optional Reagents and Apparatus](#) on page 5.

TPTZ Powder Pillows

Method 8112



1. Press **STORED PROGRAMS**.

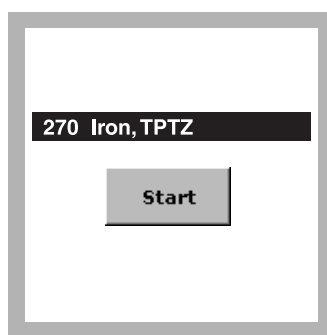

2. Select the test.

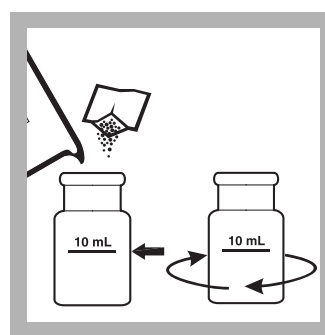

3. **Prepared Sample:** Fill one clean, square sample cell with 10 mL of sample. Add the contents of one 10-mL TPTZ Iron Reagent Powder Pillow to the prepared sample. Swirl at least 30 seconds to dissolve.

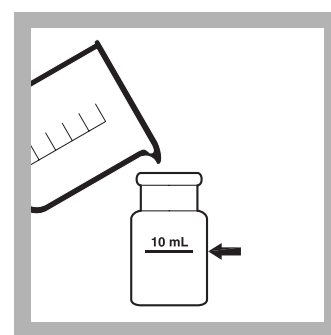

4. **Blank Preparation:** Fill a second square sample cell with 10 mL of deionized water

Iron, Total (0.012 to 1.800 mg/L)

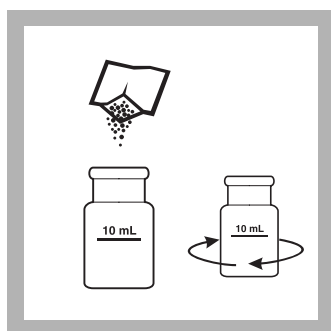

5. Add the contents of one 10-mL TPTZ Iron Reagent Powder Pillow to the reagent blank. Swirl at least 30 seconds to dissolve.

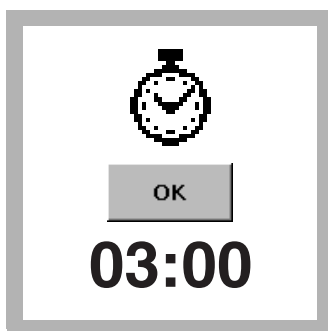

6. Press **TIMER>OK**. A three-minute reaction period will begin. Proceed to step 7 while the timer is running.

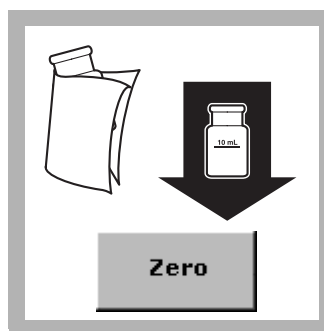

7. When the timer expires, insert the blank into the cell holder with the fill line facing right. Press **ZERO**. The display will show: 0.000 mg/L Fe

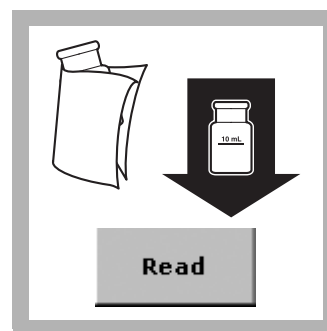

8. Insert the prepared sample into the cell holder with the fill line facing right. Press **READ**. Results are in mg/L Fe.

TPTZ AccuVac® Ampul

Method 8112

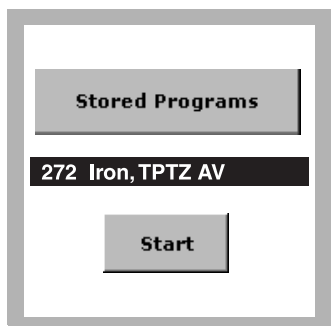

1. Select the test.

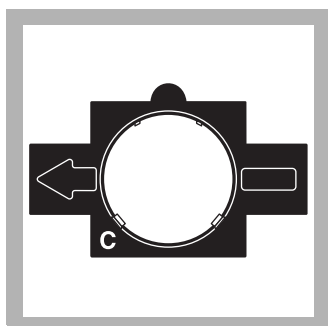

2. Insert Adapter C.

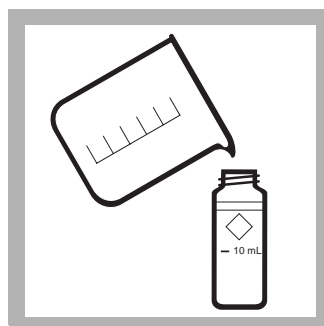

3. **Blank Preparation:** Fill a round sample cell with 10 mL of sample.

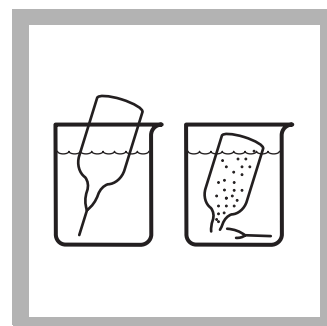

4. **Prepared Sample:** Collect at least 40 mL of sample in a 50-mL beaker. Fill a TPTZ Iron AccuVac® Ampul with sample. Keep the tip immersed while the Ampul fills completely.



5. Invert the Ampul repeatedly to mix.

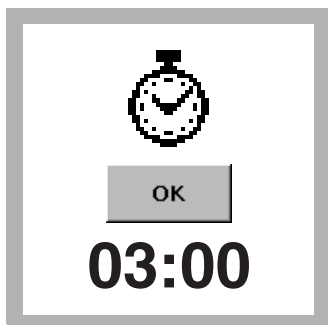

6. Press **TIMER>OK**. A three-minute reaction period will begin. Complete step 7 during this period.

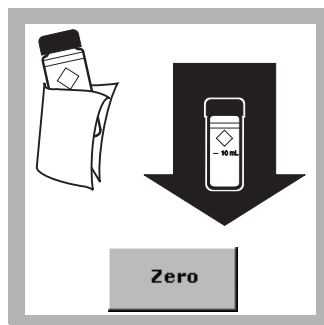

7. When the timer expires, insert the blank into the adapter. Press **ZERO**. The display will show: 0.000 mg/L Fe



8. Insert the prepared sample into the adapter. Press **READ**. Results are in mg/L Fe.

Interferences

Interference tests (Table 1) were performed using an iron concentration of 0.5 mg/L. When interferences occurred, the color formation was inhibited or a precipitate formed. The following do not interfere with the test when present up to the levels given.

Table 1 Interfering Substances and Levels

Interfering Substance	Interference Levels and Treatments
Cadmium	4.0 mg/L
Chromium (3+)	0.25 mg/L
Chromium (6+)	1.2 mg/L
Cobalt	0.05 mg/L
Copper	0.6 mg/L
Cyanide	2.8 mg/L
Manganese	50.0 mg/L
Mercury	0.4 mg/L
Molybdenum	4.0 mg/L
Nickel	1.0 mg/L
Nitrite Ion	0.8 mg/L
Color or turbidity	In the powder pillow procedure, if the sample, without a TPTZ Iron Reagent Powder Pillow, has a color or turbidity greater than the blank (deionized water plus TPTZ Iron Reagent), then use the sample as the blank.
pH	A sample pH of less than 3 or greater than 4 after the addition of reagent may inhibit color formation, cause the developed color to fade quickly, or to result in turbidity. Adjust the sample pH in the sample cell before the addition of reagent to between 3 and 4 by using a pH meter or pH paper and adding dropwise an appropriate amount of iron-free acid or base such as 1.0 N Sulfuric Acid Standard Solution ¹ or 1.0 N Sodium Hydroxide Standard Solution ¹ . Make a volume correction if significant volumes of acid or base are used.

¹ See [Optional Reagents and Apparatus on page 5](#).

Sample Collection, Storage, and Preservation

Collect samples in acid-washed glass or plastic bottles. To preserve samples, adjust the sample pH to 2 or less with about 2 mL/L Nitric Acid, ACS*. Store preserved samples up to six months at room temperature. If reporting only dissolved iron, filter sample immediately after collection and before adding nitric acid.

Before testing, adjust the pH of the stored sample to between 3–4 with 5.0 N Sodium Hydroxide Standard Solution*. Do not exceed pH 5 as iron may precipitate. Correct the test result for volume additions.

* See [Optional Reagents and Apparatus on page 5](#).

Accuracy Check

Standard Additions Method (Sample Spike)

1. After reading test results, leave the sample cell (unspiked sample) in the instrument.
2. Press **OPTIONS>MORE**. Press **STANDARD ADDITIONS**. A summary of the standard additions procedure will appear.
3. Press **OK** to accept the default values for standard concentration, sample volume, and spike volumes. Press **EDIT** to change these values. After values are accepted, the unspiked sample reading will appear in the top row. See the user manual for more information.
4. Open a fresh bottle of Iron Standard Solution, 10-mg/L Fe.
5. Prepare three sample spikes. Fill three sample cells with 10 mL of sample. Use the TenSette® Pipet to add 0.1 mL, 0.2 mL, and 0.3 mL of standard, respectively, to each sample and mix thoroughly.

Note: For AccuVac® Ampuls, fill three mixing cylinders* each with 50-mL of sample and spike with 0.5 mL, 1.0 mL, and 1.5 mL of standard. Transfer 40 mL from each of the three mixing cylinders to three 50-mL beakers. Analyze each standard addition sample as described in the procedure above. Accept each standard additions reading by pressing **READ**. Each addition should reflect approximately 100% recovery.

6. Analyze each sample spike as described in the procedure above, starting with the 0.1 mL sample spike. Accept each standard additions reading by pressing **READ**. Each addition should reflect approximately 100% recovery.
7. After completing the sequence, press **GRAPH** to view the best-fit line through the standard additions data points, accounting for matrix interferences. Press **IDEAL LINE** to view relationships between the sample spikes and the “Ideal Line” of 100% recovery.

Standard Solution Method

1. Using Class A glassware, prepare a 1.000-mg/L iron standard solution by pipetting 5.00 mL of Iron Standard Solution, 100-mg/L, into a 500-mL volumetric flask. Dilute to the mark with deionized water. Prepare this solution daily. Perform the iron procedure as described above.
2. To adjust the calibration curve using the reading obtained with the standard solution, press **OPTIONS>MORE** on the current program menu. Press **STANDARD ADJUST**.
3. Press **ON**. Press **ADJUST** to accept the displayed concentration. If an alternate concentration is used, press the number in the box to enter the actual concentration, then press **OK**. Press **ADJUST**.

Summary of Method

The TPTZ Iron Reagent forms a deep blue-purple color with ferrous iron. The indicator is combined with a reducing agent which converts precipitated or suspended iron, such as rust, to the ferrous state. The amount of ferric iron present can be determined as the difference between the results of a ferrous iron test and the concentration of total iron. Test results are measured at 590 nm.

* See [Optional Reagents and Apparatus on page 5](#).

Consumables and Replacement Items

Required Reagents

Description	Quantity/Test	Unit	Cat. No.
TPTZ Iron Reagent Powder Pillows (for 10-mL sample)	1	100/pkg	26087-99
OR			
TPTZ Low Range Iron Reagent AccuVac® Ampuls	1	25/pkg	25100-25

Required Apparatus (Powder Pillows)

Description	Quantity/Test	Unit	Cat. No.
Sample Cells, 1-inch square, 10 mL, matched pair	2	2/pkg	24954-02

Required Apparatus (AccuVac)

Description	Quantity/Test	Unit	Cat. No.
Adapter, 1-inch round, for AccuVac Ampuls	1	each	LZV584
Beaker, 50-mL	1	each	500-41H
Sample Cell, 10-mL, with cap	1	each	21228-00

Recommended Standards

Description	Unit	Cat. No.
Iron Standard Solution, 100-mg/L Fe	100 mL	14175-42
Iron Standard Solution, 10-mg/L Fe	500 mL	140-49
Metals Drinking Water Standard, LR for Cu, Fe, Mn	500 mL	28337-49
Metals Drinking Water Standard, HR for Cu, Fe, Mn	500 mL	28336-49
Water, deionized	4 L	272-56

Optional Reagents and Apparatus

Description	Cat. No.
Cylinder, mixing, 50 mL	1896-41
Nitric Acid, concentrated	152-49
Sodium Hydroxide, 5.0 N	2450-26
Sodium Hydroxide Standard Solution, 1.0 N	1270-32
Sulfuric Acid, 1.0 N	1045-32



FOR TECHNICAL ASSISTANCE, PRICE INFORMATION AND ORDERING:

In the U.S.A. – Call toll-free 800-227-4224
Outside the U.S.A. – Contact the HACH office or distributor serving you.
On the Worldwide Web – www.hach.com; E-mail – techhelp@hach.com

HACH COMPANY
WORLD HEADQUARTERS
Telephone: (970) 669-3050
FAX: (970) 669-2932

Iron, Total

Method 8365

FerroMo Method¹

Powder Pillows

(0.01 to 1.80 mg/L)

Scope and Application: For cooling water containing molybdate-based treatment

¹ Adapted from G. Frederick Smith Chemical Co., *The Iron Reagents*, 3rd ed. (1980)



Test Preparation

Before starting the test:

For more accurate results, determine a reagent blank value for each new lot of reagent. Follow the procedure using deionized water instead of the sample. Subtract the reagent blank value from the final results or perform a reagent blank adjust.

Rinse glassware with a 1:1 hydrochloric acid solution. Rinse again with deionized water. These two steps will remove iron deposits that can cause slightly high results.

After the addition of the reagent, the sample pH should be between 3–5.

If the sample contains high levels of molybdate (100 mg/L MoO_4^{2-} or greater), read the sample immediately after zeroing the blank.

Collect the following items:

Quantity

FerroMo® Reagent 1 Powder Pillow	1
FerroMo® Reagent 2 Powder Pillow	1
Cylinder, graduated mixing, 25-mL, with stopper	1
Cylinder, graduated mixing, 50-mL, with stopper	1
Sample Cells, 1-inch square, 10 mL, matched pair	2

Note: Reorder information for consumables and replacement items is on page 4.

Note: Digestion is required for total iron determination.

Powder Pillows

Method 8365

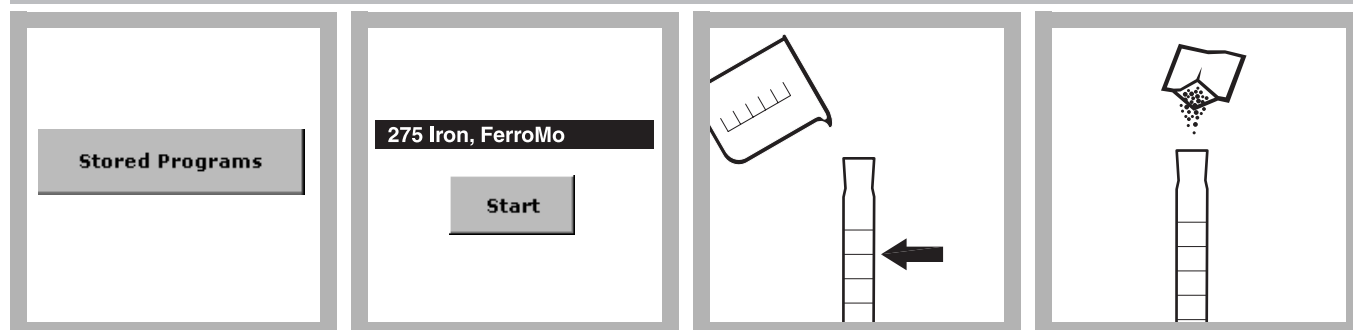

1. Press
STORED PROGRAMS.

2. Select the test.

3. **Prepared Sample:**
Fill a 50-mL graduated
mixing cylinder with 50 mL
of sample.

4. Add the contents of
one FerroMo Iron
Reagent 1 Powder Pillow
to the graduated mixing
cylinder. Stopper.

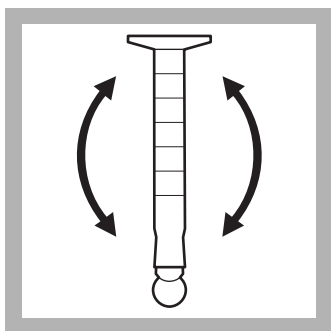

5. Invert several times to dissolve the reagents.

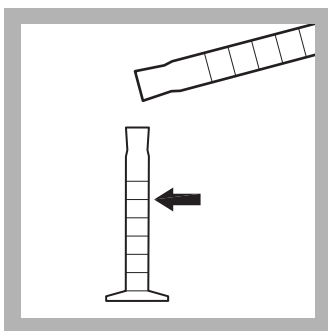

6. Fill a clean, 25-mL graduated cylinder to the 25-mL mark with prepared sample. Save the remaining prepared sample for step 10.

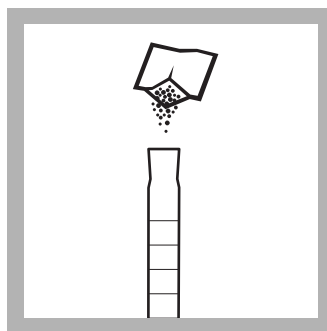

7. **Developed Sample:** Add the contents of one FerroMo Iron Reagent 2 Powder Pillow to the sample in the 25-mL mixing cylinder. Stopper and invert to dissolve the reagents. A blue color will develop if iron is present.
Note: A small amount of undissolved reagent will not affect the results.

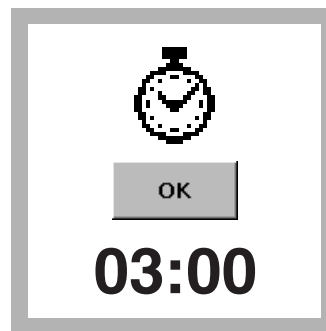

8. Press **TIMER>OK**. A three-minute reaction period will begin.

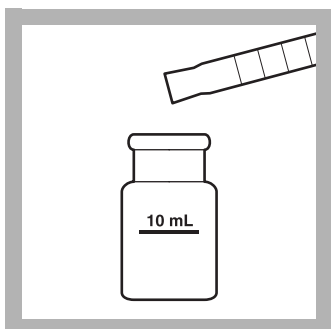

9. When the timer expires, pour the developed sample from step 7 into a square sample cell.

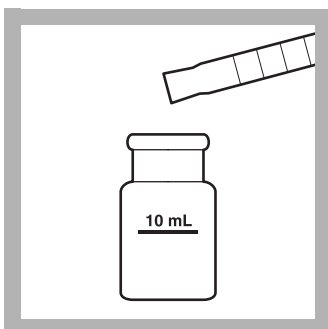

10. **Blank Preparation:** Fill a second square sample cell with the remaining prepared sample from step 6.

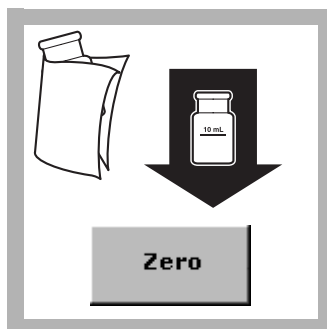

11. When the timer expires, insert the blank into the cell holder with the fill line facing right. Press **ZERO**.
The display will show: 0.00 mg/L Fe



12. Insert the developed sample into the cell holder with the fill line facing right. Press **READ**. Results are in mg/L Fe.

Interferences

Table 1 Interfering Substances and Levels

Interfering Substance	Interference Levels and Treatments
pH	A sample pH of less than 3 or greater than 4 after the addition of reagent may inhibit color formation, cause the developed color to fade quickly, or result in turbidity. Adjust the sample pH in the graduated cylinder before the addition of reagent to between 3 and 8 by using a pH meter or pH paper and adding, dropwise, an appropriate amount of iron-free acid or base such as 1.0 N Sulfuric Acid Standard Solution ¹ or 1.0 N Sodium Hydroxide Standard Solution ¹ . Make a volume correction if significant volumes of acid or base are used.

¹ See [Optional Reagents and Apparatus on page 4](#).

Sample Collection, Storage, and Preservation

Collect samples in acid-washed glass or plastic bottles. To preserve samples, adjust the sample pH to 2 or less with hydrochloric acid (about 2 mL per liter)*. Samples preserved in this manner can be stored up to six months at room temperature. If only dissolved iron is to be reported, filter sample immediately after collection through a 0.45-micron filter or equivalent medium before adding hydrochloric acid.

Before testing, adjust the sample pH to 3–5 with 5.0 N Sodium Hydroxide Standard Solution*. Do not exceed pH 5 as iron may precipitate. Correct test results for volume additions.

Accuracy Check

Standard Additions Method (Sample Spike)

1. After reading test results, leave the sample cell (unspiked sample) in the instrument.
2. Press **OPTIONS>MORE**. Press **STANDARD ADDITIONS**. A summary of the standard additions procedure will appear.
3. Press **OK** to accept the default values for standard concentration, sample volume, and spike volumes. Press **EDIT** to change these values. After values are accepted, the unspiked sample reading will appear in the top row. See the user manual for more information.
4. Open an Iron Voluette® Ampule Standard, 50-mg/L Fe.
5. Prepare three sample spikes. Fill three mixing cylinders* with 50 mL of sample. Use the TenSette® Pipet to add 0.1 mL, 0.2 mL, and 0.3 mL of standard, respectively, to each sample and mix thoroughly.
6. Analyze each sample spike as described in the procedure above, starting with the 0.1 mL sample spike. The iron concentration should increase by 0.10 mg/L. Accept each standard additions reading by pressing **READ**. Each addition should reflect approximately 100% recovery.
7. After completing the sequence, press **GRAPH** to view the best-fit line through the standard additions data points, accounting for the matrix interferences. Press **IDEAL LINE** to view the relationship between the sample spikes and the "Ideal Line" of 100% recovery.

Standard Solution Method

1. Using Class A glassware, prepare a 1.00-mg/L iron standard solution by pipetting 10.0 mL of Iron Standard Solution, 100-mg/L, into a 1-liter volumetric flask. Dilute to the mark with deionized water. Prepare this solution daily. Perform the iron procedure as described above.
2. To adjust the calibration curve using the reading obtained with the standard solution, press **OPTIONS>MORE** on the current program menu. Press **STANDARD ADJUST**.
3. Press **ON**. Press **ADJUST** to accept the displayed concentration. If an alternate concentration is used, press the number in the box to enter the actual concentration, then press **OK**. Press **ADJUST**.

* See [Optional Reagents and Apparatus on page 4](#).

Iron, Total (0.01 to 1.80 mg/L)

Summary of Method

FerroMo Iron Reagent 1 contains a reducing agent combined with a masking agent. The masking agent eliminates interference from high levels of molybdate. The reducing agent converts precipitated or suspended iron, such as rust, to the ferrous state. FerroMo Iron Reagent 2 contains the indicator combined with a buffering agent. The indicator reacts with ferrous iron in the sample, buffered between pH 3 and 5, resulting in a deep blue-purple color. Test results are measured at 590 nm.

Consumables and Replacement Items

Required Reagents

Description	Quantity/Test	Unit	Cat. No.
FerroMo® Iron Reagent Set (100 tests), includes:	—	—	25448-00
(4) FerroMo® Reagent 1 Powder Pillows	1	25/pkg	25437-68
(2) FerroMo® Reagent 2 Powder Pillows	1	50/pkg	25436-66

Required Apparatus

Description	Quantity/Test	Unit	Cat. No.
Cylinder, graduated mixing, 25-mL, with stopper	1	each	20886-40
Cylinder, graduated mixing, 50-mL, with stopper	1	each	20886-41
Sample Cells, 1-inch square, 10 mL, matched pair	2	2/pkg	24954-02

Recommended Standards

Description	Unit	Cat. No.
Iron Standard Solution, 100-mg/L	100 mL	14175-42
Iron Standard Solution, 10-mL Voluette® ampule, 50-mg/L Fe.	16/pkg	14254-10
Water, deionized	4 L	272-56

Optional Reagents and Apparatus

Description	Cat. No.
Cylinder, mixing	20886-41
Flask, volumetric, Class A	14574-53
Pipet, volumetric, Class A, 10.0 mL	14515-38
Pipet Filler, safety bulb	14651-00
Sodium Hydroxide Standard Solution, 1.0 N	1045-32
Sodium Hydroxide Standard Solution, 5.0 N	2450-32
Sulfuric Acid Standard Solution, 1.0 N	1270-32
Sodium Hydroxide Standard Solution, 5.0 N	2450-32



FOR TECHNICAL ASSISTANCE, PRICE INFORMATION AND ORDERING:
In the U.S.A. – Call toll-free 800-227-4224
Outside the U.S.A. – Contact the HACH office or distributor serving you.
On the Worldwide Web – www.hach.com; E-mail – techhelp@hach.com

HACH COMPANY
WORLD HEADQUARTERS
Telephone: (970) 669-3050
FAX: (970) 669-2932

Iron, Total

★Method 8008

FerroVer® Method¹

Powder Pillows or AccuVac® Ampuls

(0.02 to 3.00 mg/L)

Scope and Application: For water, wastewater, and seawater; digestion is required for determining total iron; USEPA approved for reporting wastewater analysis²

¹ Adapted from *Standard Methods for the Examination of Water and Wastewater*

² *Federal Register*, June 27, 1980; 45 (126:43459)



Test Preparation

Before starting the test:

Digestion is required for determining total iron for EPA reporting purposes.

For more accurate results, determine a reagent blank value for each new lot of reagent. Follow the procedure using deionized water in place of the sample. Subtract the reagent blank value from the final results or perform a reagent blank adjust. See the user manual for more information.

Collect the following items:

Quantity

Collect the following items:	Quantity
Powder Pillow Test:	
FerroVer® Iron Reagent Powder Pillow	1
Sample Cells, 1-inch square, 10 mL	2
Beaker, 50-mL	1
FerroVer® Iron Reagent AccuVac® Ampul	
Beaker, 50-mL	1
Sample Cells, 10-mL, with cap	1

Note: Reorder information for consumables and replacement items is on page 6.

Powder Pillows

Method 8008



1. Press **STORED PROGRAMS**.

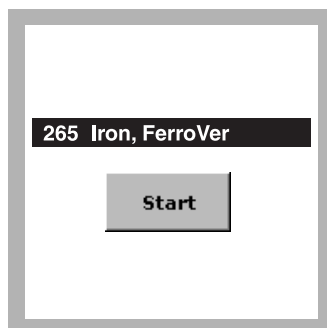

2. Select the test.

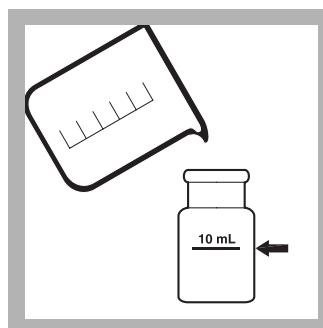

3. **Prepared Sample:** Fill a clean square sample cell with 10 mL of sample.

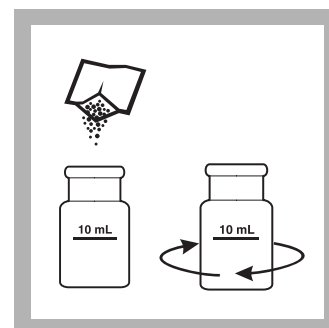

4. Add the contents of one FerroVer Iron Reagent Powder Pillow to the sample cell. Swirl to mix.

An orange color will form, if iron is present

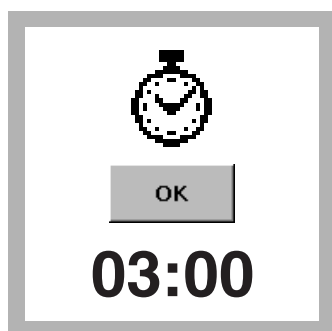

5. Press TIMER>OK.

A three-minute reaction period will begin.

(Allow samples that contain rust to react for at least 5 minutes.)

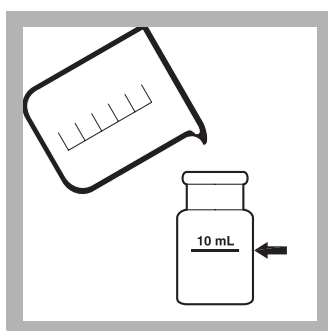

6. Blank Preparation:

Fill a second square sample cell with 10 mL of sample.



7. When the timer expires, insert the blank into the cell holder with the fill line facing right.

Press **ZERO**.

The display will show:

0.00 mg/L Fe

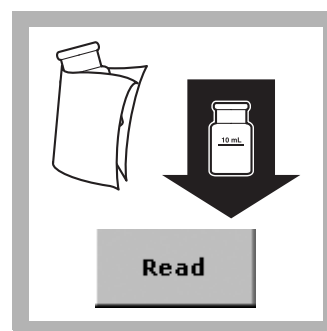

8. Place the prepared sample into the cell holder with the fill line facing right.

Press **READ**. Results are in mg/L Fe.

AccuVac Ampul

Method 8008

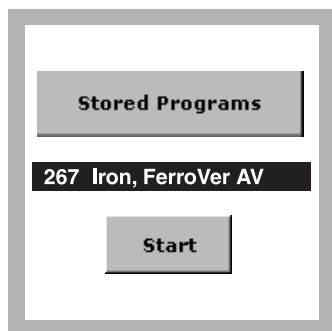

1. Select the test.

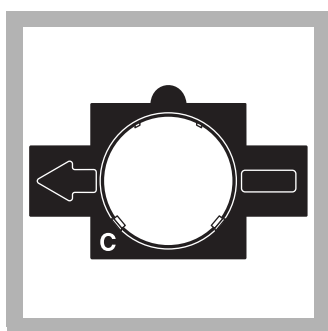

2. Insert Adapter C.

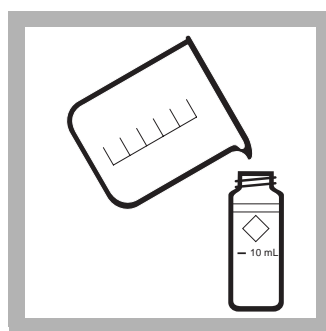

3. Blank Preparation:

Fill a round sample cell with 10 mL of sample.

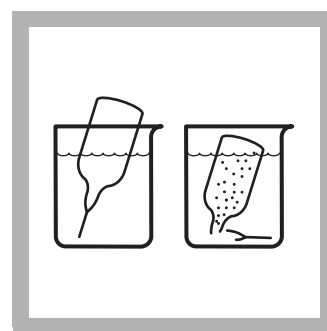

4. Prepared Sample:

Collect at least 40 mL of sample in a 50-mL beaker.

Fill a FerroVer Iron AccuVac® Ampul with sample.

Keep the tip immersed while the Ampul fills completely.

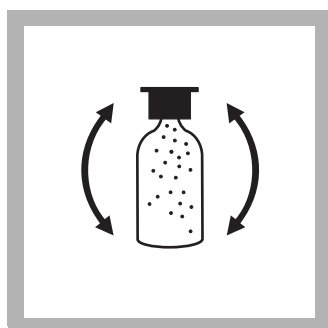

5. Quickly invert the Ampul several times to mix.

Wipe off all liquid and fingerprints.

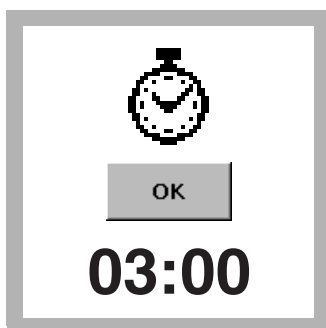

6. Press **TIMER>OK**.

A three-minute reaction period will begin.

(Allow samples that contain rust to react for at least 5 minutes.)

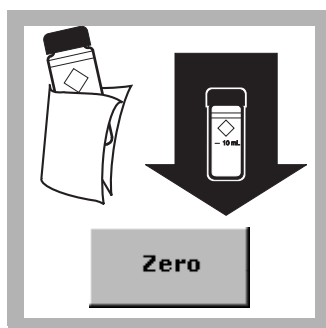

7. When the timer expires, insert the blank into the cell holder.

Press **ZERO**.

The display will show:

0.00 mg/L Fe



8. Insert the AccuVac Ampul into the cell holder.

Press **READ**. Results are in mg/L Fe.

Interferences

Table 1 Interfering Substances and Levels

Interfering Substance	Interference Levels and Treatments
Calcium, Ca ²⁺	No effect at less than 10,000 mg/L as CaCO ₃ .
Chloride, Cl ⁻	No effect at less than 185,000 mg/L.
Copper, Cu ²⁺	No effect. Masking agent is contained in FerroVer Reagent.
High Iron Levels	Inhibit color development. Dilute sample and re-test to verify results.
Iron Oxide	Requires mild, vigorous or Digesdahl digestion. After digestion, adjust sample to pH 3–5 with sodium hydroxide, then analyze.
Magnesium	No effect at 100,000 mg/L as calcium carbonate.
Molybdate Molybdenum	No effect at 50 mg/L as Mo.
High Sulfide Levels, S ²⁻	<ol style="list-style-type: none"> 1. Treat in fume hood or well-ventilated area. Add 5 mL hydrochloric acid¹, ACS to 100 mL sample in a 250-mL Erlenmeyer flask. Boil 20 minutes. 2. Cool. Adjust pH to 3–5 with Sodium Hydroxide¹. Readjust volume to 100 mL with deionized water. 3. Analyze.
Turbidity	<ol style="list-style-type: none"> 1. Add 0.1 g scoop of RoVer[®] Rust Remover to the blank. Swirl to mix. 2. Zero the instrument with this blank. 3. If sample remains turbid, add three 0.2 g scoops of RoVer to a 75-mL sample. Let stand 5 minutes. 4. Filter through a Glass Membrane Filter and Filter Holder¹. 5. Use filtered sample in steps 6 and 3.
Extreme Sample pH	Adjust pH to 3–5.
Highly Buffered Samples	Adjust pH to 3–5.

¹ See [Optional Reagents and Apparatus on page 6](#).

Sample Collection, Storage, and Preservation

Collect samples in acid-cleaned glass or plastic containers. No acid addition is necessary if analyzing the sample immediately. To preserve samples, adjust the pH to 2 or less with concentrated nitric acid (about 2 mL per liter). Preserved samples may be stored up to six months at room temperature. Before analysis, adjust the pH to between 3 and 5 with 5.0 N Sodium Hydroxide Standard Solution. Correct the test result for volume additions.

If only dissolved iron is to be determined, filter the sample before acid addition.

Accuracy Check

Standard Additions Method (Sample Spike)

1. After reading test results, leave the sample cell (unspiked sample) in the instrument.
2. Press **OPTIONS>MORE**. Press **STANDARD ADDITIONS**. A summary of the standard additions procedure will appear.
3. Press **OK** to accept the default values for standard concentration, sample volume, and spike volumes. Press **EDIT** to change these values. After values are accepted, the unspiked sample reading will appear in the top row. See the user manual for more information.
4. Snap the neck off an Iron Voluette Ampule Standard, 25-mg/L.
5. Prepare a 0.1 mL sample spike by adding 0.1 mL of standard to the unspiked sample. Press the timer icon. After the timer expires, read the result.
6. Prepare a 0.2 mL sample spike by adding 0.1 mL of standard to the 0.1 mL sample spike. Press the timer icon. After the timer expires, read the result.
7. Prepare a 0.3 mL sample spike by adding 0.1 mL of standard to the 0.2 mL sample spike. Press the timer icon. After the timer expires, read the result. Each addition should reflect approximately 100% recovery.

Note: For AccuVac® Ampuls, fill three mixing cylinders* with 50-mL of sample and spike with 0.2 mL, 0.4 mL, and 0.6 mL of standard. Transfer 40 mL from each of the three mixing cylinders to three 50-mL beakers*. Analyze each standard addition sample as described in the procedure above. Accept each standard additions reading by pressing **READ**. Each addition should reflect approximately 100% recovery.

8. After completing the sequence, press **GRAPH** to view the best-fit line through the standard additions data points, accounting for matrix interferences. Press **IDEAL LINE** to view relationships between the sample spikes and the “Ideal Line” of 100% recovery.

* See [Optional Reagents and Apparatus on page 6](#).

Standard Solution Method

1. Prepare a 2.00-mg/L Fe standard solution by pipetting 2.00 mL of Iron Standard Solution, 100-mg/L, into a 100-mL volumetric flask. Dilute to the mark with deionized water. Stopper and invert to mix. Prepare this solution daily. Perform the iron procedure as described above.
2. To adjust the calibration curve using the reading obtained with the standard solution, press **OPTIONS>MORE** on the current program menu. Press **STANDARD ADJUST**.
3. Press **ON**. Press **ADJUST** to accept the displayed concentration. If an alternate concentration is used, press the number in the box to enter the actual concentration, then press **OK**. Press **ADJUST**.

Summary of Method

FerroVer Iron Reagent converts all soluble iron and most insoluble forms of iron in the sample to soluble ferrous iron. The ferrous iron reacts with the 1,10 phenanthroline indicator in the reagent to form an orange color in proportion to the iron concentration. Test results are measured at 510 nm.

Iron, Total (0.02 to 3.00 mg/L)

Consumables and Replacement Items

Required Reagents

Description	Quantity/Test	Unit	Cat. No.
FerroVer® Iron Reagent Powder Pillows (for 10-mL sample)	1	100/pkg	21057-69
OR			
FerroVer® Iron Reagent AccuVac® Ampuls	1	25/pkg	25070-25

Required Apparatus (Powder Pillows)

Description	Quantity/Test	Unit	Cat. No.
Sample Cells, 1-inch square, 10 mL, matched pair	2	2/pkg	24954-02

Required Apparatus (AccuVacs)

Description	Quantity/Test	Unit	Cat. No.
Adapter, 1-inch round, for AccuVac Ampuls	1	each	LZV584
Beaker, 50-mL	1	each	500-41H
Sample Cells, 10-mL, with cap	1	each	21228-00

Recommended Standards and Apparatus

Description	Unit	Cat. No.
Iron Standard Solution, 100-mg/L	100 mL	14175-42
Iron Standard Solution, 10-mL Voluette® Ampule, 25-mg/L as Fe	16/pkg	14253-10
Metals Drinking Water Standard, LR for Cu, Fe, Mn	500 mL	28337-49
Metals Drinking Water Standard, HR for Cu, Fe, Mn	500 mL	28336-49
Water, deionized	4 L	272-56
Pipet, TenSette, 0.1–1.0 mL	each	19700-01
Pipet Tips, for TenSette Pipet 19700-01	50/pkg	21856-96
Pipet Tips, for TenSette Pipet 19700-01	1000/pkg	21856-28
Flask, volumetric, Class A, 100 mL	each	14574-42
Pipet, volumetric, Class A, 2.00 mL	each	14515-36
Pipet Filler, safety bulb	each	14651-00

Optional Reagents and Apparatus

Description	Cat. No.
Beaker, 50-mL	500-41H
Cylinder, mixing	1896-41
Hydrochloric Acid, concentrated	134-49
Nitric Acid, concentrated	152-49
Sodium Hydroxide Standard Solution, 5.0 N	2450-32
Glass Membrane Filter	2530-00
Glass Membrane Filter Holder	2340-00



FOR TECHNICAL ASSISTANCE, PRICE INFORMATION AND ORDERING:
In the U.S.A. – Call toll-free 800-227-4224
Outside the U.S.A. – Contact the HACH office or distributor serving you.
On the Worldwide Web – www.hach.com; E-mail – techhelp@hach.com

HACH COMPANY
WORLD HEADQUARTERS
Telephone: (970) 669-3050
FAX: (970) 669-2932

Scope and Application: For drinking water

¹ Patent Number 5,019,516



Test Preparation

Before starting the test:

For more accurate results, determine a reagent blank value for each new lot of reagent. Follow the procedure using deionized water instead of the sample. Subtract the reagent blank value from the final results or perform a reagent blank adjust.

The sampling requirements for “first-draw” analysis are detailed in [Sample Collection, Storage, and Preservation on page 5](#).

Reagents will stain the sample cells, rinse the cells with 1:1 HNO₃, followed by deionized water.

Collect the following items:

Quantity

LeadTrak [®] Reagent Set	1
Beaker, polypropylene, 150-mL	2
Beaker, polypropylene, 250-mL	1
Clamp, 2-prong extension, with clamp holder	1
Cylinder, graduated polypropylene, 25-mL	1
Cylinder, graduated polypropylene, 100-mL	1
Dropper, 0.5 and 1.0 mL marks	1
Sample Cells, 1-inch square	1
Support for Ring Stand	1

Note: Reorder information for consumables and replacement items is on [page 8](#).

Fast Column Extraction

Method 8317



1. Press **STORED PROGRAMS**.



2. Select the test.

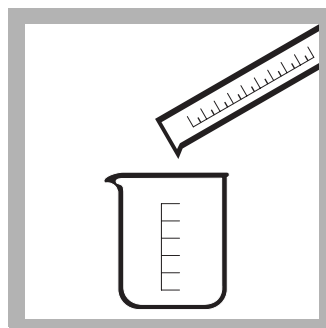

3. Fill a 100-mL plastic graduated cylinder with 100 mL of the sample. Pour the measured sample into a 250-mL plastic beaker.

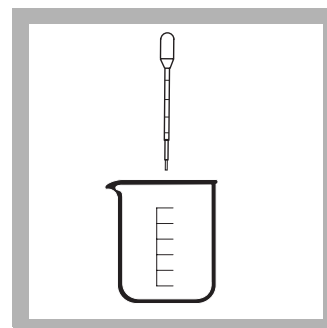

4. Using a plastic 1-mL dropper, add 1.0 mL of pPb-1 Acid Preservative Solution to the sample and swirl to mix.

If the sample has been preserved previously with pPb-1 Acid Preservative at a ratio of 1.0 mL per 100 mL sample, omit steps 4 and 5.

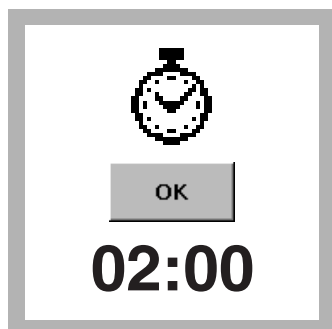

5. Press **TIMER>OK**.
A two-minute reaction period will begin.

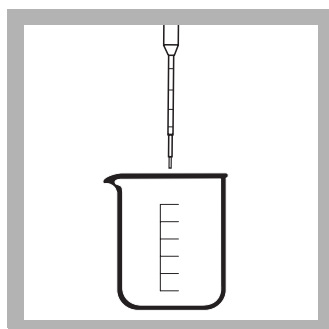

6. When the timer expires, use a second 1-mL plastic dropper to add 2.0 mL of pPb-2 Fixer Solution. Swirl to mix.

Field samples that have been preserved with nitric acid or samples that have been digested may exceed the buffer capacity of the Fixer Solution. After step 6, check the pH of these samples and adjust with 5 N Sodium Hydroxide to a pH of 6.7–7.1 before proceeding with step 7.

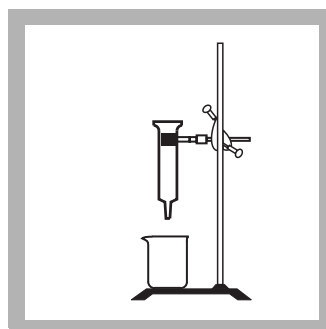

7. Mount a new Fast Column Extractor in a ring stand with a clamp. Place a 150-mL plastic beaker under the Extractor.

A Fast Column Extractor is included in the LeadTrak® Reagent Set. A new extractor is required for each test.

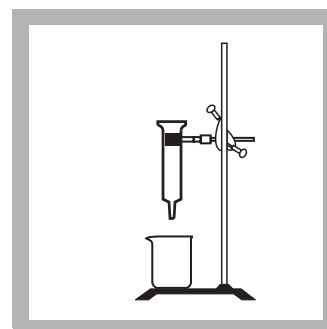

8. Soak the cotton plug with deionized water and compress it with the plunger. Remove the plunger. If the cotton plug moves up the column, push it back to the bottom with a clean, blunt rod.

The cotton plug should fit snugly against the inner wall of the column.

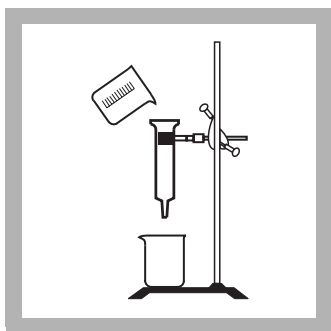

9. Pour the prepared sample slowly into the center of the Column Extractor. Wait for the sample to flow through.

The sample solution should flow relatively slowly (2 drops per second) through the column.

Keep the level of the sample solution just above the cotton plug.

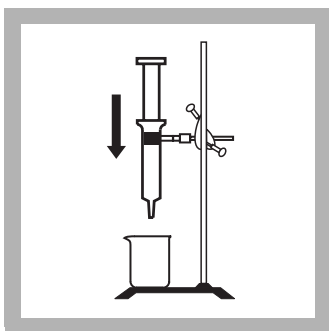

10. After the flow has stopped, fully compress the absorbent pad in the Extractor with the plunger. Discard the contents of the beaker. Slowly withdraw the plunger from the Extractor.

The absorbent pad should remain at the bottom of the Extractor when the plunger is removed. If the cotton plug moves up the column, push it back to the bottom with a clean, blunt rod.

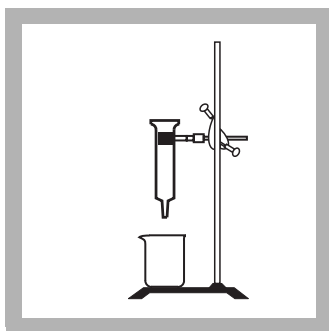

11. Place a clean, dry 150-mL beaker under the Extractor. Using a 25-mL plastic graduated cylinder, add 25 mL of pPb-3 Eluent Solution to the Extractor.

Keep the level of the eluent solution just above the absorbent pad.

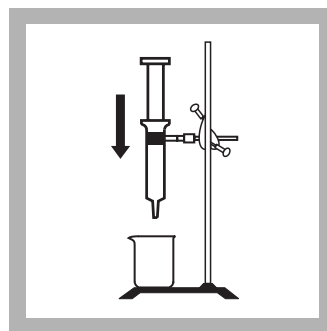

12. Allow the Eluent Solution to drip slowly from the Extractor.

After the flow has stopped, fully compress the absorbent pad.

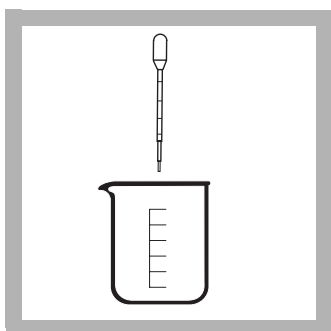

13. Using a 1-mL plastic dropper, add 1.0 mL of pPb-4 Neutralizer Solution to the beaker. Swirl thoroughly to mix and proceed immediately to step 14.

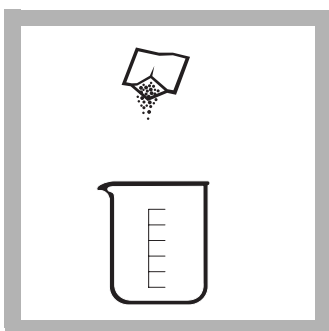

14. Add the contents of one pPb-5 Indicator Powder Pillow to the beaker and swirl thoroughly to mix.

The solution will turn brown.

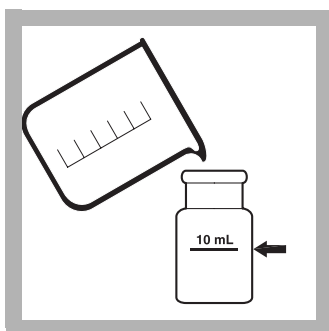

15. Pour 10 mL of solution into a square sample cell.

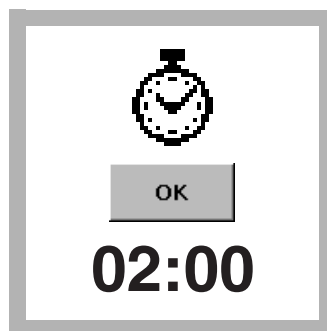

16. Press **TIMER>OK**.

A second two-minute reaction period will begin.



17. When the timer expires, insert the sample cell into the cell holder with the fill line facing right.

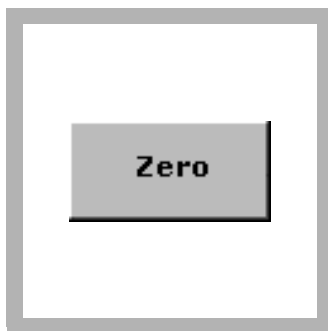

18. Press **ZERO**.
The display will show:
0 µg/L Pb

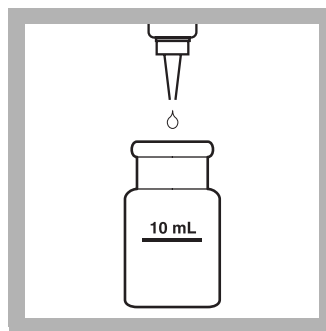

19. Remove the sample cell and add 3 drops of pPb-6 Decolorizer Solution to the cell. Swirl to mix thoroughly.



20. Insert the sample cell into the cell holder with the fill line facing right.
Press **READ**. Results are in µg/L Pb.

Interferences

Interference studies were conducted by preparing a known lead solution of approximately 25 µg/L as well as the potential interfering ion. The ion was said to interfere when the resulting lead concentration changed by ±10%. Samples containing levels exceeding these concentration values may be diluted 1:1 and re-analyzed. Multiply the value obtained by a factor of 2 to determine the lead present in the original sample.

Every effort has been made to prevent contamination in packaging the reagents. Use of black rubber stoppers, black dropper bulbs and droppers with inked graduations may contaminate the sample and should be avoided. Use the plastic droppers provided in the reagent set.

Acid-wash all glassware and plasticware to prevent sample contamination, especially if the previous sample had a high lead level (see [Apparatus and Sample Preparation on page 5](#)).

The Extractor plunger may be reused for more than one test but should be rinsed with lead-free water between uses.

Table 1 Interfering Substances and Levels

Interfering Substance	Interference Levels and Treatments
Aluminum, Al ³⁺	0.5 mg/L
Ammonium, NH ₄ ⁺	500 mg/L
Barium, Ba ²⁺	6 mg/L
Calcium, Ca ²⁺	500 mg/L
Chloride, Cl ⁻	1000 mg/L
Copper, Cu ²⁺	2 mg/L
Fluoride, F ⁻	10 mg/L
Iron, Fe ²⁺	2 mg/L
Magnesium, Mg ²⁺	500 mg/L
Manganese, Mn ²⁺	0.5 mg/L
Nitrate, NO ₃ ⁻	1000 mg/L
Sulfate, SO ₄ ²⁻	1000 mg/L
Zinc, Zn ²⁺	1 mg/L

Apparatus and Sample Preparation

Because lead is very common to our environment, care must be taken to prevent sample contamination. Follow these steps for greatest test accuracy:

- Lead-free water is necessary to minimize sample contamination when rinsing apparatus or diluting sample. The water may be either distilled or deionized. If the water is obtained from a grocery store, verify the lead concentration is zero from the label. If the lead concentration is uncertain, determine the lead concentration with the LeadTrak test.
- Plastic or glass sample containers and lids may be checked for contamination by rinsing with 1 mL of pPb-1 Acid Preservative Reagent*. Add 100 mL of lead-free water. After 24 hours, analyze this solution using the LeadTrak® test to confirm the absence of lead.
- Rinse glassware used in this test with a small amount of dilute lead-free 0.1 N nitric acid or pPb-1 Acid Preservative Reagent followed by rinsing with lead-free water.
- pPb-5 Indicator may be rinsed from the glass sample cells with a few drops of pPb-1 Acid Preservative Reagent or a small amount of dilute lead-free nitric acid.
- Acidify solutions containing lead with Nitric Acid or pPb-1 to below pH 2 to prevent adsorption of lead onto the container walls. See [Sample Collection, Storage, and Preservation](#).

Sample Collection, Storage, and Preservation

Samples may be collected either from household pipes (point-of-use) or from water sources. Preserved samples may be stored up to six months. Each sample type typically requires different sampling procedures. Consult with the appropriate regulatory agency in your area for more information about your specific sampling requirements.

Sampling for Lead Contamination in Household Pipes for Point-of-Use Drinking Water

- The sample should be collected after sitting in pipes with no flow for a minimum of six hours.
- Add 10 mL of pPb-1 Acid Preservative* to a one-liter bottle.
- Turn on tap and collect exactly the first liter of water in the bottle containing acid preservative.
- Cap and invert several times to mix.
- After two minutes the sample is ready for analysis. Steps 4 and 5 are skipped in the analysis procedure. Use 100 mL of this preserved sample directly in step 6.

Sampling for Lead Contamination from Drinking Water Sources Such as Well Water or Water from Main Supply Lines

- Add 10 mL of pPb-1 Acid Preservative* to a one-liter bottle.
- Turn on the tap for 3–5 minutes or until the water temperature has been stable for 3 minutes.
- Collect exactly one liter of water into the bottle containing the acid preservative.

* See [Optional Reagents and Apparatus on page 8](#).

- Cap and invert several times to mix.
- After two minutes the sample is ready for analysis. Steps 4 and 5 are skipped in the analysis procedure. Use 100 mL of this preserved sample directly in step 6.
- At least one liter should be collected to obtain a representative sample. If less than one liter is collected, use 1 mL of pPb-1 Acid Preservative per 100 mL of sample.
- If nitric acid is to be substituted for pPb-1 as a preservative or the sample is digested, the buffering capacity of the pPb-2 Fixer Solution* may be exceeded. Adjust the sample pH to 6.7–7.1 pH with 5 N Sodium Hydroxide* after step 7.

Accuracy Check

Standard Additions Method (Sample Spike)

1. After reading test results, leave the sample cell (unspiked sample) in the instrument.
2. Press **OPTIONS>MORE**. Press **STANDARD ADDITIONS**. A summary of the standard additions procedure will appear.
3. Press **OK** to accept the default values for standard concentration, sample volume, and spike volumes. Press **EDIT** to change these values. After values are accepted, the unspiked sample reading will appear in the top row. See the user manual for more information.
4. Open a container of 10-mg/L (10,000 µg/L) Lead Standard Solution.
5. Prepare three sample spikes. Fill three beakers with 100 mL of sample. Use the TenSette® Pipet to add 0.1 mL, 0.2 mL, and 0.3 mL of standard, respectively, to each sample and mix thoroughly.
6. Analyze each sample spike as described in the procedure above, starting with the 0.1 mL sample spike. Accept each standard additions reading by pressing **READ**. Each addition should reflect approximately 100% recovery.
7. After completing the sequence, press **GRAPH** to view the best-fit line through the standard additions data points, accounting for the matrix interferences. Press **IDEAL LINE** to view the relationship between the sample spikes and the "Ideal Line" of 100% recovery.

*See [Optional Reagents and Apparatus on page 8](#).

Standard Solution Method

Using Class A glassware, prepare a 10-mg/L lead working standard solution by pipetting 1.0 mL of Lead Standard Solution, 1000-mg/L, into a 100-mL volumetric flask. Use a TenSette® Pipet to add 0.2 mL of concentrated nitric acid to the flask. Dilute to the mark with lead-free deionized water. This makes a 10-mg/L working standard.

Pipet 10.00 mL of this working solution into a 1-liter plastic volumetric flask. Dilute to the mark with lead-free water. This 100-µg/L standard solution should be prepared immediately before use. Perform the LeadTrak® procedure as described above.

Alternatively, prepare a 100-µg/L lead standard solution by using a TenSette® Pipet to pipet 0.2 mL from a Lead Voluette® Ampule Standard Solution, 50-mg/L as Pb, into a 100-mL plastic volumetric flask. Dilute to volume with deionized water. Prepare this solution immediately before use.

1. To adjust the calibration curve using the reading obtained with the standard solution, press **OPTIONS>MORE** on the current program menu. Press **STANDARD ADJUST**.
2. Press **ON**. Press **ADJUST** to accept the displayed concentration. If an alternate concentration is used, press the number in the box to enter the actual concentration, then press **OK**. Press **ADJUST**.

Summary of Method

Acid soluble lead, as Pb²⁺, in a potable water sample is first concentrated on a Fast Column Extractor. The lead is then eluted from the Extractor and determined colorimetrically with an indicator. Test results are measured at 477 nm.

Lead (5 to 150 µg/L)

Consumables and Replacement Items

Required Reagents

Description	Quantity/Test	Unit	Cat. No.
LeadTrak® Reagent Set	1	20/pkg	23750-00

Required Apparatus

Description	Quantity/Test	Unit	Cat. No.
Beaker, polypropylene, 150-mL	2	each	1080-44
Beaker, polypropylene, 250-mL	1	each	1080-46
Clamp, 2-prong extension	1	each	21145-00
Clamp Holder	1	each	326-00
Cylinder, graduated polypropylene, 25-mL	1	each	1081-40
Cylinder, graduated polypropylene, 100-mL	1	each	1081-42
Dropper, 0.5 and 1.0 mL marks	1	2/pkg	21247-20
Sample Cells, 1-inch square, 10-mL	1	2/pkg	24954-02
Support for Ring Stand	1	each	563-00

Digestion Reagents and Recommended Standards and Apparatus

Description	Unit	Cat. No.
Flask, volumetric, polypropylene, 1000 mL	each	20995-53
Flask, volumetric, polypropylene, 100 mL	each	20995-42
Lead Standard Solution, 1000-mg/L as Pb	100 mL	12796-42
Lead Standard Solution, 50-mg/L 10-mL Voluette® Ampules	16/pkg	14262-10
Lead Standard Solution, 10-mg/L	25 mL	23748-20
Nitric Acid, ACS	500 mL	152-49
Pipet, TenSette®, 0.1 to 1.0 mL	each	19700-01
Pipet Tips, for TenSette Pipet 19700-01	50/pkg	21856-96
Pipet Tips, for TenSette Pipet 19700-01	1000/pkg	21856-28
Pipet, volumetric, Class A, 1.00 mL	each	14515-35
Pipet Filler, safety bulb	each	14651-00
Pipet, volumetric, 10.00 mL	each	14515-38
Water, deionized	4 L	272-56

Optional Reagents and Apparatus

Description	Cat. No.
pPb-1 Acid Preservative Reagent	23685-31
pPb-2 Fixer Solution	23686-55
Sodium Hydroxide, 5.0 N	2450-53



FOR TECHNICAL ASSISTANCE, PRICE INFORMATION AND ORDERING:
In the U.S.A. – Call toll-free 800-227-4224
Outside the U.S.A. – Contact the HACH office or distributor serving you.
On the Worldwide Web – www.hach.com; E-mail – techhelp@hach.com

HACH COMPANY
WORLD HEADQUARTERS
Telephone: (970) 669-3050
FAX: (970) 669-2932

★ Method 8033

Dithizone Method¹

Powder Pillows

(3 to 300 µg/L)

Scope and Application: For water and wastewater; USEPA accepted for reporting for wastewater analysis (digestion is required).²

¹ Adapted from Snyder, L. J., Analytical Chemistry, 19 684 (1947).

² Procedure is equivalent to Standard Method 3500-Pb D for wastewater analysis.



Test Preparation

Before starting the test:

For more accurate results, determine a reagent blank value for each new lot of reagent. Follow the procedure using deionized water instead of the sample.

Clean all glassware with a 1:1 Nitric Acid Solution. Rinse with deionized water.

Cloudy and turbid samples may require filtering before running the test. Report results as µg/L soluble lead. Use glass membrane type filter to avoid loss of lead by adsorption onto the filter paper.

If samples cannot be analyzed immediately, see [Sample Collection, Preservation, and Storage on page 5](#). Adjust the pH of preserved samples before analysis.

For more accurate results, adjust the sample to pH 11.0–11.5 using a pH meter in step 10. Omit the five additional drops of Sodium Hydroxide Standard Solution in step 11

The DithiVer powder will not completely dissolve in the chloroform. For further notes see [DithiVer Solution Preparation, Storage, and Reagent Blank on page 5](#).

Read the MSDS before testing. Spilled reagent will affect test accuracy and is hazardous to skin and other materials.

In bright light conditions (e.g. direct sunlight) it may be necessary to close the cell compartment with the protective cover during measurements.

Collect the following items:

Quantity

Citrate Buffer Powder Pillows	1
Chloroform	500 mL
DithiVer Metals Reagent Powder Pillows	1
Lead Reagent Set	1
Potassium Cyanide	2 g
Sodium Hydroxide solution, 5.0 N	5 mL
Sodium Hydroxide Standard Solution, 5.0 N	varies
Cotton Balls	1
Clippers	1
Cylinder, 50-mL graduated mixing	1
Cylinder, 5-mL graduated	1
Cylinder, 50-mL graduated	1
Cylinder, 250-mL graduated	1
Funnel, 500-mL separatory	1
Sample Cells, 1-inch square, 25-mL	2
Spoon, measuring, 1.0-g	1
Support Ring (4-inch) and Stand (5 x 8-inch base)	1

Note: Reorder information for consumables and replacement items is on page 6.

Powder Pillows

Method 8033

DANGER

Cyanide is a deadly poison. Use a fume hood. Maintain cyanide solutions at pH 11 or greater to prevent formation of cyanide gas.



1. Press
STORED PROGRAMS.



2. Select the test.

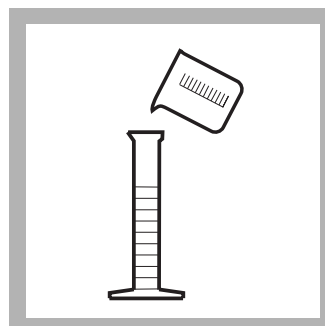

3. Fill a 250-mL
graduated cylinder to the
250-mL mark with sample.

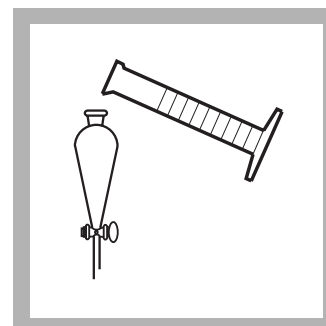

4. Transfer the sample
into 500-mL separatory
funnel.

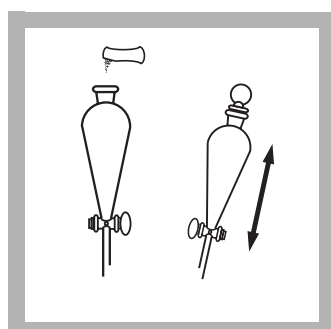

5. Add the contents of
one Buffer Powder Pillow
for heavy metals, citrate
type.

Stopper the funnel and
shake to dissolve.

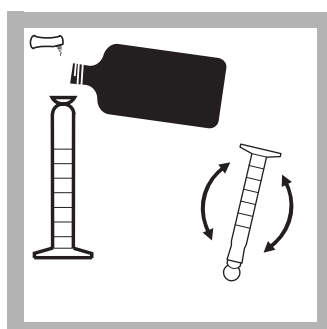

6. **DithiVer Solution
Preparation:**
Add 50 mL of chloroform
to a 50-mL mixing
graduated cylinder. Add
the contents of one
DithiVer Metals Reagent
Powder Pillow.

Stopper the cylinder. Invert
several times to mix.

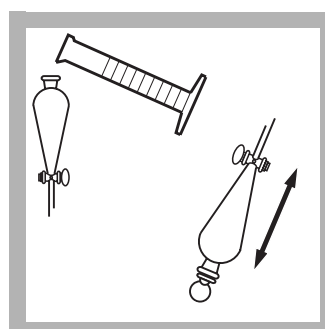

7. Measure 30 mL of the
prepared dithizone
solution with a second
graduated cylinder and
add to the separatory
funnel.

Stopper and invert to mix.
Open stopcock to vent.
Close the stopcock.

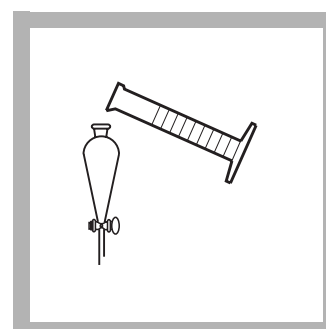

8. Add 5 mL of 5.0 N
Sodium Hydroxide
Standard Solution.

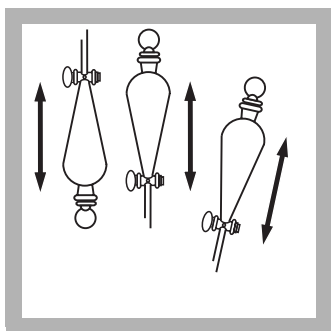

9. Stopper. Invert. Open stopcock to vent. Close the stopcock and shake the funnel once or twice and vent again.

Note: Add a few drops of 5.25 N Sulfuric Acid Standard Solution if the solution turns orange on shaking. The blue-green color will reappear. To avoid higher blanks, repeat procedure on new sample and use less sodium hydroxide in step 8.

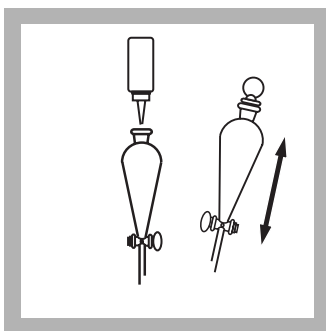

10. Continue adding 5.0 N Sodium Hydroxide Standard Solution dropwise and shaking the funnel after every few drops until the color of the solution being shaken changes from blue-green to orange.

Large amounts of zinc cause the color transition at the end point to be indistinct.

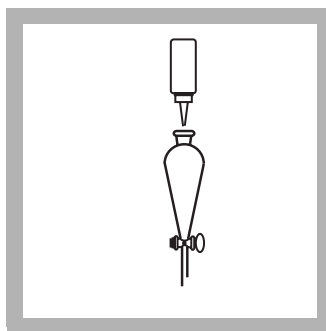

11. Add 5 more drops of 5.0 N Sodium Hydroxide Standard Solution.

A pink color in the bottom (chloroform) layer at this point does not necessarily indicate lead is present. Only after adding the potassium cyanide in the next step will the presence of lead be confirmed by a pink color.

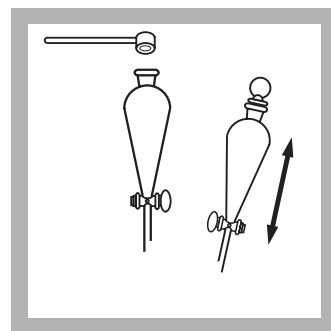

12. Add 2 heaping 1.0-g scoops of potassium cyanide to the funnel. Stopper.

Shake vigorously until the potassium cyanide is all dissolved (about 15 seconds).



13. Wait one minute for the layers to separate. The bottom (chloroform) layer will be pink if lead is present.

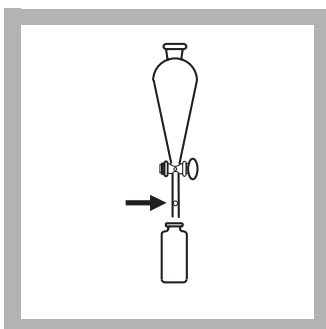

14. Prepared Sample: Insert a cotton plug the size of a pea into the delivery tube of the funnel and slowly drain the bottom (chloroform) layer into a dry 25-mL square sample cell. Stopper.

The lead-dithizone complex is stable for at least thirty minutes if the sample cell is kept tightly capped and out of direct sunlight.



15. Blank Preparation: Fill another 25-mL square sample cell with chloroform. Stopper.



16. Insert the blank into the cell holder with the fill line facing right.



17. Press **ZERO**.
The display will show:
0 µg/L Pb²⁺

18. Insert the prepared sample into the cell holder with the fill line facing right.

19. Press **READ**.
Results are in µg/L Pb²⁺.

Interferences

Table 1 Interfering Substances and Levels

Interfering Substance	Interference Levels and Treatments
Highly buffered samples or extreme sample pH	All levels. See procedure below.
Bismuth	All levels. See procedure below.
Copper	All levels. See procedure below.
Mercury	All levels. See procedure below.
Silver	All levels. See procedure below.
Tin	All levels. See procedure below.

Table 2 Substances That Do Not Interfere

Aluminum	Lead
Antimony	Magnesium
Arsenic	Manganese
Calcium	Nickel
Chromium	Tin
Cobalt	Zinc
Iron	

Eliminate interference from the metals in [Table 1](#) by the following treatment, beginning after step 6.

1. Measure about 5-mL of the DithiVer solution into the separatory funnel. Stopper the funnel, invert and open the stopcock to vent. Close the stopcock and shake the solution vigorously for 15 seconds. Allow the funnel to stand undisturbed until the layers separate (about 30 seconds). A yellow, red, or bronze color in the bottom (chloroform) layer confirms the presence of interfering metals. Draw off and collect the bottom (chloroform) layer for proper disposal.

2. Repeat extraction with fresh 5-mL portions of prepared dithizone solution (collecting the bottom layer each time in appropriate waste collection vessel) until the bottom layer shows a pure dark green color for three successive extracts. Extractions can be repeated a number of times without appreciably affecting the amount of lead in the sample.
3. Extract the solution with several 2 or 3 mL portions of pure chloroform to remove any remaining dithizone, again collecting the bottom layer each time for proper disposal.
4. Continue the procedure, substituting 28.5 mL of prepared dithizone solution for the 30 mL in step 7.

DithiVer Solution Preparation, Storage, and Reagent Blank

Store DithiVer Powder Pillows away from light and heat. A convenient way to prepare this solution is to add the contents of 10 DithiVer Metals Reagent Powder Pillows to a 500-mL bottle of chloroform and invert several times until well mixed (carrier powder may not dissolve). Store dithizone solution in an amber glass bottle. This solution is stable for 24 hours.

A reagent blank using deionized water should be carried out through the entire method to obtain the most accurate results.

Sample Collection, Preservation, and Storage

Collect samples in an acid-washed glass or plastic containers. Adjust the pH to 2 or less with nitric acid (about 2 mL per liter). Store preserved samples up to six months at room temperature. Adjust the pH to 2.5 with 5.0 N sodium hydroxide before analysis. Correct the test result for volume additions.

Accuracy Check

1. Leave the unspiked sample in the sample cell compartment. Verify that the units displayed are in µg/L.
2. Press **OPTIONS>MORE**. Press **STANDARD ADDITIONS**. A summary of the standard additions procedure will appear.
3. Press **OK** to accept the default values for standard concentration, sample volume, and spike volumes. Press **EDIT** to change these values. After values are accepted, the unspiked sample reading will appear in top row. See the user manual for more information.
4. Snap the neck off a Lead Voluette Ampule Standard, 50-mg/L Pb.
5. Use the TenSette® Pipet (do not use a glass pipet) to add 0.1 mL, 0.2 mL, and 0.3 mL of standard, respectively to three 250-mL samples and mix each thoroughly.
6. Analyze each standard addition sample as described above. Accept the standard additions reading by pressing the soft key under **READ** each time. Each addition should reflect approximately 100% recovery.
7. After completing the sequence, press **GRAPH** to view the best-fit line through the standard additions data points, accounting for the matrix interferences. Press **IDEAL LINE** to view the relationship between the sample spikes and the "Ideal Line" of 100% recovery.

Standard Solution Method

1. Prepare a 10-mg/L lead standard solution by pipetting 10.00 mL of Lead Standard Solution, 100-mg/L, into a 100-mL volumetric flask.
2. Add 0.2 mL of concentrated nitric acid using a TenSette Pipet to prevent the adsorption of lead onto the container walls. Dilute to the mark with deionized water and mix thoroughly.
3. To make a 200-µg/L standard, pipet 5.00 mL of the 10.0-mg/L standard into 245 mL of deionized water in the 500-mL separatory funnel in step 4 of the Dithizone procedure. Prepare these solutions daily. Perform the lead procedure as described above.
4. To adjust the calibration curve using the reading obtained with the standard solution, press **OPTIONS>MORE** on the current program menu. Press **STANDARD ADJUST**.
5. Press **ON**. Press **ADJUST** to accept the displayed concentration. If an alternate concentration is used, press the number in the box to enter the actual concentration, then press **OK**. Press **ADJUST**.

Summary of Method

The dithizone method is designed for the determination of lead in water and wastewater. The DithiVer Metals Reagent is a stable powder form of dithizone. Lead ions in basic solution react with dithizone to form a pink to red lead-dithizonate complex, which is extracted with chloroform. Test results are measured at 515 nm.

Consumables and Replacement Items

Required Reagents

Description	Quantity/Test	Unit	Cat. No.
Lead Reagent Set (100 Tests) Includes: (1) 14202-99, (2) 14458-17, (1) 12616-99, (2) 767-14, (1) 2450-53, (2) 2450-26	—	—	22431-00
Buffer Powder Pillows, citrate	1	100/pkg	14202-99
Chloroform, ACS	30 mL	4 L	14458-17
DithiVer Metals Reagent Powder Pillows	1	100/pkg	12616-99
Potassium Cyanide	0.1 g	125 g	767-14
Sodium Hydroxide Solution, 5.0 N	5 mL	1000 mL	2450-53
Sodium Hydroxide Standard Solution, 5.0 N	varies	59 mL DB	2450-26

Required Apparatus

Description	Quantity/Test	Unit	Cat. No.
Clippers, for opening powder pillows	1	each	968-00
Cotton Balls, absorbent	1	100/pkg	2572-01
Cylinder, graduated, 5-mL	1	each	508-37
Cylinder, graduated, 50-mL	1	each	508-41
Cylinder, graduated, 250-mL	1	each	508-46
Cylinder, graduated, mixing, 50-mL	1	each	1896-41
Funnel, separatory, 500-mL	1	each	520-49
pH Meter, sens <i>ion</i> ™1, portable, with electrode	1	each	51700-10
Sample Cell, 1-inch square, 25 mL with cap	2	2/pkg	26126-02

Required Apparatus (continued)

Description	Quantity/Test	Unit	Cat. No.
Spoon, measuring, 1-g	1	each	510-00
Support Ring, 4"	1	each	580-01
Support Ring Stand, 5" x 8" base	1	each	563-00

Recommended Standards

Description	Unit	Cat. No.
Lead Standard Solution, 100 mg/L Pb	100 mL	12617-42
Lead Standard Solution, 10-mL Voluette Ampules, 50-mg/L Pb	16/pkg	14262-10

Optional Reagents and Apparatus

Description	Unit	Cat. No.
Ampule Breaker Kit	each	21968-00
Chloroform, ACS	500 mL	14458-49
Filter Discs, glass, 47 mm	100/pkg	2530-00
Filter Holder, glass, for 47-mm filter	each	2340-00
Flask, Erlenmeyer, 500-mL	each	505-49
Flask, filtering, 500-mL	each	546-49
Flask, volumetric, Class A, 100-mL	each	14574-42
Nitric Acid Solution, 1:1	500 mL	2540-49
Nitric Acid, ACS	500 mL	152-49
pH Paper, pH 1.0 to 11.0	5 rolls/pkg	391-33
Pipet, serological, 2-mL	each	532-36
Pipet, TenSette®, 0.1 to 1.0 mL	each	19700-01
Pipet Tips, for TenSette Pipet 19700-01	50/pkg	21856-96
Pipet, volumetric, 5.00-mL, Class A	each	14515-37
Pipet, volumetric, 10.00-mL, Class A	each	14515-38
Pipet Filler, safety bulb	each	14651-00
Sulfuric Acid, 5.25 N	100 mL MDB	2449-32
Water, deionized	4 liters	272-56



FOR TECHNICAL ASSISTANCE, PRICE INFORMATION AND ORDERING:

In the U.S.A. – Call toll-free 800-227-4224
Outside the U.S.A. – Contact the HACH office or distributor serving you.
On the Worldwide Web – www.hach.com; E-mail – techhelp@hach.com

HACH COMPANY
WORLD HEADQUARTERS
Telephone: (970) 669-3050
FAX: (970) 669-2932

Method 10216

PAR Method

TNTplus™ 850

(0.1 to 2.0 mg/L Pb)

Scope and Application: For wastewater and process control



Test Preparation

Before starting the test:

Important Note: Install the light shield in Cell Compartment #2 before performing this test.

Please read Safety Advice and Expiration Date on package.

Recommended sample pH is 3–9.

Recommended sample and reagent temperature is 15–25 °C (59–77 °F).

Recommended reagent storage is 15–25 °C (59–77 °F).

Samples which are free from complexing agents and have a pH between 3 and 6 can be analyzed directly.

Samples with a pH between 6 and 9 must be additionally digested with Metals Prep Set TNT 890 in order to bring undissolved lead hydroxide or complex lead compounds into solution.

TNTplus methods are activated directly from the Main Menu when the sample vial is inserted into the sample cell holder.

Collect the following items:

Quantity

Lead TNT850 Reagent Set	1
Light Shield	1
Pipettor, variable 1–5 mL	1
Pipettor tips for 1–5 mL pipettor	1
Pipet, volumetric 10 mL	1
Safety pipet bulb	1
Pipettor, variable 100–1000µL	1
Pipettor Tips for 100–1000 µL pipettor	1

Note: Reorder information for consumables and replacement items is on page 4.

TNTplus

Method 10216

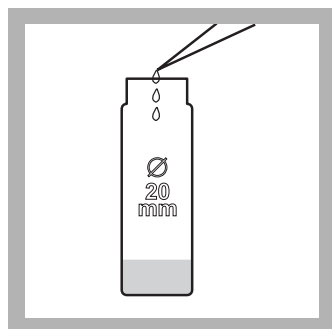

1. Pipet 10 mL of sample into the 20-mm reaction tube.

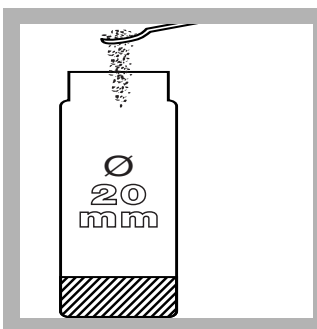

2. Add 1 level spoonful of Reagent A to the reaction tube.

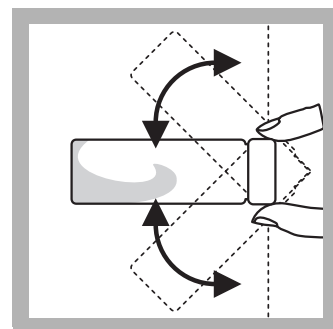

3. Cap the reaction tube and invert 2–3 times.



4. Wait two minutes.

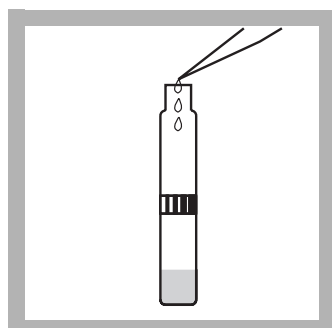

5. When the timer expires, add 1.5 mL of Solution B into a sample vial.

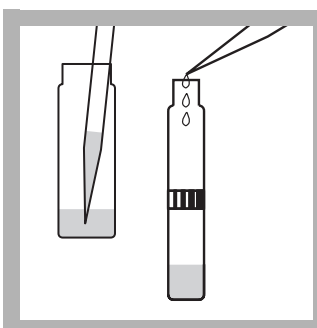

6. Pipet 4.0 mL of the pretreated sample from the 20 mm reaction tube prepared in step 3 into the vial.

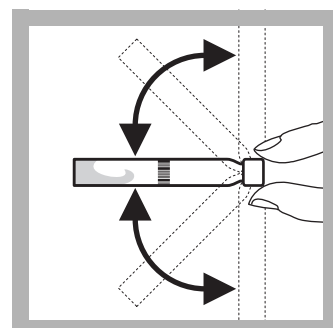

7. Cap and invert the vial 2-3 times.



8. Wait two minutes.

Install the Light Shield in Cell Compartment #2.

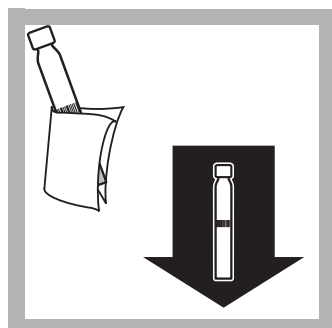

9. Thoroughly clean the outside of the vial and insert it into the sample cell holder. The instrument reads the barcode, then selects the method and sets the blank.

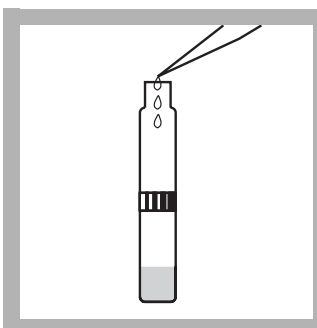

10. Remove the vial and add 0.3 mL (300 µL) of Solution C into the vial.

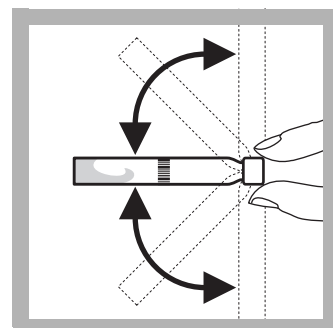

11. Cap the vial and invert the vial 2–3 times

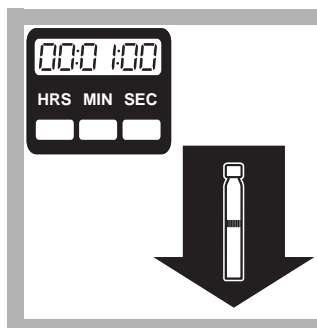

12. Wait one minute, then insert the prepared vial into the cell holder. The instrument reads the barcode, then reads the sample. Results are in mg/L lead.

Reagent Blank

A reagent blank can be measured, and the value subtracted from the results of each test performed using the same reagent lot number. Use deionized water in place of sample and run the procedure as described.

To subtract the value of the blank from a series of measurements, measure the blank per step 12. Press **OPTIONS>MORE>REAGENT BLANK**. Press **ON**. The measured value of the blank should be displayed in the highlighted box. Press **OK** to accept this value. The reagent blank value will now be subtracted from all results until the function is turned off, or a different method is selected. Alternately, the blank can be recorded and entered at any later time by pressing the highlighted box and using the keypad to enter the value.

Interferences

The ions listed in Table 1 have been individually checked up to the given concentrations and do not cause interference. Cumulative effects and the influence of other ions have not been determined.

Measurement results can be verified using sample dilutions or standard additions.

Table 1 Interfering Substances and Levels

Interfering Substances	Interference Levels
K ⁺ , Na ⁺ , Ca ²⁺ , Mg ²⁺ , NO ₃ ⁻ , Cl ⁻ , PO ₄ ³⁻ , CO ₃ ²⁻ , SO ₄ ²⁻	500 mg/L
F ⁻ , NH ₄ ⁺ , Sr ²⁺	50 mg/L
Ag ⁺ , Cd ²⁺ , Cr ⁶⁺ , Zn ²⁺ , Cu ²⁺ , Co ²⁺ , Ni ²⁺	25 mg/L
Cr ³⁺ , Al ³⁺ , Fe ²⁺ , Fe ³⁺	10 mg/L
Mn ²⁺ , Hg ²⁺	5 mg/L
Sn ²⁺	0.5 mg/L

Sample Collection, Preservation, and Storage

Collect samples in an acid-washed glass or plastic containers. Adjust the pH to 2 or less with nitric acid (about 2 mL per liter). Store preserved samples up to six months at room temperature. Adjust the pH to between 3 and 6 with 5.0 N sodium hydroxide before analysis. Correct the test result for volume additions.

Accuracy Check

Standard Solution Method

1. Prepare a 1.0 mg/L lead standard solution by pipetting 1.0 mL of a 100 mg/L lead standard solution into a 100 mL volumetric flask.
2. Dilute to volume with deionized water. Use 10 mL of this standard in place of the sample in the procedure.

Summary of Method

Lead (II) ions react at pH 9 with 4-(2-pyridylazo)-resorcinol (PAR) to form a red complex. Test results are measured at 520 nm.

Consumables and Replacement Items

Required Reagents

Description	Quantity/Test	Unit	Cat. No.
Lead TNT 850 Reagent Set	1	25/pkg	TNT850

Required Apparatus

Description	Quantity/Test	Unit	Cat. No.
Light Shield	1	each	LZV646
Pipet, variable volume, 1-5 mL	1	each	27951-00
Pipet Tips, for 27951-00 pipet	1	100/pkg	27952-00
Pipet, Volumetric 10 mL	1	each	14515-38
Pipet Filler, safety bulb	1	each	14651-00
Pipet, variable volume, 100–1000 µL	1	each	27949-00
Pipet Tips, for 27949-00 pipet	1	400/pkg	27950-00

Recommended Reagents and Standards

Description	Unit	Cat. No.
Lead Standard Solution, 100 mg/L	100 mL	12617-42
Nitric Acid, ACS	500 mL	152-49
Sodium Hydroxide Standard Solution, 5.0 N	100 mL MDB	2450-32
Sodium Hydroxide Standard Solution, 5.0 N	59 mL SCDB	2450-26
Water, deionized	4 L	272-56

Optional Reagents and Apparatus

Description	Unit	Cat. No.
Bottle, sampling, low density poly, w/cap, 500 mL	12/pk	20870-79
Flask, volumetric 100 mL	each	14574-42
Metals Prep Set TNT 890	each	TNT890
Pipet, volumetric 1.0 mL	each	14515-35
Test Tube Rack for 13-mm vials	each	24979-00



FOR TECHNICAL ASSISTANCE, PRICE INFORMATION AND ORDERING:
 In the U.S.A. – Call toll-free 800-227-4224
 Outside the U.S.A. – Contact the HACH office or distributor serving you.
 On the Worldwide Web – www.hach.com; E-mail – techhelp@hach.com

HACH COMPANY
 WORLD HEADQUARTERS
 Telephone: (970) 669-3050
 FAX: (970) 669-2932

Manganese

Method 8149

1-(2-Pyridylazo)-2-Naphthol PAN Method¹

Powder Pillows

LR (0.006 to 0.700 mg/L)

Scope and Application: For water and wastewater; digestion is required for determining total manganese

¹ Adapted from Goto, K., et al., *Talanta*, 24, 652-3 (1977)



Test Preparation

Before starting the test:

Rinse all glassware with 1:1 Nitric Acid Solution. Rinse again with deionized water.

The alkaline cyanide solution contains cyanide. Cyanide solutions should be collected for disposal as a reactive (D001) waste. Be sure cyanide solutions are stored in a caustic solution with pH >11 to prevent release of hydrogen cyanide gas. Refer to the current MSDS for safe handling and disposal instructions.

Collect the following items:

Quantity

Alkaline Cyanide Reagent	12 drops
Ascorbic Acid Powder Pillows	2
PAN Indicator Solution, 0.1%	12 drops
Deionized Water	10 mL
Sample Cells, 1-inch square, 10-mL	2
Stoppers for 18 mm tube	2

Note: Reorder information for consumables and replacement items is on page 4.

Powder Pillows

Method 8149

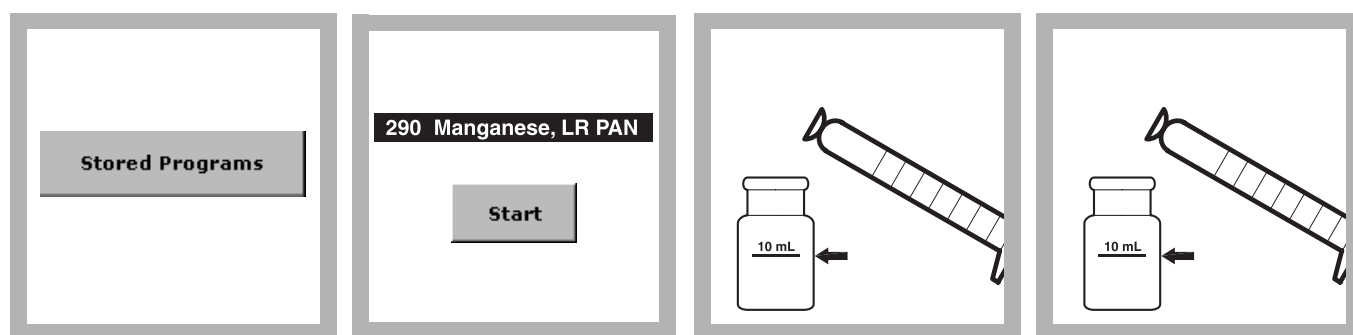

1. Press **STORED PROGRAMS**.

2. Select the test.

3. **Blank Preparation:**
Pour 10.0 mL of deionized water into a square sample cell.

4. **Prepared Sample:**
Pour 10.0 mL of sample into another square sample cell.

Manganese LR (0.006 to 0.700 mg/L)

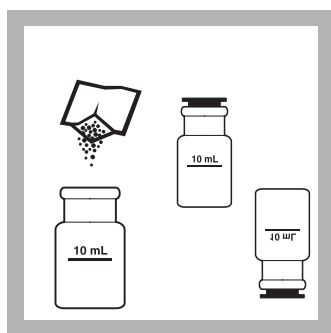

5. Add the contents of one Ascorbic Acid Powder Pillow to each cell. Stopper and invert to dissolve the powder.

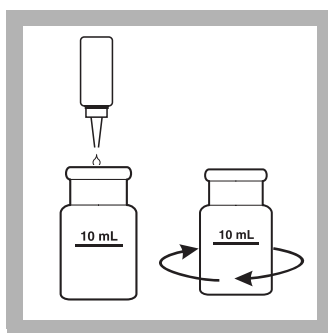

6. Add 12 drops of Alkaline-Cyanide Reagent Solution to each cell. Swirl gently to mix.

A cloudy solution may form. The turbidity should dissipate after step 7.

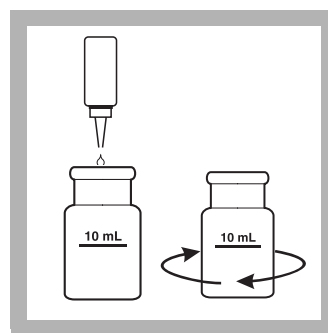

7. Add 12 drops of PAN Indicator Solution, 0.1%, to each sample cell. Swirl gently to mix.

An orange color will develop in the sample if manganese is present.

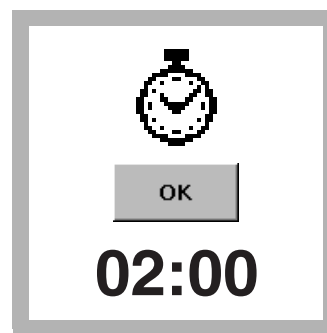

8. Press **TIMER>OK**.

A two-minute reaction period will begin.



9. When the timer expires, wipe the blank and insert it into the cell holder with the fill line facing right.

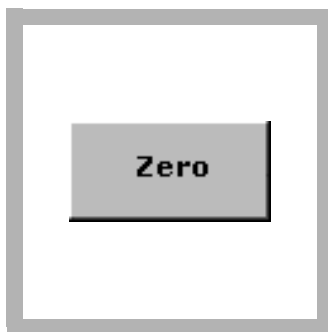

10. Press **ZERO**.

The display will show:
0.000 mg/L Mn



11. Wipe the prepared sample and insert it into the cell holder with the fill line facing right.

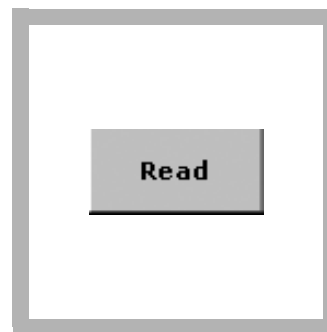

12. Press **READ**.

Results are in mg/L Mn.

Interferences

Table 1 Interfering Substances and Levels

Interfering Substance	Interference Levels and Treatments
Aluminum	20 mg/L
Cadmium	10 mg/L
Calcium	1000 mg/L as CaCO ₃
Cobalt	20 mg/L
Copper	50 mg/L
Iron	25 mg/L (If sample contains more than 5 mg/L iron, allow a 10-minute reaction period in step 8.)
Lead	0.5 mg/L
Magnesium	300 mg/L as CaCO ₃
Nickel	40 mg/L
Zinc	15 mg/L

For samples that contain hardness greater than 300 mg/L CaCO₃, add 10 drops of Rochelle Salt Solution* to the sample **after** adding the Ascorbic Acid Powder Pillow in step 5.

Sample Collection, Storage, and Preservation

Collect samples in a clean plastic container. Adjust the pH to 2 or less with Concentrated Nitric Acid* (about 2 mL per liter). Preserved samples can be stored up to six months at room temperature. Adjust the pH to between 4–5 with 5.0 N Sodium Hydroxide* before analysis. Correct the test result for volume additions.

Accuracy Check

Standard Additions Method (Sample Spike)

1. After reading test results, leave the sample cell (unspiked sample) in the instrument. Verify the chemical form.
2. Press **OPTIONS>MORE**. Press **STANDARD ADDITIONS**. A summary of the standard additions procedure will appear.
3. Press **OK** to accept the default values for standard concentration, sample volume, and spike volumes. Press **EDIT** to change these values. After values are accepted, the unspiked sample reading will appear in the top row. See the user manual for more information.
4. Snap the neck off a Manganese Voluette® Ampule Standard, 10-mg/L Mn.
5. Prepare three sample spikes. Fill three Mixing Cylinders* with 10 mL of sample. Use the TenSette® Pipet* to add 0.1 mL, 0.2 mL, and 0.3 mL of standard, respectively, to each sample and mix thoroughly.
6. Analyze each sample spike as described in the procedure above, starting with the 0.1 mL sample spike. Accept each standard additions reading by pressing **READ**. Each addition should reflect approximately 100% recovery.
7. After completing the sequence, press **GRAPH** to view the best-fit line through the standard additions data points, accounting for the matrix interferences. Press **IDEAL LINE** to view the relationship between the sample spikes and the “Ideal Line” of 100% recovery.

Standard Solution Method

1. Prepare a 0.5-mg/L manganese standard solution by pipetting 2.0 mL of Manganese Voluette Standard Solution, 250-mg/L Mn, into a 1000-mL volumetric flask. Dilute to the mark with deionized water. This solution should be prepared daily. Perform the manganese procedure as described above.
2. To adjust the calibration curve using the reading obtained with the standard solution, press **OPTIONS>MORE** on the current program menu. Press **STANDARD ADJUST**.
3. Press **ON**. Press **ADJUST** to accept the displayed concentration. If an alternate concentration is used, press the number in the box to enter the actual concentration, then press **OK**. Press **ADJUST**.

* See [Optional Reagents and Apparatus on page 4](#).

Summary of Method

The PAN method is a highly sensitive and rapid procedure for detecting low levels of manganese. An ascorbic acid reagent is used initially to reduce all oxidized forms of manganese to Mn^{2+} . An alkaline-cyanide reagent is added to mask any potential interferences. PAN Indicator is then added to combine with the Mn^{2+} to form an orange-colored complex. Test results are measured at 560 nm.

Consumables and Replacement Items

Required Reagents

Description	Quantity/Test	Unit	Cat. No.
Manganese Reagent Set, 10-mL (50 tests), includes:	—	—	26517-00
Alkaline Cyanide Reagent	12 drops	50mL SCDB	21223-26
Ascorbic Acid Powder Pillows	2 pillows	100/pkg	14577-99
PAN Indicator Solution, 0.1%	12 drops	50 mL SCDB	21224-26
Water, deionized	10 mL	4 L	272-56

Required Apparatus

Description	Quantity/Test	Unit	Cat. No.
Sample Cells, 1-inch square, 10 mL, matched pair	2	2/pkg	24954-02
Stoppers for 18 mm Tube	2	6/pkg	1731-06

Recommended Standards

Description	Unit	Cat. No.
Manganese Standard Solution, 10-mg/L Mn, 2-mL ampule	20/pkg	26058-20
Manganese Standard Solution, 250-mg/L Mn, 10-mL Voluette® ampule	16/pkg	14258-10

Optional Reagents and Apparatus

Description	Unit	Cat. No.
Cylinder, mixing, 25 mL	each	20886-40
Nitric Acid, concentrated, 500 mL	—	152-49
Pipet, TenSette® 0.1–1.0 mL	each	19700-01
Pipet Tips, for TenSette Pipet 19700-01	50/pkg	21856-96
Rochelle Salt Solution, 29 mL	—	1725-33
Sodium Hydroxide, 5.0 N, 100 mL	—	2450-32
Stopper for 18 mm tube	25/pkg	1731-25



FOR TECHNICAL ASSISTANCE, PRICE INFORMATION AND ORDERING:
In the U.S.A. – Call toll-free 800-227-4224
Outside the U.S.A. – Contact the HACH office or distributor serving you.
On the Worldwide Web – www.hach.com; E-mail – techhelp@hach.com

HACH COMPANY
WORLD HEADQUARTERS
Telephone: (970) 669-3050
FAX: (970) 669-2932

Manganese

★Method 8034

Periodate Oxidation Method¹

Powder Pillows

HR (0.1 to 20.0 mg/L)

Scope and Application: For soluble manganese in water and wastewater; USEPA approved for reporting wastewater analyses (digestion required)².

¹ Adapted from *Standard Methods for the Examination of Water and Wastewater*

² *Federal Register*, 44(116) 34193 (June 14, 1979)



Test Preparation

Before starting the test:

Digestion is required for reporting wastewater analyses.

If only dissolved manganese is to be determined, filter the sample before acid addition.

For more accurate results, determine a reagent blank value for each new lot of reagent. Follow the procedure using deionized water in place of the sample. Subtract the reagent blank value from the final results or perform a reagent blank adjust.

Collect the following items:

Quantity

High Range Manganese Reagent Set

1

Sample Cells, 1-inch square, 10-mL

2

Note: Reorder information for consumables and replacement items is on page 4.

Powder Pillows

Method 8034



1. Press
STORED PROGRAMS.



2. Select the test.

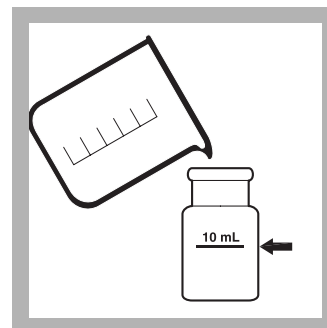

3. **Prepared Sample:**
Fill a square sample cell
with 10 mL of sample.

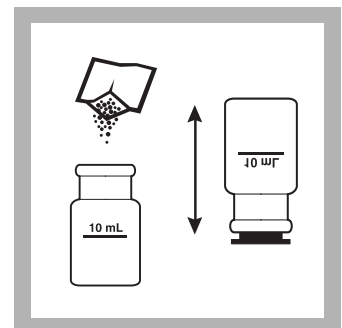

4. Add the contents of
one Buffer Powder Pillow,
Citrate Type for
Manganese. Stopper and
invert to mix.

Manganese HR (0.1 to 20.0 mg/L)

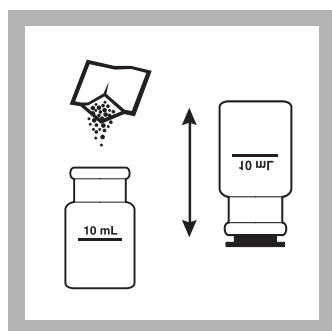

5. Add the contents of one Sodium Periodate Powder Pillow to the sample cell. Stopper and invert to mix.

A violet color will develop if manganese is present.



6. Press **TIMER>OK**.
A two-minute reaction period will begin.

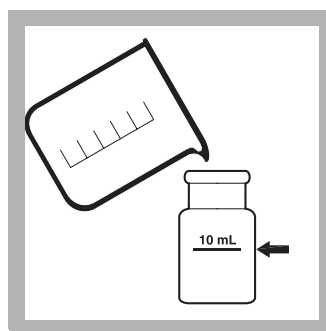

7. **Blank Preparation:**
Fill a second square sample cell with 10 mL of sample.



8. When the timer expires, insert the blank into the cell holder with the fill line facing right.

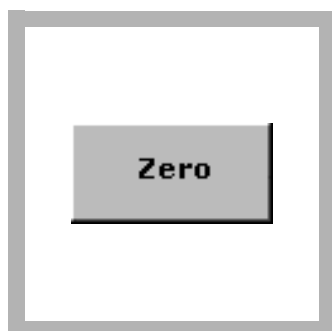

9. Press **ZERO**.
The display will show:
0.0 mg/L Mn



10. Within eight minutes after the timer expires, insert the sample into the cell holder with the fill line facing right.

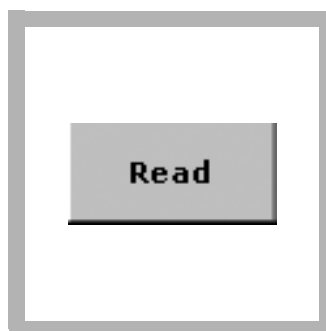

11. Press **READ**.
Results are in mg/L Mn.

Interferences

Table 1 Interfering Substances and Levels

Interfering Substance	Interference Levels and Treatments
Calcium	700 mg/L
Chloride	70,000 mg/L
Iron	5 mg/L
Magnesium	100,000 mg/L
pH	Highly buffered samples or extreme sample pH may exceed the buffering capacity of the reagents and require sample pretreatment.

Sample Collection, Storage, and Preservation

Collect samples in acid-washed plastic bottles. Do not use glass containers due to possible adsorption of Mn to glass. If samples are acidified, adjust the pH to 4–5 with 5.0 N Sodium Hydroxide* before analysis. Do not exceed pH 5, as manganese may precipitate. Correct the test result for volume additions.

Accuracy Check

Standard Additions Method (Sample Spike)

1. After reading test results, leave the sample cell (unspiked sample) in the instrument. Verify the chemical form.
2. Press **OPTIONS**. Press **STANDARD ADDITIONS**. A summary of the standard additions procedure will appear.
3. Press **OK** to accept the default values for standard concentration, sample volume, and spike volumes. Press **EDIT** to change these values. After values are accepted, the unspiked sample reading will appear in the top row. See the user manual for more information.
4. Snap the neck off a Manganese Voluette® Ampule Standard, 250-mg/L Mn*.
5. Prepare three sample spikes. Fill three sample cells with 10 mL of sample. Use the TenSette® Pipet* to add 0.1 mL, 0.2 mL, and 0.3 mL of standard, respectively, to each sample and mix thoroughly.
6. Analyze each sample spike as described in the procedure above, starting with the 0.1 mL sample spike. Accept each standard additions reading by pressing **READ**. Each addition should reflect approximately 100% recovery.
7. After completing the sequence, press **GRAPH** to view the best-fit line through the standard additions data points, accounting for the matrix interferences. Press **IDEAL LINE** to view the relationship between the sample spikes and the “Ideal Line” of 100% recovery.

Standard Solution Method

1. Prepare a 10.0-mg/L manganese standard solution by pipetting 10.0 mL of Manganese Standard Solution, 1000-mg/L, into a 1000-mL volumetric flask. Dilute to the mark with deionized water. Prepare this solution daily. Perform the manganese periodate oxidation procedure as described above.
2. To adjust the calibration curve using the reading obtained with the standard solution, press **OPTIONS>MORE** on the current program menu. Press **STANDARD ADJUST**.
3. Press **ON**. Press **ADJUST** to accept the displayed concentration. If an alternate concentration is used, press the number in the box to enter the actual concentration, then press **OK**. Press **ADJUST**.

* See [Optional Reagents and Apparatus on page 4](#).

Summary of Method

Manganese in the sample is oxidized to the purple permanganate state by sodium periodate, after buffering the sample with citrate. The purple color is directly proportional to the manganese concentration. Test results are measured at 525 nm.

Consumables and Replacement Items

Required Reagents

Description	Quantity/Test	Unit	Cat. No.
Manganese Reagent Set, High Range (100 tests), includes:	—	—	24300-00
Buffer Powder Pillows, citrate type for Manganese	1	100/pkg	21076-69
Sodium Periodate Powder Pillows for Manganese	1	100/pkg	21077-69

Required Apparatus

Description	Quantity/Test	Unit	Cat. No.
Sample Cells, 1-inch square, 10 mL, matched pair	2	2/pkg	24954-02
Stopper, rubber	1	6/pkg	1731-06

Recommended Standards

Description	Unit	Cat. No.
Manganese Standard Solution, 1000-mg/L Mn,	100 mL	12791-42
Manganese Standard Solution, 250-mg/L Mn, 10-mL Voluette® ampule	16/pkg	14258-10
Water, deionized	4 L	272-56

Optional Reagents and Apparatus

Description	Cat. No.
Manganese Voluette® Ampule Standard, 250-mg/L	14258-10
Pipet, TenSette®, 0.1–1.0 mL	19700-01
Pipet Tips, for TenSette Pipet 19700-01	21856-96
Sodium Hydroxide, 5.0 N, 100 mL	2450-32



FOR TECHNICAL ASSISTANCE, PRICE INFORMATION AND ORDERING:
In the U.S.A. – Call toll-free 800-227-4224
Outside the U.S.A. – Contact the HACH office or distributor serving you.
On the Worldwide Web – www.hach.com; E-mail – techhelp@hach.com

HACH COMPANY
WORLD HEADQUARTERS
Telephone: (970) 669-3050
FAX: (970) 669-2932

Scope and Application: For water, wastewater, and seawater

¹ Patent no. 5,733,786



Test Preparation

Before starting the test:

Perform phase 1 of the procedure in a fume hood. Toxic chlorine or other gases may be produced.

Use dedicated digestion glassware and sample cells for this procedure.

Determine a reagent blank for each new lot of reagent by running the entire procedure, including the digestion, using one liter of deionized water instead of sample. Add the same amount of potassium permanganate as required by the sample. Subtract the reagent blank value from the final results or perform a reagent blank adjust.

Collect the following items:

Quantity

Cold Vapor Mercury Reagent Set (see Required Reagents on page 10 for contents of reagent set)	1
Digestion Reagents and Apparatus (see Required Digestion Reagents and Apparatus on page 11)	varies
Cold Vapor Mercury Apparatus Set	1
Sample Cells, 1-inch square, 10-mL, matched pair	2

See [Required Apparatus on page 10](#) for a complete list of required apparatus.

Note: Reorder information for consumables and replacement items is on [page 10](#).

Phase 1: Sample Digestion

DANGER

Test must be performed under a fume hood – toxic gases may be produced!



1. Transfer one liter of the sample to a 2000-mL Erlenmeyer flask. Add a 50-mm magnetic stir bar to the sample. Set the flask on a magnetic stirring hot plate and begin stirring.

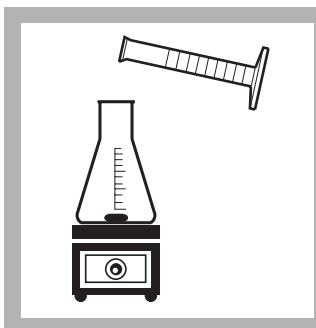

2. Add 50 mL of concentrated sulfuric acid to the sample.

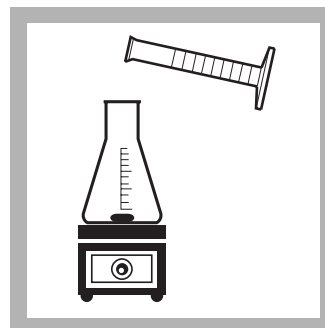

3. Add 25 mL of concentrated nitric acid to the sample.

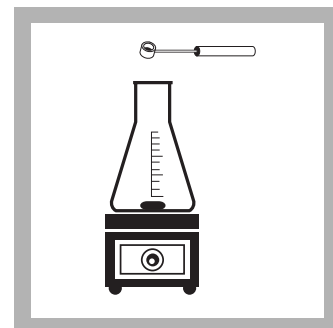

4. Add 4.0 g of potassium persulfate to the sample. Stir until dissolved.

Alternatively, add one 5-gram measuring scoop of potassium persulfate to the sample.

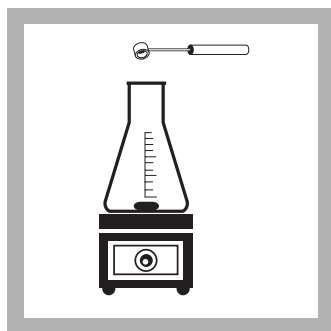

5. Add 7.5 g of potassium permanganate to the sample. Stir until dissolved.

Alternatively, add a 10-gram measuring scoop of potassium permanganate to the sample.



6. Cover the flask with a watch glass. Begin heating the sample to a temperature of 90 °C after the reagents have dissolved. **Do not boil.**

For a mercury standard or reagent blank in distilled water, the heat step is not necessary.

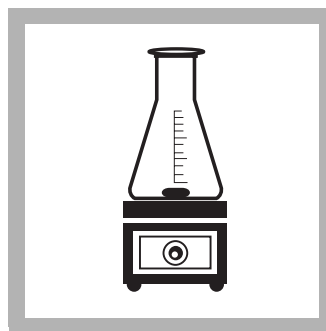

7. Continue to stir and heat the sample at 90 °C for two hours.

The solution must remain dark purple throughout the entire digestion. Some samples, such as sea waters, industrial effluents or other samples high in organic matter or chloride concentration, require additional permanganate. It may be difficult to see a dark purple color if the sample contains black/brown manganese dioxide precipitate. Add more potassium permanganate if the solution is not dark purple.



8. Cool the digested sample to room temperature.

A brown/black precipitate of manganese dioxide may settle during cooling. If the digested sample does not have a purple color, the digestion may be incomplete. Add more potassium permanganate. Return the sample to the magnetic stirring hot plate and continue the digestion until the purple color persists.

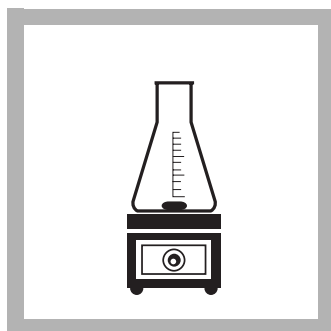

9. Return the cool, digested sample to the cool, magnetic stirring hot plate. Turn on the stirrer.



10. Using a 0.5-g measuring spoon, add 0.5 g additions of hydroxylamine-hydrochloride until the purple color disappears. Wait 30 seconds after each addition to see if the purple disappears. Add hydroxylamine-hydrochloride until all manganese dioxide is dissolved.

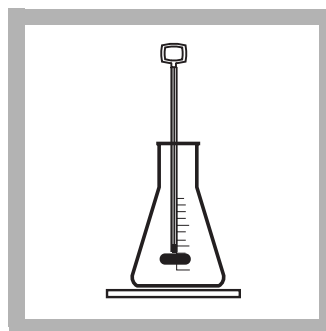

11. Remove the stir bar.



12. The digested sample is now ready for processing by cold vapor separation and preconcentration. Proceed to Phase 2.

Phase 2: Cold Vapor Separation and Preconcentration of Mercury

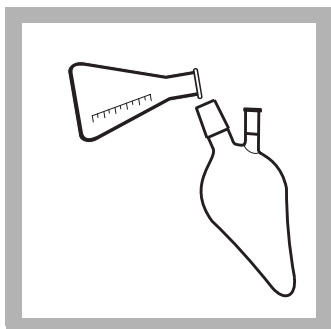

1. Transfer the digested sample to the Cold Vapor Gas Washing Bottle. (The volume of the digested sample should contain 0.1 to 2.5 µg Hg.)

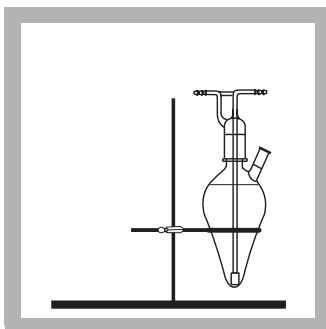

2. Set the Gas Washing Bottle in the support ring. Place the top on the Gas Washing Bottle. Wait until step 9 to connect the mercury absorber column to the Gas Washing Bottle.

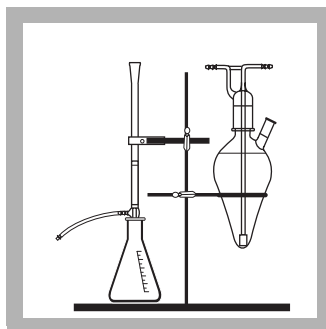

3. Connect the 100-mL Erlenmeyer flask to the mercury absorber column.

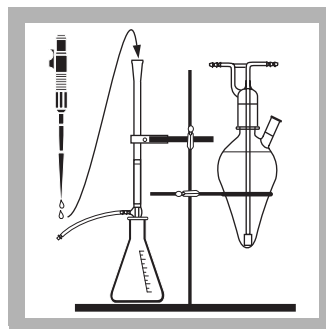

4. Pipet 8 mL of HgEx Reagent B into the Mercury Absorber column.

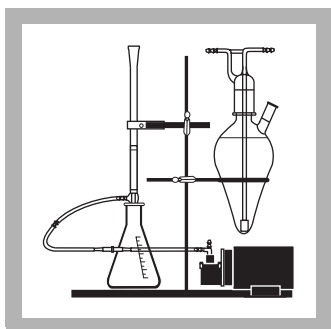

5. Connect the power to the vacuum pump and apply vacuum to the Mercury Absorber Column. Draw most of the HgEx Reagent B into the Erlenmeyer flask.

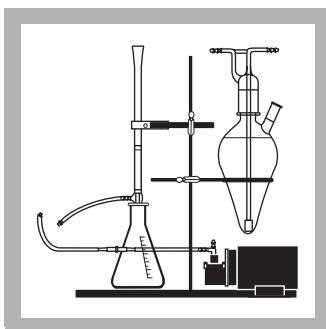

6. Disconnect the vacuum using the quick disconnect when HgEx Reagent B begins to drip from the inner delivery tube on the Mercury Absorber Column (about 10 seconds after starting the vacuum). Do not draw enough air through the column to begin drying the packing.

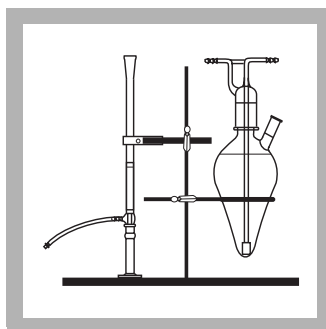

7. Remove the 100-mL Erlenmeyer flask from the Mercury Absorber Column. Replace it with the 10-mL Distilling Receiver.

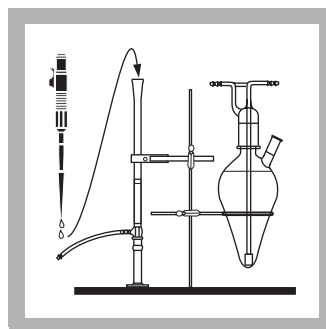

8. Pipet 2 mL of HgEx Reagent C into the Mercury Absorber Column.

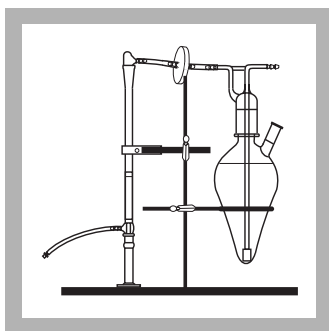

9. Connect the Mercury Absorber column to the Gas Washing Bottle using the glass elbow.

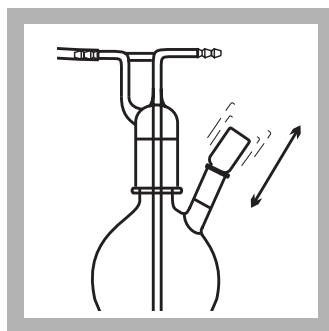

10. Shake an ampule of HgEx Reagent A to suspend undissolved reagent.

Open the ampule and gently shake the contents into the Gas Washing Bottle through the side neck.

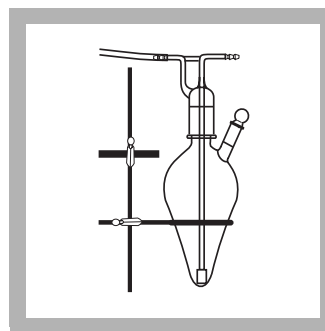

11. Stopper the side neck on the Glass Washing Bottle.

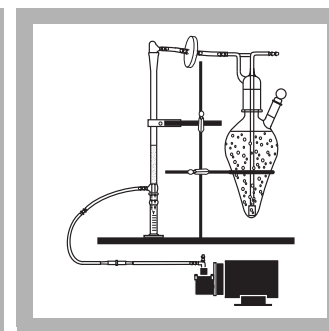

12. Reconnect the vacuum to the Mercury Absorber Column using the quick disconnect. The vacuum will pull HgEx Reagent C through the Mercury Absorber Column packing and into the 10-mL receiver. Air bubbles should be produced at the gas dispersion tube in the Gas Washing Bottle. Perform steps 13–14 immediately.

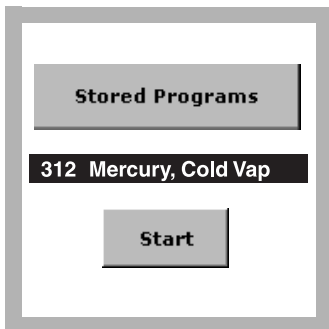

13. Select the test.



14. Press **TIMER>OK**.

A five-minute reaction period will begin. Let the solution bubble for this period.

Air flow rate through the Gas Washing Bottle should be between 1–5 L/min. Allow more bubbling time for lower air flow rates. For example, if the air flow rate is 1 L/min., let the solution bubble for 10 minutes.

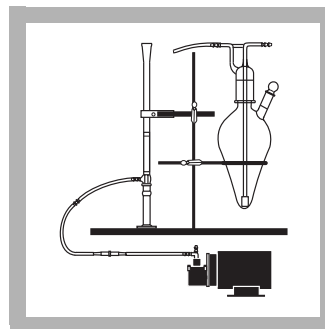

15. After the timer expires, remove the glass elbow from the top of the Mercury Absorber Column. Keep the vacuum pump on.

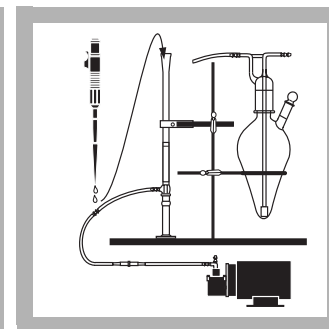

16. Pipet 8 mL of HgEx Reagent B into the Mercury Absorber Column to elute the captured mercury.

Continue to apply vacuum to pull the HgEx Reagent B into the Distilling Receiver.

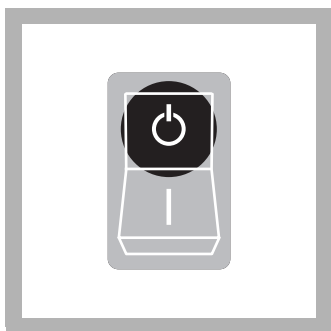

17. Turn off or disconnect power to the vacuum pump when the volume in the Distilling Receiver reaches the 10 mL mark.

If necessary, the volume in the Distilling Receiver may be brought up to 10 mL with HgEx Reagent B. To avoid low volumes in the future, disconnect the vacuum a little sooner in step 6. This leaves more HgEx Reagent B in the packing of the Mercury Absorber Column.

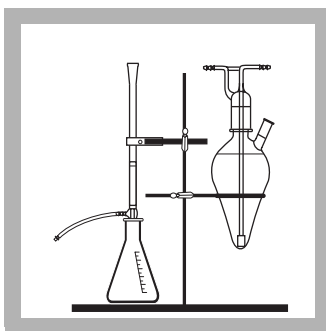

18. Remove the distilling Receiver from the Mercury Absorber Column. Reconnect the 100-mL Erlenmeyer flask to the column.

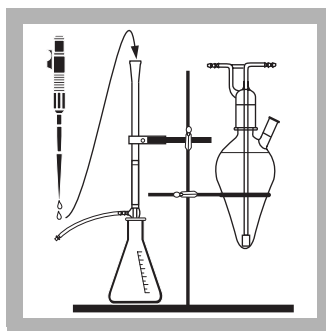

19. Pipet 3 mL of HgEx Reagent B into the Mercury Absorber Column without applying vacuum. This keeps the absorber packing wet between tests.

The Mercury Absorber Column eluate in the Distilling Receiver is ready for analysis.

Proceed to Phase 3.

Phase 3: Colorimetric Analysis

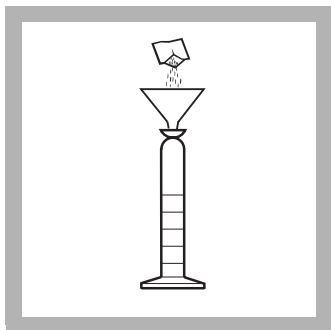

1. Using the funnel provided, add the contents of one HgEx Reagent 3 foil pillow to the eluate in the Distilling Receiver. Stopper the receiver. Invert to dissolve the reagent.

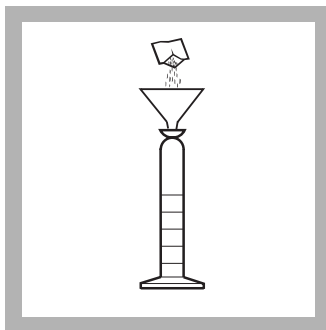

2. Add the contents of one HgEx Reagent 4 foil pillow to the Distilling Receiver using the funnel provided. Stopper the receiver. Invert to dissolve the reagent.

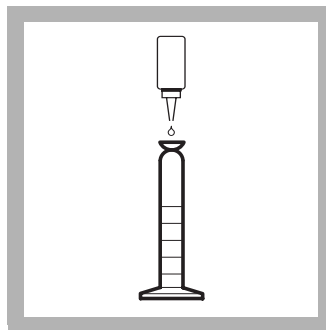

3. Add 8 drops of HgEx Reagent 5 to the Distilling Receiver. Stopper the Receiver. Invert to mix.

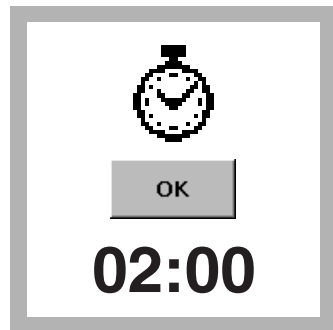

4. Press **TIMER>OK**. A two-minute reaction period will begin.

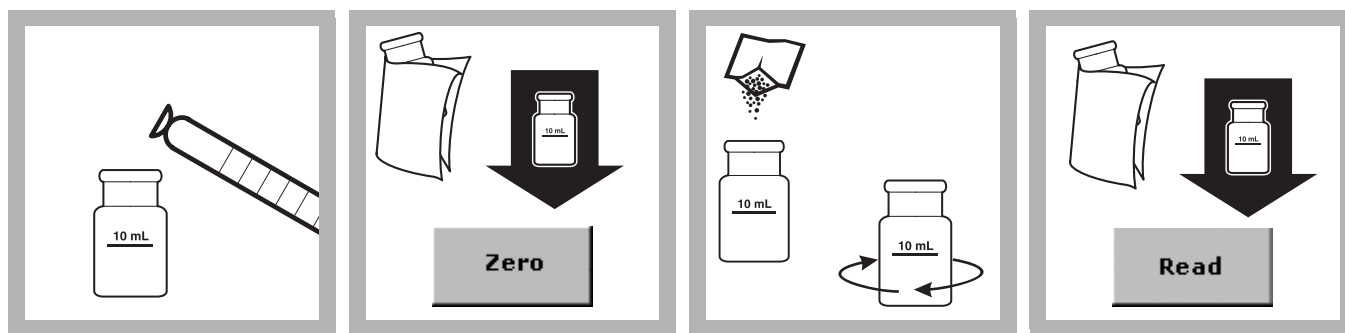

5. During the reaction period, transfer the solution to a sample cell.

6. Wipe the sample cell. After the timer expires, insert the sample into the cell holder with the fill line facing right.

Press **ZERO**.

The display will show:

0.1 µg/L Hg

(This program uses a non-zero intercept.)

7. Remove the cell from the cell holder. Add the contents of one HgEx Reagent 6 foil pillow to the solution. Swirl the cell until the reagent is completely dissolved. Immediately go to step 8.

Do not use the funnel to add HgEx Reagent 6 to the sample cell. Any HgEx Reagent 6 in the funnel will make mercury undetectable in subsequent tests.

8. Return the sample cell to the cell holder with the fill line facing right.

Press **READ**. Results are in µg/L Hg.

Interferences

Standards were used to prepare a single test solution with the following matrix. A second test solution containing only mercury at the same concentration was prepared as the control. The two solutions were digested then analyzed concurrently. There was no interference from the matrix of the test solution at the concentrations listed.

In addition, no interference occurred with a test solution containing 1000 mg/L Na⁺, 1000 mg/L K⁺, 1000 mg/L Mg²⁺, and 400 mg/L Ca²⁺.

Table 1 Interfering Substances and Levels

Ion or Substance	Concentration
Ag ⁺	7 mg/L Ag ⁺
Al ³⁺	10 mg/L Al ³⁺
Au ³⁺	500 µg/L Au ³⁺
Cd ²⁺	10 mg/ L Cd ²⁺
Co ²⁺	10 mg/L Co ²⁺
Cr ⁶⁺	10 mg/L Cr ⁶⁺
Cu ²⁺	10 mg/L Cu ²⁺
F ⁻	1.0 mg/L F ⁻
Fe ²⁺	100 mg/L Fe ²⁺
Hg ²⁺	1 µg/L Hg ²⁺
Mo ⁶⁺	10 mg/L Mo ⁶⁺
Ni ²⁺	10 mg/L Ni ²⁺

Table 1 Interfering Substances and Levels (continued)

Ion or Substance	Concentration
NO ₃ ⁻ -N	50 mg/L NO ₃ ⁻ -N
Pb ²⁺	10 mg/L Pb ²⁺
SiO ₂	100 mg/L SiO ₂
Zn ⁺²	10 mg/L Zn ⁺²

Sample Collection and Preservation

Collect 1000 mL of sample in an analytically clean, glass or polyethylene terephthalate (PET) container. Add 10 mL of concentrated hydrochloric acid to preserve the sample before sample collection. Fill the container completely full to minimize air space when closed. Close a glass container with a ground glass stopper. Close a PET container with a PET cap or a polypropylene cap (no liner).

Store aqueous samples at 2–6 °C. Acid-preserved samples are stable for at least 6 months.

Accuracy Check

Standard Additions Method

1. Prepare a 10.0-mg/L Mercury Standard Solution as described under [Standard Solution Method](#), step 3a.
2. Use a TenSette® Pipet to add 0.10 mL of the 10.0-mg/L Mercury Standard Solution to the purged solution in the Gas Washing Bottle after an analysis has been performed. Immediately stopper the Gas Washing Bottle.
3. Begin at step 3 of Phase 2. Follow the procedure steps.
4. Test the eluate as described in Phase 3. The displayed concentration should be 0.9–1.1 µg/L Hg.

Standard Solution Method

1. Transfer 800 mL of deionized water into the Gas Washing Bottle.
2. Add 50 mL of concentrated sulfuric acid and 25 mL of concentrated nitric acid to the water. Swirl to mix.
3. Prepare a 0.1-mg/L mercury standard solution by serially diluting a 1000-mg/L Mercury Standard Solution:
 - a. To make a 10.0 mg/L standard, add 1.0 mL of concentrated nitric acid to a 500-mL volumetric flask. Dilute 5.00 mL of a 1000-mg/L standard to 500 mL with deionized water. Mix well.
 - b. To make a 1.0-mg/L standard solution, add 0.2 mL of concentrated nitric acid to a 100-mL volumetric flask. Dilute 10.0 mL of the 10.0-mg/L standard to 100 mL with deionized water. Mix well.
 - c. To make a 0.1-mg/L standard solution, add 0.2 mL of concentrated nitric acid to a 100-mL volumetric flask. Dilute 10.00 mL of the 1.0-mg/L solution to 100 mL with deionized water. Mix well.

4. Pipet 10.0 mL of the 0.1-mg/L mercury standard solution into the Gas Washing Bottle. Swirl to mix.
5. Begin at step 2 of Phase 2. Follow the procedure steps.
6. Test the eluate as described in Phase 3. The displayed concentration should be 0.9–1.1 µg/L Hg.

System Start Up

For more accurate results, perform a few analyses on mercury standards and blanks for system equilibration before beginning sample testing. This allows the system to stabilize before processing samples.

Startup Standard

Test a mercury standard solution by following the procedure under [Accuracy Check](#) using the [Standard Solution Method](#). Continue with step 1 of the Startup Standard procedure if the value is not within specified limits.

1. Pipet 10.0 mL of the 0.1-mg/L mercury standard solution into the purged solution in the Gas Washing Bottle. Immediately stopper the Gas Washing Bottle.
2. Begin at step 3 of Phase 2. Follow the procedure steps.
3. Test the eluate as described in Phase 3. The displayed concentration should be 0.9–1.1 µg/L Hg. Repeat steps 1–3 if the value is not within these limits.

Startup Blank

Run a system blank by using the purged solution in the Gas Washing Bottle after a satisfactory test of the Startup Standard has been completed.

1. Leave the purged solution in the Gas Washing Bottle. Do not add an aliquot of mercury standard.
2. Begin at step 3 of Phase 2. Follow the procedure steps.
3. Test the eluate as described in Phase 3. The displayed concentration should be ≤ 0.2 µg/L Hg. Repeat the Startup Blank procedure until a reproducible value is obtained.

Storage and Maintenance of the Cold Vapor Mercury Apparatus

Storage

Store the apparatus as follows for fastest system stabilization and greatest sensitivity:

- Store the Gas Washing Bottle filled with deionized water containing 15 mL of concentrated sulfuric acid. Seal the bottle with the Gas Washing Bottle stopper and top.
- Store the Mercury Absorber Column with the packing wetted with HgEx Reagent B. The erlenmeyer flask should be kept attached underneath the column. The top of the Mercury Absorber column should be attached to the Gas Washing Bottle with the glass elbow as in the procedure.

Glassware Care

Use of dedicated glassware and sample cells is recommended because of the sensitivity of this procedure. Thoroughly clean the glassware and sample cells between tests. After washing, rinse with 1:1 hydrochloric acid solution, then rinse several times with deionized water.

Maintaining the System

- With proper care and storage, the Mercury Absorber Column may be used an unlimited number of times.
- Replace the Mercury Scrubber in the air trap housing at least once for every reagent set used.
- Moisture build up on the Gas Washing Bottle side of the Acro 50 Vent Filter will reduce the purging air flow rate. If this occurs replace the filter or dry it in an oven at 110 °C.

Summary of Method

The sample is digested to convert all forms of mercury in the sample to mercuric (Hg^{2+}) ions. The mercuric ions in the digested sample are converted to mercury vapor in a semi-closed system. The vapor is carried into a chemically activated absorber column by ambient air where the mercury vapor is converted to mercuric chloride.

The mercuric chloride is eluted off the column and a sensitive indicator is added. The instrument is zeroed using the absorbance peak of the unreacted indicator. A complexing agent is added to break the mercury:indicator complex. The increase in unreacted indicator causes an increase in absorbance proportional to the amount of mercury in the original sample. Test results are measured at 412 nm.

Safety

Wear personal protective equipment such as safety glasses with side shields, or a face shield to protect your eyes. Use other protective equipment as necessary (such as a fume hood) to avoid chemical exposure. Perform all steps exactly as prescribed in the procedure.

Pollution Prevention and Waste Management

Proper management and disposal of waste is the responsibility of the waste generator. It is up to the generator to arrange for proper disposal and comply with applicable local, state, and federal regulations governing waste disposal. The manufacturer makes no guarantees or warranties, express or implied, for the waste disposal information represented in this procedure.

1. Dispose of the solution in the Gas Washing Bottle by neutralizing the solution to a pH of 6–9 and flushing to the sanitary sewer with water for several minutes.
2. The mercury contained in one liter of sample is concentrated by a factor of 100 by the Mercury Absorber Column. Mercury analysis within the range of the test may produce a solution in the sample cell that is above the RCRA Toxicity Characteristic limit of 0.20 mg/L Hg. The sample cell will contain 0.25 mg/L mercury if the original sample was at 2.5 µg/L mercury (the upper limit of the test range). Dispose of the solution in the sample cell as a hazardous waste if the test result was over 2 µg/L mercury in the original sample. Otherwise, pour the solution into the sanitary sewer and flush with water for several minutes.
3. The mercury scrubber will capture mercury vapor if the Mercury Absorber Column is not properly activated using HgEx Reagent B and HgEx Reagent C. In addition, mercury is also captured if the capacity of the Absorber Column is exceeded. If the Mercury Scrubber has captured mercury vapor, it must be disposed of according to applicable regulations.

Consumables and Replacement Items

Required Reagents

Description	Quantity/Test	Unit	Cat. No.
Cold Vapor Mercury Reagent Set (25 tests), Includes:			26583-00
HgEx™ Reagent A, Stannous Sulfate Solution, 20-mL ampules	1	25/pkg	26588-25
HgEx™ Reagent B, Sulfuric Acid Solution	19 mL	500 mL	26589-49
HgEx™ Reagent C, Sodium Hypochlorite Solution	2 mL	55 mL	26590-59
HgEx™ Reagent 3, Alkaline Reagent Powder Pillows	1 pillow	25/pkg	26584-48
HgEx™ Reagent 4, Indicator Powder Pillows	1 pillow	25/pkg	26585-48
HgEx™ Reagent 5, Sodium Hydroxide Solution	8 drops	10 mL SCDB	26586-36
HgEx™ Reagent 6, Complexing Reagent Powder Pillows	1 pillow	25/pkg	26587-48
Mercury Scrubber	2/reagent set	2/pkg	26558-00

Required Apparatus

Description	Quantity/Test	Unit	Cat. No.
Cold Vapor Mercury Apparatus Set	1	each	26744-00
Acro 50 Vent Filter	1	18/pkg	26833-18
Air Trap Holder Assembly	1	each	26639-00
Ampule Breaker	1	each	25640-00
Breaker/Capper Tool for Mercury Scrubber	1	each	26640-00
C-flex Tubing, 0.25-inch ID, white	4 ft	25 ft	23273-67
Clamp for Mercury Absorber Column	1	each	26562-00
Clamp Holder	2	each	326-00
Cylinder, graduated, 50-mL	1	each	508-41

Required Apparatus (continued)

Description	Quantity/Test	Unit	Cat. No.
Distilling Receiver, 10-mL	1	each	26554-38
Flask, Erlenmeyer, 100-mL	1	each	26553-42
Funnel, micro	1	each	25843-35
Gas Washing Bottle, 1200-mL	1	each	26622-00
Glass Elbow, 90-degree, with hose adapter	1	each	26552-00
Mercury Absorber Column	1	each	26555-10
Pipet, TenSette®, 0.1 to 1.0 mL	1	each	19700-01
Pipet, TenSette, 1.0 to 10.0 mL	1	each	19700-10
Pipet Tips, for TenSette Pipet 19700-01	varies	50/pkg	21856-96
Pipet Tips, for 19700-10 TenSette Pipet	varies	50/pkg	21997-96
Sample Cells, 1-inch square, 10-mL, matched pair	1	2/pkg	24954-02
Support Ring for Gas Washing Bottle	1	each	26563-00
Stopper, for Distilling Receiver	1	each	26559-00
Stopper, for Gas Washing Bottle	1	each	26623-00
Support, Base and Rod	1	each	329-00
Tubing Quick Disconnect, HDPE	1	12/pkg	14810-00
Vacuum Pump, 115 VAC w/ North American Plug	1	each	28248-00
Vacuum Pump, 220 VAC w/ North American Plug	1	each	28248-01
Vacuum Pump, 220 V w/ European Plug	1	each	28248-02

Required Digestion Reagents and Apparatus

Description	Quantity/Test	Unit	Cat. No.
Flask, Erlenmeyer, 2000-mL	1	each	24894-54
Hot Plate/Stirrer, 120 VAC	1	each	23442-00
Hot Plate/Stirrer, 240 VAC	1	each	23440-02
Hydroxylamine Hydrochloride, ACS	varies	113 g	246-14
Nitric Acid, ACS	25 mL	500 mL	152-49
Potassium Permanganate, ACS	varies	454 g	168-01H
Potassium Persulfate, ACS	4.0 g	454 g	26175-01
Sulfuric Acid, ACS, concentrated	50 mL	4 kg	979-09
Spoon, measuring, 0.5-g	1	each	907-00
Stir Bar	1	each	20953-55
Thermometer, -20 to 110 °C	1	each	566-01
Watch Glass, Pyrex, 65-mm	1	each	578-67

Recommended Standards

Description	Unit	Cat. No.
Mercury Standard Solution, 1000-mg/L Hg (NIST)	100 mL	14195-42
Water, deionized	4 L	272-56



FOR TECHNICAL ASSISTANCE, PRICE INFORMATION AND ORDERING:

In the U.S.A. – Call toll-free 800-227-4224
Outside the U.S.A. – Contact the HACH office or distributor serving you.
On the Worldwide Web – www.hach.com; E-mail – techhelp@hach.com

HACH COMPANY
WORLD HEADQUARTERS
Telephone: (970) 669-3050
FAX: (970) 669-2932

Molybdenum, Molybdate

Method 8036

Mercaptoacetic Acid Method¹

Powder Pillows or AccuVac[®] Ampuls

HR (0.2 to 40.0 mg/L)

Scope and Application: For water and wastewater.

¹ Adapted from *Analytical Chemistry*, 25(9) 1363 (1953)



Test Preparation

Before starting the test:

For more accurate results, determine a reagent blank value for each new lot of reagent. Follow the procedure using deionized water instead of the sample.

Filter turbid samples using filter paper¹ and a funnel¹.

After all reagents have been added, the presence of molybdenum will cause a yellow color to form.

Collect the following items:

Quantity

Collect the following items:	Quantity
Powder Pillow Test:	
MolyVer [®] 1 Molybdenum Reagent Powder Pillows	1
MolyVer [®] 2 Molybdenum Reagent Powder Pillows	1
MolyVer [®] 3 Molybdenum Reagent Powder Pillows	1
Sample Cells, 1-inch square, 10-mL	2
AccuVac Test:	
CDTA Solution, 0.4 M	4 drops
MolyVer [®] 6 Reagent AccuVac [®] Ampuls	1
Beaker, 50 mL	1
Sample Cells, 10-mL, with cap	1

Note: Reorder information for consumables and replacement items is on page 6.

¹ See [Optional Reagents and Apparatus](#) on page 6.

Powder Pillows

Method 8036



1. Press **STORED PROGRAMS**.



2. Select the test.

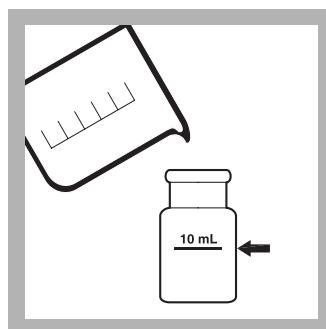

3. Fill a square sample cell with 10-mL of sample.

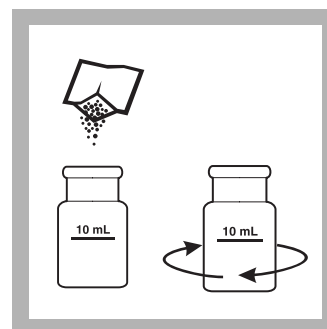

4. **Prepared Sample:** Add the contents of one MolyVer[®] 1 Reagent Powder Pillow. Swirl to mix.

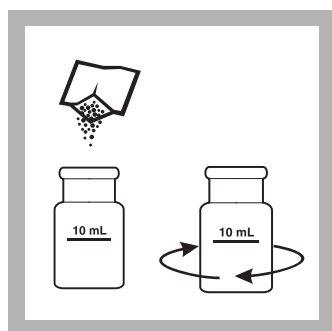

5. Add the contents of one MolyVer 2 Reagent Powder Pillow. Swirl to mix.

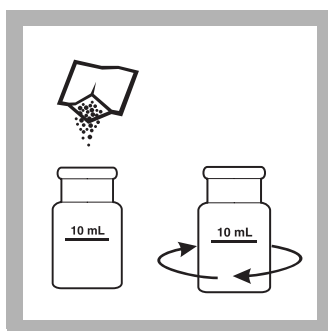

6. Add the contents of one MolyVer 3 Reagent Powder Pillow. Swirl to mix.

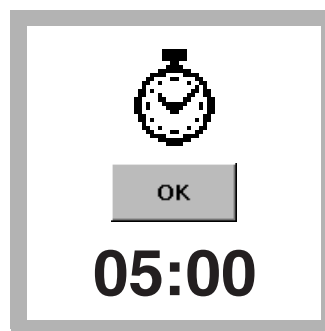

7. Press **TIMER>OK**.
A five-minute reaction period will begin.

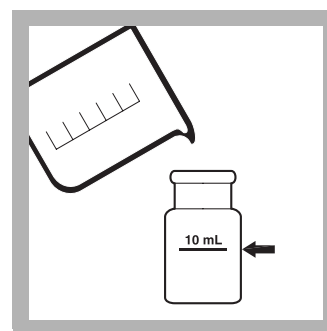

8. **Blank Preparation:**
When the timer expires, fill a second square sample cell with 10 mL of the original sample.



9. Insert the blank into the cell holder with the fill line facing right.

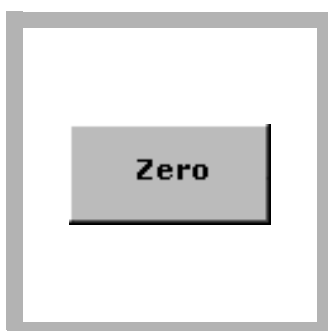

10. Press **ZERO**.
The display will show:
0.0 mg/L Mo⁶⁺



11. Insert the prepared sample into the cell holder with the fill line facing right.



12. Press **READ**.
Results are in mg/L Mo⁶⁺.

AccuVac Ampul

Method 8036

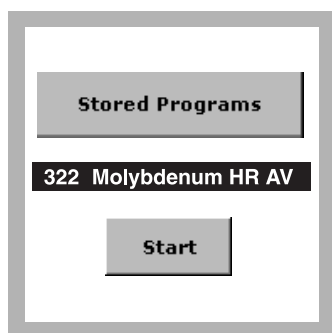

1. Select the test.

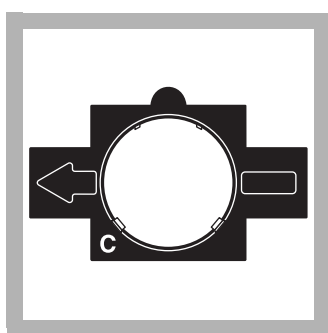

2. Insert Adapter C.

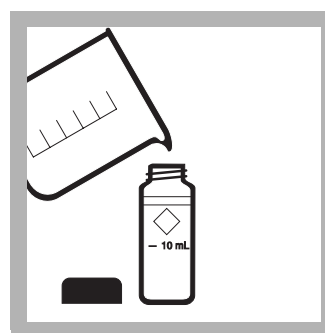

3. **Blank Preparation:**
Fill a round sample cell with 10 mL of sample.

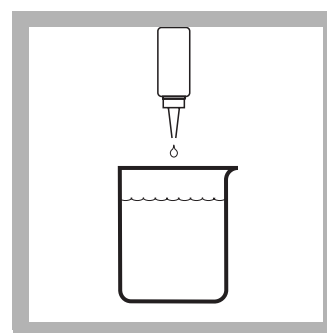

4. **Prepared Sample:**
Collect 40 mL of sample in a 50-mL beaker. Add four drops of 0.4 M CDTA Standard Solution to the sample in the beaker. Swirl to mix.

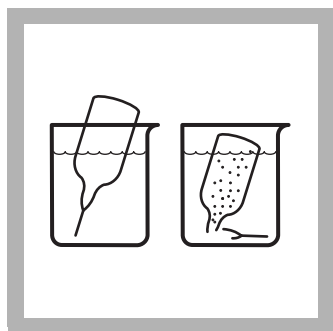

5. Fill a MolyVer 6 AccuVac® Ampul with the treated sample.



6. Invert the Ampul several times to mix. Undissolved reagent will not affect test results.

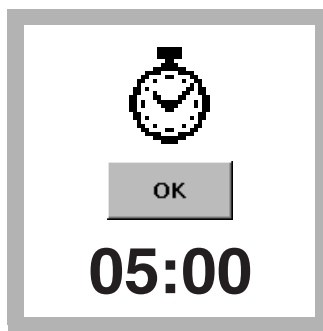

7. Press **TIMER>OK**. A five-minute reaction period will begin.



8. When the timer expires, insert the blank into the cell holder.

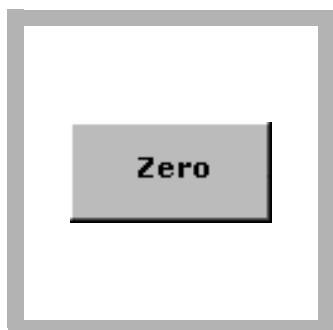

9. Press **ZERO**. The display will show:
0.0 mg/L Mo⁶⁺



10. Insert the prepared sample into the cell holder. Press **READ**. Results are in mg/L Mo⁶⁺.

Interferences

Table 1 Interfering Substances and Levels

Interfering Substance	Interference Levels and Treatments
Aluminum	Greater than 50 mg/L
Chromium	Greater than 1000 mg/L
Copper	Samples containing 10 mg/L copper or more will exhibit an increasing positive interference upon standing. Read these samples as soon as possible after the five minute reaction period is complete.
Iron	Greater than 50 mg/L
Nickel	Greater than 50 mg/L
Nitrite	Interference from up to 2000 mg/L as NO ₂ ⁻ can be eliminated by adding one Sulfamic Acid Powder Pillow ¹ to the sample.
Highly buffered samples or extreme sample pH	May exceed the buffering capacity of the reagents and require sample pretreatment.

¹ See [Optional Reagents and Apparatus](#) on page 6.

Sample Collection, Storage, and Preservation

Collect samples in clean plastic or glass bottles. Adjust the pH to 2 or less with nitric acid (about 2 mL/L). Preserved samples can be stored up to 6 months at room temperature. Adjust the pH to 7 with 5.0 N Sodium Hydroxide before analysis. Correct the test result for volume additions.

Accuracy Check

Standard Additions Method (Sample Spike)

1. After reading test results, leave the sample cell (unspiked sample) in the instrument. Verify the chemical form.
2. Press **OPTIONS>MORE**. Press **STANDARD ADDITIONS**. A summary of the standard additions procedure will appear.
3. Press **OK** to accept the default values for standard concentration, sample volume, and spike volumes. Press **EDIT** to change these values. After values are accepted, the unspiked sample reading will appear in the top row. See the user manual for more information.
4. Open a bottle of Molybdenum Standard Solution, 1000-mg/L Mo⁶⁺.
5. Prepare three sample spikes. Fill three Mixing Cylinders* with 30 mL of sample. Use the TenSette® Pipet to add 0.2 mL, 0.4 mL, and 0.6 mL of standard, respectively, to each sample and mix thoroughly.

Note: For AccuVac® Ampuls, fill three Mixing Cylinders* with 60-mL of sample and spike with 0.4 mL, 0.8 mL, and 1.2 mL of standard. Transfer 40 mL from each of the three mixing cylinders to three 50-mL Beakers*. Analyze each standard addition sample as described in the procedure above. Accept each standard additions reading by pressing **READ**. Each addition should reflect approximately 100% recovery.

6. Analyze each sample spike as described in the procedure above, starting with the 0.2 mL sample spike. Accept each standard additions reading by pressing **READ**. Each addition should reflect approximately 100% recovery.
7. After completing the sequence, press **GRAPH** to view the best-fit line through the standard additions data points, accounting for the matrix interferences. Press **IDEAL LINE** to view the relationship between the sample spikes and the “Ideal Line” of 100% recovery.

* See [Optional Reagents and Apparatus on page 6](#).

Standard Solution Method

To assure the accuracy of the test, use a Molybdenum Standard Solution, 10.0-mg/L Mo^{6+} . Follow the procedure for powder pillows or AccuVac Ampuls.

Standard Adjust

1. Use a Molybdenum Standard Solution, 10.0 mg/L Mo^{6+} to perform the molybdenum procedure as described above.
2. To adjust the calibration curve using the reading obtained with the standard solution, press **OPTIONS>MORE** on the current program menu. Press **STANDARD ADJUST**.
3. Press **ON**. Press **ADJUST** to accept the displayed concentration. If an alternate concentration is used, press the number in the box to enter the actual concentration, then press **OK**. Press **ADJUST**.

Summary of Method

MolyVer 1 and 2 Reagents are added to buffer and condition the sample. MolyVer 3 provides the mercaptoacetic acid which reacts with molybdate molybdenum to form a yellow color proportional to the molybdenum concentration. Test results are measured at 420 nm.

Consumables and Replacement Items

Required Reagents (Powder Pillows)

Description	Quantity/Test	Unit	Cat. No.
Molybdenum Reagent Set, for 10-mL samples (100 tests):	—	—	26041-00
MolyVer® 1 Molybdenum Reagent Powder Pillows	1	100/pkg	26042-99
MolyVer® 2 Molybdenum Reagent Powder Pillows	1	100/pkg	26043-99
MolyVer® 3 Molybdenum Reagent Powder Pillows	1	100/pkg	26044-99
OR			
CDTA Solution, 0.4 M	4 drops	15 mL SCDB	26154-36
MolyVer® 6 Reagent AccuVac® Ampuls	1	25/pkg	25220-25

Required Apparatus (Powder Pillows)

Description	Quantity/Test	Unit	Cat. No.
Sample Cells, 1-inch square, 10 mL, matched pair	2	2/pkg	24954-00

Required Apparatus (AccuVac)

Description	Quantity/Test	Unit	Cat. No.
Adapter, 1-inch round, for AccuVac Ampuls	1	each	LZV584
Beaker, 50-mL	1	each	500-41H
Sample Cell, 10-mL, with cap	1	each	21228-00

Recommended Standards

Description	Unit	Cat. No.
Molybdenum Standard Solution, 10-mg-L as Mo	100 mL	14187-42
Molybdenum Standard Solution, 1000-mg-L as Mo	100 mL	14186-42
Water, deionized	4 L	272-56

Optional Reagents and Apparatus

Description	Cat. No.
Beakers, 50-mL	500-41H
Cylinder, mixing, 50 mL	1896-41
Filter Paper	1894-57
Funnel	1083-67
Pipet, TenSette®, 0.1 to 1.0 mL	19700-01
Pipet Tips, for TenSette Pipet 19700-01	21856-96
Sulfamic Acid Powder Pillow	1055-99



FOR TECHNICAL ASSISTANCE, PRICE INFORMATION AND ORDERING:
 In the U.S.A. – Call toll-free 800-227-4224
 Outside the U.S.A. – Contact the HACH office or distributor serving you.
 On the Worldwide Web – www.hach.com; E-mail – techhelp@hach.com

HACH COMPANY
 WORLD HEADQUARTERS
 Telephone: (970) 669-3050
 FAX: (970) 669-2932

Molybdenum, Molybdate

Method 8169

Ternary Complex Method

Powder Pillows

(0.02 to 3.00 mg/L)

Scope and Application: For boiler and cooling tower waters



Test Preparation

Before starting the test:

Analyze samples immediately after collection.

Filter turbid samples using filter paper¹ and a funnel¹.

¹ See [Optional Reagents and Apparatus on page 5](#).

Collect the following items:

Quantity

Molybdenum Reagent Set for 20-mL sample	
Molybdenum 1 Reagent (LR) Molybdate Powder Pillow	1
Molybdenum 2 Reagent Solution	0.5 mL
Cylinder, graduated mixing, 25-mL	1
Sample Cells, 1-inch square, 10 mL, matched pair	2

Note: Reorder information for consumables and replacement items is on [page 5](#).

Powder Pillows

Method 8169



1. Press **STORED PROGRAMS**.

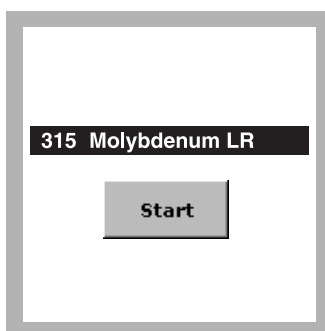

2. Select the test.

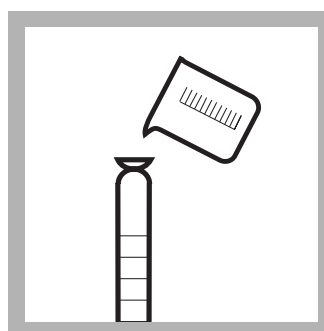

3. Fill a 25-mL graduated mixing cylinder with 20 mL of sample.

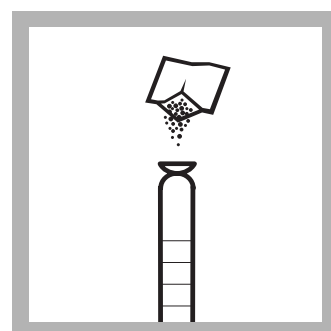

4. Add the contents of one Molybdenum 1 Reagent Powder Pillow to the graduated cylinder.

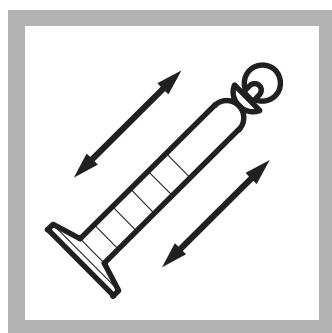

5. Prepared Sample:
Stopper the cylinder and shake to dissolve the reagent.

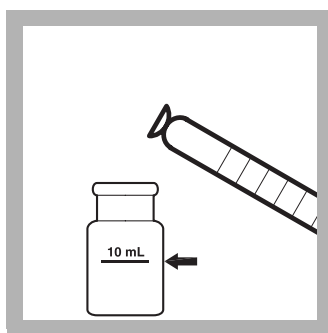

6. Pour 10-mL of the prepared sample into a square sample cell.

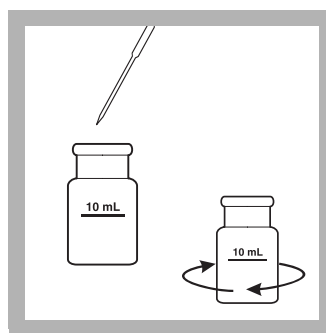

7. Developed Sample:
Add 0.5 mL of Molybdenum 2 Reagent to the sample cell. Swirl to mix.

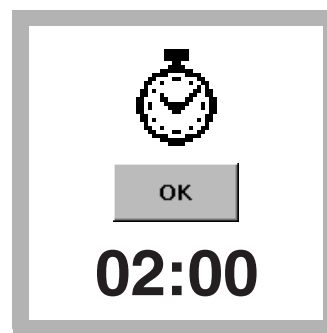

8. Press **TIMER>OK**.
A two-minute reaction period will begin.

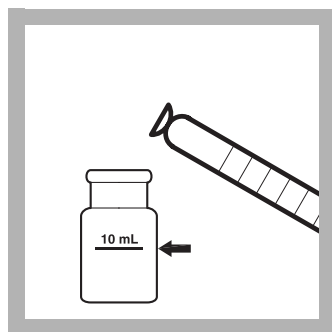

9. Blank Preparation:
When the timer expires, fill a second square sample cell with 10 mL of the remaining prepared sample.



10. Wipe the blank and insert it into the cell holder with the fill line facing right.

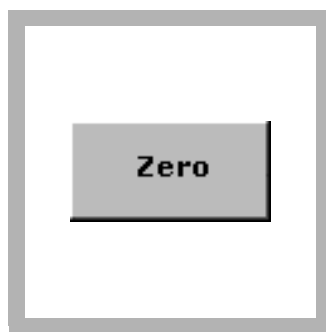

11. Press **ZERO**.
The display will show:
0.00 mg/L Mo⁶⁺



12. Wipe the developed sample and insert it into the cell holder with the fill line facing right.

Press **READ**. Results are in mg/L Mo⁶⁺.

Interferences

Interferences studies were conducted by preparing a molybdenum standard solution (2-mg/L Mo⁶⁺) as well as a solution of the potential interfering ion. When the standard solution concentration changed by ± 5% with a given ion concentration, the ion was considered an interference. Tables 1–3 list the details of these studies.

Table 1 Substances That Cause a Negative Interference

Interfering Substance	Interference Levels and Treatments
Alum	Greater than 7 mg/L
Aluminum	Greater than 2 mg/L
AMP (Phosphonate)	Greater than 15 mg/L
Bicarbonate	Greater than 5650 mg/L
Bisulfate	Greater than 3300 mg/L
Borate	Greater than 5250 mg/L
Chloride	Greater than 1400 mg/L
Chromium	Greater than 4.5 mg/L ¹

Table 1 Substances That Cause a Negative Interference (continued)

Interfering Substance	Interference Levels and Treatments
Copper	Greater than 98 mg/L
Diethanoldithiocarbamate	Greater than 32 mg/L
EDTA	Greater than 1500 mg/L
Ethylene Glycol	Greater than 2% (by volume)
Iron	Greater than 200 mg/L
Lignin Sulfonate	Greater than 105 mg/L
Nitrite	Greater than 350 mg/L
Orthophosphate	Greater than 4500 mg/L
Phosphonohydroxyacetic Acid	Greater than 32 mg/L
HEDP (Phosphonate)	The presence of the phosphonate HEDP at concentrations up to 30 mg/L will increase the apparent molybdenum concentration reading by approximately 10% (positive interference). Multiply the value obtained in step12 by 0.9 to obtain the actual Mo ⁶⁺ concentration.
Sulfite	Greater than 6500 mg/L

¹ Read the molybdenum concentration immediately after the beep of the 2-minute reaction period.

Table 2 Substances That Cause a Positive Interference

Interfering Substance	Interference Levels and Treatments
Benzotriazole	Greater than 210 mg/L
Carbonate	Greater than 1325 mg/L
Morpholine	Greater than 6 mg/L
Phosphonate HEDP	Positive interference of about 10% up to 30 mg/L. As the concentration increases above 30 mg/L, a decrease in the molybdenum concentration reading occurs (negative interference).
Silica	Greater than 600 mg/L

Table 3 Non-interfering Substances

Interfering Substance	Interference Levels and Treatments
Bisulfite	9600 mg/L
Calcium	720 mg/L
Chlorine	7.5 mg/L
Magnesium	8000 mg/L
Manganese	1600 mg/L
Nickel	250 mg/L
PBTC (phosphonate)	500 mg/L
Sulfate	12,800 mg/L
Zinc	400 mg/L

Highly buffered samples or extreme sample pH may exceed the buffering capacity of the reagent and require sample pretreatment. Adjust the sample pH to between 3–5 by adding, dropwise, an appropriate amount of acid or base such as 1.0 N Sulfuric Acid Standard Solution*, or 1.0 N Sodium Hydroxide Standard Solution*. If significant volumes of acid or base are used, a volume correction should be made by dividing the total volume (sample + acid + base) by the original volume and multiplying the test result by this factor.

After a number of samples have been analyzed, the sample cells may exhibit a slight blueish discoloration. Rinse the cells with 1:1 Hydrochloric Acid Solution† to eliminate this build-up.

* See [Optional Reagents and Apparatus](#) on page 5.

Sample Collection, Storage, and Preservation

Collect samples in glass or plastic bottles. Analyze samples immediately.

Accuracy Check

Standard Additions Method (Sample Spike)

1. After reading test results, leave the sample cell (unspiked sample) in the instrument. Verify the chemical form.
2. Press **OPTIONS>MORE**. Press **STANDARD ADDITIONS**. A summary of the standard additions procedure will appear.
3. Press **OK** to accept the default values for standard concentration, sample volume, and spike volumes. Press **EDIT** to change these values. After values are accepted, the unspiked sample reading will appear in the top row. See the user manual for more information.
4. Snap the neck off a Molybdenum Voluette[®] Ampule Standard, 500-mg/L Mo⁶⁺.
5. Prepare three sample spikes. Fill three mixing cylinders* with 100 mL of sample. Use the TenSette[®] Pipet to add 0.1 mL, 0.2 mL, and 0.3 mL of standard, respectively, to each sample and mix thoroughly.
6. Analyze 20 mL of each standard addition sample as described in the procedure above, starting with the 0.1 mL sample spike. Accept each standard additions reading by pressing **READ**. Each addition should reflect approximately 100% recovery.
7. After completing the sequence, press **GRAPH** to view the best-fit line through the standard additions data points, accounting for the matrix interferences. Press **IDEAL LINE** to view the relationship between the sample spikes and the "Ideal Line" of 100% recovery.

Standard Solution Method

1. Using Class A glassware, prepare a 2.00-mg/L molybdenum standard solution by pipetting 10.00 mL of Molybdenum Standard Solution, 10.00-mg/L, into a 50-mL volumetric flask. Dilute to the mark with deionized water. Prepare this solution daily. Perform the molybdenum procedure as described above.
2. To adjust the calibration curve using the reading obtained with the standard solution, press **OPTIONS>MORE** on the current program menu. Press **STANDARD ADJUST**.
3. Press **ON**. Press **ADJUST** to accept the displayed concentration. If an alternate concentration is used, press the number in the box to enter the actual concentration, then press **OK**. Press **ADJUST**.

Summary of Method

The ternary complex method for molybdenum determination is a method in which molybdate molybdenum reacts with an indicator and sensitizing agent to give a stable blue complex. Test results are measured at 610 nm.

† See [Optional Reagents and Apparatus on page 5](#).

Consumables and Replacement Items

Required Reagents

Description	Quantity/Test	Unit	Cat. No.
Molybdenum Reagent Set for 20-mL sample (100 tests), includes:	—	—	24494-00
(1) Molybdenum 1 Reagent (LR) Molybdate Powder Pillows	1	100/pkg	23524-49
(1) Molybdenum 2 Reagent Solution	0.5 mL	50 mL MDB	23525-12

Required Apparatus

Description	Quantity/Test	Unit	Cat. No.
Sample Cells, 1-inch square, 10 mL, matched pair	2	2/pkg	24954-02
Cylinder, graduated mixing, 25-mL	1	each	1896-40

Recommended Standards

Description	Unit	Cat. No.
Molybdenum Standard Solution, 10-mg/L Mo ⁶⁺	100 mL	14187-42
Molybdenum Standard Solution, 10-mL Voluette® ampule, 500-mg/L Mo ⁶⁺	16/pkg	14265-10
Water, deionized	4 L	272-56

Optional Reagents and Apparatus

Description	Cat. No.
Cylinder, mixing, 100 mL	1896-42
Filter Paper	1894-57
Funnel	1083-67
Hydrochloride Acid Solution 1:1	884-49
Pipet, TenSette®, 0.1–1.0 mL	19700-01
Pipet Tips, for TenSette Pipet 19700-01	21856-96
Sodium Hydroxide Standard Solution, 1.0 N	1045-32
Sulfuric Acid Standard Solution, 1.0 N	1270-32



FOR TECHNICAL ASSISTANCE, PRICE INFORMATION AND ORDERING:

In the U.S.A. – Call toll-free 800-227-4224
Outside the U.S.A. – Contact the HACH office or distributor serving you.
On the Worldwide Web – www.hach.com; E-mail – techhelp@hach.com

HACH COMPANY
WORLD HEADQUARTERS
Telephone: (970) 669-3050
FAX: (970) 669-2932

Method 8150

1-(2 Pyridylazo)-2-Naphthol (PAN) Method¹

Powder Pillows

(0.006 to 1.000 mg/L)

Scope and Application: For water and wastewater; digestion is required for determining total nickel

¹ Adapted from Watanabe, H., *Talanta*, 21 295 (1974)



Test Preparation

Before starting the test:

Cobalt concentration can be determined with the same sample by using Program Number 110.

Collect the following items:

Quantity

EDTA Powder Pillow	2
Phthalate-Phosphate Reagent Powder Pillows	2
PAN Indicator Solution, 0.3%	1 mL
Deionized Water	25 mL
Sample Cells, 1-inch square, 10-mL	2
Stoppers	2

Note: Reorder information for consumables and replacement items is on page 5.

Powder Pillows

Method 8150



1. Press **STORED PROGRAMS**.



2. Select the test.

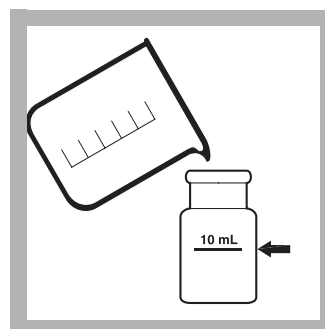

3. **Prepared Sample:**
Fill a square sample cell to the 10-mL mark with sample.

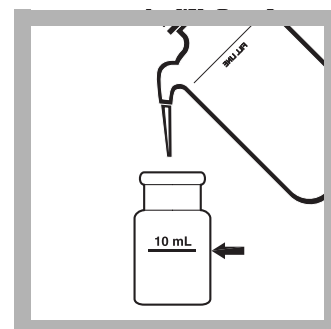

4. **Blank Preparation:**
Fill a second square sample cell to the 10-mL mark with deionized water.

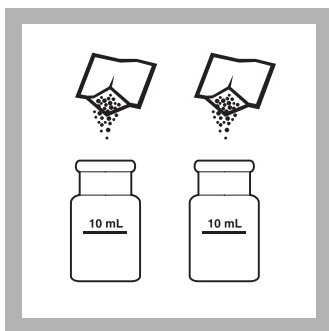

5. Add the contents of one Phthalate-Phosphate Reagent Powder Pillow to each cell.

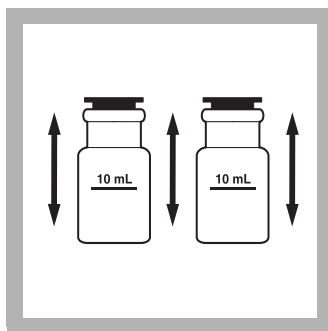

6. Stopper the cells. Immediately shake to dissolve.
If the sample contains iron, make sure that all the powder is dissolved before proceeding to step 7.

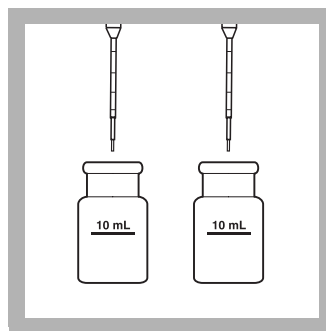

7. Using the provided plastic dropper, add 0.5 mL of 0.3% PAN Indicator Solution to each cell.

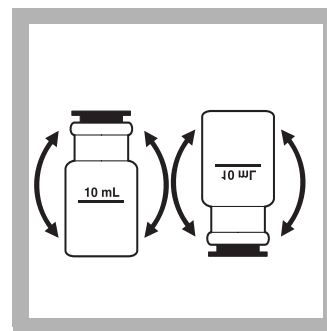

8. Stopper the cells. Invert several times to mix.



9. Press **TIMER>OK**.

A 15-minute reaction period will begin.

During color development, the sample solution color may vary from yellowish-orange to dark red, depending on the chemical makeup of the sample. The blank should be yellow.

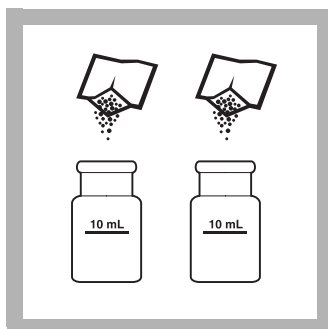

10. When the timer expires, add the contents of one EDTA Reagent Powder Pillow to each cell.

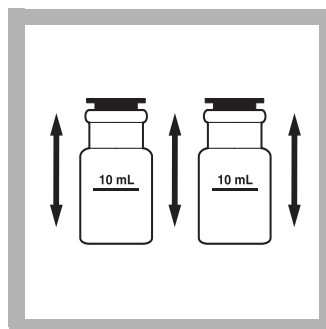

11. Stopper the cells and shake to dissolve.



12. Wipe the blank and insert it into the cell holder with the fill line facing right.

**13. Press ZERO.**

The display will show:

0.000 mg/L Ni

The instrument will zero at 560 and 620 nm.

14. Wipe the sample cell and insert it into the cell holder with the fill line facing right.

The instrument will read the sample at 560 and 620 nm.

Results are in mg/L Ni.

15. Press READ. The instrument will read the sample at 560 and 620 nm.

Results are in mg/L Ni and mg/L Co.

Interferences

Table 1 Interfering Substances and Levels

Interfering Substance	Interference Levels and Treatments
Al ³⁺	32 mg/L
Ca ²⁺	1000 mg/L as (CaCO ₃)
Cd ²⁺	20 mg/L
Cl ⁻	8000 mg/L
Chelating agents	Interfere at all levels. Use either the Digesdahl or vigorous digestion to eliminate this interference.
Cr ³⁺	20 mg/L
Cr ⁶⁺	40 mg/L
Cu ²⁺	15 mg/L
F ⁻	20 mg/L
Fe ³⁺	10 mg/L
Fe ²⁺	Interferes directly and must not be present.
K ⁺	500 mg/L
Mg ²⁺	400 mg/L
Mn ²⁺	25 mg/L
Mo ⁶⁺	60 mg/L
Na ⁺	5000 mg/L
Pb ²⁺	20 mg/L
Zn ²⁺	30 mg/L
Highly buffered samples or extreme sample pH	May exceed the buffering capacity of the reagents and require sample pretreatment.

Sample Collection, Storage, and Preservation

Collect samples in acid-washed plastic bottles. Adjust the sample pH to 2 or less with Nitric Acid*, about 5 mL per liter. Preserved samples can be stored up to six months at room temperature. Before analysis, adjust the sample pH to between 3 and 8 with 5.0 N Sodium Hydroxide Standard Solution*. If the sample is less than 10 °C, warm it to room temperature.

Do not exceed pH 8 as this may cause some loss of nickel as a precipitate. Correct test results for volume additions.

Accuracy Check

Standard Additions Method (Sample Spike)

1. After reading test results, leave the sample cell (unspiked sample) in the instrument.
2. Press **OPTIONS>MORE**. Press **STANDARD ADDITIONS**. A summary of the standard additions procedure will appear.
3. Press **OK** to accept the default values for standard concentration, sample volume, and spike volumes. Press **EDIT** to change these values. After values are accepted, the unspiked sample reading will appear in the top row. See the user manual for more information.
4. Snap the neck off a Nickel Voluette® Ampule Standard, 50-mg/L Ni.
5. Prepare three sample spikes. Fill three Mixing Cylinders* with 25 mL of sample. Use the TenSette® Pipet to add 0.1 mL, 0.2 mL, and 0.3 mL of standard, respectively, to each sample and mix thoroughly.
6. Transfer 10 mL of each solution into a 10-mL sample cell and analyze as described in the procedure. Accept each standard additions reading by pressing **READ**. Each addition should reflect approximately 100% recovery.
7. After completing the sequence, press **GRAPH** to view the best-fit line through the standard additions data points, accounting for the matrix interferences. Press **IDEAL LINE** to view the relationship between the sample spikes and the "Ideal Line" of 100% recovery.

Standard Solution Method

1. Prepare a 5.00-mg/L Nickel stock solution by pipetting 5.00 mL of Nickel Standard Solution, 1000-mg/L as Ni, into a 1-L volumetric flask. Dilute to the mark with deionized water. Prepare this solution daily.
2. Prepare a 0.5-mg/L Ni working solution by pipetting 10.0 mL of the 5.00-mg/L nickel stock solution into a 100-mL volumetric flask. Dilute to the mark with deionized water. Prepare this solution daily. Perform the nickel procedure as described above.
3. To adjust the calibration curve using the reading obtained with the standard solution, press **OPTIONS>MORE** on the current program menu. Press **STANDARD ADJUST**.
4. Press **ON**. Press **ADJUST** to accept the displayed concentration. If an alternate concentration is used, press the number in the box to enter the actual concentration, then press **OK**. Press **ADJUST**.

* See [Optional Reagents and Apparatus on page 5](#).

Summary of Method

After buffering the sample and masking any Fe^{3+} with pyrophosphate, the nickel is reacted with 1-(2-Pyridylazo)-2-Naphthol indicator. The indicator forms complexes with most metals present. After color development, EDTA is added to destroy all metal-PAN complexes except nickel and cobalt. The instrument automatically adjusts for cobalt interference by measuring the absorbance of the sample at both 560 nm and 620 nm. This method is unique because both nickel and cobalt can be determined on the same sample.

Consumables and Replacement Items

Required Reagents

Description	Quantity/Test	Unit	Cat. No.
Nickel Reagent Set (100 Tests), includes:	—	—	26516-00
(2) EDTA Reagent Powder Pillows	2	100/pkg	7005-99
(2) Phthalate-Phosphate Reagent Powder Pillows	2	100/pkg	26151-99
(1) PAN Indicator Solution, 0.3%	1 mL	100 mL MDB	21502-32
Water, deionized	25 mL	4 L	272-56

Required Apparatus

Description	Quantity/Test	Unit	Cat. No.
Sample Cells, 1-inch square glass, 10 mL, matched pair	2	2/pkg	24954-02
Stoppers	2	6/pkg	1731-06

Recommended Standards

Description	Unit	Cat. No.
Nickel Standard Solution, 1000-mg/L Ni (NIST)	100 mL	14176-42
Nickel Standard Solution, 50-mg/L Ni (NIST), 10-mL ampules	16/pkg	25576-10

Optional Reagents and Apparatus

Description	Cat. No.
Cylinder, mixing	1896-40
Nitric Acid 1:1	2540-49
Sodium Hydroxide Standard Solution, 5.0 N	2450-32



FOR TECHNICAL ASSISTANCE, PRICE INFORMATION AND ORDERING:

In the U.S.A. – Call toll-free 800-227-4224
Outside the U.S.A. – Contact the HACH office or distributor serving you.
On the Worldwide Web – www.hach.com; E-mail – techhelp@hach.com

HACH COMPANY
WORLD HEADQUARTERS
Telephone: (970) 669-3050
FAX: (970) 669-2932

★ Method 8037

Heptoxime Method¹

Powder Pillows

(0.02 to 1.80 mg/L Ni)

Scope and Application: For water, wastewater, and seawater; USEPA accepted for reporting wastewater analyses (digestion required)²

¹ Adapted from *Chimie Analytique*, 36 43 (1954)

² Procedure is equivalent to Standard Method 3500-Ni D for wastewater



Test Preparation

Before starting the test:

For more accurate results, determine a reagent blank value for each new lot of reagent. Follow the procedure using deionized water in place of the sample. Subtract the reagent blank value from the final results or perform a reagent blank adjust.

Make the cotton plug pea-size. A larger plug will restrict the flow; a smaller plug may become dislodged from the delivery tube of the funnel.

Chloroform (D022) solutions are regulated as hazardous waste by the Federal RCRA. Do not pour these materials down the drain. Water saturated with chloroform, chloroform solutions, and the cotton plug used in the delivery tube of the separatory funnel should be collected for disposal with laboratory solvent wastes. Refer to a current MSDS for safe handling and disposal instructions.

In bright light conditions (e.g. direct sunlight) it may be necessary to close the cell compartment with the protective cover during measurements.

Collect the following items:

Quantity

Chloroform, ACS	30 mL
Nickel 1 Reagent Powder Pillow	1
Nickel 2 Reagent Powder Pillow	1
Clippers for Opening Pillows	1
Cotton Balls	varies
Cylinder, graduated, 10-mL	1
Cylinder, graduated, 500-mL	1
Funnel, separatory with stand and stopper	1
Sample Cells, 1-inch square, 25-mL	2

Note: Reorder information for consumables and replacement items is on page 6.

Powder Pillows

Method 8037



1. Press **STORED PROGRAMS**.

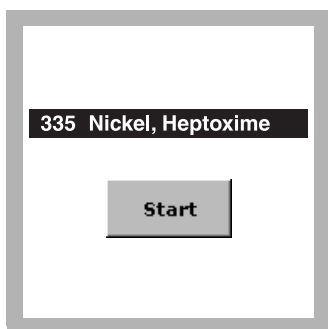

2. Select the test.



3. Measure 300 mL of sample in a 500-mL graduated cylinder. Pour into a 500-mL separatory funnel.

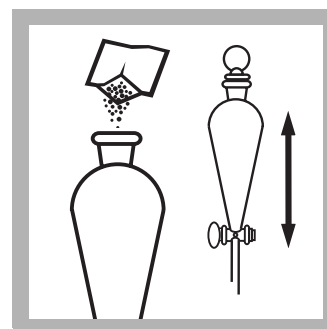

4. Add the contents of one Nickel 1 Reagent Powder Pillow to the funnel. Stopper and invert to mix.

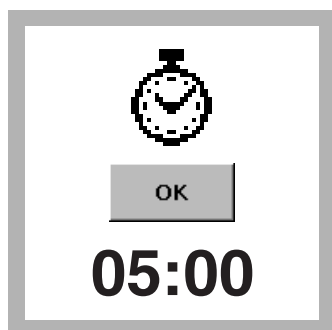

5. Press **TIMER>OK**.
A five-minute reaction period will begin.

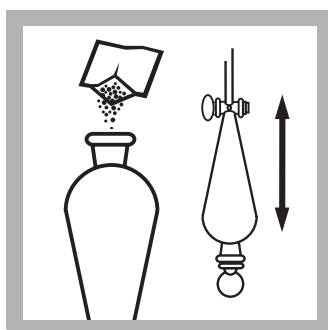

6. When the timer expires, add the contents of one Nickel 2 Reagent Powder Pillow to the funnel. Stopper and invert to mix.

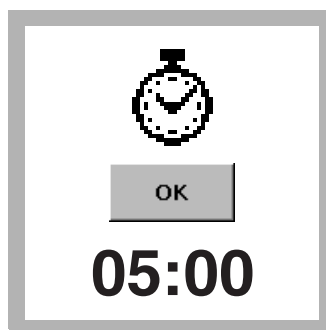

7. Press **TIMER>OK**.
A second five-minute reaction period will begin.

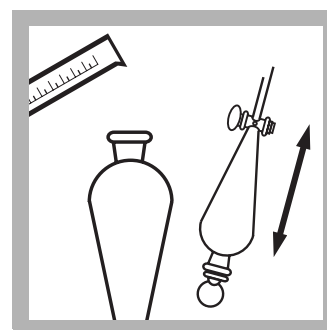

8. When the timer expires, add 10 mL of chloroform. Stopper and invert gently. With the funnel inverted and the tip pointed away from people, open the stopcock to vent.

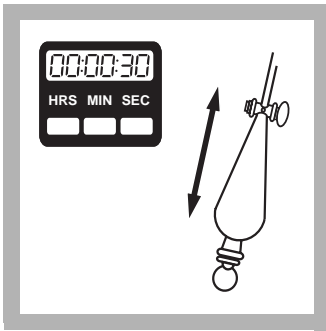

9. Close the stopcock and invert for 30 seconds.



10. Press **TIMER>OK**.
A third five-minute reaction period will begin. Invert the funnel several times over the five minute period.

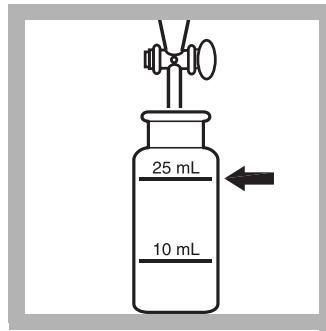

11. **Prepared Sample:**
When the timer expires, wait for the layers to separate. Insert a pea-sized cotton plug into the delivery tube of the funnel. Remove the stopper and drain the chloroform layer (bottom layer) into a 25-mL square sample cell.

Stopper the funnel.

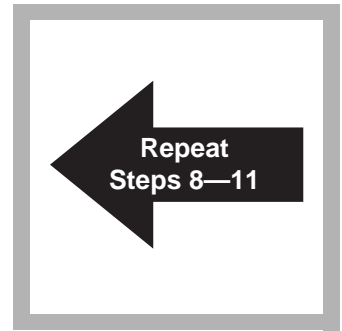

12. Repeat steps 8 through 11 two additional times with 10-mL volumes of chloroform. The five-minute reaction period is not necessary.

Stopper the funnel and invert to mix. Wait for the layers to separate, and continue.

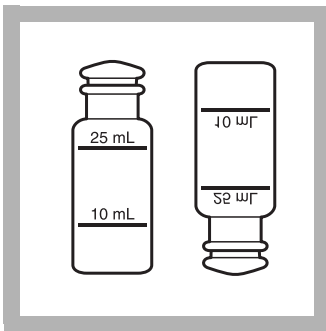

13. Cap the sample cell and invert to mix the extracts. The final volume will be about 25 mL due to the slight solubility of chloroform in water.

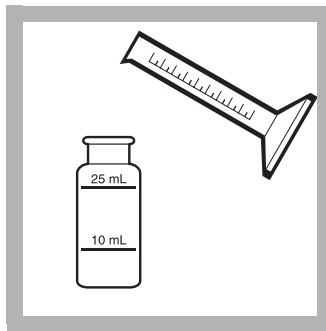

14. **Blank Preparation:**
Fill a second square sample cell with 25 mL of chloroform.
Cap the cell.

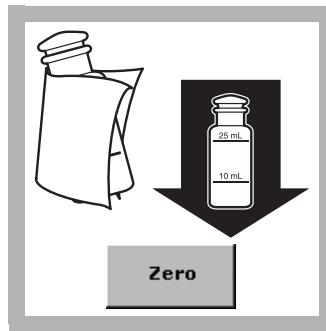

15. Wipe the blank and insert it into the cell holder with the fill line facing right. Press **ZERO**.

The display will show:

0.00 mg/L Ni

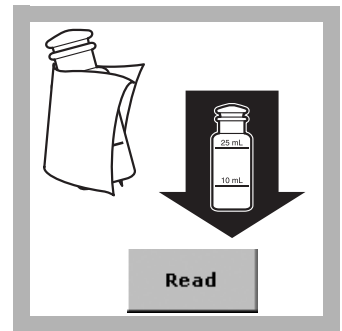

16. Wipe the prepared sample and insert it into the cell holder with the fill line facing right.

Results are in mg/L Ni.

Interferences

Cobalt, copper, and iron interferences can be overcome by adding additional Nickel 1 Reagent Powder Pillows in step 4. The tolerance limits of these interferences are shown in [Table 1](#).

Table 1 Interfering Substances

Pillows of Nickel 1 Reagent	Tolerance Limit (mg/L):		
	Cobalt	Copper	Iron
1	1	10	20
2	7	16	65
3	13	22	110
4	18	28	155
5	25	35	200

A preliminary acid digestion is required to determine any suspended or precipitated nickel and to eliminate interference by organic matter. To eliminate this interference or to determine total recoverable nickel perform the USEPA approved digestion.

Sample Collection, Storage, and Preservation

Collect samples in acid-washed plastic bottles. Adjust the sample pH to 2 or less with Nitric Acid*, about 5 mL per liter. Preserved samples can be stored up to six months at room temperature. Before analysis, adjust the sample pH to between 3–8 with 5.0 N Sodium Hydroxide Standard Solution*. Do not exceed pH 8 as this may cause some loss of nickel as a precipitate. Correct the test results for volume additions.

Accuracy Check

Standard Additions Method (Sample Spike)

1. After reading test results, leave the sample cell (unspiked sample) in the instrument.
2. Press **OPTIONS>MORE**. Press **STANDARD ADDITIONS**. A summary of the standard additions procedure will appear.
3. Press **OK** to accept the default values for standard concentration, sample volume, and spike volumes. Press **EDIT** to change these values. After values are accepted, the unspiked sample reading will appear in the top row. See the user manual for more information.
4. Snap the neck off a Nickel Voluette® Ampule Standard, 300-mg/L Ni.
5. Prepare three sample spikes. Use the TenSette® Pipet to add 0.2 mL, 0.4 mL, and 0.6 mL of standard, respectively, to three 300-mL samples and mix thoroughly.
6. Analyze as described in the procedure. Accept each standard additions reading by pressing **READ**. Each addition should reflect approximately 100% recovery.
7. After completing the sequence, press **GRAPH** to view the best-fit line through the standard additions data points, accounting for the matrix interferences. Press **IDEAL LINE** to view the relationship between the sample spikes and the “Ideal Line” of 100% recovery.

* See [Optional Reagents and Apparatus on page 6](#).

Standard Solutions Method

1. Prepare a 10.0-mg/L nickel working standard solution by pipetting 10.0 mL of a Nickel Standard Solution, 1000-mg/L, into a 1000-mL volumetric flask. Dilute to the mark with deionized water. Prepare this solution daily. Prepare a 1.0-mg/L nickel standard solution by diluting 50.0 mL of the 10-mg/L working standard solution to 500 mL in a volumetric flask. Perform the heptoxime procedure as described above.
2. To adjust the calibration curve using the reading obtained with the standard solution, press **OPTIONS>MORE** on the current program menu. Press **STANDARD ADJUST**.
3. Press **ON**. Press **ADJUST** to accept the displayed concentration. If an alternate concentration is used, press the number in the box to enter the actual concentration, then press **OK**. Press **ADJUST**.

Summary of Method

Nickel ion reacts with heptoxime to form a yellow-colored complex which is then extracted into chloroform to concentrate the color and enable a more sensitive determination. Chelating agents are added to the sample to overcome the interferences caused by cobalt, copper, and iron. Readings are taken at 430 nm.

Nickel (0.02 to 1.80 mg/L Ni)

Consumables and Replacement Items

Required Reagents

Description	Quantity/Test	Unit	Cat. No.
Nickel Reagent Set (50 Tests), includes:	—	—	22435-00
(3) Chloroform, ACS	30 mL	500 mL	14458-49
(2) Nickel 1 Reagent Powder Pillows	1	25/pkg	2123-68
(2) Nickel 2 Reagent Powder Pillows	1	25/pkg	2124-68

Required Apparatus

Description	Quantity/Test	Unit	Cat. No.
Clippers	1	each	968-00
Cotton Balls, absorbent	1	100/pkg	2572-01
Cylinder, graduated, 10-mL	1	each	508-38
Cylinder, graduated, 500-mL	1	each	508-49
Funnel, separatory, 500-mL	1	each	520-49
Ring, support, 4-inch	1	each	580-01
Sample Cells, 1-inch square glass, 25 mL, with cap	2	2/pkg	26126-02
Stand, support, 5 x 8-inch base	1	each	563-00

Recommended Standards

Description	Unit	Cat. No.
Nickel Standard Solution, 1000-mg/L Ni (NIST)	100 mL	14176-42
Nickel Standard Solution, 300-mg/L Ni (NIST), 10-mL Voluette® Ampules	16/pkg	14266-10
Water, deionized	4 L	272-56

Optional Reagents and Apparatus

Description	Cat. No.
Cylinder, mixing	1896-40
Nitric Acid 1:1	2540-49
Sodium Hydroxide Standard Solution, 5.0 N	2450-53



FOR TECHNICAL ASSISTANCE, PRICE INFORMATION AND ORDERING:
In the U.S.A. – Call toll-free 800-227-4224
Outside the U.S.A. – Contact the HACH office or distributor serving you.
On the Worldwide Web – www.hach.com; E-mail – techhelp@hach.com

HACH COMPANY
WORLD HEADQUARTERS
Telephone: (970) 669-3050
FAX: (970) 669-2932

Method 10220

Dimethylglyoxime Method

TNTplus™ 856

(0.1 to 6.0 mg/L Ni)

Scope and Application: For wastewater, drinking water and process analysis.



Test Preparation

Before starting the test:

Important Note: Install the light shield in Cell Compartment #2 before performing this test.

Please read Safety Advice and Expiration Date on package.

Recommended sample pH is 3–10.

Recommended sample and reagent temperature is 15–25 °C (59–77 °F).

Nickel concentration greater than the measuring range cause precipitation in the vial. In such cases, the water sample must first be diluted with deionized water.

Undissolved nickel or nickel contained in complexes can only be determined after digestion with Metals Prep Set TNT 890.

TNTplus methods are activated directly from the Main Menu when the sample vial is inserted into the sample cell holder.

Collect the following items:

Quantity

Light Shield	1
Nickel TNT856 Reagent Set	1
Pipettor, variable, 100–1000 µL	1
Pipettor tips, for 100–1000 µL pipettor	1
Pipettor, variable, 1–5 mL	1
Pipettor, tips for 1–5 mL pipettor	1

Note: Reorder information for consumables and replacement items is on page 4.

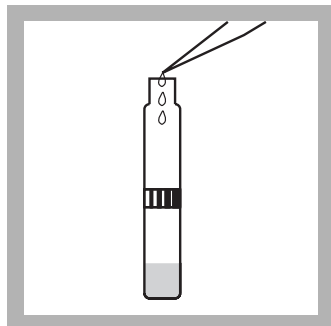

1. Pipet 2.0 mL of sample into the vial.

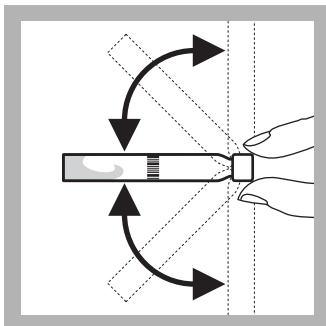

2. Cap the vial and invert 2–3 times until the freeze-dried contents in the vial are completely dissolved.

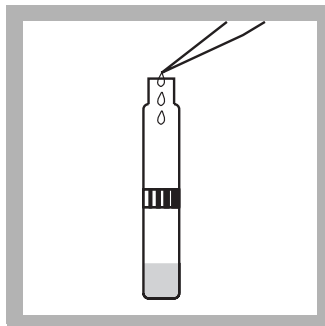

3. Pipet 0.2 mL (200 μ L) of Solution A into the vial.

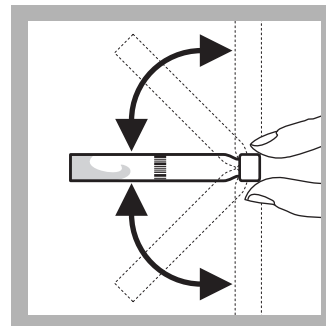

4. Cap and invert the vial 2–3 times.



5. Wait three minutes.
Install the Light Shield in Cell Compartment #2.



6. Thoroughly clean the outside of the vial. Insert the prepared vial into the cell holder. The instrument reads the barcode, then selects and performs the correct test.

Results are in mg/L Ni

No instrument zero is required.

Reagent Blanks

A reagent blank can be measured, and the value subtracted from the results of each test performed using the same reagent lot number. Use deionized water in place of sample and run the procedure as described.

To subtract the value of the blank from a series of measurements, measure the blank per step 6. Press **OPTIONS>MORE>REAGENT BLANK**. Select **ON**. The measured value of the blank should be displayed in the highlighted box. Press **OK** to accept this value. The reagent blank value will now be subtracted from all results until the function is turned off, or a different method is selected. Alternately, the blank can be recorded and entered at any later time by pressing the highlighted box and using the keypad to enter the value.

Sample Blanks

Colored or turbid samples can cause high results. To compensate for color or turbidity the procedure is repeated and the color forming reagent that is present in Solution A is not added.

To determine the sample blank run the procedure as given, but substitute 0.2 mL of deionized water in place of the 0.2 mL of Solution A in step 3. Use the red stopper to cap the sample vial. The value obtained in step 6 is then subtracted from the value obtained on the original sample to give the corrected sample concentration.

Alternatively, samples that contain only turbidity may be first filtered through a membrane filter and then analyzed. Report the results as soluble nickel.

Samples without color or turbidity do not require sample blanks.

Interferences

The ions listed in [Table 1](#) have been individually checked up to the given concentrations and do not cause interference. The cumulative effects and influence of other ions has not been determined. Undissolved nickel or nickel contained in complexes can only be determined after digestion with Metals Prep Set TNT 890.

Table 1 Interfering Substances and Levels

Interfering Substance	Interference Levels
K ⁺ , Na ⁺ , Cl ⁻ , SO ₄ ²⁻	1000 mg/L
NH ₄ ⁺ , NO ₃ ⁻ , Ca ²⁺ , PO ₄ ³⁻ , CO ₃ ²⁻	500 mg/L
Cr ⁶⁺ , Zn ²⁺ , F ⁻ , NO ₂ ⁻	50 mg/L
Al ³⁺ , Cr ³⁺ , Cd ²⁺ , Co ²⁺ , Sn ²⁺ , Pb ²⁺	10 mg/L
Fe ²⁺ , Fe ³⁺ , Mn ²⁺ , Cu ²⁺ , Mg ²⁺ , Hg ²⁺	5 mg/L
Ag ⁺	1 mg/L

Sample Collection, Preservation, and Storage

Collect samples in an acid-washed glass or plastic containers. Adjust the pH to 2 or less with nitric acid (about 2 mL per liter). Store preserved samples up to six months at room temperature. Adjust the pH between 3–10 with 5.0 N sodium hydroxide before analysis. Correct the test result for volume additions.

Accuracy Check

Standard Solution Method

To check the accuracy of the method prepare a 4.0 mg/L nickel standard solution by pipetting 1.0 mL of a 1000 mg/L nickel standard solution into a 250 mL volumetric flask. Dilute to volume with deionized water. Prepare this solution daily. Use 2.0 mL of this standard in place of the sample in the procedure.

Summary of Method

In the presence of an oxidizing agent, nickel ions react with dimethylglyoxime in an alkaline solution to form an orange-brown-colored complex. Test results are measured at 463 nm.

Consumables and Replacement Items**Required Reagents**

Description	Quantity/Test	Unit	Cat. No.
Nickel TNT 856 Reagent Set	1	25/pkg	TNT856

Required Apparatus

Description	Quantity/Test	Unit	Cat. No.
Light Shield	1	each	LZV646
Pipettor, variable volume, 1–5 mL	1	each	27951-00
Pipettor Tips, for 27951-00 pipettor	1	100/pkg	27952-00
Pipettor, variable volume, 100–1000 µL	1	each	27949-00
Pipettor Tips, for 27949-00 pipettor	1	400/pkg	27950-00

Recommended Reagents and Standards

Description	Unit	Cat. No.
Nickel Standard Solution, 1000 mg/L	100 mL	14176-42
Nitric Acid, ACS	500 mL	152-49
Sodium Hydroxide Standard Solution, 5.0 N	100 mL MDB	2450-32
Sodium Hydroxide Standard Solution, 5.0 N	59 mL SCDB	2450-26
Water, deionized	4 L	272-56

Optional Reagents and Apparatus

Description	Unit	Cat. No.
Bottle, sampling, low density poly, w/cap, 500 mL	12/pkg	20870-79
Filter Holder, glass for vacuum filtration (SUVA)	each	2340-00
Filter, membrane, 47-00; 0.45 -micron, hydrophilic, polyethersulfone for SUVA	each	28947-00
Flask, filtering, glass, 1000-mL (SUVA)	each	546-53
Flask, volumetric 250 mL	each	14574-46
Pipet, volumetric 1.0 mL	each	14515-35
Metals Prep Set TNT 890	each	TNT890
Test Tube Rack for 13-mm vials	each	24979-00
Tubing, rubber	12 ft	560-19



FOR TECHNICAL ASSISTANCE, PRICE INFORMATION AND ORDERING:
In the U.S.A. – Call toll-free 800-227-4224
Outside the U.S.A. – Contact the HACH office or distributor serving you.
On the Worldwide Web – www.hach.com; E-mail – techhelp@hach.com

HACH COMPANY
WORLD HEADQUARTERS
Telephone: (970) 669-3050
FAX: (970) 669-2932

Nitrate

Method 8039

Cadmium Reduction Method

Powder Pillows or AccuVac® Ampuls

HR (0.3 to 30.0 mg/L NO₃⁻-N)

Scope and Application: For water, wastewater, and seawater.



Test Preparation

Before starting the test:

For more accurate results, determine a reagent blank value for each new lot of reagent. Follow the procedure using deionized water instead of the sample. Subtract the reagent blank value from the final results or perform a reagent blank adjust.

A deposit of unoxidized metal will remain after the NitraVer® 5 dissolves. The deposit will not affect results.

This method is technique-sensitive. Shaking time and technique influence color development. For most accurate results, make successive tests on a 10-mg/L Nitrate Nitrogen Standard solution. Adjust shaking time and technique to obtain the correct result.

Rinse the sample cell immediately after use to remove all cadmium particles. Prepared samples will contain cadmium and must be disposed of according to Federal, State, and local hazardous waste regulations. Refer to the current MSDS for safe handling and disposal instructions.

Collect the following items:

Quantity

Collect the following items:	Quantity
Powder Pillow Test:	
NitraVer® 5 Nitrate Reagent Powder Pillow	1
Sample Cells, 1-inch square, 10-mL, with stopper	2
AccuVac Test:	
NitraVer® 5 Nitrate Reagent AccuVac® Ampul	1
Beaker, 50-mL	1
Sample Cell, 10-mL round, with cap	1

Note: Reorder information for consumables and replacement items is on page 6.

Powder Pillows

Method 8039



1. Press **STORED PROGRAMS**.

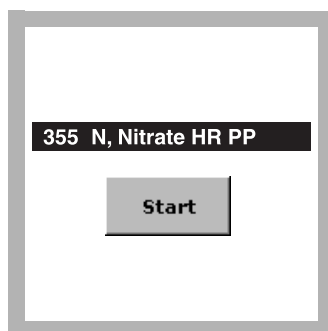

2. Select the test.

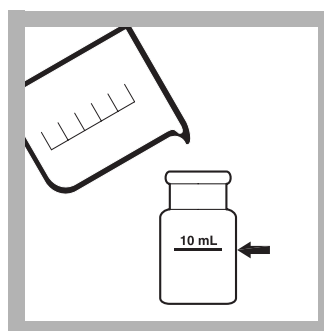

3. Fill a square sample cell with 10 mL of sample.

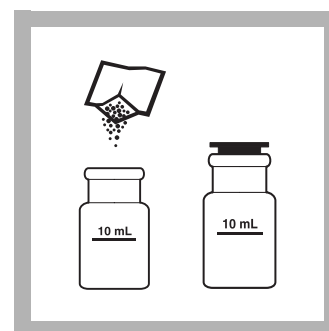

4. **Prepared Sample:** Add the contents of one NitraVer 5 Nitrate Reagent Powder Pillow. Stopper.

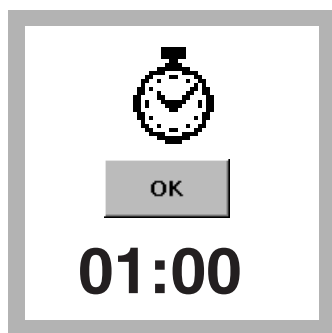

5. Press **TIMER>OK**.
A one-minute reaction period will begin.

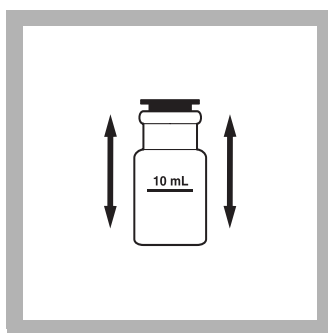

6. Shake the cell vigorously until the timer expires.

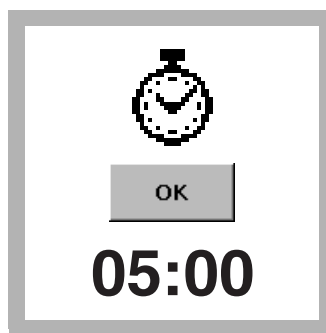

7. When the timer expires, press **TIMER>OK** again. A five-minute reaction period will begin.

An amber color will develop if nitrate is present.

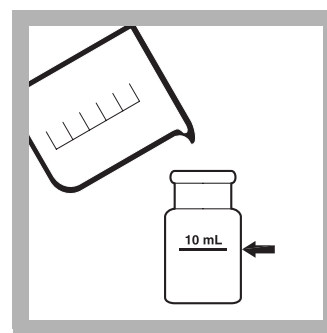

8. **Blank Preparation:** When the timer expires, fill a second square sample cell with 10 mL of sample.



9. Wipe the blank and insert it into the cell holder with the fill line facing right.

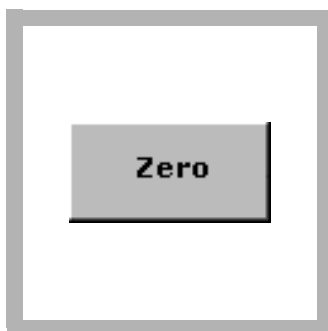

10. Press **ZERO**.
The display will show:
0.0 mg/L NO₃⁻-N



11. Within one minute after the timer expires, wipe the prepared sample and insert it into the cell holder with the fill line facing right.

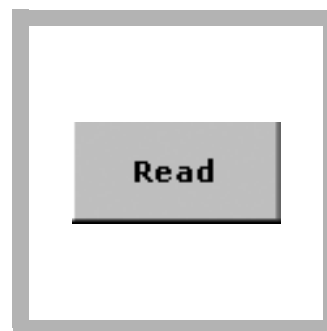

12. Press **READ**.
Results are in mg/L NO₃⁻-N.

AccuVac® Ampul

Method 8039

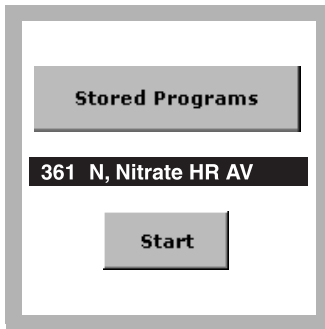

1. Select the test

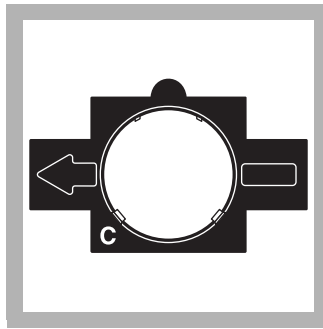

2. Insert Adapter C.

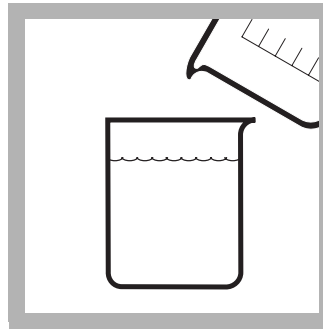

3. **Prepared Sample:**
Collect at least 40 mL of sample in a 50-mL beaker.

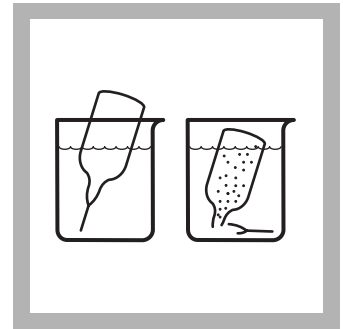

4. Tap the bottom of a NitraVer 5 Nitrate AccuVac® Ampul on a hard surface to dislodge powder. Fill the Ampul with sample. Keep the tip immersed while the Ampul fills completely. Insert a stopper over the Ampul tip.



5. Press **TIMER>OK**.
A one-minute reaction period will begin.

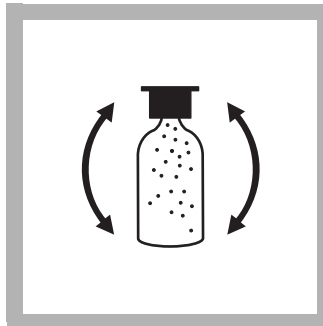

6. Invert the Ampul a full rotation once per second until the timer expires.

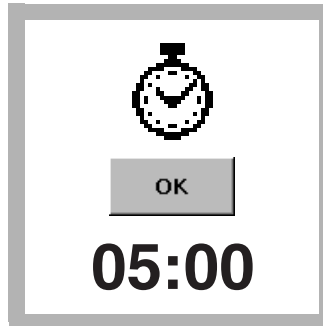

7. When the timer expires, press **TIMER>OK** again. A five-minute reaction period will begin. Do not agitate or disturb the sample during this time.

An amber color will develop if nitrate is present.



8. **Blank Preparation:**
When the timer expires, fill a round sample cell with 10 mL of sample.

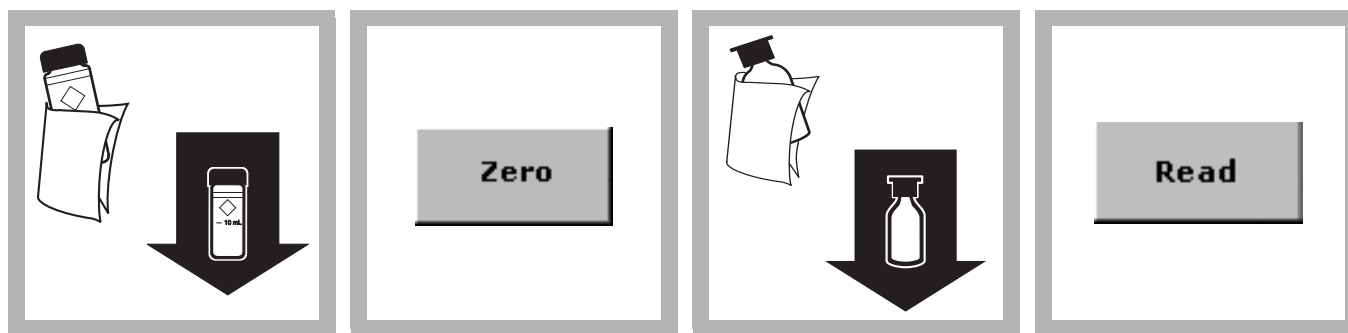

9. Wipe the blank and insert it into the cell holder.

10. Press **ZERO**.
The display will show:
0.0 mg/L NO₃⁻-N

11. Within one minute after the timer expires, wipe the Ampul and insert into the cell holder.

12. Press **READ**.
Results are in mg/L NO₃⁻-N.

Interferences

Table 1 Interfering Substances and Levels

Interfering Substance	Interference Levels and Treatments
Chloride	Chloride concentrations above 100 mg/L will cause low results. The test may be used at high chloride concentrations (seawater) but a calibration must be done using standards spiked to the same chloride concentration.
Ferric iron	Interferes at all levels
Nitrite	Interferes at all levels Compensate for nitrite interference as follows: Before performing <i>step 3</i> , add 30-g/L Bromine Water ¹ dropwise to the sample until a yellow color remains. Add one drop of 30-g/L Phenol Solution ¹ to destroy the color. Proceed with <i>step 3</i> . Report the results as total nitrate and nitrite.
pH	Highly buffered samples or extreme sample pH may exceed the buffering capacity of the reagents and require sample pretreatment.
Strong oxidizing and reducing substances	Interfere at all levels

¹ See [Optional Reagents and Apparatus on page 6](#).

Sample Collection, Storage, and Preservation

More reliable results are obtained when samples are analyzed as soon as possible after collection. If prompt analysis is impossible, store samples in clean plastic or glass bottles for up to 24 hours at 4 °C. To preserve samples for longer periods, add 2 mL of Concentrated Sulfuric Acid (H₂SO₄)* per liter and store at 4 °C.

Before analysis, warm the sample to room temperature and adjust the pH to 7 with 5.0 N Sodium Hydroxide Standard Solution*. Do not use mercury compounds as preservatives. Correct the test result for volume additions by dividing the total volume (acid + base + sample) by the original sample volume and multiplying the test result by this factor.

* See [Optional Reagents and Apparatus on page 6](#).

Accuracy Check

Standard Additions Method (Sample Spike)

1. After reading test results, leave the sample cell (unspiked sample) in the instrument. Verify the chemical form.
2. Press **OPTIONS>MORE**. Press **STANDARD ADDITIONS**. A summary of the standard additions procedure will appear.
3. Press **OK** to accept the default values for standard concentration, sample volume, and spike volumes. Press **EDIT** to change these values. After values are accepted, the unspiked sample reading will appear in the top row. See the user manual for more information.
4. Snap the neck off a Nitrate Nitrogen Voluette® Ampule Standard, 250-mg/L NO₃⁻-N.
5. Prepare three sample spikes. Fill three sample cells* with 10 mL of sample. Use the TenSette® Pipet to add 0.1 mL, 0.2 mL, and 0.3 mL of standard, respectively, to each sample and mix thoroughly.
6. Analyze each sample spike as described in the procedure above, starting with the 0.1 mL sample spike. Accept each standard additions reading by pressing **READ**. Each addition should reflect approximately 100% recovery.

Note: For AccuVac® Ampuls, fill three mixing cylinders* with 50 mL of sample and spike with 0.4 mL, 0.8 mL, and 1.2 mL of standard. Transfer 40 mL from each of the three mixing cylinders to three 50-mL beakers*. Analyze each standard addition sample as described in the procedure above. Accept each standard additions reading by pressing **READ**. Each addition should reflect approximately 100% recovery.

7. After completing the sequence, press **GRAPH** to view the best-fit line through the standard additions data points, accounting for the matrix interferences. Press **IDEAL LINE** to view the relationship between the sample spikes and the "Ideal Line" of 100% recovery.

Standard Solution Method

1. To test accuracy, use a 10.0-mg/L Nitrate Nitrogen Standard Solution in place of the sample and perform the procedure as described above.
2. To adjust the calibration curve using the reading obtained with the standard solution, press **OPTIONS>MORE** on the current program menu. Press **STANDARD ADJUST**.
3. Press **ON**. Press **ADJUST** to accept the displayed concentration (the value depends on the selected chemical forms). If an alternate concentration is used, press the number in the box to enter the actual concentration, then press **OK**. Press **ADJUST**.

Summary of Method

Cadmium metal reduces nitrates in the sample to nitrite. The nitrite ion reacts in an acidic medium with sulfanilic acid to form an intermediate diazonium salt. The salt couples with gentisic acid to form an amber colored solution. Test results are measured at 500 nm.

* See [Optional Reagents and Apparatus on page 6](#).

Consumables and Replacement Items

Required Reagents

Description	Quantity/Test	Unit	Cat. No.
NitraVer® 5 Nitrate Reagent Powder Pillows (for 10-mL sample)	1	100/pkg	21061-69
OR			
NitraVer® 5 Nitrate Reagent AccuVac® Ampul	1	25/pkg	25110-25

Required Apparatus (Powder Pillows)

Description	Quantity/Test	Unit	Cat. No.
Sample Cells, 1-inch square, 10 mL, matched pair	2	2/pkg	24954-02
Stopper, Neoprene, solid, size #2	2	12/pkg	14808-02

Required Apparatus (AccuVac)

Description	Quantity/Test	Unit	Cat. No.
Adapter, 1-inch round, for AccuVac Ampuls	1	each	LZV584
Beaker, 50-mL	1	each	500-41H
Sample Cell, 10-mL, with cap	1	each	21228-00

Recommended Standards and Apparatus

Description	Unit	Cat. No.
Nitrate Nitrogen Standard Solution, 10.0-mg/L NO ₃ ⁻ -N	500 mL	307-49
Nitrate Nitrogen Standard Solution Ampule, 250-mg/L NO ₃ ⁻ -N	16/pkg	25577-10
Pipet, TenSette®, 0.1 to 1.0 mL	each	19700-01
Pipet Tips, for TenSette Pipet 19700-01	50/pkg	21856-96
Pipet Tips, for TenSette Pipet 19700-01	1000/pkg	21856-28
Wastewater Influent Standard, Mixed Parameter, for NH ₃ -N, NO ₃ -N, PO ₄ , COD, SO ₄ , TOC	500 mL	28331-49
Water, deionized	4 L	272-56

Optional Reagents and Apparatus

Description	Cat. No.
Bromine Water	2211-20
Cylinder, mixing, 50 mL	20886-41
Phenol Solution	2112-20
Sodium Hydroxide Standard Solution, 5.0 N	2450-26
Sulfuric Acid, concentrated	979-49



FOR TECHNICAL ASSISTANCE, PRICE INFORMATION AND ORDERING:
 In the U.S.A. – Call toll-free 800-227-4224
 Outside the U.S.A. – Contact the HACH office or distributor serving you.
 On the Worldwide Web – www.hach.com; E-mail – techhelp@hach.com

HACH COMPANY
 WORLD HEADQUARTERS
 Telephone: (970) 669-3050
 FAX: (970) 669-2932

Method 8192 Powder Pillows

Cadmium Reduction Method LR (0.01 to 0.50 mg/L NO₃⁻-N)

Scope and Application: For water, wastewater, and seawater



Test Preparation

Before starting the test:

For more accurate results, determine a reagent blank value for each new lot of reagent. Follow the procedure using deionized water in place of the sample. Subtract the reagent blank value from the final results or perform a reagent blank adjust.

A deposit of unoxidized metal will remain after the NitraVer® 6 dissolves. The deposit will not affect results.

Shaking time and technique influence color development. Analyze a standard solution several times and adjust the shaking time to obtain the correct result. Use this time for analyzing samples.

Rinse the sample cell and mixing cylinder immediately after use to remove all cadmium particles.

Properly dispose of the used sample. Prepared samples contain cadmium and must be disposed of according to Federal, State, and local hazardous waste regulations. Refer to the current MSDS for safe handling and disposal information.

Collect the following items:

Quantity

NitraVer® 6 Nitrate Reagent powder pillow	1
NitraVer® 3 Nitrite Reagent powder pillow	1
Cylinder, graduated, mixing, 25-mL	1
Sample Cells, 1-inch square, 10-mL	2

Note: Reorder information for consumables and replacement items is on page 5.

Powder Pillows

Method 8192



1. Press **STORED PROGRAMS**.



2. Select the test.

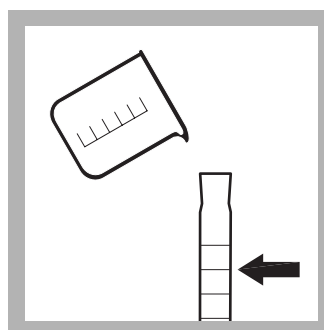

3. Fill a 25-mL graduated mixing cylinder with 15 mL of sample.

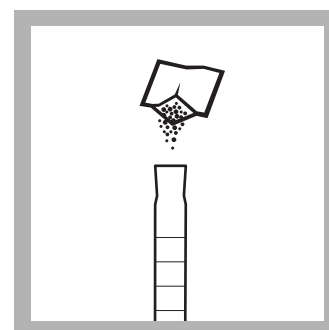

4. Add the contents of one NitraVer 6 Reagent Powder Pillow to the cylinder. Stopper.

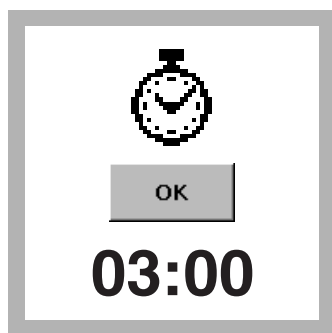

5. Press **TIMER>OK.**
A 3-minute reaction time will begin.

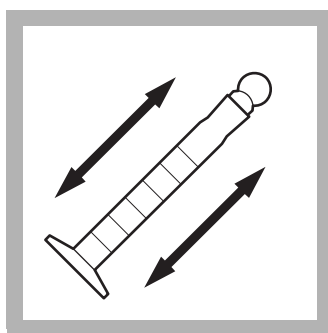

6. Shake the cylinder vigorously during the three-minute timer.

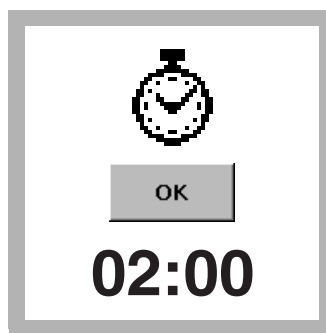

7. When the timer expires, press **TIMER>OK again.**
A 2-minute reaction period will begin.

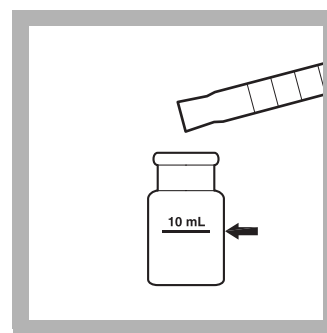

8. When the timer expires, carefully pour 10 mL of the sample into a clean square sample cell. Do not transfer any cadmium particles to the sample cell.

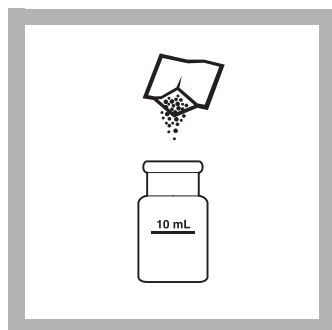

9. Prepared Sample:
Add the contents of one NitrVer 3 Nitrite Reagent Powder Pillow to the sample cell.

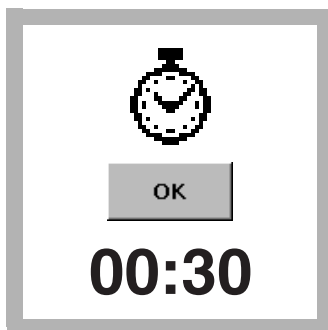

10. Press **TIMER>OK.**
A 30-second reaction time will begin.

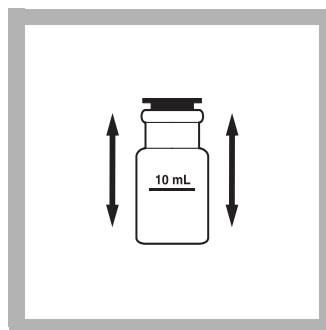

11. Cap and shake the sample cell gently during the 30-second timer.
A pink color will develop if nitrate is present.

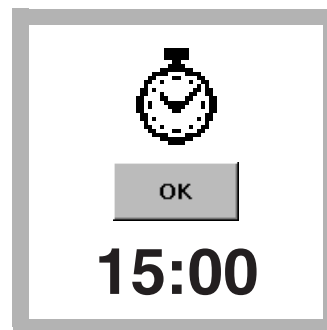

12. Press **TIMER>OK.**
A 15-minute reaction period will begin.

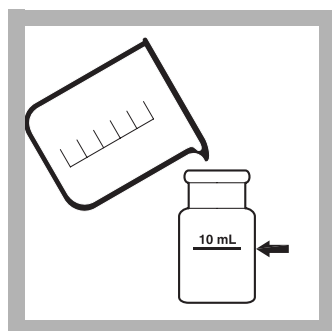

13. Blank Preparation:
When the timer expires, fill a second square sample cell with 10 mL of original sample.



14. Insert the blank into the cell holder with the fill line facing right.

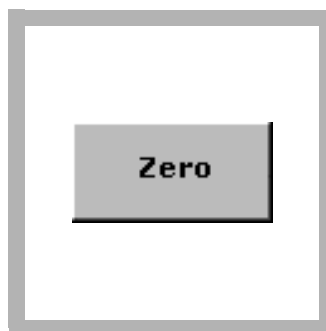

15. Press **ZERO.**
The display will show:
0.00 mg/L NO₃⁻-N

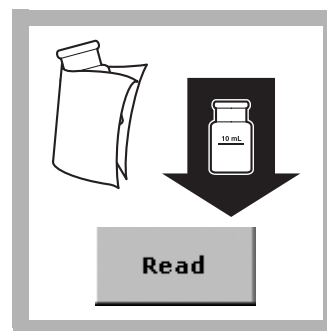

16. Insert the prepared sample into the cell holder with the fill line facing right.
Press **READ**. Results are in mg/L NO₃⁻-N.

Interferences

Table 1 Interfering Substances and Levels

Interfering Substance	Interference Levels and Treatments
Calcium	100 mg/L
Chloride	Chloride concentrations above 100 mg/L will cause low results. The test may be used at high chloride concentrations (seawater) but a calibration must be done using standards spiked to the same chloride concentration.
Ferric iron	All levels
Nitrite	All levels: This method measures both the nitrate and nitrite in the sample. If nitrite is present, the nitrite nitrogen test (Program #371) should be done on the sample. Pretreat the nitrate nitrogen sample with the following pretreatment. Then subtract the amount of nitrite found from the results of the LR nitrate nitrogen test. Add 30-g/L Bromine Water ¹ dropwise to the sample in step 4 until a yellow color remains. Mix after each drop. Add one drop of 30-g/L Phenol Solution ¹ to destroy the color. Proceed with the LR Nitrate procedure.
pH	Highly buffered samples or extreme sample pH may exceed the buffering capacity of the reagents and require sample pretreatment.
Strong oxidizing and reducing substances	Interferes at all levels

¹ See [Optional Reagents and Apparatus on page 5](#).

Sample Collection, Storage, and Preservation

More reliable results are obtained when samples are analyzed as soon as possible after collection. If prompt analysis is impossible, store samples in clean plastic or glass bottles for up to 48 hours at 4 °C. To preserve samples for longer periods, add 2 mL of Concentrated Sulfuric Acid* per liter and store at 4 °C.

Before analysis, warm the sample to room temperature and adjust the pH to 7 with 5.0 N Sodium Hydroxide Standard Solution*. Do not use mercury compounds as preservatives. Correct the test result for volume additions by dividing the total volume (acid + base + sample) by the original sample volume and multiplying the test result by this factor.

Accuracy Check

Standard Additions Method (Sample Spike)

1. After reading test results, leave the sample cell (unspiked sample) in the instrument. Verify the chemical form.
2. Press **OPTIONS>MORE**. Press **STANDARD ADDITIONS**. A summary of the standard additions procedure will appear.
3. Press **OK** to accept the default values for standard concentration, sample volume, and spike volumes. Press **EDIT** to change these values. After values are accepted, the unspiked sample reading will appear in the top row. See the user manual for more information.
4. Snap the neck off a Nitrate Nitrogen Voluette® Ampule Standard, 12.0-mg/L NO₃⁻-N*.

* See [Optional Reagents and Apparatus on page 5](#).

5. Prepare three sample spikes. Fill three mixing cylinders* with 15 mL of sample. Use the TenSette® Pipet to add 0.1 mL, 0.2 mL, and 0.3 mL of standard, respectively, to each sample and mix thoroughly.
6. Analyze each sample spike as described in the procedure above, starting with the 0.1 mL sample spike. Accept each standard additions reading by pressing **READ**. Each addition should reflect approximately 100% recovery.
7. After completing the sequence, press **GRAPH** to view the best-fit line through the standard additions data points, accounting for matrix interferences. Press **IDEAL LINE** to view relationships between the sample spikes and the "Ideal Line" of 100% recovery.

Standard Solution Method

1. To test accuracy, use a 0.40-mg/L NO₃⁻-N standard in place of the sample and perform the procedure as described. Prepare this standard by diluting 4.00 mL of a 10-mg/L Nitrate Nitrogen Standard Solution to 100.0 mL with deionized water.
2. To adjust the calibration curve using the reading obtained with the standard solution, press **OPTIONS>MORE** on the current program menu. Press **STANDARD ADJUST**.
3. Press **ON**. Press **ADJUST** to accept the displayed concentration. If an alternate concentration is used, press the number in the box to enter the actual concentration, then press **OK**. Press **ADJUST**.

Summary of Method

Cadmium metal reduces nitrates in the sample to nitrite. The nitrite ion reacts in an acidic medium with sulfanilic acid to form an intermediate diazonium salt. The salt couples with chromotropic acid to form a pink-colored product. Test results are measured at 507 nm.

* See [Optional Reagents and Apparatus on page 5](#).

Consumables and Replacement Items

Required Reagents

Description	Quantity/Test	Unit	Cat. No.
Low Range Nitrate Reagent Set (100 tests), includes:	—	—	24298-00
NitraVer® 6 Nitrate Reagent Powder Pillows	1	100/pkg	21072-49
NitriVer® 3 Nitrite Reagent Powder Pillows	1	100/pkg	21071-69

Required Apparatus

Description	Quantity/Test	Unit	Cat. No.
Cylinder, graduated mixing, 25-mL	1	each	20886-40
Sample Cells, 1-inch square, 10 mL, matched pair	2	2/pkg	24954-02

Recommended Standards and Apparatus

Description	Unit	Cat. No.
Flask, volumetric, Class A, 100-mL	each	14574-42
Nitrate Nitrogen Standard Solution, 10.0-mg/L NO ₃ ⁻ -N	500 mL	307-49
Nitrate Nitrogen Standard Solution, Voluette® Ampule, 12-mg/L NO ₃ ⁻ -N	16/pkg	14333-10
Pipet, TenSette®, 0.1–1.0 mL	each	19700-01
Pipet Tips, for TenSette Pipet 19700-01	50/pkg	21856-96
Pipet Tips, for TenSette Pipet 19700-01	1000/pkg	21856-28
Pipet, volumetric, Class A, 4.00 mL	each	14515-04
Water, deionized	4 L	272-56

Optional Reagents and Apparatus

Description	Cat. No.
Bromine Water, 30 g/L	2211-20
Phenol Solution, 30-g/L	2112-20
Sodium Hydroxide Standard Solution, 5.0 N	2450-53
Sulfuric Acid, concentrated	979-49



FOR TECHNICAL ASSISTANCE, PRICE INFORMATION AND ORDERING:

In the U.S.A. – Call toll-free 800-227-4224
Outside the U.S.A. – Contact the HACH office or distributor serving you.
On the Worldwide Web – www.hach.com; E-mail – techhelp@hach.com

HACH COMPANY
WORLD HEADQUARTERS
Telephone: (970) 669-3050
FAX: (970) 669-2932

Method 10020

Chromotropic Acid Method

Test 'N Tube™ Vials

HR (0.2 to 30.0 mg/L NO₃⁻-N)

Scope and Application: For water and wastewater



Test Preparation

Before starting the test:

Important Note: Install the light shield in Cell Compartment #2 before performing this test.

For more accurate results, determine a reagent blank value for each new lot of reagent. Follow the procedure using deionized water (nitrate-free) in place of the sample. Subtract the reagent blank value from the final results or perform a reagent blank adjust.

This test is technique-sensitive. Invert the vials as described here to avoid low results: Hold the vial in a vertical position with the cap pointing up. Turn the vial upside-down. Wait for all of the solution to flow down to the cap. Pause. Return the vial to an upright position. Wait for all the solution to flow to the bottom of the vial. This process equals one inversion.

Collect the following items:

Quantity

Test 'N Tube™ NitraVer® X Reagent Set	1
Funnel, micro, poly	1
Light Shield	1
Pipet, TenSette®, 0.01 to 1.0 mL, plus tips	1
Test Tube Rack	1-3

Note: Reorder information for consumables and replacement items is on page 4.

Test 'N Tube

Method 10020



1. Select the test.

Install the Light Shield in Cell Compartment #2.

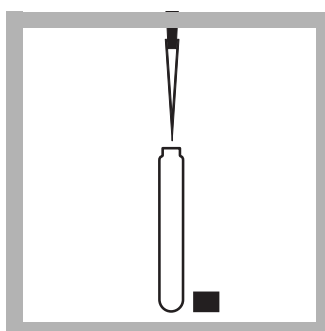

2. Blank Preparation:

Remove the cap from a NitraVer X Reagent A Test 'N Tube vial and add 1.00 mL of sample.

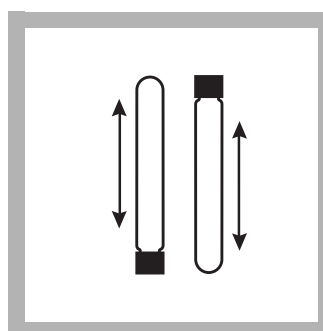

3. Cap the tube and invert ten times to mix.

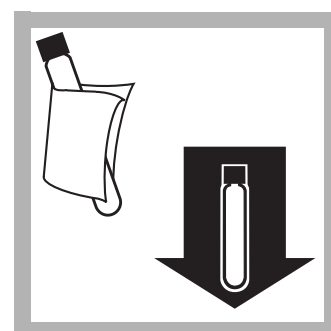

4. Wipe the blank and insert it into the 16 mm round cell holder.

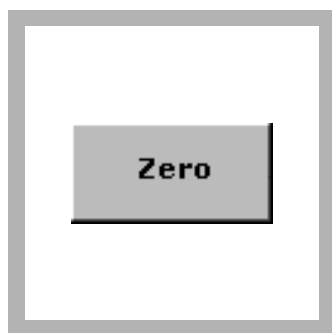

5. Press ZERO.
The display will show:
0.0 mg/L NO₃⁻-N

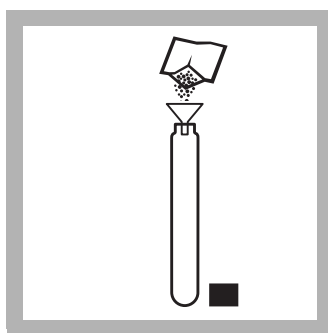

6. Prepared Sample:
Remove the vial from the instrument. Using a funnel, add the contents of one NitraVer X Reagent B Powder Pillow to the vial.

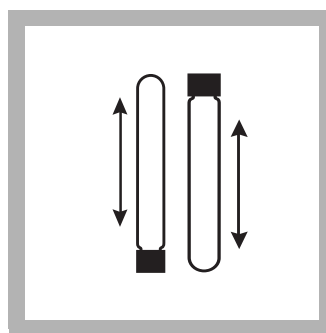

7. Cap and invert ten times to mix.
Some solid matter will not dissolve.

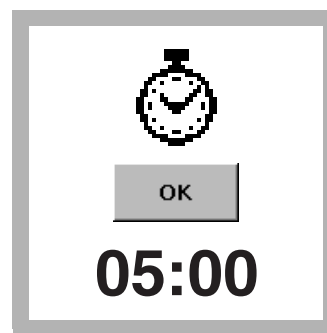

8. Press TIMER>OK.
A five-minute reaction period will begin. Do not invert the vial again.
A yellow color will develop if nitrate is present.

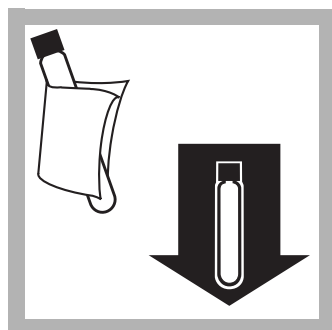

9. Within five minutes after the timer expires, wipe the prepared sample and insert it into the cell holder.

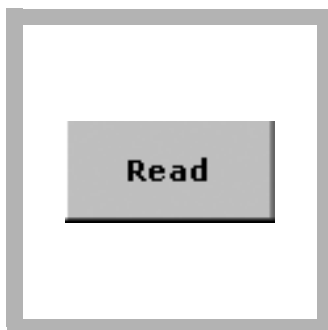

10. Press READ.
Results are in mg/L NO₃⁻-N.

Interferences

Table 1 Interfering Substances and Levels

Interfering Substance	Interference Levels and Treatments
Barium	A negative interference at concentrations greater than 1 mg/L.
Chloride	Does not interfere below 1000 mg/L.
Nitrite	A positive interference at concentrations greater than 12 mg/L. Remove nitrite interference up to 100 mg/L by adding 400 mg (one full 0.5 g measuring spoon) of Urea ¹ to 10 mL of sample. Swirl to dissolve. Proceed with the nitrate test as usual.
Copper	Positive at all levels.

¹ See [Optional Reagents and Apparatus on page 4](#).

Sample Collection, Preservation, and Storage

Collect samples in clean plastic or glass bottles. Store at 4 °C (39 °F) or lower if the sample is to be analyzed within 24 to 48 hours. Warm to room temperature before running the test. For longer storage periods (up to 14 days), adjust sample pH to 2 or less with Concentrated Sulfuric Acid, ACS* (about 2 mL per liter). Sample refrigeration is still required.

Before testing the stored sample, warm to room temperature and neutralize with 5.0 N Sodium Hydroxide Standard Solution*. Do not use mercury compounds as preservatives. Correct the test result for volume additions.

Accuracy Check

Standard Additions Method (Sample Spike)

1. After reading test results, leave the sample cell (unspiked sample) in the instrument. Verify the chemical form.
2. Press **OPTIONS>MORE**. Press **STANDARD ADDITIONS**. A summary of the standard additions procedure will appear.
3. Press **OK** to accept the default values for standard concentration, sample volume, and spike volumes. Press **EDIT** to change these values. After values are accepted, the unspiked sample reading will appear in the top row. See the user manual for more information.
4. Snap the neck off a High Range Nitrate Nitrogen Voluette® Ampule Standard, 500 mg/L NO₃⁻-N.
5. Prepare three sample spikes. Fill three mixing cylinders* with 25 mL of sample. Use the TenSette® Pipet to add 0.1 mL, 0.2 mL, and 0.3 mL of standard, respectively, to each sample and mix thoroughly.
6. Analyze each sample spike as described in the procedure above, starting with the 0.1 mL sample spike. Accept each standard additions reading by pressing **READ**. Each addition should reflect approximately 100% recovery.
7. After completing the sequence, press **GRAPH** to view the best-fit line through the standard additions data points, accounting for the matrix interferences. Press **IDEAL LINE** to view the relationship between the sample spikes and the "Ideal Line" of 100% recovery.

Standard Solution Method

1. To test accuracy, use a 10.0-mg/L Nitrate Nitrogen Standard Solution in place of the sample and perform the procedure as described above.
2. To adjust the calibration curve using the reading obtained with the 10.0-mg/L Nitrate Nitrogen Standard Solution, press **OPTIONS>MORE** on the current program menu. Press **STANDARD ADJUST**.
3. Press **ON**. Press **ADJUST** to accept the displayed concentration (the value depends on the selected chemical form). If an alternate concentration is used, press the number in the box to enter the actual concentration, then press **OK**. Press **ADJUST**.

* See [Optional Reagents and Apparatus on page 4](#).

Nitrate HR (0.2 to 30.0 mg/L NO₃⁻-N)

Summary of Method

Nitrate in the sample reacts with chromotropic acid under strongly acidic conditions to yield a yellow product with a maximum absorbance at 410 nm.

Consumables and Replacement Items

Required Reagents

Description	Quantity/Test	Unit	Cat. No.
Test 'N Tube™ NitraVer® X Nitrate Reagent Set	1	50/pkg	26053-45

Required Apparatus

Description	Quantity/Test	Unit	Cat. No.
Funnel, micro, poly	1	each	25843-35
Light Shield	1	each	LZV646
Pipet, TenSette®, 0.1 to 1.0 mL	1	each	19700-01
Pipet Tips, for TenSette Pipet 19700-01	varies	50/pkg	21856-96
Test Tube Rack	1-3	each	18641-00

Recommended Standards and Apparatus

Description	Unit	Cat. No.
Nitrate Nitrogen Standard Solution, 10-mg/L: N	500 mL	307-49
Nitrate Nitrogen Standard Solution, Voluette® Ampule, 500-mg/L N	16/pkg	14260-10
Pipet Tips, for TenSette Pipet 19700-01	1000/pkg	21856-28
Wastewater Influent Inorganics Standard for NH ₃ -N, NO ₃ -N, PO ₄ , COD, SO ₄ , TOC	500 mL	28331-49
Water, deionized	4 L	272-56

Optional Reagents and Apparatus

Description	Cat. No.
Cylinder, mixing, 25 mL	20886-40
Sodium Hydroxide, 5.0 N	2450-26
Sulfuric Acid ACS, Concentrated	979-49
Urea	11237-26



FOR TECHNICAL ASSISTANCE, PRICE INFORMATION AND ORDERING:
In the U.S.A. – Call toll-free 800-227-4224
Outside the U.S.A. – Contact the HACH office or distributor serving you.
On the Worldwide Web – www.hach.com; E-mail – techhelp@hach.com

HACH COMPANY
WORLD HEADQUARTERS
Telephone: (970) 669-3050
FAX: (970) 669-2932

Method 10206

Dimethylphenol Method

TNTplus 836

HR (5–35 mg/L NO₃⁻-N or 22–155 mg/L NO₃)

Scope and Application: For wastewater, drinking water, surface water, and process water



Test Preparation

Before starting the test:

Important Note: Install the light shield in Cell Compartment #2 before performing this test.

Please read Safety Advice and Expiration Date on package.

If the test is not performed at the recommended temperature an incorrect result may be obtained. Analyze samples as soon as possible.

Recommended sample pH is 3–10.

Recommended sample and reagent temperature is 20–23 °C (68–73.4 °F).

Recommended reagent storage is 15–25 °C (59–77 °F).

TNTplus methods are activated from the Main Menu when the sample vial is inserted into the sample cell holder.

Collect the following items:

Quantity

Light Shield	1
Nitrate HR TNT 836 Reagent Set	1
Pipettor for 0.2 mL Sample	1
Pipettor Tip	2

Note: Reorder information for consumables and replacement items is on page 4.

TNTplus

Method 10206

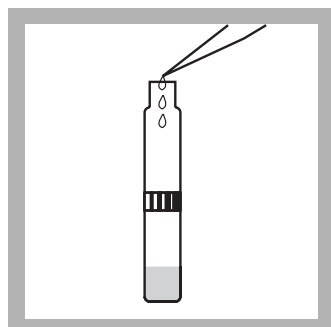

1. Pipet 0.2 mL (200 µL) of sample into the reagent vial.

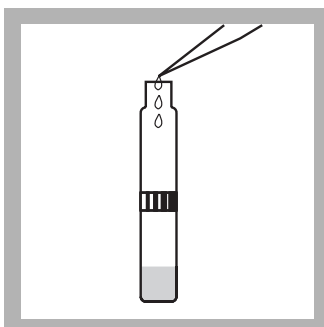

2. Pipet 1.0 mL (1000 µL) of Solution A into the vial.

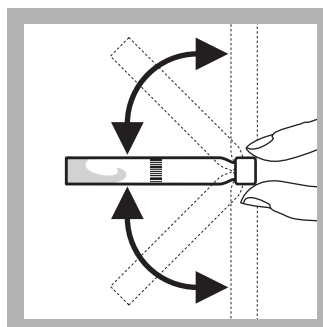

3. Cap and invert the reaction tube 2–3 times until no more streaks can be seen in the vial solution.



4. Wait 15 minutes.
Install the Light Shield in Cell Compartment #2.

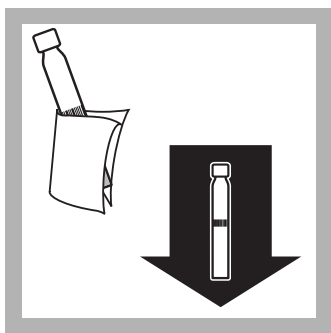

5. After the timer expires wipe the vial and insert it into the cell holder. The instrument reads the barcode, then selects and performs the correct test. No Zero is required.

Results are in mg/L
NO₃-N.

Reagent Blanks

A reagent blank can be measured, and the value subtracted from the results of each test performed using the same reagent lot number. Use deionized water in place of sample and run the procedure as described.

To subtract the value of the blank from a series of measurements, measure the blank per step 5. Press **OPTIONS>MORE>REAGENT BLANK**. Press **ON**. The measured value of the blank should be displayed in the highlighted box. Press **OK** to accept this value. The reagent blank value will now be subtracted from all results until the function is turned off, or a different method is selected. Alternately, the blank can be recorded and entered at any later time by pressing the highlighted box and using the keypad to enter the value.

Sample Blanks

Colored or turbid samples can cause high results. To compensate for color or turbidity the procedure is repeated and the color forming reagent that is present in Solution A is not added.

To determine the sample blank run the procedure as given, but substitute 1.0 mL of deionized water in place of the 1.0 mL of Solution A in step 2. Use the original cap to cap the sample vial. The value obtained in step 5 is then subtracted from the value obtained on the original sample to give the corrected sample concentration.

Alternatively, samples that contain only turbidity may be first filtered through a membrane filter and then analyzed.

Samples without color or turbidity do not require sample blanks.

Interferences

The items listed in [Table 1](#) have been individually checked up to the given concentrations and do not cause interference. Cumulative effects or influence of other ions has not been determined. High loads of oxidizable organic substances (COD) cause the reagent to change color and to give high-bias results. The test can thus only be used for wastewater analyses if the COD is less than 500 mg/L. Measurement results can be verified using sample dilutions or standard additions.

Nitrite concentrations of more than 2.0 mg/L interfere (high-bias results). Add 50 mg of sulfamic acid (amidosulfonic acid) to 5.0 mL of sample, dissolve and wait for 10 minutes. Analyze the prepared sample as described in the procedure above.

Table 1 Interfering Substances and Levels

Interfering Substance	Interference Level
K ⁺	2000 mg/L
Na ⁺	1500 mg/L
Cl ⁻	1000 mg/L
COD	500 mg/L
Ca ²⁺	250 mg/L
Ag ⁺	100 mg/L
Pb ²⁺ , Zn ²⁺ , Ni ²⁺ , Fe ³⁺ , Cd ²⁺ , Cu ²⁺	50 mg/L
Fe ²⁺	20 mg/L
Co ²⁺	10 mg/L
Cr ⁶⁺	5 mg/L
NO ₂ ⁻	2 mg/L

Sample Collection, Preservation, and Storage

Collect samples in clean plastic or glass bottles. Analyze samples as soon as possible to prevent bacteria degradation of the nitrate. If immediate analysis is not possible, store at 4 °C (39 °F) or lower if the sample is to be analyzed within 24 to 48 hours. Warm to 20–23 °C before running the test. For longer storage periods (up to 14 days), adjust sample pH to 2 or less with Sulfuric Acid, ACS* (about 2 mL per liter). Sample refrigeration is still required.

Before testing the stored sample, warm to 20–23 °C and neutralize with 5.0 N Sodium Hydroxide Standard Solution*. Do not use mercury compounds as preservatives. Correct the test result for volume additions.

Accuracy Check

Standard Solution Method

1. Check the accuracy of method with a 10 mg/L nitrate nitrogen standard. Use 0.2 mL of this 10 mg/L standard in place of the sample in step 2.
2. Alternately, use 0.2 mL of a Wastewater Influent Mixed Parameters Inorganics Standard in place of the sample in step 2. This standard contains 10 mg/L nitrate nitrogen combined with ammonia, phosphate, sulfate and organic material.

* See [Optional Reagents and Apparatus on page 4](#).

Nitrate HR (5–35 mg/L NO₃⁻-N or 22–155 mg/L NO₃)

Summary of Method

Nitrate ions in solutions containing sulfuric and phosphoric acids react with 2,6-dimethylphenol to form 4-nitro-2,6-dimethylphenol. Test results are measured at 345 nm.

Consumables and Replacement Items

Required Reagents

Description	Quantity/Test	Unit	Cat. No.
Nitrate TNTplus, HR TNT 836	1	25/pkg	TNT836

Required Apparatus

Description	Quantity/Test	Unit	Cat. No.
Light Shield	1	each	LZV646
Pipettor, variable volume, 100–1000 µL	1	each	27949-00
Pipettor Tips, for 27949-00 pipettor	1	400/pkg	27950-00

Recommended Standards and Apparatus

Description	Unit	Cat. No.
Nitrate Nitrogen Standard Solution, 10-mg/L NO ₃ -N	500 mL	307-49
Nitrate Nitrogen Standard Solution, 1000 mg/L NO ₃ -N	500 mL	12792-49
Wastewater Influent Inorganics Standard for NH ₃ -N, NO ₃ -N, PO ₄ , COD, SO ₄ , TOC	500 mL	28331-49
Water, deionized	4 L	272-56

Optional Reagents and Apparatus

Description	Cat. No.
Balance, AccuLab VI-Series, 120 g capacity	26947-00
Bottle, sampling, low density poly, w/cap, 500 mL, 12/pkg	20870-79
Filter Holder, glass for vacuum filtration (SUVA)	2340-00
Filter, membrane, 47-mm, 0.45-micron, hydrophilic, polyethersulfone for SUVA	28947-00
Flask, filtering, glass, 1000-mL (SUVA)	546-53
Sodium Hydroxide, 5.0 N, 50 mL	2450-26
Sulfamic Acid, 113 g	2344-14
Sulfuric Acid ACS, concentrated, 500 mL	979-49
Test Tube Rack for 13-mm vials	24979-00
Tubing, rubber, 12-ft	560-19



FOR TECHNICAL ASSISTANCE, PRICE INFORMATION AND ORDERING:
In the U.S.A. – Call toll-free 800-227-4224
Outside the U.S.A. – Contact the HACH office or distributor serving you.
On the Worldwide Web – www.hach.com; E-mail – techhelp@hach.com

HACH COMPANY
WORLD HEADQUARTERS
Telephone: (970) 669-3050
FAX: (970) 669-2932

Method 10206

Dimethylphenol Method

TNTplus 835

LR (0.23 to 13.50 mg/L NO₃⁻-N or 1.00 to 60.00 mg/L NO₃)

Scope and Application: For wastewater, drinking water, surface water, and process water



Test Preparation

Before starting the test:

Important Note: Install the light shield in Cell Compartment #2 before performing this test.

Please read Safety Advice and Expiration Date on package.

If the test is not performed at the recommended temperature an incorrect result may be obtained. Analyze samples as soon as possible.

Recommended sample pH is 3–10.

Recommended sample and reagent temperature is 20–23 °C (68–73.4 °F).

Recommended reagent storage is 15–25 °C (59–77 °F).

TNTplus methods are activated from the Main Menu when the sample vial is inserted into the sample cell holder.

Collect the following items:

Quantity

Light Shield	1
Nitrate LR TNT 835 Reagent Set	1
Pipettor for 0.2 mL Sample	1
Pipettor Tip	2

Note: Reorder information for consumables and replacement items is on page 4.

TNTplus

Method 10206

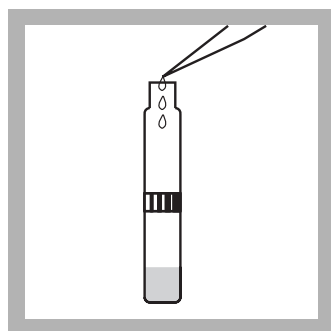

1. Pipet 1.0 mL (1000 µL) of sample into the reagent vial.

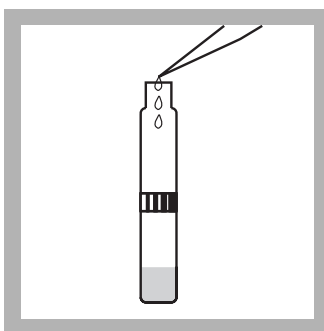

2. Pipet 0.2 mL (200 µL) of Solution A into the vial.

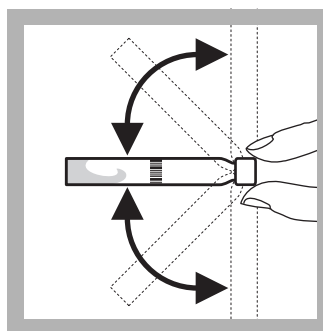

3. Cap and invert the reaction tube 2–3 times until no more streaks can be seen in the reaction tube solution.



4. Wait 15 minutes.
Install the Light Shield in Cell Compartment #2.

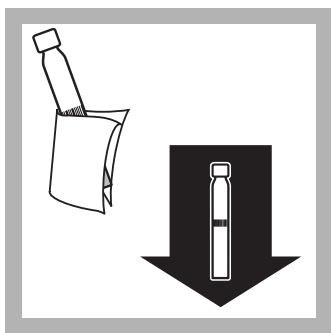

5. After the timer expires wipe the vial and insert the prepared vial into the cell holder. The instrument reads the barcode, then selects and performs the correct test. No Zero is required.

Results are in mg/L NO₃-N

Reagent Blanks

A reagent blank can be measured, and the value subtracted from the results of each test performed using the same reagent lot number. Use deionized water in place of sample and run the procedure as described.

To subtract the value of the blank from a series of measurements, measure the blank per step 5. Press **OPTIONS>MORE>REAGENT BLANK**. Press **ON**. The measured value of the blank should be displayed in the highlighted box. Press **OK** to accept this value. The reagent blank value will now be subtracted from all results until the function is turned off, or a different method is selected. Alternately, the blank can be recorded and entered at any later time by pressing the highlighted box and using the keypad to enter the value.

Sample Blanks

Colored or turbid samples can cause high results. To compensate for color or turbidity the procedure is repeated and the color forming reagent that is present in Solution A is not added.

To determine the sample blank run the procedure as given, but substitute 0.2 mL of deionized water in place of the 0.2 mL of Solution A in step 2. Use the original cap to cap the sample vial. The value obtained in step 5 is then subtracted from the value obtained on the original sample to give the corrected sample concentration.

Alternatively, samples that contain only turbidity may be first filtered through a membrane filter and then analyzed.

Samples without color or turbidity do not require sample blanks.

Interferences

The items listed in [Table 1](#) have been individually checked up to the given concentrations and do not cause interference. The cumulative effects and influence of other ions has not been determined. High loads of oxidizable organic substances (COD) cause the reagent to change color and to give high-bias results. The test can thus only be used for wastewater analyses if the COD is less than 500 mg/L. Measurement results can be verified using sample dilutions or standard additions.

Nitrite concentrations of more than 2.0 mg/L interfere (high-bias results). Add 50 mg of sulfamic acid (amidosulfonic acid) to 5.0 mL of sample, dissolve and wait for 10 minutes. Analyze the prepared sample as described in the procedure above.

Table 1 Interfering Substances and Levels

Interfering Substance	Interference Level
K ⁺ , Na ⁺ , Cl ⁻	500 mg/L
Ag ⁺	100 mg/L
Pb ²⁺ , Zn ²⁺ , Ni ²⁺ , Fe ³⁺ , Cd ²⁺ , Sn ²⁺ , Ca ²⁺ , Cu ²⁺	50 mg/L
Fe ²⁺ , Co ²⁺	10 mg/L
Cr ⁶⁺	5 mg/L
NO ₂ ⁻	2 mg/L

Sample Collection, Preservation, and Storage

Collect samples in clean plastic or glass bottles. Analyze samples as soon as possible to prevent bacteria degradation of the nitrate. If immediate analysis is not possible, store at 4 °C (39 °F) or lower if the sample is to be analyzed within 24 to 48 hours. Warm to 20–23 °C before running the test. For longer storage periods (up to 14 days), adjust sample pH to 2 or less with Sulfuric Acid, ACS* (about 2 mL per liter). Sample refrigeration is still required.

Before testing the stored sample, warm to 20–23 °C and neutralize with 5.0 N Sodium Hydroxide Standard Solution*. Do not use mercury compounds as preservatives. Correct the test result for volume additions.

Accuracy Check

Standard Solution Method

1. Check the accuracy of method with a 10 mg/L nitrate nitrogen standard. Use 1.0 mL of this 10 mg/L standard in place of the sample in step 1.
2. Alternately, use 1.0 mL of a Wastewater Influent Mixed Parameters Inorganics Standard in place of the sample in step 1. This standard contains 10 mg/L nitrate nitrogen combined with ammonia, phosphate, sulfate, and organic material.

Summary of Method

Nitrate ions in solutions containing sulfuric and phosphoric acids react with 2,6-dimethylphenol to form 4-nitro-2,6-dimethylphenol. Test results are measured at 345 nm.

* See [Optional Reagents and Apparatus on page 4](#).

Consumables and Replacement Items

Required Reagents

Description	Quantity/Test	Unit	Cat. No.
Nitrate TNTplus, LR TNT 835	1	25/pkg	TNT835

Required Apparatus

Description	Quantity/Test	Unit	Cat. No.
Light Shield	1	each	LZV646
Pipettor, variable volume, 100–1000 µL	1	each	27949-00
Pipettor Tips, for 27949-00 pipettor	1	400/pkg	27950-00

Recommended Standards and Apparatus

Description	Unit	Cat. No.
Nitrate Nitrogen Standard Solution, 10-mg/L	500 mL	307-49
Nitrate Nitrogen Standard Solution, 1000 mg/L	500 mL	12792-49
Wastewater Influent Inorganics Standard for NH ₃ -N, NO ₃ -N, PO ₄ , COD, SO ₄ , TOC	500 mL	28331-49
Water, deionized	4 L	272-56

Optional Reagents and Apparatus

Description	Cat. No.
Balance, AccuLab VI-Series, 120 g capacity	26947-00
Bottle, sampling, low density poly, w/cap, 500 mL, 12/pkg	20870-79
Filter Holder, glass, for vacuum filtration (SUVA)	2340-00
Filter, membrane, 47-00; 0.45-micron, hydrophilic, polyethersulfone	28947-00
Flask, filtering, glass, 1000-mL (SUVA)	546-53
Sodium Hydroxide, 5.0 N, 50 mL	2450-26
Sulfamic Acid, 113 g	2344-14
Sulfuric Acid ACS, concentrated, 500 mL	979-49
Test Tube Rack for 13-mm vials	24979-00
Tubing, rubber, 12-ft	560-19



FOR TECHNICAL ASSISTANCE, PRICE INFORMATION AND ORDERING:
 In the U.S.A. – Call toll-free 800-227-4224
 Outside the U.S.A. – Contact the HACH office or distributor serving you.
 On the Worldwide Web – www.hach.com; E-mail – techhelp@hach.com

HACH COMPANY
 WORLD HEADQUARTERS
 Telephone: (970) 669-3050
 FAX: (970) 669-2932

Method 8171

Powder Pillows or AccuVac® Ampuls

Cadmium Reduction Method

MR (0.1 to 10.0 mg/L NO₃⁻-N)

Scope and Application: For water, wastewater, and seawater



Test Preparation

Before starting the test:

For more accurate results, determine a reagent blank value for each new lot of reagent. Follow the procedure using deionized water instead of the sample.

A deposit of unoxidized metal will remain after the NitraVer® 5 dissolves. The deposit will not affect results.

This method is technique-sensitive. Shaking time and technique influence color development. For most accurate results, make successive tests on a 10.0-mg/L Nitrate Nitrogen Standard solution. Adjust shaking times to obtain the correct result.

Rinse the sample cell immediately after use to remove all cadmium particles. Retain the used sample for proper hazardous waste disposal for cadmium.

Prepared samples will contain cadmium and must be disposed of according to Federal, State, and local hazardous waste regulations. Refer to the current MSDS for safe handling and disposal instructions.

Collect the following items:

Quantity

Collect the following items:	Quantity
Powder Pillow Test:	
NitraVer® 5 Nitrate Reagent Powder Pillow	1
Sample Cells, 1-inch square, 10-mL	2
Stopper, Neoprene #2, solid	2
AccuVac Test:	
Collect at least 40 mL of sample in a 50-mL beaker	40 mL
NitraVer® 5 Nitrate Reagent AccuVac® Ampul	1
Beaker, 50-mL (AccuVac test)	1
Sample Cell, 10-mL	1

Note: Reorder information for consumables and replacement items is on page 6.

Powder Pillows

Method 8171



1. Press **STORED PROGRAMS**.



2. Select the test.

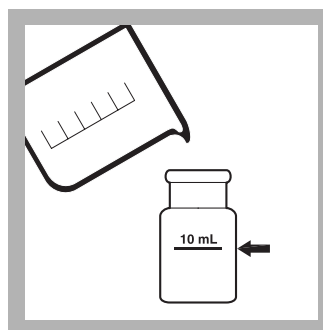

3. Fill a square sample cell with 10 mL of sample.

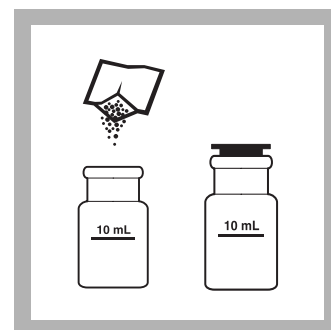

4. **Prepared Sample:** Add the contents of one NitraVer 5 Nitrate Reagent Powder Pillow. Insert a stopper into the cell.

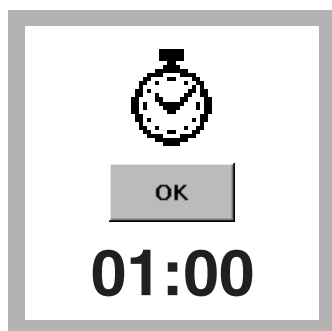

5. Press **TIMER>OK.**
A one-minute reaction period will begin.
Shake the cell vigorously until the timer expires.

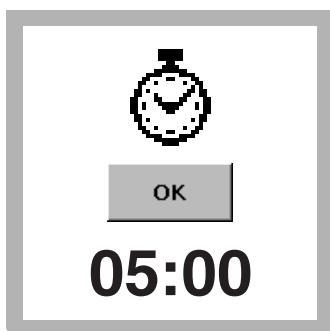

6. When the timer expires, press **TIMER>OK.**
A five-minute reaction period will begin.
An amber color will develop if nitrate is present.

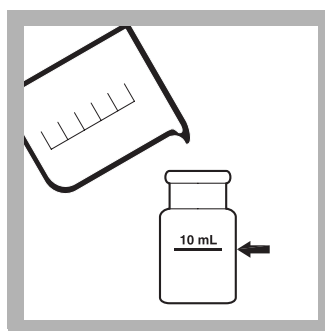

7. Blank Preparation:
When the timer expires, fill a second square sample cell with 10 mL of sample.

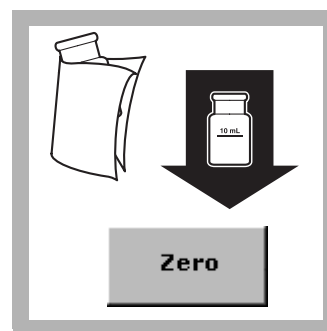

8. Insert the blank into the cell holder with the fill line facing right. Press **ZERO.**
The display will show:
0.0 mg/L NO₃⁻-N



9. Within two minutes after the timer expires, insert the prepared sample into the cell holder with the fill line facing right.

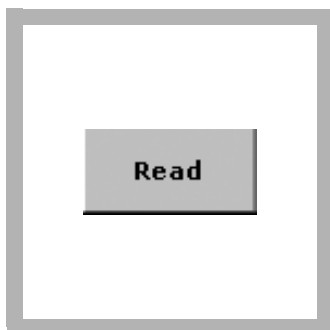

10. Press **READ.**
Results are in mg/L NO₃⁻-N.

AccuVac® Ampul

Method 8171

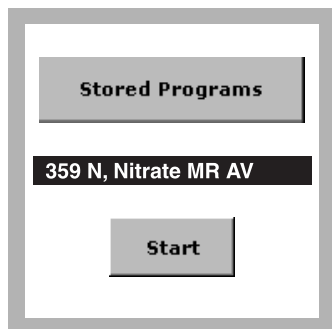

1. Select the test.

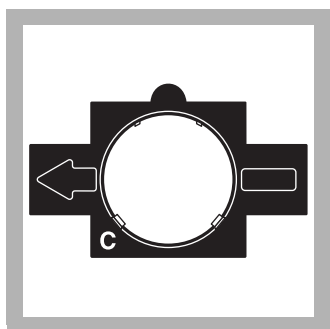

2. Insert Adapter C.

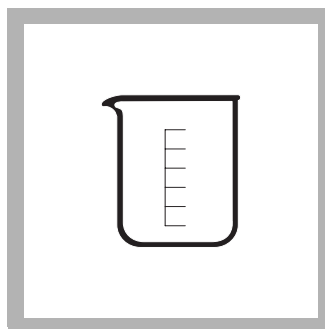

3. Prepared Sample:
Collect at least 40 mL of sample in a 50-mL beaker.

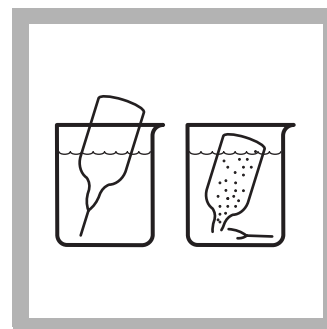

4. Fill a NitraVer 5 Nitrate AccuVac® Ampul with sample. Keep the tip immersed while the Ampul fills completely. Place a stopper over the Ampul tip.

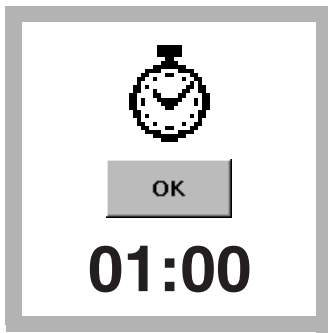

5. Press **TIMER>OK.**
A one-minute reaction period will begin.

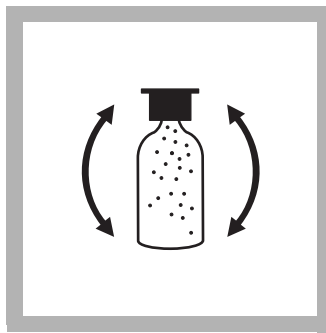

6. Invert the Ampul 48–52 times as the timer counts down.

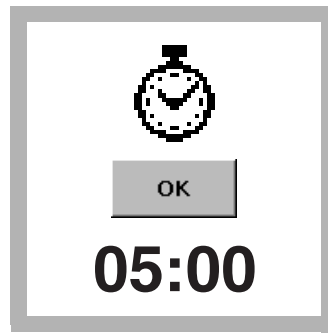

7. When the timer expires, press **TIMER>OK.**
A five-minute reaction period will begin. An amber color will develop if nitrate is present.



8. Blank Preparation:
When the timer expires, fill a round sample cell with 10 mL of sample.

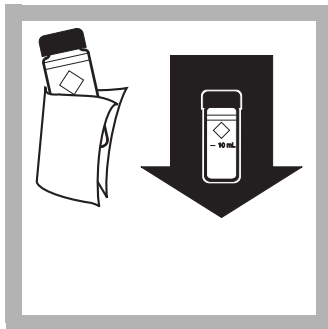

9. Wipe the blank and insert it into the cell holder.

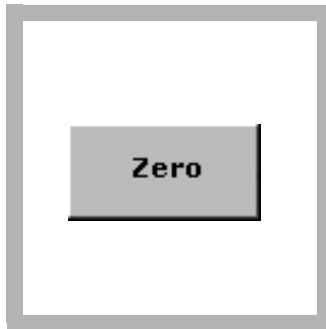

10. Press **ZERO.**
The display will show:
0.0 mg/L NO₃⁻-N



11. Within two minutes after the timer expires, wipe the Ampul and insert it into the cell holder.

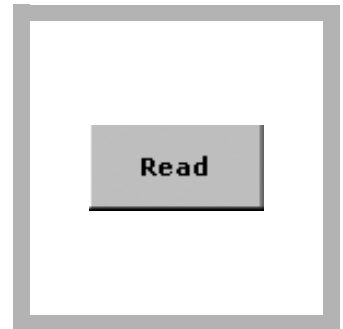

12. Press **READ.**
Results are in mg/L NO₃⁻-N.

Interferences

Table 1 Interfering Substances and Levels

Interfering Substance	Interference Levels and Treatments
Chloride	Chloride concentrations above 100 mg/L will cause low results. The test may be used at high chloride concentrations (seawater) but a calibration must be done using standards spiked to the same chloride concentration.
Ferric iron	Interferes at all levels
Nitrite	Interferes at all levels Compensate for nitrite interference as follows: <ol style="list-style-type: none"> 1. Add 30-g/L Bromine Water¹ dropwise to the sample before NitraVer 5 Reagent addition until a yellow color remains. 2. Add one drop of 30-g/L Phenol Solution¹ to destroy the color. 3. Proceed with the test. Report the results as total nitrate and nitrite.
pH	Highly buffered samples or extreme sample pH may exceed the buffering capacity of the reagents and require sample pretreatment.
Strong oxidizing and reducing substances	Interfere at all levels

¹ See [Optional Reagents and Apparatus on page 6](#).

Sample Collection, Storage, and Preservation

Most reliable results are obtained when samples are analyzed as soon as possible after collection. If prompt analysis is impossible, store samples in clean plastic or glass bottles for up to 24 hours at 4 °C. To preserve samples for longer periods, add 2 mL of Concentrated Sulfuric Acid (H₂SO₄)* per liter and store at 4 °C.

Before analysis, warm the sample to room temperature and adjust the pH to 7 with 5.0 N Sodium Hydroxide Standard Solution*. Do not use mercury compounds as preservatives. Correct the test result for volume additions by dividing the total volume (acid + base + sample) by the original sample volume and multiplying the test result by this factor.

Accuracy Check

Standard Additions Method (Sample Spike)

1. After reading test results, leave the sample cell (unspiked sample) in the instrument. Verify the chemical form.
2. Press **OPTIONS>MORE**. Press **STANDARD ADDITIONS**. A summary of the standard additions procedure will appear.
3. Press **OK** to accept the default values for standard concentration, sample volume, and spike volumes. Press **EDIT** to change these values. After values are accepted, the unspiked sample reading will appear in the top row. See the user manual for more information.
4. Open a fresh bottle of Nitrate Nitrogen Standard, 100-mg/L NO₃⁻-N.

* See [Optional Reagents and Apparatus on page 6](#).

5. Prepare three sample spikes. Fill three sample cells with 10 mL of sample. Use the TenSette® Pipet to add 0.1 mL, 0.2 mL, and 0.3 mL of standard, respectively, to each sample and mix thoroughly.
6. Analyze each sample spike as described in the procedure above, starting with the 0.1 mL sample spike. Accept each standard additions reading by pressing **READ**. Each addition should reflect approximately 100% recovery.

Note: For AccuVac® Ampuls, fill three Mixing Cylinders with 50 mL of sample and spike with 0.1 mL, 0.2 mL, and 0.3 mL of 500 mg/L Nitrate Nitrogen Ampule Standard Solution. Transfer 40 mL from each of the three mixing cylinders to three 50-mL beakers*. Analyze each standard addition sample as described in the procedure above. Accept each standard additions reading by pressing **READ**. Each addition should reflect approximately 100% recovery.

7. After completing the sequence, press **GRAPH** to view the best-fit line through the standard additions data points, accounting for matrix interferences. Press **IDEAL LINE** to view relationships between the sample spikes and the "Ideal Line" of 100% recovery.

Standard Solution Method

1. To test accuracy, use a 5.0-mg/L Nitrate Nitrogen Standard Solution instead of the sample and perform the procedure as described above.
2. Prepare a 5.0 mg/L Nitrate Nitrogen Standard by pipetting 5.0 mL of a 100 mg/L Nitrate Nitrogen Standard into a 100 mL volumetric flask. Dilute to volume with deionized water and mix well.
3. To adjust the calibration curve using the reading obtained with the standard solution, press **OPTIONS>MORE** on the current program menu. Press **STANDARD ADJUST**.
4. Press **ON**. Press **ADJUST** to accept the displayed concentration. If an alternate concentration is used, press the number in the box to enter the actual concentration, then press **OK**. Press **ADJUST**.

Summary of Method

Cadmium metal reduces nitrates in the sample to nitrite. The nitrite ion reacts in an acidic medium with sulfanilic acid to form an intermediate diazonium salt. The salt couples with gentisic acid to form an amber colored solution. Test results are measured at 400 nm.

* See [Optional Reagents and Apparatus on page 6](#).

Consumables and Replacement Items

Required Reagents

Description	Quantity/Test	Unit	Cat. No.
NitraVer® 5 Nitrate Reagent Powder Pillows (for 10 mL sample)	1	100/pkg	21061-69
OR			
NitraVer® 5 Nitrate Reagent AccuVac® Ampul	1	25/pkg	25110-25

Required Apparatus (Powder Pillows)

Description	Quantity/Test	Unit	Cat. No.
Sample Cells, 1-inch square, 10 mL, matched pair	2	2/pkg	24954-02
Stopper, Neoprene, solid, size no. 2	2	12/pkg	14808-02

Required Apparatus (AccuVac)

Description	Quantity/Test	Unit	Cat. No.
Adapter, 1-inch round, for AccuVac Ampuls	1	each	LZV584
Beaker, 50-mL	1	each	500-41H
Sample Cell, 10-mL, with cap	1	each	21228-00

Recommended Standards and Apparatus

Description	Unit	Cat. No.
Flask, volumetric, 100-mL	each	14574-42
Mixed Parameter Drinking Water Standard, for F, NO ₃ -N, PO ₄ , SO ₄	500 mL	28330-49
Nitrate Nitrogen Standard Solution, 100-mg/L NO ₃ ⁻ -N	500 mL	1947-49
Nitrate Nitrogen Standard Solution, 500 mg/L NO ₃ -N, 10-mL ampules	16/pkg	14260-10
Pipet, TenSette, 0.1–1.0 mL	each	19700-01
Pipet Tips, for TenSette Pipet 19700-01	50/pkg	21856-96
Pipet Tips, for TenSette Pipet 19700-01	1000/pkg	21856-28
Pipet, volumetric, 5.00 mL	each	14515-37
Pipet Filler, safety bulb	each	14651-00
Water, deionized	4 L	272-56

Optional Reagents and Apparatus

Description	Cat. No.
Bromine Water, 30-mg/L	2211-20
Cylinder, mixing	20886-41
Phenol Solution, 30-g/L	2112-20
5.0 N Sodium Hydroxide Standard Solution	2450-53
Sulfuric Acid, concentrated	979-49



FOR TECHNICAL ASSISTANCE, PRICE INFORMATION AND ORDERING:
 In the U.S.A. – Call toll-free 800-227-4224
 Outside the U.S.A. – Contact the HACH office or distributor serving you.
 On the Worldwide Web – www.hach.com; E-mail – techhelp@hach.com

HACH COMPANY
 WORLD HEADQUARTERS
 Telephone: (970) 669-3050
 FAX: (970) 669-2932

Method 10019

Diazotization Method

Test 'N Tube™ Vials

LR (0.003 to 0.500 mg/L NO₂⁻-N)

Scope and Application: For water, wastewater, and seawater



Test Preparation

Before starting the test:

Important Note: Install the light shield in Cell Compartment #2 before performing this test.

For more accurate results, determine a reagent blank value for each new lot of reagent. Follow the procedure using deionized water in place of the sample. Subtract the reagent blank value from the final results or perform a reagent blank adjust.

Collect the following items:

Quantity

Light Shield	1
Test 'N Tube™ NitriVer® 3 Nitrite Reagent Set	1
Pipet, TenSette®, 1.0 to 10.0 mL, plus tips	1

Note: Reorder information for consumables and replacement items is on page 3.

Test 'N Tube

Method 10019

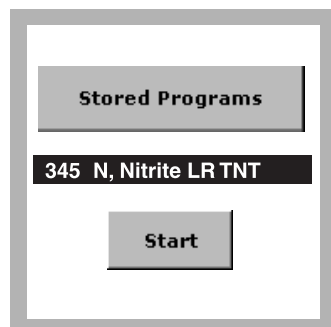

1. Select the test.

Install the Light Shield in Cell Compartment #2.

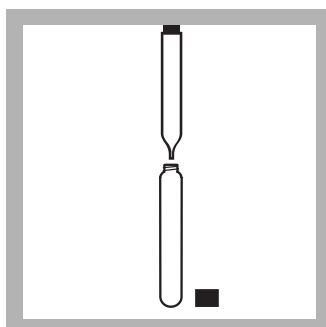

2. Fill a Test 'N Tube NitriVer® 3 Nitrite vial with 5 mL of sample.

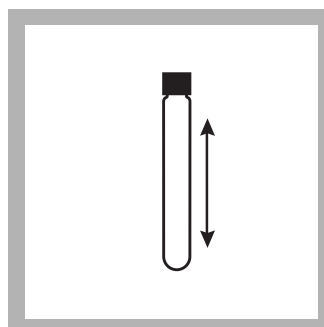

3. **Prepared Sample:** Cap and shake to dissolve the powder.

A pink color will develop if nitrite-nitrogen is present.



4. Press **TIMER>OK**.

A 20-minute reaction period will begin.

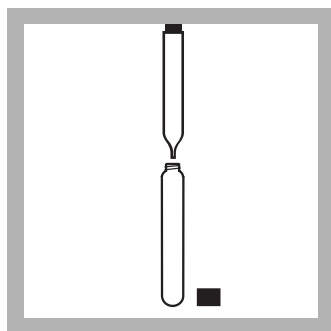

5. Blank Preparation:
When the timer expires, fill an empty Test 'N Tube™ vial with 5 mL of sample.



6. Wipe the blank and insert it into the 16-mm round cell holder.

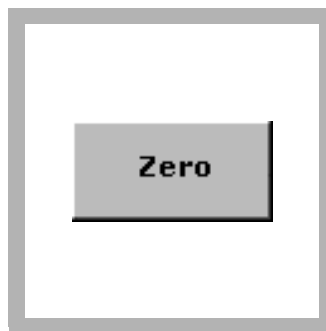

7. Press ZERO.
The display will show:
0.000 mg/L NO₂⁻-N

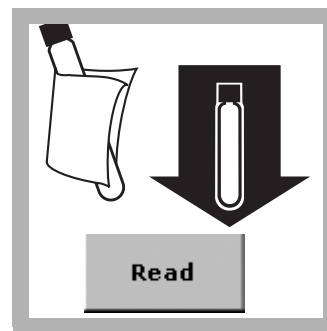

8. Insert the prepared sample cell into the 16-mm round cell holder.
Press **READ**. Results are in mg/L NO₂⁻-N.

Interferences

Table 1 Interfering Substances and Levels

Interfering Substance	Interference Levels and Treatments
Antimonous ions	Interfere by causing precipitation
Auric ions	Interfere by causing precipitation
Bismuth ions	Interfere by causing precipitation
Chloroplatinate ions	Interfere by causing precipitation
Cupric ions	Cause low results
Ferric ions	Interfere by causing precipitation
Ferrous ions	Cause low results
Lead ions	Interfere by causing precipitation
Mercurous ions	Interfere by causing precipitation
Metavanadate ions	Interfere by causing precipitation
Nitrate	Very high levels of nitrate (>100 mg/L nitrate as N) appear to undergo a slight amount of reduction to nitrite, either spontaneously or during the course of the test. A small amount of nitrite will be found at these levels.
Silver ions	Interfere by causing precipitation
Strong oxidizing and reducing substances	Interfere at all levels

Sample Collection, Storage, and Preservation

Collect samples in clean plastic or glass bottles. Store at 4 °C (30 °F) or lower if the sample is to be analyzed within 24 to 48 hours. Warm to room temperature before running the test.

Accuracy Check

Standard Solution Method

Preparing nitrite standards is difficult. Use the standard preparation instructions in *Standard Methods for the Examination of Water and Wastewater*, Method 4500-NO₂ B. Prepare a 0.300-mg/L standard. Perform the nitrite test on the standard solution.

Summary of Method

Nitrite in the sample reacts with sulfanilic acid to form an intermediate diazonium salt. This couples with chromotropic acid to produce a pink colored complex directly proportional to the amount of nitrite present. Test results are measured at 507 nm.

Consumables and Replacement Items

Required Reagents

Description	Quantity/Test	Unit	Cat. No.
Test 'N Tube™ NitriVer® 3 Nitrite Reagent Set	1	50/pkg	26083-45

Required Apparatus

Description	Quantity/Test	Unit	Cat. No.
Light Shield	1	each	LZV646
Pipet, TenSette®, 1.0 to 10.0 mL	1	each	19700-10
Pipet Tips, for TenSette Pipet 19700-10	varies	50/pkg	21997-96

Recommended Standards and Apparatus

Description	Unit	Cat. No.
Handbook, Standard Methods for the Examination of Water and Wastewater	each	22708-00
Pipet Tips, for TenSette Pipet 19700-10	250/pkg	21997-25
Sodium Nitrite, ACS	454 g	2452-01
Water, deionized	4 L	272-56



FOR TECHNICAL ASSISTANCE, PRICE INFORMATION AND ORDERING:

In the U.S.A. – Call toll-free 800-227-4224
Outside the U.S.A. – Contact the HACH office or distributor serving you.
On the Worldwide Web – www.hach.com; E-mail – techhelp@hach.com

HACH COMPANY
WORLD HEADQUARTERS
Telephone: (970) 669-3050
FAX: (970) 669-2932

★Method 8507

Diazotization Method

Powder Pillows or AccuVac® Ampuls

LR (0.002 to 0.300 mg/L NO₂⁻-N)

Scope and Application: For water, wastewater, and seawater; USEPA approved for wastewater analysis¹

¹ Federal Register, 44(85), 25505 (May 1, 1979)



Test Preparation

Before starting the test:

For more accurate results, determine a reagent blank value for each new lot of reagent. Follow the procedure using deionized water instead of the sample.

Collect the following items:

Quantity

Collect the following items:	Quantity
Powder Pillow Test:	
NitriVer® 3 Nitrite Reagent Powder Pillows	1
Sample Cells, 1-inch square, 10-mL	2
AccuVac Test:	
NitriVer® 3 Nitrite Reagent AccuVac® Ampul.	1
Beaker, 50-mL	1
Sample Cell, 10-mL	1

Note: Reorder information for consumables and replacement items is on page 4.

Powder Pillows

Method 8507



1. Press **STORED PROGRAMS**.



2. Select the test.

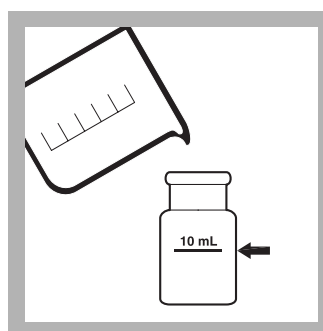

3. Fill a square sample cell with 10 mL of sample.

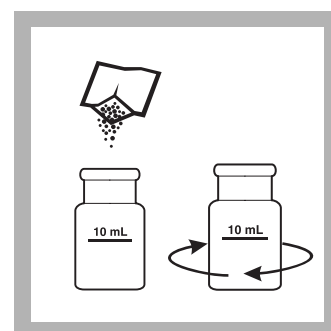

4. **Prepared Sample:** Add the contents of one NitriVer 3 Nitrite Reagent Powder Pillow. Swirl to dissolve.

A pink color will develop if nitrite is present.



5. Press **TIMER>OK**.
A 20-minute reaction period will begin.

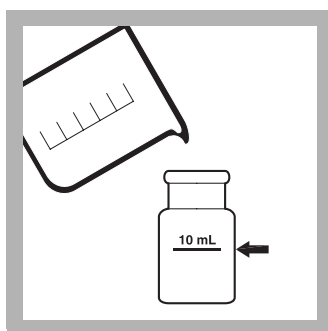

6. **Blank Preparation:**
When the timer expires, fill a second square sample cell with 10 mL of sample.

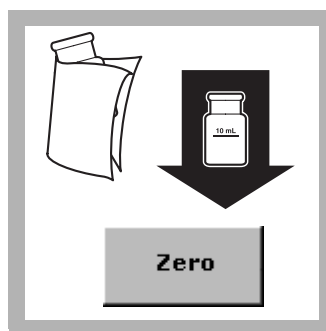

7. Wipe the blank and insert it into the cell holder with the fill line facing right. Press **ZERO**.
The display will show:
0.000 mg/L NO₂⁻-N

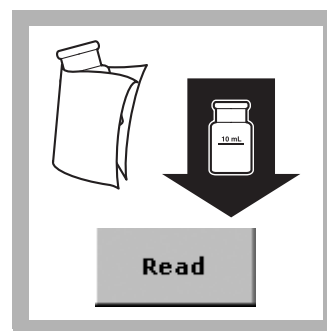

8. Wipe the prepared sample and insert it into the cell holder with the fill line facing right. Press **READ**. Results are in mg/L NO₂⁻-N.

AccuVac[®] Ampul

Method 8507

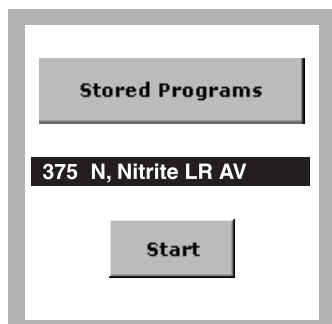

1. Select the test.

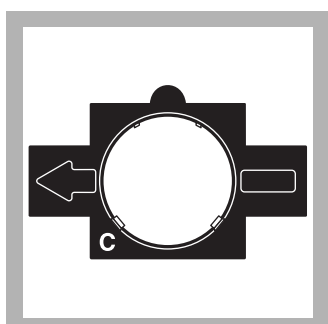

2. Insert Adapter C.

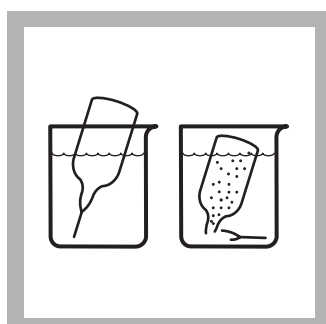

3. **Prepared Sample:**
Collect at least 40 mL of sample into a 50-mL beaker.

Fill a NitriVer 3 Nitrite AccuVac[®] Ampul with sample. Keep the tip immersed while the Ampul fills.

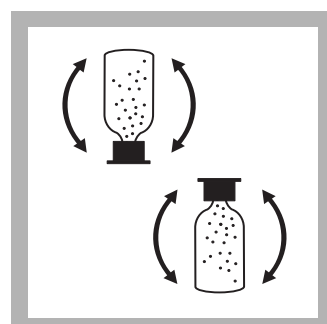

4. Invert the Ampul several times to mix. A pink color will develop if nitrite is present.

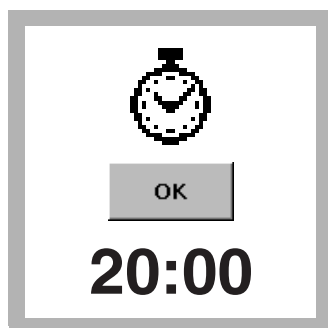

5. Press **TIMER**. Press **OK**. A 20-minute reaction period will begin.

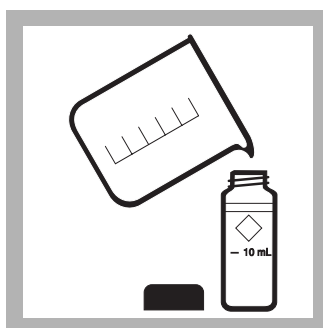

6. **Blank Preparation:**
When the timer expires, fill a sample cell with at least 10 mL of sample.

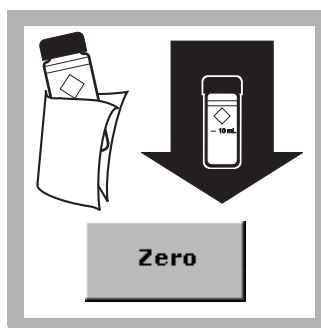

7. Wipe the blank and insert it into the cell holder. Press **ZERO**.
The display will show:
0.000 mg/L NO₂⁻-N



8. Wipe the AccuVac Ampul and insert it into the cell holder.
Press **READ**. Results are in mg/L NO₂⁻-N.

Interferences

Table 1 Interfering Substances and Levels

Interfering Substance	Interference Levels and Treatments
Antimonous ions	Interfere by causing precipitation
Auric ions	Interfere by causing precipitation
Bismuth ions	Interfere by causing precipitation
Chloroplatinate ions	Interfere by causing precipitation
Cupric ions	Cause low results
Ferric ions	Interfere by causing precipitation
Ferrous ions	Cause low results
Lead ions	Interfere by causing precipitation
Mercurous ions	Interfere by causing precipitation
Metavanadate ions	Interfere by causing precipitation
Nitrate	Very high levels of nitrate (>100 mg/L nitrate as N) appear to undergo a slight amount of reduction to nitrite, either spontaneously or during the course of the test. A small amount of nitrite will be found at these levels.
Silver ions	Interfere by causing precipitation
Strong oxidizing and reducing substances	Interferes at all levels

Sample Collection, Storage, and Preservation

Collect samples in clean plastic or glass bottles. Store at 4 °C (30 °F) or lower if the sample is to be analyzed within 24 to 48 hours. Warm to room temperature before running the test. Do not use acid preservatives.

Accuracy Check

Standard Solution Method

Preparing nitrite standards is difficult. Use the standard preparation instructions in *Standard Methods for the Examination of Water and Wastewater*, Method 4500—NO₂-B. Prepare a 0.150-mg/L standard.

Summary of Method

Nitrite in the sample reacts with sulfanilic acid to form an intermediate diazonium salt. This couples with chromotropic acid to produce a pink colored complex directly proportional to the amount of nitrite present. Test results are measured at 507 nm.

Consumables and Replacement Items

Required Reagents

Description	Quantity/Test	Unit	Cat. No.
NitriVer® 3 Nitrite Reagent Powder Pillows	1	100/pkg	21071-69
OR			
NitriVer® 3 Nitrite Reagent AccuVac® Ampul	1	25/pkg	25120-25

Required Apparatus (Powder Pillows)

Description	Quantity/Test	Unit	Cat. No.
Sample Cells, 1-inch square, 10 mL, matched pair	2	2/pkg	24954-02

Required Apparatus (AccuVac)

Description	Quantity/Test	Unit	Cat. No.
Adapter, 1-inch round, AccuVac Ampuls	1	each	LZV584
Beaker, 50-mL	1	each	500-41H
Sample Cell, 10-mL, with cap	1	each	21228-00

Recommended Standards and Apparatus

Description	Unit	Cat. No.
Balance, analytical, SA80, 115 VAC	each	28014-01
Handbook, Standard Methods for the Examination of Water and Wastewater	—	—
Sodium Nitrite, ACS	454 g	2452-01
Water, deionized	4 L	242-56



FOR TECHNICAL ASSISTANCE, PRICE INFORMATION AND ORDERING:
In the U.S.A. – Call toll-free 800-227-4224
Outside the U.S.A. – Contact the HACH office or distributor serving you.
On the Worldwide Web – www.hach.com; E-mail – techhelp@hach.com

HACH COMPANY
WORLD HEADQUARTERS
Telephone: (970) 669-3050
FAX: (970) 669-2932

Method 8153

Powder Pillows

Ferrous Sulfate Method¹

HR (2 to 250 mg/L NO₂⁻)

Scope and Application: For cooling tower waters

¹ Adapted from McAlpine, R. and Soule, B., *Qualitative Chemical Analysis*, New York, 476, 575 (1933)



Test Preparation

Before starting the test:

For more accurate results, determine a reagent blank value for each new lot of reagent. Follow the procedure using deionized water instead of the sample. Subtract the reagent blank value from the final results or perform a reagent blank adjust.

After adding the reagent, a greenish-brown color will develop if nitrite is present.

Collect the following items:

Quantity

NitriVer® 2 Nitrite Reagent Powder Pillows	1
Deionized water	varies
Stopper, Neoprene, solid # 1	2
Sample Cells, 1-inch square, 10-mL	2

Note: Reorder information for consumables and replacement items is on page 3.

Powder Pillows

Method 8153



1. Press **STORED PROGRAMS**.

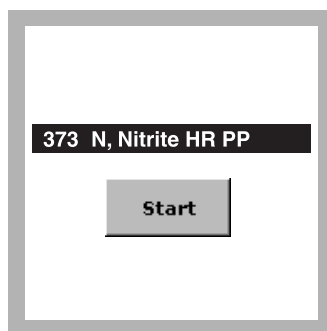

2. Select the test.

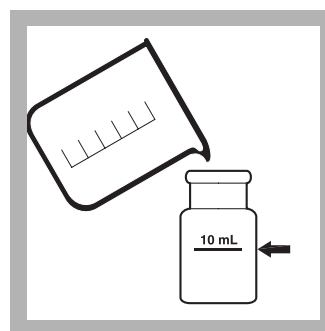

3. Fill a square sample cell with 10 mL of sample.

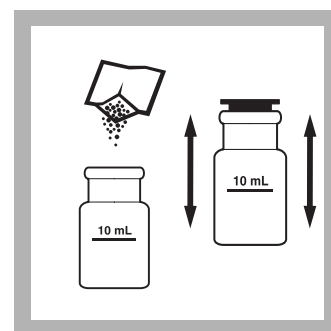

4. **Prepared Sample:** Add the contents of one NitriVer® 2 Nitrite Reagent Powder Pillow. Stopper and shake to dissolve.

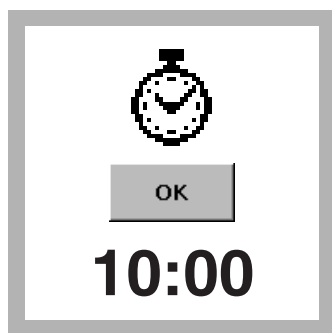

5. Press TIMER>OK.

A ten-minute reaction period will begin. To prevent low results, leave the sample on a flat surface and **do not disturb it during the reaction period.**

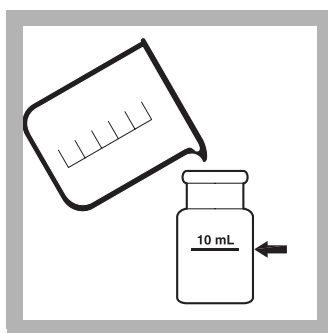

6. Blank Preparation:
Fill a second square sample cell with 10 mL of sample.



7. Wipe the blank and insert it into the cell holder will the fill line facing right.

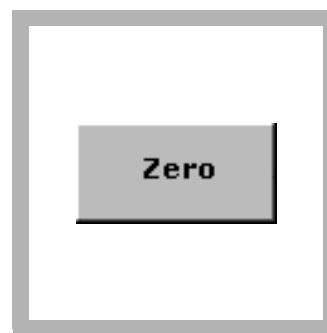

8. Press ZERO.

The display will show: 0 mg/L NO₂⁻

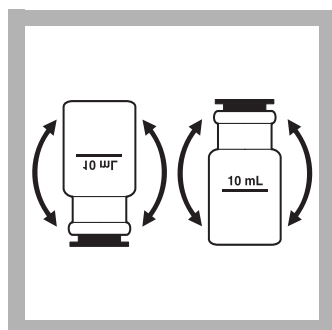

9. After the timer expires, cap and **gently invert the prepared sample twice. Avoid excessive mixing, or low results may occur.**



10. Wipe the prepared sample and insert it into the cell holder with the fill line facing right.

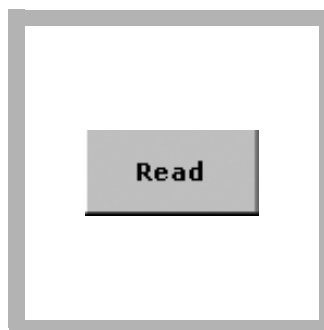

11. Press READ.
Results are in mg/L NO₂⁻.

Interferences

This test does not measure nitrates nor is it applicable to glycol-based samples. Dilute glycol-based samples and follow the Low Range Nitrite procedure, Method 8507.

Sample Collection, Storage, and Preservation

Collect samples in clean plastic or glass bottles.

The following storage instructions are necessary only when prompt analysis is impossible. Store at 4 °C (39 °F) or lower if the sample is to be analyzed within 24 to 48 hours. Warm to room temperature before running the test. Do not use acid preservatives.

Accuracy Check

Standard Solution Method

Preparing nitrite standards is difficult. Use the standard preparation instructions in *Standard Methods for the Examination of Water and Wastewater*. Prepare a 200-mg/L standard using Sodium Nitrite, ACS*, reagent grade.

Summary of Method

The method uses ferrous sulfate in an acidic medium to reduce nitrite to nitrous oxide. Ferrous ions combine with the nitrous oxide to form a greenish-brown complex in direct proportion to the nitrite present. Test results are measured at 585 nm.

Consumables and Replacement Items

Required Reagents

Description	Quantity/Test	Unit	Cat. No.
NitriVer® 2 Nitrite Reagent Powder Pillows	1	100/ pkg	21075-69
Water, deionized	varies	4 L	272-56

Required Apparatus

Description	Quantity/Test	Unit	Cat. No.
Sample Cells, 1-inch square. 10-mL matched pair	2	2/pkg	24954-02
Stopper, Neoprene, solid #1	2	12/pkg	14808-01

Optional Reagents and Apparatus

Description	Cat. No.
Balance, Analytical SA80 115 VAC	28014-01
Sodium Nitrite, ACS	2452-01

* See [Optional Reagents and Apparatus on page 3](#).



FOR TECHNICAL ASSISTANCE, PRICE INFORMATION AND ORDERING:

In the U.S.A. – Call toll-free 800-227-4224
Outside the U.S.A. – Contact the HACH office or distributor serving you.
On the Worldwide Web – www.hach.com; E-mail – techhelp@hach.com

HACH COMPANY
WORLD HEADQUARTERS
Telephone: (970) 669-3050
FAX: (970) 669-2932

Scope and Application: For wastewater, drinking water, surface water and mineral water



Test Preparation

Before starting the test:

Important Note: Install the light shield in Cell Compartment #2 before performing this test.

Please read Safety Advice and Expiration Date on the reagent package.

Recommended sample and reagent temperature is 15–25 °C (59–77 °F).

Recommended sample pH is between 3–10.

Recommended reagent storage temperature is 2–8 °C (35.6–46.4 °F).

TNTplus methods are activated directly from the Main Menu when the sample vial is inserted into the sample cell holder.

Collect the following items:

Quantity

TNT 839 Reagent Set	1
Light Shield	1
Pipettor for 2.0 mL Sample	1
Pipettor Tip	1

Note: Reorder information for consumables and replacement items is on page 4.

TNTplus

Method 10207

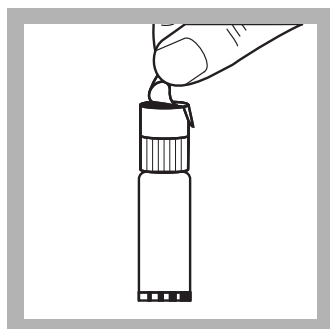

1. Carefully remove the protective foil lid from the DosiCap™ Zip. Unscrew the cap from the vial.

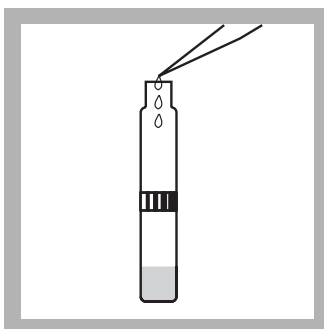

2. Carefully pipet 2.0 mL of sample into the vial. Immediately proceed to step 3.

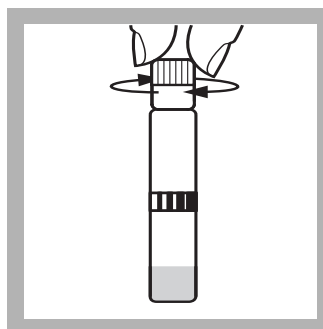

3. Flip the DosiCap Zip over so that the reagent side faces the vial. Screw the cap tightly onto the vial.

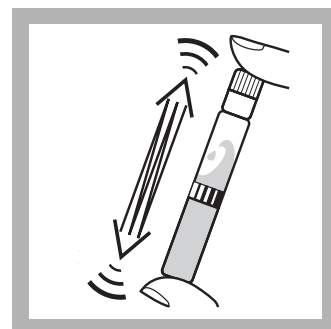

4. Shake the capped vial 2–3 times to dissolve the reagent in the cap.

Verify that the reagent has dissolved by looking down through the open end of the DosiCap Zip.



5. Wait 10 minutes.
Install the Light Shield in
Cell Compartment #2.

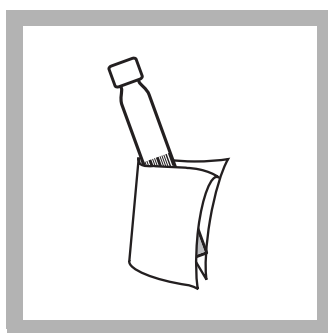

6. After 10 minutes,
thoroughly clean the
outside of the vial.

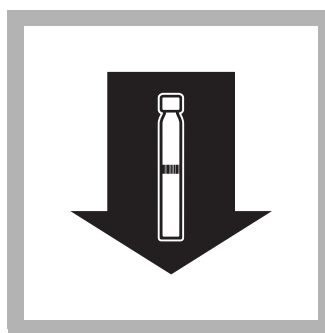

7. Insert the prepared
vial into the cell holder.
The instrument reads the
barcode, then selects and
performs the correct test.
Results are in mg/L
NO₂⁻-N

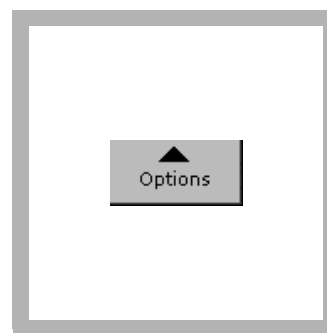

Note: Press
OPTIONS>MORE>
CHEMICAL FORMS to
obtain results in other
chemical forms.

Reagent Blanks

A reagent blank can be measured and the value subtracted from the results of each test performed in same reagent lot. Use deionized water in place of sample and run the procedure as described.

To subtract the value of the blank from a series of measurements, measure the blank per step 7. Press **OPTIONS>MORE>REAGENT BLANK**. Press **ON**. The measured value of the blank should be displayed in the highlighted box. Press **OK** to accept this value. The reagent blank value will now be subtracted from all results until the function is turned off, or a different method is selected. Alternately, the blank can be recorded and entered at any later time by pressing the highlighted box and using the keypad to enter the value.

Sample Blanks

Colored or turbid samples can cause high results. To compensate for color or turbidity the procedure is repeated and the color forming reagent that is present in the DosiCap **Zip** is not added.

To determine the sample blank run the procedure as given, but do not remove the foil from the DosiCap **Zip** in step 1 and replace the cap in its original position in step 3. The value obtained in step 7 is then subtracted from the value obtained on the original sample to give the corrected sample concentration.

Samples without color or turbidity do not require sample blanks.

Interferences

The ions listed in [Table 1](#) have been individually tested up to the given concentrations and do not cause interference. The cumulative effects of these ions or the influence of other ions have not been determined.

Table 1 Interfering Substances and Levels

Interfering Substances	Interference Levels
Cl ⁻ , SO ₄ ²⁻	2000 mg/L
K ⁺ , NO ₃ ⁻	1000 mg/L
NH ₄ ⁺ , PO ₄ ³⁻ , Ca ²⁺	500 mg/L
Mg ²⁺	100 mg/L
Cr ³⁺	50 mg/L
Co ²⁺ , Zn ²⁺ , Cd ²⁺ , Mn ²⁺ , Hg ²⁺	25 mg/L
Ni ²⁺	12 mg/L
Ag ⁺ , Fe ²⁺	10 mg/L
Sn ⁴⁺ , Fe ³⁺	5 mg/L
Cu ²⁺	< 1 mg/L

Sample Collection, Storage, and Preservation

Collect samples in clean plastic or glass bottles. Store at 4 °C (30 °F) or lower if the sample is to be analyzed within 24 to 48 hours. Warm to 15–25 °C (59–77 °F) before running the test. Do not use acid preservatives.

Accuracy Check

Standard Solution Method

Preparing nitrite standards is difficult. Use the standard preparation instructions in *Standard Methods for the Examination of Water and Wastewater*, Method 4500—NO₂-B. Prepare a 0.30-mg/L NO₂-N standard.

Summary of Method

Nitrite in the sample reacts with a primary aromatic amine in acidic solution to form a diazonium salt. This couples with an aromatic compound to form a colored complex that is directly proportional to the amount of nitrite present. Test results are measured at 515 nm.

Consumables and Replacement Items

Required Reagents

Description	Quantity/Test	Unit	Cat. No.
Nitrite, TNT 839 TNTplus™ Reagent Set	1	25/pkg	TNT839

Required Apparatus

Description	Quantity/Test	Unit	Cat. No.
Light Shield	1	each	LZV646
Pipet, variable volume, 1–5 mL	1	each	27951-00
Pipet Tips, for 27951-00 pipet	1	100/pkg	27952-00

Recommended Standards and Apparatus

Description	Unit	Cat. No.
Balance, analytical, SA80, 115 VAC	each	28014-01
Handbook, Standard Methods for the Examination of Water and Wastewater	each	22708-00
Sodium Nitrite, ACS	454 g	2452-01
Water, deionized	4 L	272-56

Optional Reagents and Apparatus

Description	Unit	Cat. No.
Bottle, sampling, low density poly, w/cap, 500 mL	12/pkg	20870-79
Test Tube Rack for 13-mm vials		



FOR TECHNICAL ASSISTANCE, PRICE INFORMATION AND ORDERING:
 In the U.S.A. – Call toll-free 800-227-4224
 Outside the U.S.A. – Contact the HACH office or distributor serving you.
 On the Worldwide Web – www.hach.com; E-mail – techhelp@hach.com

HACH COMPANY
 WORLD HEADQUARTERS
 Telephone: (970) 669-3050
 FAX: (970) 669-2932

Nitrogen, Ammonia

Method 8155

Powder Pillows

Salicylate Method¹

(0.01 to 0.50 mg/L NH₃-N)

Scope and Application: For water, wastewater, and seawater

¹ Adapted from *Clin. Chim. Acta.*, 14, 403 (1966)



Test Preparation

Collect the following items:

	Quantity
Ammonia Cyanurate Reagent pillows	2
Ammonia Salicylate Reagent pillows	2
Sample Cells, 1-inch square, 10-mL	2

Note: Reorder information for consumables and replacement items is on page 5.

Note: A green color will develop if ammonia nitrogen is present.

Powder Pillows

Method 8155



1. Press
STORED PROGRAMS.

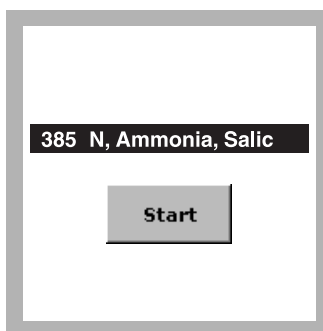

1. Select the test.

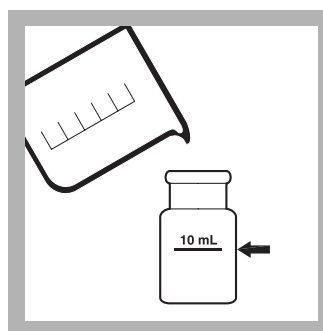

2. Prepared Sample:
Fill a square sample cell to the 10-mL mark with sample.

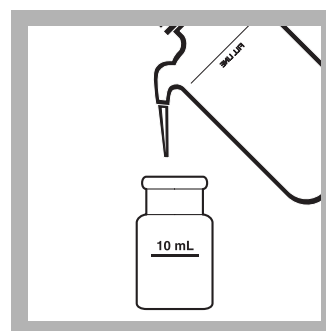

3. Blank Preparation:
Fill a second square sample cell to the 10-mL mark with deionized water.

(0.01 to 0.50 mg/L NH₃-N)

Nitrogen, Ammonia (0.01 to 0.50 mg/L NH₃-N)

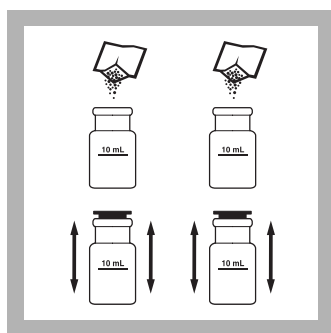

4. Add the contents of one Ammonia Salicylate Powder Pillow to each cell.

Stopper and shake to dissolve.

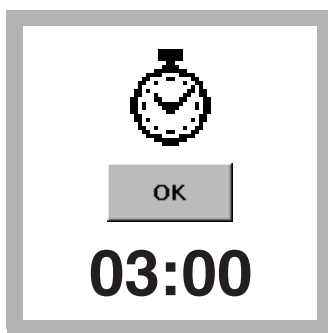

5. Press **TIMER>OK**. A three-minute reaction period will begin.

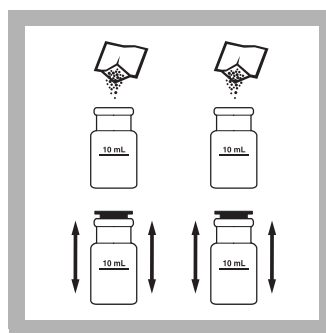

6. When the timer expires, add the contents of one Ammonia Cyanurate Reagent Powder Pillow to each cell.

Stopper and shake to dissolve.

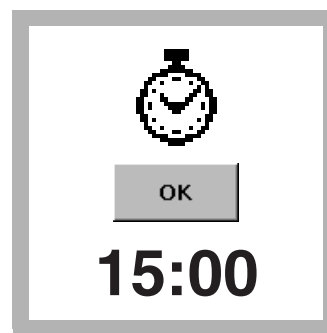

7. Press **TIMER>OK**. A 15-minute reaction period will begin.

A green color will develop if ammonia-nitrogen is present.



8. When the timer expires, insert the blank into the cell holder with the fill line facing right.

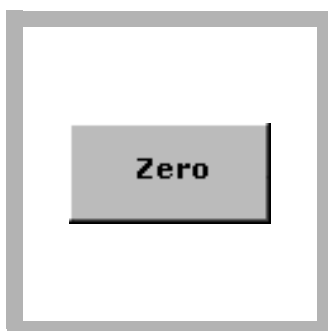

9. Press **ZERO**. The display will show: 0.00 mg/L NH₃-N



10. Wipe the sample and insert it into the cell holder with the fill line facing right.

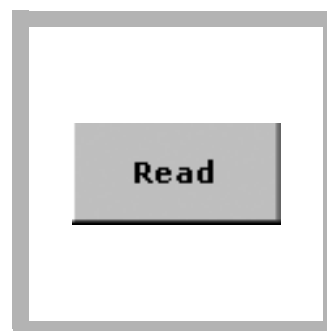

11. Press **READ**. Results are in mg/L NH₃-N.

Interferences

Table 1 Interfering Substances and Levels

Interfering Substance	Interference Levels and Treatments
Calcium	Greater than 1000 mg/L as CaCO ₃
Iron	All levels. Correct for iron interference as follows: <ol style="list-style-type: none"> 1. Determine the amount of iron present in the sample by following one of the Iron, Total, procedures. 2. Add the same iron concentration to the ammonia-free water in step 3. The interference will be successfully blanked out.
Magnesium	Greater than 6000 mg/L as CaCO ₃
Monochloramine	Monochloramine present in chloraminated drinking water interferes directly at all levels, giving high results. Use Method 10200, Free Ammonia and Monochloramine, to determine free ammonia in these sample matrices.
Nitrate	Greater than 100 mg/L as NO ₃ ⁻ -N
Nitrite	Greater than 12 mg/L as NO ₂ ⁻ -N
Phosphate	Greater than 100 mg/L as PO ₄ ³⁻ -P
Sulfate	Greater than 300 mg/L as SO ₄ ²⁻
Sulfide	Sulfide will intensify the color. Eliminate sulfide interference as follows: <ol style="list-style-type: none"> 1. Measure about 350 mL of sample in a 500-mL Erlenmeyer flask¹. 2. Add the contents of one Sulfide Inhibitor Reagent¹ Powder Pillow. Swirl to mix. 3. Filter the sample through a Folded Filter Paper¹ and Filter Funnel¹. 4. Use the filtered solution in step 3.
Other Substances	Less common interferences such as hydrazine and glycine will cause intensified colors in the prepared sample. Turbidity and color will give erroneous high values. Samples with severe interferences require distillation. Use the distillation procedure with the General Purpose Distillation Set.

¹ See [Optional Reagents and Apparatus](#) on page 5.

Sample Collection, Storage, and Preservation

Collect samples in clean plastic or glass bottles. Most reliable results are obtained when samples are analyzed as soon as possible after collection.

Adjust the pH to 2 or less with concentrated (about 2 mL per liter) Sulfuric Acid. Store samples at 4 °C or less. Samples preserved in this manner can be stored up to 28 days. Just before testing the stored sample, warm to room temperature and neutralize with 5.0 N Sodium Hydroxide Standard Solution. Correct the test result for volume additions.

Accuracy Check

1. After reading test results, leave the sample cell (unspiked sample) in the instrument.
2. Press **OPTIONS>MORE**. Press **STANDARD ADDITIONS**. A summary of the standard additions procedure will appear.
3. Press **OK** to accept the default values for standard concentration, sample volume, and spike volumes. Press **EDIT** to change these values. After values are accepted, the unspiked sample reading will appear in the top row. See the user manual for more information.

4. Open an Ammonia Nitrogen Standard Solution, 10-mg/L as NH₃-N.
5. Prepare three sample spikes. Fill three mixing cylinders with 25 mL of sample. Use the TenSette® Pipet to add 0.2 mL, 0.4 mL, and 0.6 mL of standard, respectively to the cylinders and mix each thoroughly.
6. Analyze each sample spike as described in the procedure above, starting with the 0.2 mL sample spike. Accept each standard additions reading by pressing **READ**. Each addition should reflect approximately 100% recovery.
7. After completing the sequence, press **GRAPH** to view the best-fit line through the standard additions data points, accounting for matrix interferences. Press **IDEAL LINE** to view relationships between the sample spikes and the "Ideal Line" of 100% recovery.

Standard Solution Method

Prepare a 0.40 mg/L ammonia nitrogen standard as follows:

1. Diluting 4.00 mL of the Ammonia Nitrogen Standard Solution, 10-mg/L, to 100 mL with deionized water. Or, use the TenSette® Pipet to prepare a 0.40 mg/L ammonia nitrogen standard by diluting 0.8 mL of an Ammonia Nitrogen Voluette® Standard Solution, 50-mg/L as NH₃-N, to 100 mL with deionized water.
2. To adjust the calibration curve using the reading obtained with the standard solution, press **OPTIONS>MORE** on the current program menu. Press **STANDARD ADJUST**.
3. Press **ON**. Press **ADJUST** to accept the displayed concentration. If an alternate concentration is used, press the number in the box to enter the actual concentration, then press **OK**. Press **ADJUST**.

Summary of Method

Ammonia compounds combine with chlorine to form monochloramine. Monochloramine reacts with salicylate to form 5-aminosalicylate. The 5-aminosalicylate is oxidized in the presence of a sodium nitroprusside catalyst to form a blue-colored compound. The blue color is masked by the yellow color from the excess reagent present to give a final green-colored solution. Test results are measured at 655 nm.

Consumables and Replacement Items

Required Reagents

Description	Quantity/Test	Unit	Cat. No.
Ammonia Nitrogen Reagent Set for 10-mL samples (100 tests), includes:	—	—	26680-00
Includes:			
(2) Ammonia Cyanurate Reagent Powder Pillows	2	100/pkg	26531-99
(2) Ammonia Salicylate Reagent Powder Pillows	2	100/pkg	26532-99

Required Apparatus

Description	Quantity/Test	Unit	Cat. No.
Sample Cells, 1-inch square, 10-mL, matched pair	2	2/pkg	24954-02

Recommended Standards and Apparatus

Description	Unit	Cat. No.
Nitrogen, Ammonia Standard Solution, 10-mg/L NH ₃ -N	500 mL	153-49
Nitrogen, Ammonia Standard Solution, 2-mL PourRite® Ampule, 50-mg/L NH ₃ -N	20/pkg	14791-20
Wastewater, Effluent Inorganics, for NH ₃ -N, NO ₃ -N, PO ₄ , COD, SO ₄ , TOC	500 mL	28332-49
Pipet, TenSette® 0.1 - 1.0 mL	each	19700-01
Pipet Tips, for TenSette Pipet 19700-01	50/pkg	21856-96
Pipet Tips, for TenSette Pipet 19700-01	1000/pkg	21856-28
Flask, volumetric, Class A, 100 mL	each	14574-42
Pipet, volumetric, Class A, 4.00 mL	each	14515-04
Pipet Filler, safety bulb	each	14651-00
Water, deionized	4 L	272-56

Optional Reagents and Apparatus

Description	Cat. No.
Cylinder, mixing	20886-40
Distillation Set	22653-00
Erlenmeyer Flask	505-49
Filter Funnel	1083-67
Filter Paper	1894-57
Sodium Hydroxide Standard Solution, 5.0 N	2450-26
Sulfide Inhibitor Reagent Powder Pillow	2418-99
Sulfuric Acid	979-49



FOR TECHNICAL ASSISTANCE, PRICE INFORMATION AND ORDERING:

In the U.S.A. – Call toll-free 800-227-4224
Outside the U.S.A. – Contact the HACH office or distributor serving you.
On the Worldwide Web – www.hach.com; E-mail – techhelp@hach.com

HACH COMPANY
WORLD HEADQUARTERS
Telephone: (970) 669-3050
FAX: (970) 669-2932

Nitrogen, Ammonia

★ Method 8038

Nessler Method¹
(0.02 to 2.50 mg/L NH₃-N)

Scope and Application: For water, wastewater, and seawater; distillation is required for wastewater and seawater; USEPA accepted for wastewater analysis (distillation required); see [Distillation on page 4](#) of this procedure.

¹ Adapted from *Standard Methods for the Examination of Water and Wastewater 4500-NH₃ B & C*.



Test Preparation

Before starting the test:

For more accurate results, determine a reagent blank value for each new lot of reagent. Follow the procedure using deionized water instead of the sample. Subtract the reagent blank value from the final results or perform a reagent blank adjust. See the user manual for more information.

Nessler Reagent contains mercuric iodide. Both the sample and the blank will contain mercury (D009) at a concentration regulated as a hazardous waste by the Federal RCRA. Do not pour these solutions down the drain. Refer to a current MSDS for safe disposal and handling instructions.

Collect the following items:

Quantity

Ammonia Nitrogen Reagent set	1
Deionized Water	25 mL
Graduated Mixing Cylinders	2
Sample Cells, 1-inch square, 10-mL	2
Serological Pipet, 1-mL	2

Note: Reorder information for consumables and replacement items is on [page 5](#).

Note: Nessler Reagent is toxic and corrosive. Pipet carefully, using a pipet filler. When dispensing reagent from a dropper bottle, hold the bottle vertically. Do not hold the bottle at an angle.

Note: A yellow color will develop if ammonia is present. (The reagent will cause a faint yellow color in the blank.)

Nessler

Method 8038



1. Press
STORED PROGRAMS.

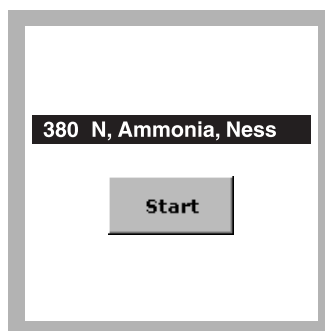

2. Select the test.

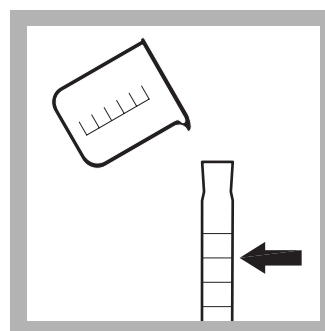

3. **Prepared Sample:**
Fill a 25-mL mixing graduated cylinder to the 25-mL mark with sample.

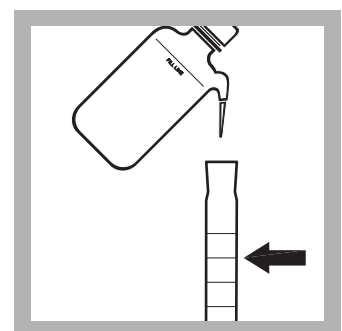

4. **Blank Preparation:**
Fill a 25-mL mixing graduated cylinder to the 25-mL mark with deionized water.

Nitrogen, Ammonia (0.02 to 2.50 mg/L NH₃-N)

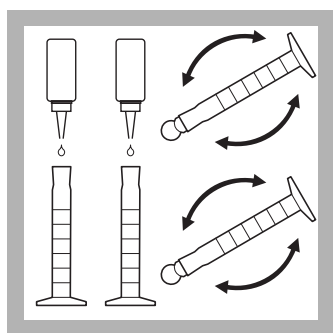

5. Add three drops of Mineral Stabilizer to each cylinder. Stopper and invert several times to mix.

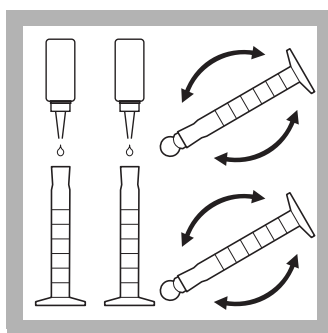

6. Add three drops of Polyvinyl Alcohol Dispersing Agent to each cylinder. Stopper and invert several times to mix.

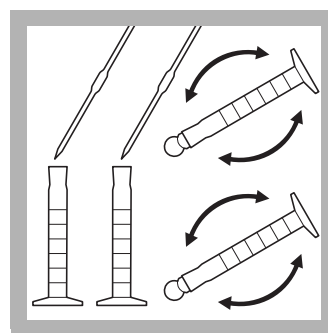

7. Pipet 1.0 mL of Nessler Reagent into each cylinder. Stopper and invert several times to mix.

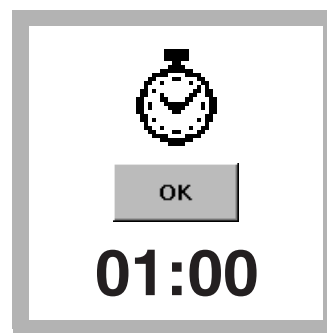

8. Press **TIMER>OK**.
A one-minute reaction period will begin.

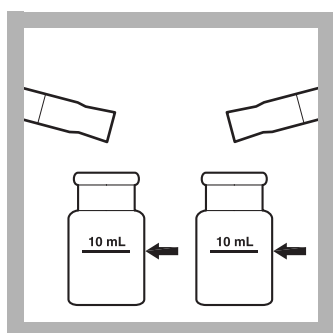

9. Pour 10 mL of each solution into a square sample cell.

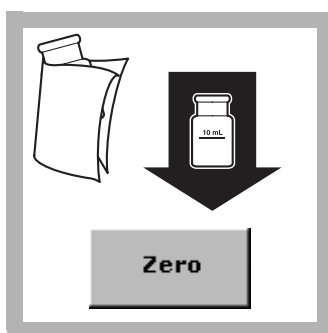

10. When the timer expires, insert the blank into the cell holder with the fill line facing right. Press **ZERO**. The display will show:
0.00 mg/L NH₃-N



11. Wipe the prepared sample and insert it into the cell holder with the fill line facing right.

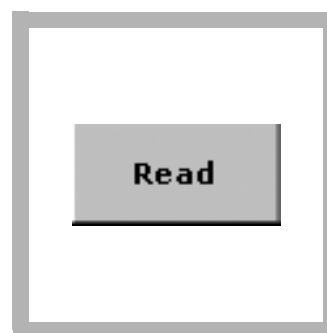

12. Press **READ**.
Results are in mg/L NH₃-N.

Interferences

Table 1 Interfering Substances and Levels

Interfering Substance	Interference Levels and Treatments
Chlorine	Remove residual chlorine by adding 2 drops of sodium arsenite for each mg/L chlorine (Cl ₂) from a 250 mL sample. Sodium thiosulfate can be used instead of sodium arsenite. See Sample Collection, Storage, and Preservation .
Hardness	A solution containing a mixture of 500 mg/L CaCO ₃ and 500 mg/L Mg as CaCO ₃ does not interfere. If the hardness concentration exceeds these concentrations, add extra Mineral Stabilizer.
Iron	Interferes at all levels by causing turbidity with Nessler Reagent.
Seawater	May be analyzed by adding of 1.0 mL (27 drops) of Mineral Stabilizer to the sample before analysis. This complexes the high magnesium concentrations found in sea water, but the sensitivity of the test is reduced by 30 percent due to the high chloride concentration. For best results, perform a calibration, using standards spiked to the equivalent chloride concentration, or distill the sample as described below.
Sulfide	Interferes at all levels by causing turbidity with Nessler Reagent.

Table 1 Interfering Substances and Levels (continued)

Interfering Substance	Interference Levels and Treatments
Glycine, various aliphatic and aromatic amines, organic chloramines, acetone, aldehydes and alcohols	May cause greenish or other off colors or turbidity. Distill the sample if these compounds are present.

Sample Collection, Storage, and Preservation

Collect samples in clean glass or plastic bottles. If chlorine is present, add one drop of 0.1 N Sodium Thiosulfate* for each 0.3 mg/L Cl₂ in a 1-liter sample. Preserve the sample by reducing the pH to 2 or less with sulfuric acid (at least 2 mL). Store at 4 °C (39 °F) or less. Preserved samples may be stored up to 28 days. Warm samples to room temperature and neutralize with 5 N Sodium Hydroxide* before analysis. Correct the test result for volume additions.

Accuracy Check

Standard Additions Method (Sample Spike)

1. After reading test results, leave the sample cell (unspiked sample) in the instrument.
2. Press **OPTIONS>MORE**. Press **STANDARD ADDITIONS**. A summary of the standard additions procedure will appear.
3. Press **OK** to accept the default values for standard concentration, sample volume, and spike volumes. Press **EDIT** to change these values. After values are accepted, the unspiked sample reading will appear in the top row. See the user manual for more information.
4. Snap the neck off a Nitrogen Ammonia Voluette® Ampule Standard, 50-mg/L NH₃-N.
5. Prepare three sample spikes. Fill three mixing cylinders with 25 mL of sample. Use the TenSette® Pipet to add 0.1 mL, 0.2 mL, and 0.3 mL of the 50 mg/L standard, respectively, to each sample and mix thoroughly.
6. Analyze each sample spike as described in the procedure above, starting with the 0.1 mL sample spike. Accept each standard additions reading by pressing **READ**. Each addition should reflect approximately 100% recovery.
7. After completing the sequence, press **GRAPH** to view the best-fit line through the standard additions data points, accounting for the matrix interferences. Press **IDEAL LINE** to view the relationship between the sample spikes and the "Ideal Line" of 100% recovery.

Standard Solutions Method

1. To check accuracy, use a 1.0-mg/L Nitrogen Ammonia Standard Solution. Or, prepare a 1.0-mg/L ammonia nitrogen standard solution by pipetting 1.00 mL of Nitrogen Ammonia Voluette® Ampule Standard, 50-mg/L, into a 50-mL volumetric flask. Dilute to the mark with deionized water. Prepare this solution daily. Perform the Nessler procedure as described above.

* See [Optional Reagents and Apparatus on page 5](#).

2. To adjust the calibration curve using the reading obtained with the standard solution, press **OPTIONS>MORE** on the current program menu. Press **STANDARD ADJUST**.
3. Press **ON**. Press **ADJUST** to accept the displayed concentration. If an alternate concentration is used, press the number in the box to enter the actual concentration, then press **OK**. Press **ADJUST**.

Distillation

1. Measure 250 mL of sample into a 250-mL graduated cylinder and pour into a 400-mL beaker. Destroy chlorine, if necessary, by adding 2 drops of Sodium Arsenite Solution per mg/L Cl₂.
2. Add 25 mL of Borate Buffer Solution and mix. Adjust the pH to about 9.5 with 1 N sodium hydroxide solution. Use a pH meter.
3. Set up the General Purpose Distillation Apparatus as shown in the *Distillation Apparatus Manual*. Pour the solution into the distillation flask. Add a stir bar.
4. Use a graduated cylinder to measure 25 mL of deionized water into a 250-mL Erlenmeyer flask. Add the contents of one Boric Acid Powder Pillow. Mix thoroughly. Set the flask under the still drip tube. Elevate so the end of the tube is immersed in the solution.
5. Turn on the heater power switch. Set the stir control to 5 and the heat control to 10. Turn on the water and adjust to maintain a constant flow through the condenser.
6. Turn off the heater after collecting 150 mL of distillate. Immediately remove the collection flask to avoid sucking solution into the still. Measure the distillate to ensure 150 mL was collected (total volume = 175 mL).
7. Adjust the pH of the distillate to about 7 with 1 N sodium hydroxide. Use a pH meter.
8. Pour the distillate into a 250-mL volumetric flask; rinse the Erlenmeyer with deionized water. Add the rinsings to the volumetric flask. Dilute to the mark. Stopper. Mix thoroughly. Analyze as described above.

Summary of Method

The Mineral Stabilizer complexes hardness in the sample. The Polyvinyl Alcohol Dispersing Agent aids the color formation in the reaction of Nessler Reagent with ammonium ions. A yellow color is formed proportional to the ammonia concentration. Test results are measured at 425 nm.

Consumables and Replacement Items

Required Reagents

Description	Quantity/Test	Unit	Cat. No.
Ammonia Nitrogen Reagent Set, includes:	—	—	24582-00
Nessler Reagent	2 mL	500 mL	21194-49
Mineral Stabilizer	6 drops	50 mL SCDB	23766-26
Polyvinyl Alcohol Dispersing Agent	6 drops	50 mL SCDB	23765-26
Water, deionized	25 mL	4 L	272-56

Required Apparatus

Description	Quantity/Test	Unit	Cat. No.
Cylinder, graduated, mixing, 25-mL	2	each	20886-40
Pipet, serological, 1-mL	2	each	9190-02
Pipet Filler, safety bulb	1	each	14651-00
Sample Cells, 1-inch square, 10-mL, matched pair	2	2/pkg	24954-02

Recommended Standards and Apparatus

Description	Unit	Cat. No.
Flask, volumetric, Class A, 50 mL	each	14574-41
Nitrogen, Ammonia Standard Solution, 1-mg/L NH ₃ -N	500 mL	1891-49
Nitrogen, Ammonia Standard Solution, 10-mL Voluette® Ampule, 50-mg/L NH ₃ -N	16/pkg	14791-10
Pipet, TenSette® 0.1 - 1.0 mL	each	19700-01
Pipet Tips, for TenSette Pipet 19700-01	50/pkg	21856-96
Pipet Tips, for TenSette Pipet 19700-01	1000/pkg	21856-28
Pipet, volumetric, Class A, 1.00 mL	each	14515-35
Wastewater, Effluent Inorganics, for NH ₃ -N, NO ₃ -N, PO ₄ , COD, SO ₄ , TOC	500 mL	28332-49

Optional Reagents and Apparatus

Description	Cat. No.
Distillation Apparatus, General	22653-00
Heater and Support Apparatus, 115 VAC, 60 Hz	22744-00
Heater and Support Apparatus, 230 VAC, 50 Hz	22744-02
Mixing Cylinders	20886-40
Pour-Thru Cell Kit	59404-00
Sodium Thiosulfate, 0.1 N	323-32
Sodium Hydroxide, 5 N	2450-32



FOR TECHNICAL ASSISTANCE, PRICE INFORMATION AND ORDERING:

In the U.S.A. – Call toll-free 800-227-4224
Outside the U.S.A. – Contact the HACH office or distributor serving you.
On the Worldwide Web – www.hach.com; E-mail – techhelp@hach.com

HACH COMPANY
WORLD HEADQUARTERS
Telephone: (970) 669-3050
FAX: (970) 669-2932

Nitrogen, Ammonia

Method 10031

Salicylate Method

Test 'N Tube™ Vials

HR (0.4 to 50.0 mg/L NH₃-N)

Scope and Application: For water, wastewater, and seawater



Test Preparation

Before starting the test:

Important Note: Install the light shield in Cell Compartment #2 before performing this test.

Small sample sizes (such as 0.1 mL) may not be representative of the entire sample. Mix the sample well before testing or repeat the test, sampling from different portions of the sample.

Good safety habits and laboratory techniques should be used throughout the procedure. Consult the Material Safety Data Sheet (MSDS) for information specific to the reagent used.

Collect the following items:

Quantity

High Range Test 'N Tube AmVer™ Nitrogen Ammonia Reagent	2
Light Shield	1
Funnel, micro (for adding reagent)	1
Pipet, TenSette®, 0.1–1.0 mL	1
Pipet Tips, for TenSette Pipet	varies

Note: Reorder information for consumables and replacement items is on page 4.

Test 'N Tube

Method 10031

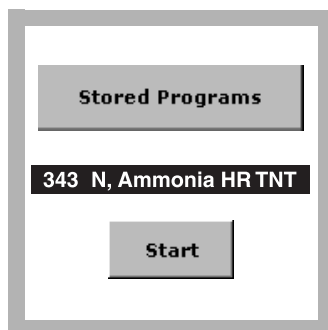

1. Select the test.

Install the Light Shield in Cell Compartment #2.

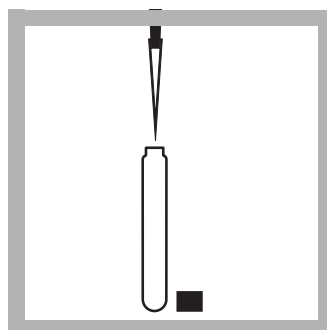

2. Prepared Sample:

Add 0.1 mL of sample to one AmVer™ Diluent Reagent Test 'N Tube for High Range Ammonia Nitrogen.

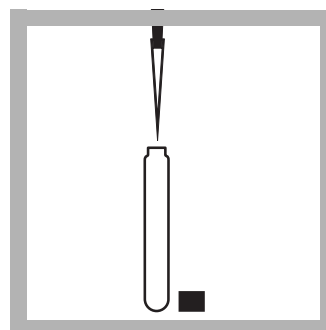

3. Blank Preparation:

Add 0.1 mL of ammonia-free water to one AmVer™ Diluent Reagent Test 'N Tube for High Range Ammonia Nitrogen.

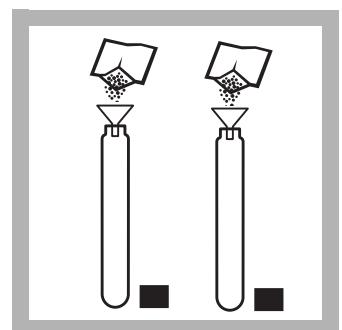

4. Add the contents of one Ammonia Salicylate Reagent Powder Pillow for 5 mL sample to each vial.

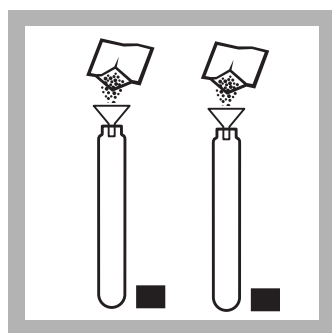

5. Add the contents of one Ammonia Cyanurate Reagent Powder Pillow to each vial.

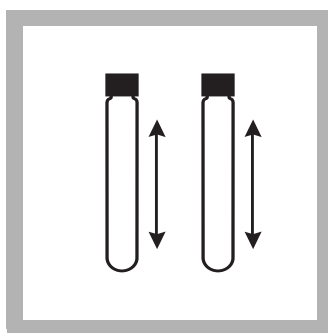

6. Cap the vials tightly and shake thoroughly to dissolve the powder.



7. Press **TIMER>OK**. A 20-minute reaction period will begin.

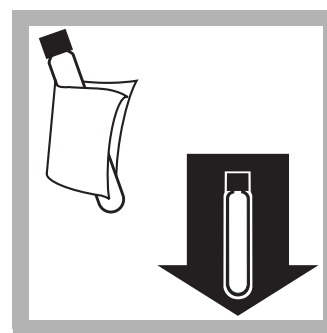

8. After the waiting period, wipe the blank and insert it into the 16-mm round cell holder.

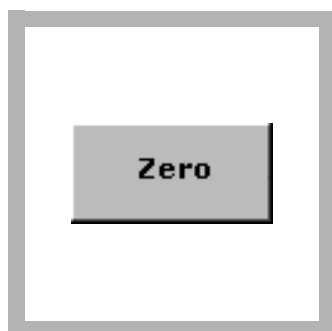

9. Press **ZERO**.

The display will show:
0.0 mg/L NH₃-N

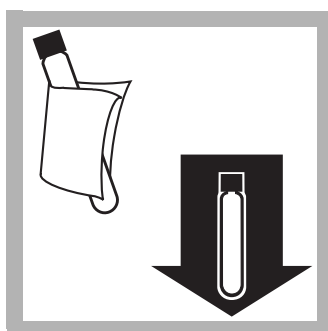

10. Wipe the sample vial and insert it into the 16-mm round cell holder.

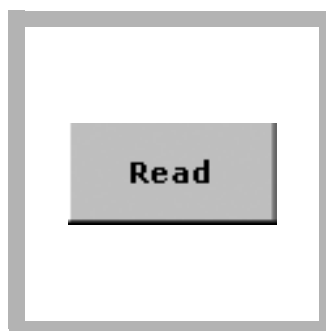

11. Press **READ**.

Results are in mg/L NH₃-N.

Interferences

In some lab environments, airborne cross contamination of the blank is possible. Complete preparation of the blank before opening or handling any samples or standards to avoid transfer of ammonia. If sample or standard containers have already been opened, move to a separate area of the lab to prepare the blank.

Table 1 Interfering Substances and Levels

Interfering Substance	Interference Levels and Treatments
Acidic or Basic Samples	Adjust to approximately pH 7. Use 1 N Sodium Hydroxide Standard Solution ¹ for acidic samples and 1 N Hydrochloric Acid Standard Solution for basic samples.
Calcium	50,000 mg/L as CaCO ₃
Glycine, hydrazine	Will cause intensified colors in the prepared sample.
Magnesium	300,000 mg/L as CaCO ₃
Monochloramine	Monochloramine present in chloraminated drinking water interferes directly at all levels giving high results. Use Method 10200, Free Ammonia and Monochloramine, to determine free ammonia in these sample matrices.
Iron	Eliminate iron interference as follows: <ol style="list-style-type: none"> Determine the amount of iron present in the sample using one of the total iron procedures. Add the same iron concentration to the deionized water in step 3. The interference will then be successfully blanked out.

Table 1 Interfering Substances and Levels (continued)

Interfering Substance	Interference Levels and Treatments
Nitrite	600 mg/L as NO ₂ ⁻ -N
Nitrate	5000 mg/L as NO ₃ ⁻ -N
Orthophosphate	5000 mg/L as PO ₄ ³⁻ -P
Sulfate	6000 mg/L as SO ₄ ²⁻
Sulfide	Sulfide will intensify the color. Eliminate sulfide interference as follows: <ol style="list-style-type: none"> 1. Measure about 350 mL of sample in a 500-mL Erlenmeyer flask. 2. Add the contents of one Sulfide Inhibitor Reagent Powder Pillow¹. Swirl to mix. 3. Filter the sample through folded filter paper¹. Use the solution in step 2.
Turbidity and color	Give erroneous high values. Samples with severe interferences require distillation. The manufacturer recommends the distillation procedure using the General Purpose Distillation Set.

¹ See [Optional Reagents and Apparatus on page 4](#).

Sample Collection, Storage, and Preservation

Collect samples in clean plastic or glass bottles. Best results are obtained with immediate analysis. Preserve samples by reducing the pH to 2 or less with at least 2 mL of Hydrochloric Acid. Store at 4 °C (39 °F) or less. Preserved samples may be stored up to 28 days. Warm samples to room temperature. Neutralize to a pH of 7.0 with 5.0 N Sodium Hydroxide before analysis. Correct the test result for volume additions.

Accuracy Check

Standard Additions Method (Sample Spike)

1. After reading test results, leave the sample cell (unspiked sample) in the instrument.
2. Press **OPTIONS>MORE**. Press **STANDARD ADDITIONS**. A summary of the standard additions procedure will appear.
3. Press **OK** to accept the default values for standard concentration, sample volume, and spike volumes. Press **EDIT** to change these values. After values are accepted, the unspiked sample reading will appear in the top row. See the user manual for more information.
4. Snap the neck off a Nitrogen, Ammonia PourRite® Ampule Standard, 150-mg/L NH₃-N.
5. Prepare three sample spikes. Fill three mixing cylinders with 25 mL of sample. Use the TenSette® Pipet to add 0.2, 0.4 mL, and 0.6 mL of standard, respectively, to each sample and mix each thoroughly.
6. Analyze each sample spike as described in the procedure above, starting with the 0.2 mL sample spike. Accept each standard additions reading by pressing **READ**. Each addition should reflect approximately 100% recovery.
7. After completing the sequence, press **GRAPH** to view the best-fit line through the standard additions data points, accounting for matrix interferences. Press **IDEAL LINE** to view relationships between the sample spikes and the "Ideal Line" of 100% recovery.

Standard Solution Method

1. To check accuracy, prepare a 40.0-mg/L ammonia nitrogen standard solution by pipetting 20.00 mL of 100-mg/L Ammonia Nitrogen standard into a 50-mL, Class A volumetric flask. Dilute to the mark with deionized water.

Nitrogen, Ammonia HR (0.4 to 50.0 mg/L NH₃-N)

- To adjust the calibration curve using the reading obtained with the standard solution, press **OPTIONS>MORE** on the current program menu. Press **STANDARD ADJUST**.
- Press **ON**. Press **ADJUST** to accept the displayed concentration. If an alternate concentration is used, press the number in the box to enter the actual concentration, then press **OK**. Press **ADJUST**.

Summary of Method

Ammonia compounds combine with chlorine to form monochloramine. Monochloramine reacts with salicylate to form 5-aminosalicylate. The 5-aminosalicylate is oxidized in the presence of a sodium nitroprusside catalyst to form a blue colored compound. The blue color is masked by the yellow color from the excess reagent present to give a green-colored solution. Test results are measured at 655 nm.

Consumables and Replacement Items

Required Reagents

Description	Unit	Cat. No.
Reagent Set, High Range Test 'N Tube™ AmVer™ Nitrogen Ammonia	50 tests	26069-45

Required Apparatus

Description	Unit	Cat. No.
Funnel, micro (for adding reagent)	each	25843-35
Light Shield	1 each	LZV646
Pipet, TenSette®, 0.1 to 1.0 mL	each	19700-01
Pipet Tips, for TenSette® Pipet 19700-01	50/pkg	21856-96

Recommended Standards and Apparatus

Description	Unit	Cat. No.
Nitrogen Ammonia Standard Solution, 10-mg/L NH ₃ -N	500 mL	153-49
Nitrogen Ammonia Standard Solution, 100-mg/L NH ₃ -N	500 mL	24065-49
Nitrogen Ammonia Standard Solution, 150-mg/L NH ₃ -N, 10-mL PourRite® Ampules	16/pkg	21284-10
Nitrogen Ammonia Standard Solution, 50-mg/L NH ₃ -N, 10-mL Voluette® Ampules	16/pkg	14791-10
Pipet Tips, for TenSette Pipet 19700-01	1000/pkg	21856-28
Wastewater, Effluent Inorganics Standard, for NH ₃ -N, NO ₃ -N, PO ₄ , COD, SO ₄ , TOC	500 mL	28332-49
Water, deionized	4L	272-56

Optional Reagents and Apparatus

Description	Cat. No.
Cylinders, mixing	20886-40
Distillation Set, general purpose	22653-00
Filter Paper	692-57
Hydrochloric Acid Standard Solution, 1 N	134-49
Sodium Hydroxide Standard Solution, 1 N	1045-32
Sulfide Inhibitor Reagent Powder Pillows	2418-99



FOR TECHNICAL ASSISTANCE, PRICE INFORMATION AND ORDERING:
In the U.S.A. – Call toll-free 800-227-4224
Outside the U.S.A. – Contact the HACH office or distributor serving you.
On the Worldwide Web – www.hach.com; E-mail – techhelp@hach.com

HACH COMPANY
WORLD HEADQUARTERS
Telephone: (970) 669-3050
FAX: (970) 669-2932

Nitrogen, Ammonia

Method 10023

Salicylate Method¹

Test 'N Tube™ Vials

LR (0.02 to 2.50 mg/L NH₃-N)

Scope and Application: For water, wastewater, and seawater

¹ Adapted from *Clin. Chim. Acta*, 14, 403 (1966)



Test Preparation

Before starting the test:

Important Note: Install the light shield in Cell Compartment #2 before performing this test.

Good safety habits and laboratory techniques should be used throughout the procedure. Consult the Material Safety Data sheet (MSDS) for information specific to the reagent used.

Collect the following items:

Quantity

Light Shield	1
Low Range Test 'N Tube AmVer™ Nitrogen Ammonia Reagent	2
Funnel, micro (for adding reagent)	1
TenSette® Pipet, 1.0–10.0 mL	1
Pipet Tips for TenSette Pipet	varies

Note: Reorder information for consumables and replacement items is on page 4.

Test 'N Tube

Method 10023

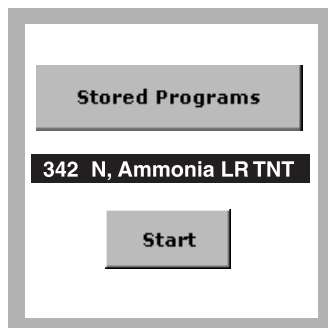

1. Select the test.

Install the Light Shield in Cell Compartment #2.

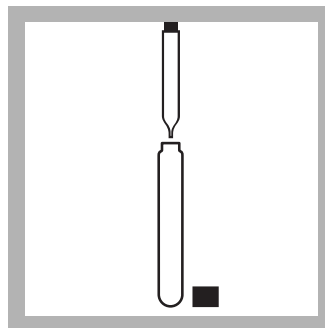

2. **Prepared Sample:**

Add 2.0 mL of sample to one AmVer™ Diluent Reagent Test 'N Tube™ for Low Range Ammonia Nitrogen.

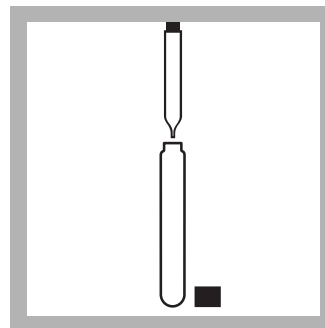

3. **Blank Preparation:**

Add 2.0 mL of ammonia-free water to another AmVer™ Diluent Reagent Test 'N Tube for Low Range Ammonia Nitrogen.

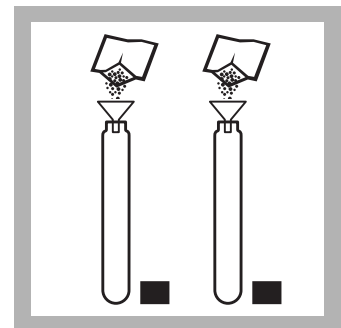

4. Add the contents of one Ammonia Salicylate Reagent Powder Pillow to each vial.

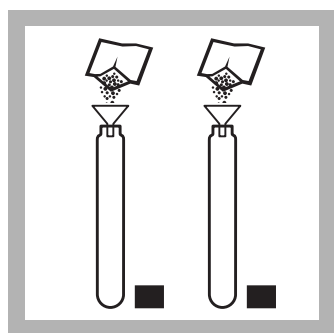

5. Add the contents of one Ammonia Cyanurate Reagent Powder Pillow to each vial.

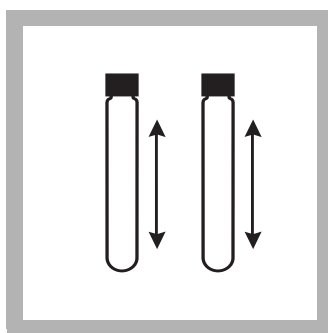

6. Cap the vials tightly and shake thoroughly to dissolve the powder.



7. Press **TIMER>OK**. A 20-minute reaction period will begin.

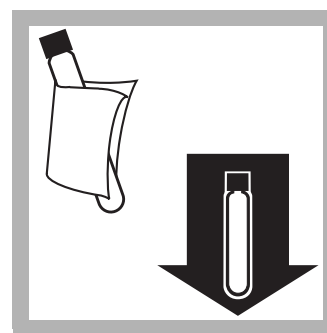

8. After the waiting period, wipe the blank and insert it into the 16-mm round cell holder.

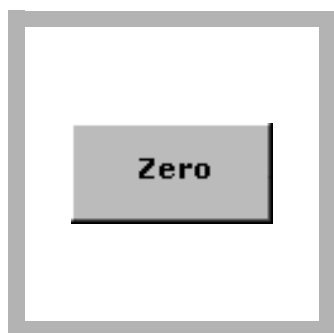

9. Press **ZERO**. The display will show: 0.00 mg/L NH₃-N

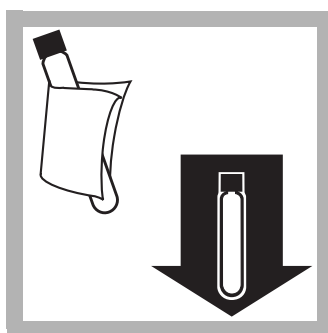

10. Wipe the sample vial and insert it into the 16-mm round cell holder.

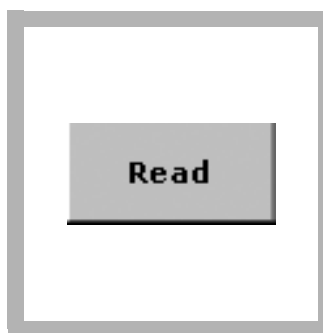

11. Press **READ**.
Results are in mg/L NH₃-N.

Interference

Table 1 Interfering Substances and Levels

Interfering Substance	Interference Levels and Treatments
Calcium	2500 mg/L as CaCO ₃
Iron	Determine the amount of iron present in the sample by using one of the Iron, Total, procedures. Add the same iron concentration to the ammonia-free water in step 3. The interference will then be successfully blanked out.
Magnesium	15,000 mg/L as CaCO ₃
Monochloramine	Monochloramine present in chloraminated drinking water Interferes directly at all levels giving high results. Use Method 10200, Free Ammonia and Monochloramine, to determine free ammonia in these sample matrices.
Nitrite	30 mg/L as NO ₂ ⁻ -N
Nitrate	250 mg/L as NO ₃ ⁻ -N
Orthophosphate	250 mg/L as PO ₄ ³⁻ -P
pH	Acidic or basic samples should be adjusted to approximately pH 7. Use 1 N Sodium Hydroxide Standard Solution ¹ for acidic samples and 1 N Hydrochloric Acid Standard Solution ¹ for basic samples.
Sulfate	300 mg/L as SO ₄ ²⁻

Table 1 Interfering Substances and Levels (continued)

Interfering Substance	Interference Levels and Treatments
Sulfide	<ol style="list-style-type: none"> 1. Measure about 350 mL of sample in a 500-mL Erlenmeyer flask. 2. Add the contents of one Sulfide Inhibitor Reagent Powder Pillow¹. Swirl to mix. 3. Filter the sample through a folded filter paper¹. 4. Use the filtered solution in step 3.
Other	Less common interferences such as hydrazine and glycine will cause intensified colors in the prepared sample. Turbidity and color will give erroneous high values. Samples with severe interferences require distillation. Use the distillation procedure with the General Purpose Distillation Set.

¹ See [Optional Reagents and Apparatus on page 4](#).

Sample Collection, Storage, and Preservation

Collect samples in clean plastic or glass bottles. Best results are obtained with immediate analysis. Preserve the samples by reducing the pH to 2 or less with at least 2 mL of Hydrochloric Acid. Store at 4 °C (39 °F) or less. Preserved samples may be stored up to 28 days. Before analysis, warm samples to room temperature and neutralize to pH 7.0 with 5.0 N Sodium Hydroxide. Correct the test result for volume additions.

Accuracy Check

Standard Additions Method (Sample Spike)

1. After reading test results, leave the sample cell (unspiked sample) in the instrument.
2. Press **OPTIONS>MORE**. Press **STANDARD ADDITIONS**. A summary of the standard additions procedure will appear.
3. Press **OK** to accept the default values for standard concentration, sample volume, and spike volumes. Press **EDIT** to change these values. After values are accepted, the unspiked sample reading will appear in the top row. See the user manual for more information.
4. Snap the neck off an Ammonia Nitrogen Ampule Standard*, 50-mg/L as NH₃-N.
5. Prepare three sample spikes. Fill three mixing cylinders* with 25 mL of sample. Use the TenSette® Pipet to add 0.1 mL, 0.2 mL, and 0.3 mL of standard, respectively, to each sample and mix thoroughly.
6. Analyze each sample spike as described in the procedure above, starting with the 0.1 mL sample spike. Accept each standard additions reading by pressing **READ**. Each addition should reflect approximately 100% recovery.
7. After completing the sequence, press **GRAPH** to view the best-fit line through the standard additions data points, accounting for matrix interferences. Press **IDEAL LINE** to view relationships between the sample spikes and the "Ideal Line" of 100% recovery.

Standard Solution Method

1. To check accuracy, use the Nitrogen Ammonia Standard Solution, 1.0 mg/L. Or, dilute 1 mL of 50-mg/L Nitrogen Ammonia Standard Solution to 50 mL with deionized water in a 50-mL volumetric flask to prepare a 1.0 mg/L solution.
2. To adjust the calibration curve using the reading obtained with the standard solution, press **OPTIONS>MORE** on the current program menu. Press **STANDARD ADJUST**.

* See [Optional Reagents and Apparatus on page 4](#).

Nitrogen, Ammonia LR (0.02 to 2.50 mg/L NH₃-N)

- Press **ON**. Press **ADJUST** to accept the displayed concentration. If an alternate concentration is used, press the number in the box to enter the actual concentration, then press **OK**. Press **ADJUST**.

Summary of Method

Ammonia compounds combine with chlorine to form monochloramine. Monochloramine reacts with salicylate to form 5-aminosalicylate. The 5-aminosalicylate is oxidized in the presence of a sodium nitroprusside catalyst to form a blue colored compound. The blue color is masked by the yellow color from the excess reagent present to give a final green solution. Test results are measured at 655 nm.

Consumables and Replacement Items

Required Reagents

Description	Unit	Cat. No.
Reagent Set, Low Range Test 'N Tube™ AmVer™ Nitrogen Ammonia	25 tests	26045-45

Required Apparatus

Description	Quantity/Test	Unit	Cat. No.
Funnel, micro (for adding reagent)	1	each	25843-35
Light Shield	1	each	LZV646
Pipet, TenSette®, 1.0 to 10.0 mL	1	each	19700-10
Pipet Tips, for TenSette Pipet 19700-10	varies	50/pkg	21997-96
Tube Rack	1-3	each	18641-00

Recommended Standards and Apparatus

Description	Unit	Cat. No.
Nitrogen Ammonia Standard Solution, 1.0-mg/L NH ₃ -N	500 mL	1891-49
Nitrogen Ammonia Standard Solution, 50-mg/L NH ₃ -N, 10-mL Voluette® Ampules	16/pkg	14791-10
Pipet Tips, for TenSette Pipet 19700-10	250/pkg	21856-25
Wastewater, Effluent Inorganics Standard, for NH ₃ -N, NO ₃ -N, PO ₄ , COD, SO ₄ , TOC	500 mL	28332-49
Water, deionized	4L	272-56

Optional Reagents and Apparatus

Description	Cat. No.
Cylinders, mixing	20886-40
Distillation Set, general purpose	22653-00
Filter Funnel	1083-67
Filter Paper	1894-57
Hydrochloric Acid Standard Solution, 1 N	23213-53
Hydrochloric Acid, concentrated ACS	134-49
Sodium Hydroxide Standard Solution, 1 N	1045-32
Sulfide Inhibitor Reagent Powder Pillows	2418-99



FOR TECHNICAL ASSISTANCE, PRICE INFORMATION AND ORDERING:
In the U.S.A. – Call toll-free 800-227-4224
Outside the U.S.A. – Contact the HACH office or distributor serving you.
On the Worldwide Web – www.hach.com; E-mail – techhelp@hach.com

HACH COMPANY
WORLD HEADQUARTERS
Telephone: (970) 669-3050
FAX: (970) 669-2932

Nitrogen, Ammonia

Method 10205

Salicylate Method

TNTplus™ 830

ULR (0.015 to 2.000 mg/L NH₃-N)

Scope and Application: For municipal and industrial wastewaters, environmental waters, and watershed protection monitoring.



Test Preparation

Before starting the test:

Important Note: Install the light shield in Cell Compartment #2 before performing this test.

Please read Safety Advice and Expiration Date on package.

Recommended sample pH is 4–8.

Recommended sample and reagent temperature is 20–23 °C (68–73.4 °F). Incorrect results may be obtained if test is not performed at the recommended temperature.

Recommended reagent storage is 2–8 °C (35.6–46.4 °F).

Analyze samples as soon as possible for best results.

TNTplus methods are activated from the Main Menu screen when the sample vial is inserted into the sample cell holder.

Collect the following items:

Quantity

Nitrogen, Ammonia, TNT 830 Reagent Set	1 vial
Light Shield	1
Pipettor for 5.0 mL Sample	1
Pipettor Tip	varies

Note: Reorder information for consumables and replacement items is on page 4.

TNTplus

Method 10205

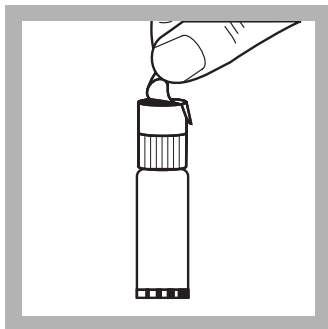

1. Carefully remove the protective foil lid from the DosiCap™ **Zip**. Unscrew the cap from the vial.

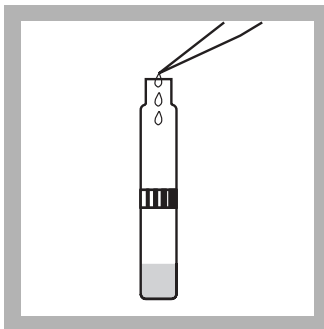

2. Carefully pipet 5.0 mL of sample into the vial. Immediately proceed to step 3.

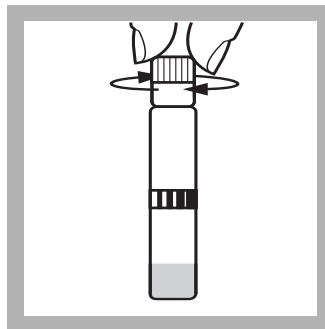

3. Flip the DosiCap **Zip** over so that the reagent side faces the vial. Screw the cap tightly onto the vial.

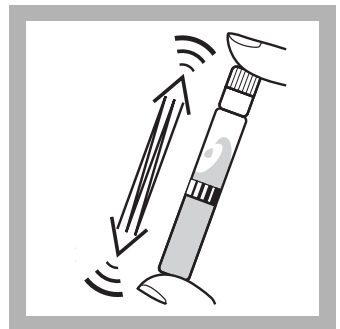

4. Shake the capped vial 2–3 times to dissolve the reagent in the cap.

Verify that the reagent has dissolved by looking down through the open end of the DosiCap **Zip**.



5. Wait 15 minutes.

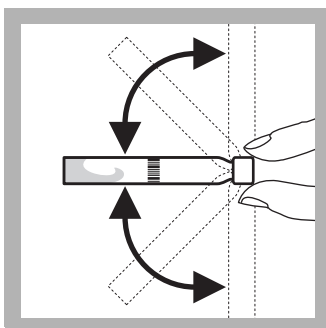

6. After 15 minutes, invert the sample an additional 2–3 times to mix.

The color remains constant for an additional 15 minutes after the timer expires.

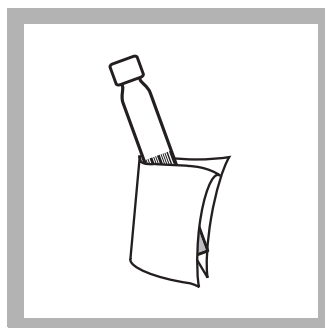

7. Thoroughly clean the outside of the vial.

Install the Light Shield in Cell Compartment #2.

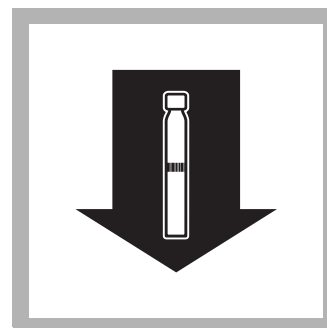

8. Insert the prepared vial into the cell holder.

The instrument reads the barcode, then selects and performs the correct test. Results are in mg/L NH₃-N.

No instrument Zero is required.

Reagent Blanks

A reagent blank can be measured, and the value subtracted from the results of each test performed using the same reagent lot number. Use deionized water in place of sample and run the procedure as described.

To subtract the value of the blank from a series of measurements, measure the blank per step 8. Press **OPTIONS>MORE>REAGENT BLANK**. Press **ON**. The measured value of the blank should be displayed in the highlighted box. Press **OK** to accept this value. The reagent blank value will now be subtracted from all results until the function is turned off, or a different method is selected. Alternately, the blank can be recorded and entered at any later time by pressing the highlighted box and using the keypad to enter the value.

Sample Blanks

Colored or turbid samples can cause high results. To compensate for color or turbidity the procedure is repeated and the color forming reagent that is present in the DosiCap **Zip** is not added.

To determine the sample blank run the procedure as given, but do not remove the foil from the DosiCap **Zip** in step 1 and replace the cap in its original position in step 3. The value obtained in step 8 is then subtracted from the value obtained on the original sample to give the corrected sample concentration.

Alternatively, samples that contain turbidity only may be first filtered through a membrane filter and then analyzed.

Interferences

The ions listed in [Table 1](#) have been individually checked up to the given concentrations and do not cause interference. Cumulative effects and the influence of other ions have not been determined.

Primary amines are determined and cause high-bias results. A 10000-fold excess of urea does not interfere. All reducing agents interfere and cause low-bias results.

Important Note: *An analyte concentration greatly in excess of the stated range will adversely affect color formation, resulting in a false reading within the method range.*

Measurement results can be verified using sample dilutions or standard additions.

Samples with severe interferences require distillation. The manufacturer recommends the distillation procedure using the Hach General Purpose Distillation Set.

Table 1 Interfering Substances and Levels

Interfering Substance	Interference Levels
Cl ⁻ , SO ₄ ²⁻	1000 mg/L
K ⁺ , Na ⁺ , Ca ²⁺	500 mg/L
CO ₃ ²⁻ , NO ₃ ⁻ , Fe ³⁺ , Cr ³⁺ , Cr ⁶⁺ , Zn ²⁺ , Cu ²⁺ , Co ²⁺ , Ni ²⁺ , Hg ²⁺	50 mg/L
Fe ²⁺	25 mg/L
Sn ²⁺	10 mg/L
Pb ²⁺	5 mg/L
Ag ⁺	2 mg/L

Sample Collection, Storage, and Preservation

Collect samples in clean plastic or glass bottles. Best results are obtained with immediate analysis. Preserve the samples by reducing the pH to 2 or less with at least 2 mL of Hydrochloric Acid. Store at 4 °C (39 °F) or less. Preserved samples may be stored up to 28 days. Before analysis, warm samples to 20–23 °C (68–73.4 °F) and neutralize to pH 7.0 with 5.0 N Sodium Hydroxide. Correct the test result for volume additions.

Accuracy Check

Standard Solution Method

1. Check the accuracy of the method with a 1.0 mg/L ammonia nitrogen standard. Use 5.0 mL of this 1.0 mg/L standard in place of the sample in step 2.
2. Alternately, use 5.0 mL of a Wastewater Effluent Mixed Parameters Inorganics Standard in place of the sample in step 2. This standard contains 2 mg/L ammonia nitrogen in the presence of other ions such as nitrate, phosphate and sulfate.

Summary of Method

Ammonium ions react at pH 12.6 with hypochlorite ions and salicylate ions in the presence of sodium nitroprusside as a catalyst to form indophenol. The amount of color formed is directly proportional to the ammonia nitrogen present in the sample. Test results are measured at 690 nm.

Consumables and Replacement Items**Required Reagents**

Description	Unit	Cat. No.
Ammonia, ULR TNT830 Reagent Set	25 tests	TNT830

Required Apparatus

Description	Quantity/Test	Unit	Cat. No.
Light Shield	1	each	LZV646
Pipettor, variable volume, 1-5 mL	1	each	27951-00
Pipettor Tips, for 27951-00 pipettor	1	100/pkg	27952-00

Recommended Standards and Apparatus

Description	Unit	Cat. No.
Nitrogen Ammonia Standard Solution, 1.0-mg/L NH ₃ -N	500 mL	1891-49
Wastewater, Effluent Inorganics Standard, for NH ₃ -N, NO ₃ -N, PO ₄ , COD, SO ₄ , TOC	500 mL	28332-49
Water, deionized	4L	272-56

Optional Reagents and Apparatus

Description	Cat. No.
Bottle, sampling, low density poly, w/cap, 500 mL, 12/pkg	20870-79
Distillation Set, general purpose	22653-00
Filter Holder, glass for vacuum filtration (SUVA)	2340-00
Filter membrane, 47-mm, 0.45-micron, hydrophilic, polyethersulfone for SUVA	28947-00
Flask, filtering, glass, 1000-mL (SUVA)	546-53
Hydrochloric Acid Standard Solution, 1 N	23213-53
Hydrochloric Acid, concentrated ACS	134-49
Sodium Hydroxide Standard Solution, 1 N	1045-32
Test Tube Rack for 13-mm vial	24979-00
Tubing, rubber, 12-ft	560-19



FOR TECHNICAL ASSISTANCE, PRICE INFORMATION AND ORDERING:
In the U.S.A. – Call toll-free 800-227-4224
Outside the U.S.A. – Contact the HACH office or distributor serving you.
On the Worldwide Web – www.hach.com; E-mail – techhelp@hach.com

HACH COMPANY
WORLD HEADQUARTERS
Telephone: (970) 669-3050
FAX: (970) 669-2932

Nitrogen, Ammonia

Method 10205

Salicylate Method

TNTplus™ 831

LR (1 to 12 mg/L NH₃-N)

Scope and Application: For surface waters, municipal and industrial wastewaters.



Test Preparation

Before starting the test:

Important Note: Install the light shield in Cell Compartment #2 before performing this test.

Please read Safety Advice and Expiration Date on package.

Recommended sample pH is 4–8.

Recommended sample and reagent temperature is 20–23 °C (68–73.4 °F). Incorrect results may be obtained if test is not performed at the recommended temperature.

Recommended reagent storage is 2–8 °C (35.6–46.4 °F).

Analyze samples as soon as possible for best results.

TNTplus methods are activated from the Main Menu when the sample vial is inserted into the sample cell holder.

Collect the following items:

Quantity

Ammonia, TNTplus LR TNT831 Reagent Set	1 vial
Light Shield	1
Pipettor for 0.5 mL sample	1
Pipettor Tip	varies

Note: Reorder information for consumables and replacement items is on page 4.

TNTplus

Method 10205

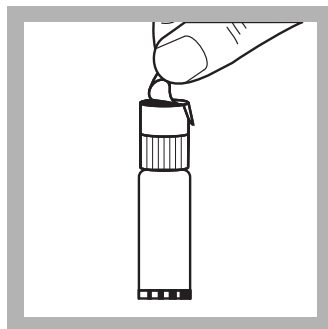

1. Carefully remove the protective foil lid from the DosiCap™ **Zip**. Unscrew the cap from the vial.

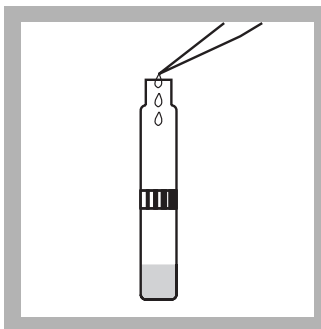

2. Carefully pipet 0.5 mL (500 µL) of sample into the vial. Immediately proceed to step 3.

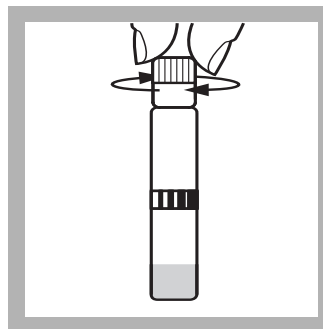

3. Flip the DosiCap **Zip** over so that the reagent side faces the vial. Screw the cap tightly onto the vial.

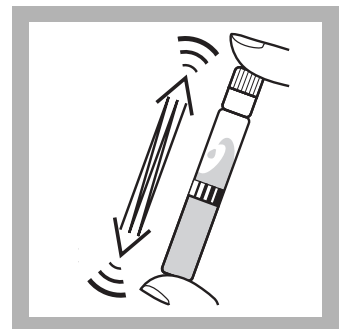

4. Shake the capped vial 2–3 times to dissolve the reagent in the cap.

Verify that the reagent has dissolved by looking down through the open end of the DosiCap **Zip**.



5. Wait 15 minutes.

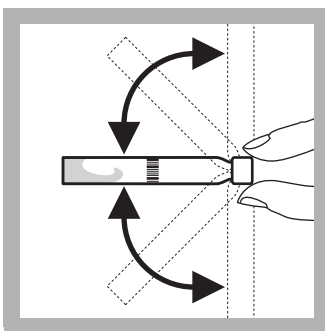

6. After 15 minutes, invert the sample an additional 2–3 times to mix.

The color remains constant for an additional 15 minutes after the timer expires.

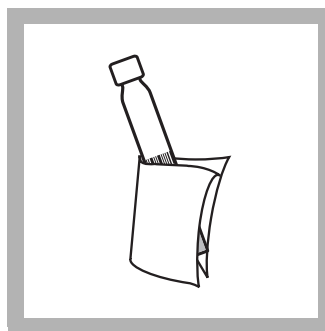

7. Thoroughly clean the outside of the vial.

Install the Light Shield in Cell Compartment #2.

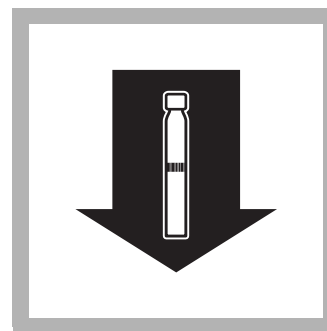

8. Insert the prepared vial into the cell holder.

The instrument reads the barcode, then selects and performs the correct test. Results are in mg/L NH₃-N.

No instrument Zero is required.

Reagent Blanks

A reagent blank can be measured, and the value subtracted from the results of each test performed using the same reagent lot number. Use deionized water in place of sample and run the procedure as described.

To subtract the value of the blank from a series of measurements, measure the blank per step 8. Press **OPTIONS>MORE>REAGENT BLANK**. Press **ON**. The measured value of the blank should be displayed in the highlighted box. Press **OK** to accept this value. The reagent blank value will now be subtracted from all results until the function is turned off, or a different method is selected. Alternately, the blank can be recorded and entered at any later time by pressing the highlighted box and using the keypad to enter the value.

Sample Blanks

Colored or turbid samples can cause high results. To compensate for color or turbidity the procedure is repeated and the color forming reagent that is present in the DosiCap **Zip** is not added.

To determine the sample blank run the procedure as given, but do not remove the foil from the DosiCap **Zip** in step 1 and replace the cap in its original position in step 3. The value obtained in step 8 is then subtracted from the value obtained on the original sample to give the corrected sample concentration.

Alternatively, samples that contain turbidity only may be first filtered through a membrane filter and then analyzed.

Samples without color or turbidity do not require sample blanks.

Interferences

The ions listed in [Table 1](#) have been individually checked up to the given concentrations and do not cause interference. Cumulative effects and the influence of other ions have not been determined.

Primary amines are determined and cause high-bias results. A 10000-fold excess of urea does not interfere. All reducing agents interfere and cause low-bias results.

Important Note: An analyte concentration greatly in excess of the stated range will adversely affect color formation, resulting in a false reading within the method range.

Measurement results can be verified using sample dilutions or standard additions.

Samples with severe interferences require distillation. The manufacturer recommends the distillation procedure using the Hach General Purpose Distillation Set.

Table 1 Interfering Substances and Levels

Interfering Substance	Interference Levels
Cl ⁻ , SO ₄ ²⁻	1000 mg/L
K ⁺ , Na ⁺ , Ca ²⁺	500 mg/L
CO ₃ ²⁻ , NO ₃ ⁻ , Fe ³⁺ , Cr ³⁺ , Cr ⁶⁺ , Zn ²⁺ , Cu ²⁺ , Co ²⁺ , Ni ²⁺ , Hg ²⁺	50 mg/L
Fe ²⁺	25 mg/L
Sn ²⁺	10 mg/L
Pb ²⁺	5 mg/L
Ag ⁺	2 mg/L

Sample Collection, Storage, and Preservation

Collect samples in clean plastic or glass bottles. Best results are obtained with immediate analysis. Preserve the samples by reducing the pH to 2 or less with at least 2 mL of Hydrochloric Acid. Store at 4 °C (39 °F) or less. Preserved samples may be stored up to 28 days. Before analysis, warm samples to 20–23 °C (68–73.4 °F) and neutralize to pH 7.0 with 5.0 N Sodium Hydroxide. Correct the test result for volume additions.

Accuracy Check

Standard Solution Method

Check the accuracy of the method with a 10 mg/L ammonia nitrogen standard. Use 0.5 mL of this 10 mg/L standard in place of the sample in step 2.

Summary of Method

Ammonium ions react at pH 12.6 with hypochlorite ions and salicylate ions in the presence of sodium nitroprusside as a catalyst to form indophenol. The amount of color formed is directly proportional to the ammonia nitrogen present in the sample. Test results are measured at 690 nm.

Nitrogen, Ammonia LR (1 to 12 mg/L NH₃-N)

Consumables and Replacement Items

Required Reagents

Description	Unit	Cat. No.
Ammonia, TNTplus ULR TNT831 Reagent Set	25 tests	TNT831

Required Apparatus

Description	Quantity/Test	Unit	Cat. No.
Light Shield	1	each	LZV646
Pipettor, variable volume, 100–1000 µL	1	each	27949-00
Pipettor Tips, for 27949-00 pipettor	1	400/pkg	27950-00

Recommended Standards and Apparatus

Description	Unit	Cat. No.
Nitrogen Ammonia Standard Solution, 10 mg/L NH ₃ -N	500 mL	153-49
Nitrogen Ammonia Standard Solution, 100 mg/L NH ₃ -N	500 mL,	24065-49
Wastewater, Effluent Inorganics Standard, for NH ₃ -N, NO ₃ -N, PO ₄ , COD, SO ₄ , TOC	500 mL	28332-49
Water, deionized	4L	272-56

Optional Reagents and Apparatus

Description	Cat. No.
Bottle, sampling, low density poly, w/cap, 500 mL, 12/pkg	20870-79
Distillation Set, general purpose	22653-00
Filter Holder, glass for vacuum filtration (SUVA)	2340-00
Filter membrane, 47-mm, 0.45-micron, hydrophilic, polyethersulfone for SUVA	28947-00
Flask, filtering, glass, 1000-mL (SUVA)	546-53
Hydrochloric Acid Standard Solution, 1 N	23213-53
Hydrochloric Acid, concentrated ACS	134-49
Sodium Hydroxide Standard Solution, 1 N	1045-32
Test Tube Rack for 13-mm vial	24979-00
Tubing, rubber, 12-ft	560-19



FOR TECHNICAL ASSISTANCE, PRICE INFORMATION AND ORDERING:
In the U.S.A. – Call toll-free 800-227-4224
Outside the U.S.A. – Contact the HACH office or distributor serving you.
On the Worldwide Web – www.hach.com; E-mail – techhelp@hach.com

HACH COMPANY
WORLD HEADQUARTERS
Telephone: (970) 669-3050
FAX: (970) 669-2932

Nitrogen, Ammonia

Method 10205

Salicylate Method

TNTplus™ 832

HR (2 to 47 mg/L NH₃-N)

Scope and Application: For surface waters, municipal and industrial wastewaters.



Test Preparation

Before starting the test:

Important Note: Install the light shield in Cell Compartment #2 before performing this test.

Please read Safety Advice and Expiration Date on package.

Recommended sample pH is 4–8.

Recommended sample and reagent temperature is 20–23 °C (68–73.4 °F). Incorrect results may be obtained if test is not performed at the recommended temperature.

Recommended reagent storage is 2–8 °C (35.6–46.4 °F).

Analyze samples as soon as possible for best results.

TNTplus methods are activated from the Main Menu screen when the sample vial is inserted into the sample cell holder.

Collect the following items:

Quantity

Ammonia, HR TNT832 Reagent Set	1 vial
Light Shield	1
Pipettor for 0.2 mL sample	1
Pipettor Tip	varies

Note: Reorder information for consumables and replacement items is on page 4.

TNTplus

Method 10205

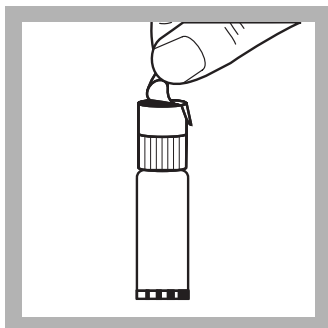

1. Carefully remove the protective foil lid from the DosiCap™ **Zip**. Unscrew the cap from the vial.

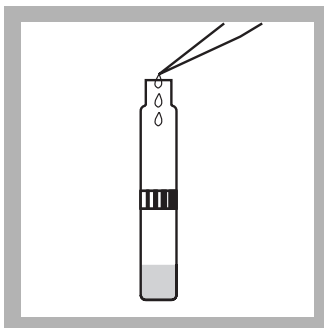

2. Carefully pipet 0.2 mL (200 µL) of sample into the vial. Immediately proceed to step 3.

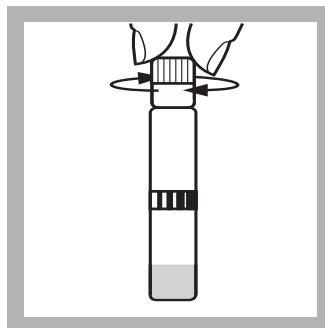

3. Flip the DosiCap **Zip** over so that the reagent side faces the vial. Screw the cap tightly onto the vial.

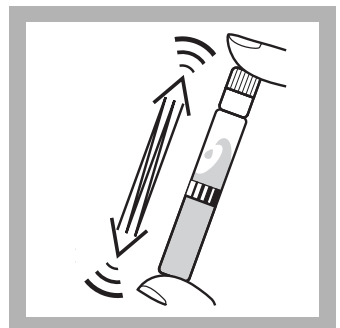

4. Shake the capped vial 2–3 times to dissolve the reagent in the cap.

Verify that the reagent has dissolved by looking down through the open end of the DosiCap **Zip**.



5. Wait 15 minutes.

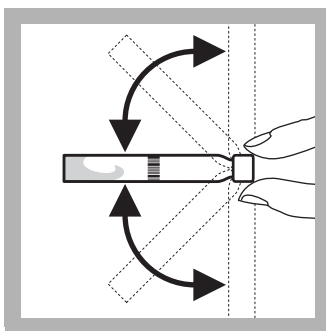

6. After 15 minutes, invert the sample an additional 2–3 times to mix.

The color remains constant for an additional 15 minutes after the timer expires.

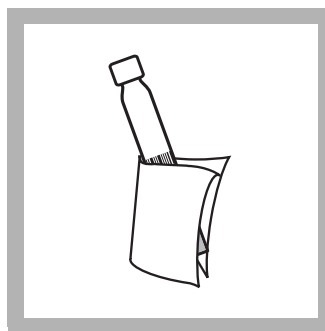

7. Thoroughly clean the outside of the vial.

Install the Light Shield in Cell Compartment #2.

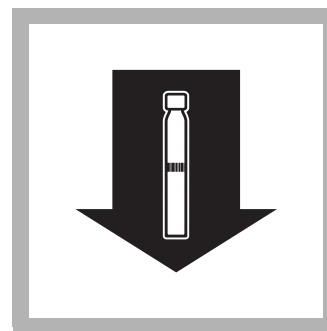

8. Insert the prepared vial into the cell holder.

The instrument reads the barcode, then selects and performs the correct test. Results are in mg/L NH₃-N.

No instrument Zero is required.

Reagent Blanks

A reagent blank can be measured, and the value subtracted from the results of each test performed using the same reagent lot number. Use deionized water in place of sample and run the procedure as described.

To subtract the value of the blank from a series of measurements, measure the blank per step 8. Press **OPTIONS>MORE>REAGENT BLANK**. Press **ON**. The measured value of the blank should be displayed in the highlighted box. Press **OK** to accept this value. The reagent blank value will now be subtracted from all results until the function is turned off, or a different method is selected. Alternately, the blank can be recorded and entered at any later time by pressing the highlighted box and using the keypad to enter the value.

Sample Blanks

Colored or turbid samples can cause high results. To compensate for color or turbidity the procedure is repeated and the color forming reagent that is present in the DosiCap **Zip** is not added.

To determine the sample blank run the procedure as given, but do not remove the foil from the DosiCap **Zip** in step 1 and replace the cap in its original position in step 3. The value obtained in step 8 is then subtracted from the value obtained on the original sample to give the corrected sample concentration.

Alternatively, samples that contain turbidity only may be first filtered through a membrane filter and then analyzed.

Interferences

The ions listed in [Table 1](#) have been individually checked up to the given concentrations and do not cause interference. Cumulative effects and the influence of other ions have not been determined.

Primary amines are determined and cause high-bias results. A 10000-fold excess of urea does not interfere. All reducing agents interfere and cause low-bias results.

Important Note: An analyte concentration greatly in excess of the stated range will adversely affect color formation, resulting in a false reading within the method range.

Measurement results can be verified using sample dilutions or standard additions.

Samples with severe interferences require distillation. The manufacturer recommends the distillation procedure using the Hach General Purpose Distillation Set.

Table 1 Interfering Substances and Levels

Interfering Substance	Interference Levels
Cl ⁻ , SO ₄ ²⁻	1000 mg/L
K ⁺ , Na ⁺ , Ca ²⁺	500 mg/L
CO ₃ ²⁻ , NO ₃ ⁻ , Fe ³⁺ , Cr ³⁺ , Cr ⁶⁺ , Zn ²⁺ , Cu ²⁺ , Co ²⁺ , Ni ²⁺ , Hg ²⁺	50 mg/L
Fe ²⁺	25 mg/L
Sn ²⁺	10 mg/L
Pb ²⁺	5 mg/L
Ag ⁺	2 mg/L

Sample Collection, Storage, and Preservation

Collect samples in clean plastic or glass bottles. Best results are obtained with immediate analysis. Preserve the samples by reducing the pH to 2 or less with at least 2 mL of Hydrochloric Acid. Store at 4 °C (39 °F) or less. Preserved samples may be stored up to 28 days. Before analysis, warm samples to 20–23 °C (68–73.4 °F) and neutralize to pH 7.0 with 5.0 N Sodium Hydroxide. Correct the test result for volume additions.

Accuracy Check

Standard Solution Method

1. Check the accuracy of the method with a 10 mg/L ammonia nitrogen standard. Use 0.2 mL of this 10 mg/L standard in place of the sample in step 2.
2. Alternately, use 0.2 mL of a Wastewater Influent Mixed Parameters Inorganics Standard in place of the sample in step 2. This standard contains 15 mg/L ammonia nitrogen in the presence of other ions such as nitrate, phosphate and sulfate.

Summary of Method

Ammonium ions react at pH 12.6 with hypochlorite ions and salicylate ions in the presence of sodium nitroprusside as a catalyst to form indophenol. The amount of color formed is directly proportional to the ammonia nitrogen present in the sample. Test results are measured at 690 nm.

Consumables and Replacement Items

Required Reagents

Description	Unit	Cat. No.
Ammonia, ULR TNT832 Reagent Set	25 tests	TNT832

Required Apparatus

Description	Quantity/Test	Unit	Cat. No.
Light Shield	1	each	LZV646
Pipettor, variable volume, 100–1000 µL	1	each	27949-00
Pipettor Tips, for 27949-00 pipettor	1	400/pkg	27950-00

Recommended Standards and Apparatus

Description	Unit	Cat. No.
Nitrogen Ammonia Standard Solution, 10 mg/L NH ₃ -N	500 mL	153-49
Nitrogen Ammonia Standard Solution, 100 mg/L NH ₃ -N	500 mL,	24065-49
Wastewater, Influent Inorganics Standard, for NH ₃ -N, NO ₃ -N, PO ₄ , COD, SO ₄ , TOC	500 mL	28331-49
Water, deionized	4L	272-56

Optional Reagents and Apparatus

Description	Cat. No.
Bottle, sampling, low density poly, w/cap, 500 mL, 12/pkg	20870-79
Distillation Set, general purpose	22653-00
Filter Holder, glass for vacuum filtration (SUVA)	2340-00
Filter membrane, 47-mm, 0.45-micron, hydrophilic, polyethersulfone for SUVA	28947-00
Flask, filtering, glass, 1000-mL (SUVA)	546-53
Hydrochloric Acid Standard Solution, 1 N	23213-53
Hydrochloric Acid, concentrated ACS	134-49
Sodium Hydroxide Standard Solution, 1 N	1045-32
Test Tube Rack for 13-mm vial	24979-00
Tubing, rubber, 12-ft	560-19



FOR TECHNICAL ASSISTANCE, PRICE INFORMATION AND ORDERING:
 In the U.S.A. – Call toll-free 800-227-4224
 Outside the U.S.A. – Contact the HACH office or distributor serving you.
 On the Worldwide Web – www.hach.com; E-mail – techhelp@hach.com

HACH COMPANY
 WORLD HEADQUARTERS
 Telephone: (970) 669-3050
 FAX: (970) 669-2932

Nitrogen, Free Ammonia

Method 10201

Indophenol Method¹

Powder Pillows

(0.01 to 0.50 mg/L NH₃-N)

Scope and Application: For controlling free ammonia levels during the production of chloramines, at booster stations and for monitoring free ammonia levels in potable distribution system waters.

¹ U.S. Patent 6,315,950



Test Preparation

Before starting the test:

Use Method 10200, Nitrogen, Free Ammonia and Chloramine (Mono) to determine free ammonia and monochloramine simultaneously on the same sample.

In bright light conditions (e.g. direct sunlight) it may be necessary to close the cell compartment with the protective cover during measurements.

Collect the following items:

Quantity

Free Ammonia Reagent Set	—
Free Ammonia Reagent Solution	1 drop
Monochlor F Reagent Pillows	2
Sample Cell, 1-cm, 10-mL	2

Note: Reorder information for consumables and replacement items is on page 6.

Multi-path Cell

Method 10201

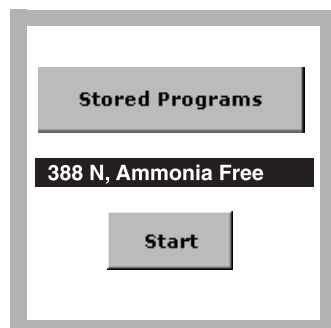

1. Select the Free Ammonia test.

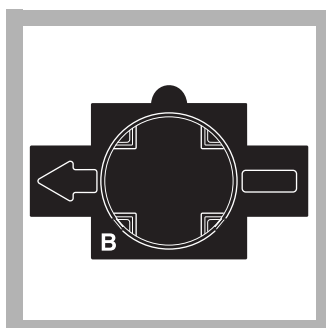

2. Insert Adapter B.

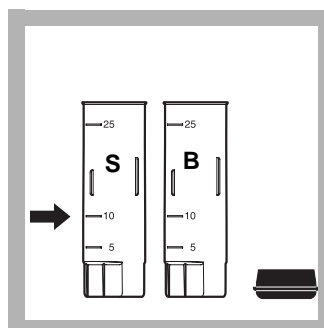

3. Fill two 1-cm cells to the 10-mL line with sample.

Label one cell 'sample' and one cell 'blank'.

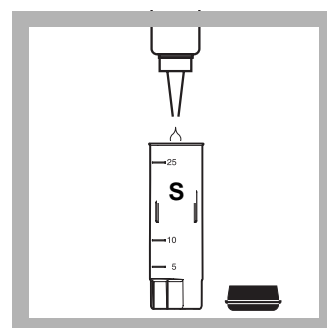

4. **Prepared Sample:** Add one drop of Free Ammonia Reagent Solution to the sample.



5. Cap the reagent bottle to maintain reagent performance and stability.

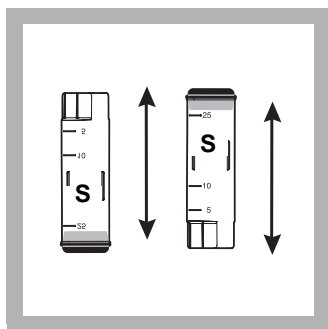

6. Cap and invert the sample to mix. If the sample becomes cloudy by the end of the reaction period, pretreat the sample and retest. See [Interferences on page 3](#).

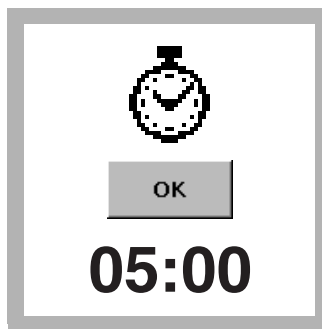

7. Press **TIMER>OK**. A 5-minute reaction period will begin. Color development time depends on sample temperature. For accurate results allow the full reaction period to occur. See [Table 2 on page 4](#).

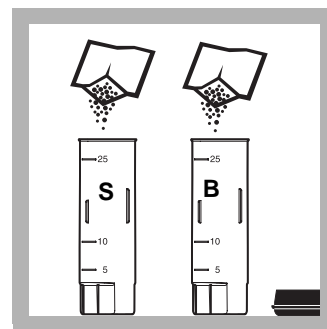

8. When the timer expires, add the contents of one MonoChlor F powder pillow to each cell.

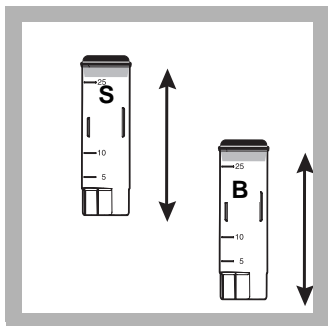

9. Cap and shake both cells about 20 seconds to dissolve the reagent. A green color will develop if monochloramine is present.



10. Press **TIMER>OK**. A 5-minute reaction period will begin. Color development time depends on sample temperature. For accurate results allow the full reaction period to occur. See [Table 2 on page 4](#).

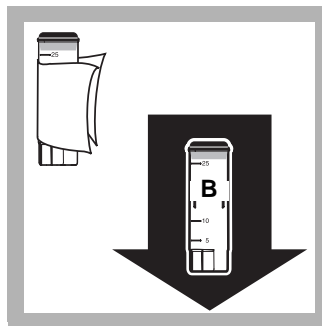

11. When the timer expires, insert the vial into the cell holder with the 1-cm (flat) path in line with the indicator arrow on the adapter.

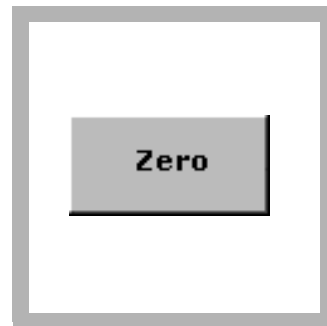

12. Press **ZERO**. The display will show: 0.00 mg/L NH₃-N f Remove the blank.

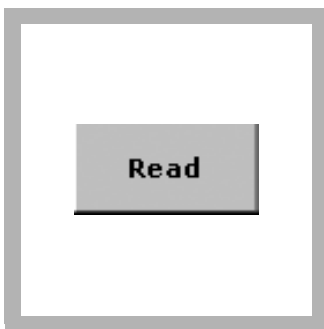
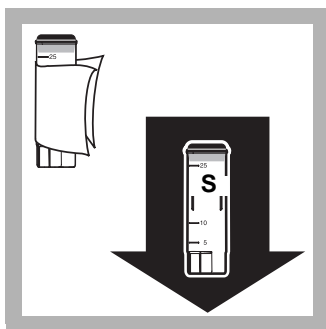

13. Insert the sample into the cell holder with the 1-cm (flat) path in line with the indicator arrow on the adapter.

14. Press **READ**.
Results are in mg/L NH₃-N f.

Interferences

This method is intended for finished, chloraminated drinking water samples that have a measurable combined (total) chlorine disinfectant residual. Samples where the disinfectant residual has disappeared and samples which exhibit a chlorine demand may produce low ammonia test results. Blanks and ammonia standards analyzed without a disinfectant residual must be prepared using high quality, reagent grade water.

The following do not interfere in free ammonia determination at or below the stated concentration:

Table 1 Non-interfering Substances

Substance	Maximum Level Tested
Aluminum	0.2 mg/L
Chloride	1200 mg/L Cl
Copper	1 mg/L Cu
Iron	0.3 mg/L Fe
Manganese	0.05 mg/L Mn
Nitrate	10 mg/L NO ₃ -N
Nitrite	1 mg/L NO ₂ -N
Phosphate	2 mg/L o-PO ₄
Silica	100 mg/L SiO ₂
Sulfate	1600 ppm as CaCO ₃
Zinc	5 ppm Zn

Samples containing high levels of both Total Hardness and Alkalinity may become cloudy after the addition of the Free Ammonia Reagent Solution. If this occurs by the end of the first reaction period, the sample for Free Ammonia measurement must be pretreated as follows:

Note: The blank does not need pretreatment.

1. Measure 10 mL of sample into the cell for the labeled sample.
2. Add the contents of one Hardness Treatment Reagent Powder Pillow to the sample.

3. Cap the cell and invert until the reagent is dissolved.
4. Remove the cap.
5. Continue with the analysis at step 3 using the pretreated sample as the sample cell.

Color Development Time

Test results are strongly influenced by sample temperature. **Both reaction periods in the procedure are the same and depend on the temperature of the sample.** The reaction periods indicated in the procedure are for a sample temperature of 18–20 °C (64–68 °F). Adjust both reaction periods according to [Table 2](#).

Table 2 Color Development Based on Sample Temperature

Sample Temperature		Development Time (minutes)
°C	°F	
5	41	10
7	45	9
9	47	8
10	50	8
12	54	7
14	57	7
16	61	6
18	64	5
20	68	5
23	73	2.5
25	77	2
greater than 25	greater than 77	2

Sampling and Storage

Collect samples in clean glass bottles. Most reliable results are obtained when samples are analyzed as soon as possible after collection.

Accuracy Check

Dilution water is required when testing a diluted sample and preparing standard solutions. Dilution water must be free of ammonia, chlorine and chlorine demand. A convenient source is a recirculating, deionizer system with carbon filtration which produces 18 megaohm-cm water.

Standard Additions Method

1. After reading test results, leave the sample cell (unspiked sample) in the instrument. Verify the chemical form.
2. Press **OPTIONS>MORE**. Press **STANDARD ADDITIONS**. A summary of the standard additions procedure will appear.

3. Press **OK** to accept the default values for standard concentrations, sample volume, and spike volumes. Press **EDIT** to change these values. After values are accepted, the unspiked sample reading will appear in the top row. See the user manual for more information.
4. Prepare three spiked samples. Measure 50 mL of sample into three 50-mL mixing cylinders.
5. Use the TenSette® Pipet to add 0.3, 0.6, and 1.0 mL of Ammonium Nitrogen Standard, 10 mg/L as NH₃-N to the three samples. Mix well.
6. Analyze each spiked sample starting with the 0.3 mL sample spike. Accept each standard additions reading by pressing **READ**. Each addition should reflect approximately 100% recovery. Follow all steps in Method 10201.
7. After completing the sequence, press **GRAPH** to view the best-fit line through the standard additions data points, accounting for matrix interferences. Press **IDEAL LINE** to view the relationship between the sample spikes and the "Ideal Line" of 100% recovery.

Standard Solution Method

1. Prepare a 0.20 mg/L ammonia nitrogen standard by diluting 2.00 mL of the Ammonia Nitrogen Standard Solution, 10 mg/L, to 100 mL with dilution water. Or, using the TenSette Pipet, prepare a 0.20 mg/L ammonia nitrogen standard by diluting 0.4 mL of a Ammonia Nitrogen Voluette Standard Solution, 50 mg/L as NH₃-N, to 100 mL with dilution water. Analyze the Standard Solution, following all steps in Method 10201.
2. To adjust the calibration curve using the reading obtained with the standard solution, press **OPTIONS>MORE** on the current program menu. Press **STANDARD ADJUST**.
3. Press **ON**. Press **ADJUST** to accept the displayed concentration. If an alternate concentration is used, press the number in the box to enter the actual concentration, then press **OK**. Press **ADJUST**.

Summary of Method

Monochloramine (NH₂Cl) and free ammonia (NH₃ and NH₄⁺) can exist in the same water sample. Added hypochlorite combines with free ammonia to form more monochloramine. In the presence of a cyanoferrate catalyst, monochloramine in the sample reacts with a substituted phenol to form an intermediate monoimine compound. The intermediate couples with excess substituted phenol to form a green-colored indophenol, which is proportional to the amount of monochloramine present in the sample. Free ammonia is determined by comparing the color intensities, with and without added hypochlorite. Test results are measured at 655 nm.

Nitrogen, Free Ammonia (0.01 to 0.50 mg/L NH₃-N)

Consumables and Replacement Items

Required Reagents

Description	Quantity/Test	Unit	Cat. No.
Free Ammonia Reagent Set (50 tests), includes: (1) 28022-99, (1) 28773-36	—	—	28797-00
Free Ammonia Reagent Solution	1 drop	4 mL SCDB	28773-36
Monochlor F Reagent Pillows	2	100/pkg	28022-99

Required Apparatus

Description	Quantity/Test	Unit	Cat. No.
Adapter, for Multi-path and Pour-Thru cells	1	each	LZV585
Sample cell, multi-path	2	2/pkg	59405-06

Recommended Standards and Reagents

Description	Unit	Cat. No.
Hardness Treatment Reagent Pillows (1 per test)	50/pkg	28823-46
Nitrogen Ammonia Standard Solution, 10 mg/L as NH ₃ -N	500 mL	153-49
Nitrogen Ammonia Standard Ampule, 50 mg/L as NH ₃ -N, 10 mL	16/pkg	14791-10
Water, organic-free water	500-mL	26415-49

Recommended Apparatus

Description	Unit	Cat. No.
Ampule Breaker Kit	each	21968-00
Flask, volumetric, Class A, 100 mL	each	14574-42
Pipet Filler, Safety Bulb	each	14651-00
Pipet, TenSette®, 0.1 to 1.0 mL	each	19700-01
Pipet Tips, for TenSette Pipet 19700-01	50/pkg	21856-96
Thermometer, -10 to 110 °C	each	1877-01
Wipers, Disposable Kimwipes®, 30 x 30 cm, 280/box	box	20970-00



FOR TECHNICAL ASSISTANCE, PRICE INFORMATION AND ORDERING:
In the U.S.A. – Call toll-free 800-227-4224
Outside the U.S.A. – Contact the HACH office or distributor serving you.
On the Worldwide Web – www.hach.com; E-mail – techhelp@hach.com

HACH COMPANY
WORLD HEADQUARTERS
Telephone: (970) 669-3050
FAX: (970) 669-2932

Nitrogen, Total

Method 10072

Persulfate Digestion Method

Test 'N Tube™ Vials

HR (2 to 150 mg/L N)

Scope and Application: For water and wastewater



Test Preparation

Before starting the test:

Important Note: Install the light shield in Cell Compartment #2 before performing this test.

Digestion is required for determining total nitrogen.

This test is technique-sensitive. Invert the vials as described here to avoid low results: Hold the vial in a vertical position with the cap pointing up. Turn the vial upside-down. Wait for all of the solution to flow down to the cap. Pause. Return the vial to an upright position. Wait for all the solution to flow to the bottom of the vial. This process equals one inversion.

If the test overranges, repeat the digestion and measurement with diluted sample. The digestion must be repeated for accurate results.

Use the deionized water provided in the reagent set or Organic-free Water to prepare the standards and perform the procedure.

Collect the following items:

Quantity

Test 'N Tube™ HR Total Nitrogen Reagent Set	1
DRB200 Reactor	1
Funnel, micro	1
Light Shield	1
Pipet, TenSette®, 0.1 to 1.0 mL plus tips	1
Pipet, TenSette®, 1.0 to 10.0 mL plus tips	1
Test Tube Cooling Rack	1–3

Note: Reorder information for consumables and replacement items is on page 7.

Test 'N Tube

Method 10072

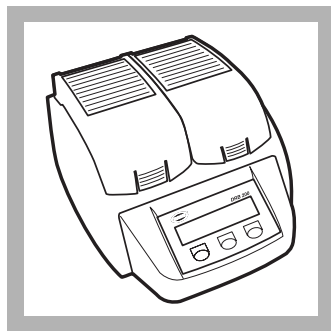

1. Turn on the DRB200 Reactor and heat to 105 °C.

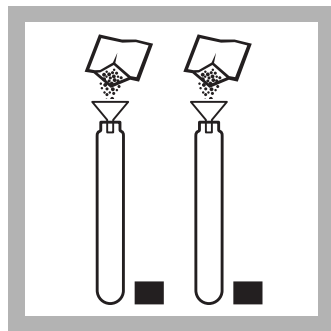

2. Using a funnel, add the contents of one Total Nitrogen Persulfate Reagent Powder Pillow to each of two HR Total Nitrogen Hydroxide Digestion Reagent vials. Wipe off any reagent that may get on the lid or the tube threads.

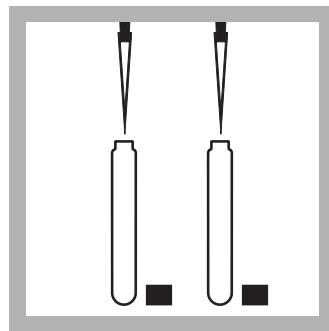

3. Add 0.5 mL of sample to a vial (this is the prepared sample). Add 0.5 mL of the deionized water to a second vial (this is the reagent blank). Use only water that is free of all nitrogen-containing species as a substitute for the deionized water provided.

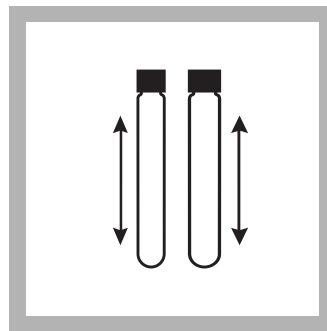

4. Cap both vials. Shake vigorously for at least 30 seconds to mix. The persulfate reagent may not dissolve completely after shaking. This will not affect accuracy.



5. Insert the vials in the reactor. Heat for exactly 30 minutes.

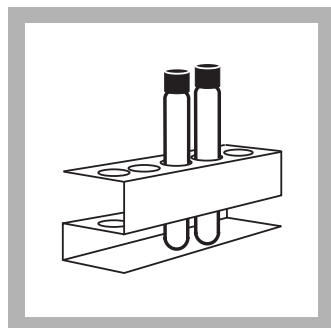

6. Using finger cots, immediately remove the hot vials from the reactor. Cool the vials to room temperature.

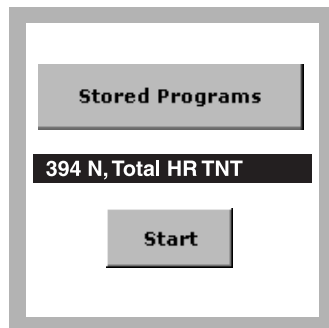

7. Select the test. Install the Light Shield in Cell Compartment #2.

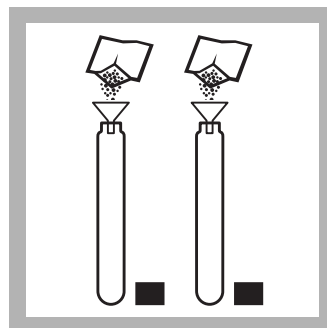

8. Remove the caps from the digested vials and add the contents of one Total Nitrogen (TN) Reagent A Powder Pillow to each vial.

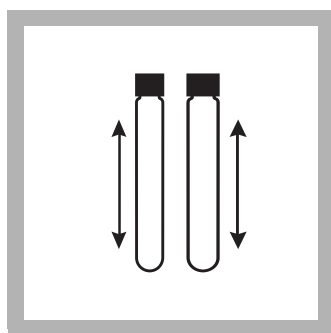

9. Cap the tubes and shake for 15 seconds.

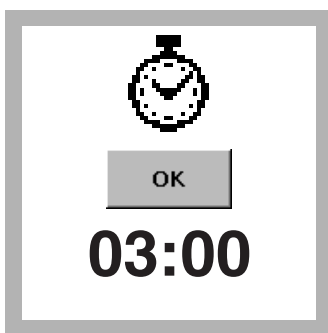

10. Press **TIMER>OK**.
A three-minute reaction period will begin.

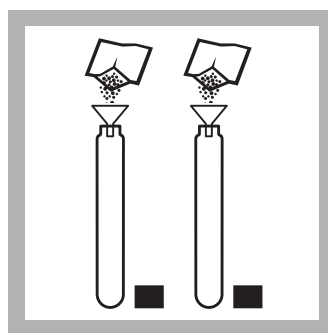

11. After the timer expires, remove the caps from the vials and add one TN Reagent B Powder Pillow to each vial.

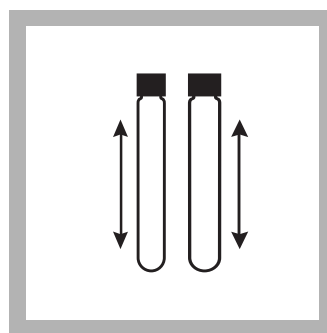

12. Cap the tubes and shake for 15 seconds. The reagent will not completely dissolve. This will not affect accuracy. The solution will begin to turn yellow.

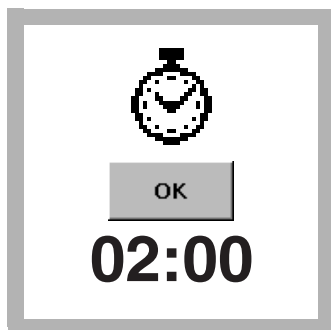

13. Press **TIMER>OK**.
A two-minute reaction period will begin.

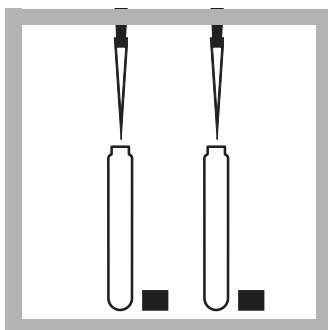

14. After the timer expires, remove the caps from two TN Reagent C vials and add 2 mL of digested, treated sample to one vial. Add 2 mL of digested, treated reagent blank to the second TN Reagent C vial.

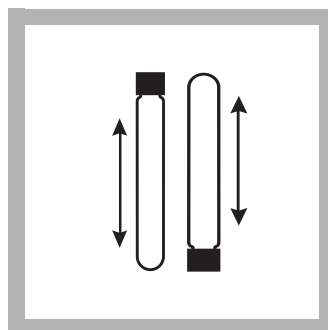

15. Cap the vials and invert ten times to mix. Use slow, deliberate inversions for complete recovery.
The tubes will be warm to the touch.

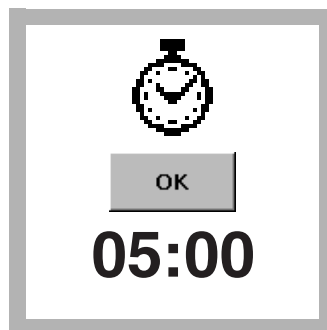

16. Press **TIMER>OK**.
A five-minute reaction period will begin.
The yellow color will intensify.



17. Wipe the reagent blank and insert it into the 16-mm round cell holder.

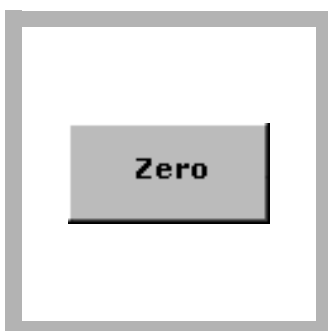

18. Press **ZERO**.
The display will show:
0.0 mg/L N

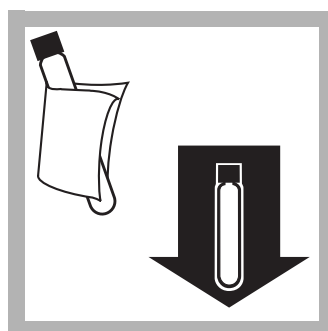

19. Wipe the reagent vial and insert it into the 16-mm round cell holder.

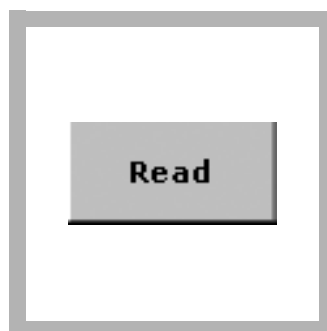

20. Press **READ**.
Results are in mg/L N.

Blanks for Colorimetric Measurement

The reagent blank may be used up to seven days for measurements using the same lots of reagents. Store it in the dark at room temperature (18–25 °C). If a small amount of white floc appears prior to the end of one week, discard the reagent blank and prepare a new one.

Interferences

The substances in [Table 1](#) have been tested and found not to interfere up to the indicated levels (in mg/L). Interfering substances that resulted in a concentration change of $\pm 10\%$ appear in [Table 2](#).

Table 1 Non-interfering Substances

Substance	Maximum Level Tested
Barium	10.4 mg/L
Calcium	1200 mg/L
Chromium (3+)	2 mg/L
Iron	8 mg/L
Lead	26.4 µg/L
Magnesium	2000 mg/L
Organic Carbon	600 mg/L
pH	13 pH units
Phosphorus	400 mg/L
Silica	600 mg/L
Silver	3.6 mg/L
Tin	6 mg/L

Table 2 Interfering Substances

Substance	Level and Effect
Bromide	> 240 mg/L; positive interference
Chloride	> 3000 mg/L; positive interference

This test performed with standard nitrogen solutions prepared from the following compounds obtained 95% recovery:

- Ammonium chloride
- Ammonium sulfate
- Ammonium acetate
- Urea
- Glycine

Ammonium chloride or nicotinic-PTSA spikes in domestic influent, effluent and the ASTM standard specification for substitute wastewater (D 5905-96) also resulted in $\geq 95\%$ recovery.

The large amounts of nitrogen-free organic compounds in some samples may decrease digestion efficiency by consuming some of the persulfate reagent. Samples known to contain high levels of organics should be diluted and re-run to verify digestion efficiency.

Sample Collection, Storage, and Preservation

Collect samples in clean plastic or glass bottles. Best results are obtained with immediate analysis.

Preserve the sample by reducing the pH to 2 or less with concentrated (at least 2 mL/L) Sulfuric Acid. Store at 4 °C (39 °F) or less. Preserved samples may be stored up to 28 days. Warm samples to room temperature and neutralize with 5 N Sodium Hydroxide before analysis. Correct the test result for volume additions.

Accuracy Check

This method generally yields 95–100% recovery on organic nitrogen standards. A set of three Kjeldahl Nitrogen Primary Standards is available for proof of accuracy.

1. Prepare one or more of the following three solutions. Each preparation is for an equivalent 120-mg/L N standard. Use the deionized water included in the kit or water that is free of all organic and nitrogen-containing species.
 - a. Weigh 1.6208 g of Ammonium p-Toluenesulfonate (PTSA). Dissolve in a 1000-mL volumetric flask with deionized water. Add deionized water to the 1000-mL mark.
 - b. Weigh 2.1179 g of Glycine p-Toluenesulfonate (PTSA). Dissolve in a 1000-mL volumetric flask with deionized water. Add deionized water to the 1000-mL mark.
 - c. Weigh 2.5295 g of Nicotinic p-Toluenesulfonate (PTSA). Dissolve in a 1000-mL volumetric flask with deionized water. Add deionized water to the 1000-mL mark.
2. Analyze each of these solutions using the test procedure above. Calculate the percent recovery for each using this formula:

$$\% \text{ recovery} = \frac{\text{measured concentration}}{25(120)} \times 100$$

The percent recovery should be:

Table 3 % Recovery

Compound	Lowest Expected % Recovery
Ammonia-PTSA	95%
Glycine-PTSA	95%
Nicotinic-PTSA	95%

Analysts have found Ammonia-PTSA to be the most difficult to digest. Other compounds may yield different percent recoveries.

Standard Additions Method (Sample Spike)

1. After reading test results, leave the sample cell (unspiked sample) in the instrument. Verify the chemical form.
2. Press **OPTIONS>MORE**. Press **STANDARD ADDITIONS**. A summary of the standard additions procedure will appear.

3. Press **OK** to accept the default values for standard concentration, sample volume, and spike volumes. Press **EDIT** to change these values. After values are accepted, the unspiked sample reading will appear in the top row. See the user manual for more information.
4. Prepare three sample spikes. Fill three Mixing Cylinders with 25 mL of sample. Use the TenSette® Pipet to add 0.1 mL, 0.2 mL, and 0.3 mL of an Ammonia Nitrogen Standard Solution, 1000-mg/L as NH₃-N, respectively, to each sample and mix thoroughly.
5. Analyze each sample spike as described in the procedure above, starting with the 0.1 mL sample spike. Accept each standard additions reading by pressing **READ**. Each addition should reflect approximately 100% recovery.
6. After completing the sequence, press **GRAPH** to view the best-fit line through the standard additions data points, accounting for matrix interferences. Press **IDEAL LINE** to view the relationship between the sample spikes and the "Ideal Line" of 100% recovery.

Standard Solution Method

1. For proof of accuracy, substitute 0.5 mL of a 100-mg/L ammonia nitrogen standard solution for the sample in the procedure.
2. To adjust the calibration curve using the reading obtained with a 100-mg/L N standard solution, press **OPTIONS>MORE** on the current program menu. Press **STANDARD ADJUST**.
3. Press **ON**. Press **ADJUST** to accept the displayed concentration (the value depends on the selected chemical form). If an alternate concentration is used, press the number in the box to enter the actual concentration. Press **OK**. Press **ADJUST**.

Summary of Method

An alkaline persulfate digestion converts all forms of nitrogen to nitrate. Sodium metabisulfite is added after the digestion to eliminate halogen oxide interferences. Nitrate then reacts with chromotropic acid under strongly acidic conditions to form a yellow complex with an absorbance maximum at 410 nm.

Consumables and Replacement Items

Required Reagents

Description	Unit	Cat. No.
Test 'N Tube™ Total HR Nitrogen Reagent Set	50 vials	27141-00

Required Apparatus

Description	Quantity/Test	Unit	Cat. No.
DRB200 Reactor, 110 V, 15 x 16 mm	1	each	LTV082.53.40001
DRB200 Reactor, 220 V, 15 x 16 mm	1	each	LTV082.52.40001
Funnel, micro	1	each	25843-35
Light Shield	1	each	LZV646
Pipet, TenSette®, 0.1 to 1.0 mL	1	each	19700-01
Pipet Tips, for TenSette Pipet 19700-01	2	50/pkg	21856-96
Pipet, TenSette, 1.0 to 10.0 mL	1	each	19700-10
Pipet Tips, for TenSette Pipet 19700-10	2	50/pkg	21997-96
Test Tube Cooling Rack	1–3	each	18641-00

Recommended Standards and Apparatus

Description	Unit	Cat. No.
Ammonia Nitrogen Standard Sol., 1000-mg/L NH ₃ -N	1 L	23541-53
Ammonia Nitrogen Standard Sol., 100-mg/L NH ₃ -N	500 mL	24065-49
Balance, analytical SA80, 115 VAC	each	28014-01
Cylinder, mixing with stopper, 25 mL	each	20886-40
Flask, volumetric, Class A, 1000 mL	each	14574-53
Pipet tips for 19700-01	1000/pkg	21856-28
Pipet tips for 19700-10	250-pkg	21997-25
Primary Standard Set, for Kjeldahl Nitrogen	set of 3	22778-00
Sodium Hydroxide, 5 N	50 mL	2450-26
Sulfuric Acid	500 mL	979-49
Wastewater Mixed Inorganic Standard for NH ₃ -H, NO ₃ -N, PO ₄ , COD, SO ₄ , TOC	500 mL	28331-49
Water, deionized	500 mL	272-49
Water, organic-free	500 mL	26415-49



FOR TECHNICAL ASSISTANCE, PRICE INFORMATION AND ORDERING:

In the U.S.A. – Call toll-free 800-227-4224
Outside the U.S.A. – Contact the HACH office or distributor serving you.
On the Worldwide Web – www.hach.com; E-mail – techhelp@hach.com

HACH COMPANY
WORLD HEADQUARTERS
Telephone: (970) 669-3050
FAX: (970) 669-2932

Nitrogen, Total

Method 10071

Persulfate Digestion Method

Test 'N Tube™ Vials

LR (0.5 to 25.0 mg/L N)

Scope and Application: For water and wastewater.



Test Preparation

Before starting the test:

Important Note: Install the light shield in Cell Compartment #2 before performing this test.

Digestion is required for determining total nitrogen.

This test is technique-sensitive. Invert the vials as described here to avoid low results: Hold the vial in a vertical position with the cap pointing up. Turn the vial upside-down. Wait for all of the solution to flow down to the cap. Pause. Return the vial to an upright position. Wait for all the solution to flow to the bottom of the vial. This process equals one inversion.

If the test overranges, repeat the digestion and measurement with diluted sample. The digestion must be repeated for accurate results.

Use the deionized water provided in the reagent set or Organic-free Water to prepare the standards and perform the procedure.

Collect the following items:

Quantity

Test 'N Tube™ LR Total Nitrogen Reagent Set	1
DRB200 Reactor	1
Funnel, micro	1
Light Shield	1
Pipet, TenSette®, 1.0 to 10.0 mL plus tips	1
Test Tube Cooling Rack	1–3

Note: Reorder information for consumables and replacement items is on page 7.

Test 'N Tube

Method 10071

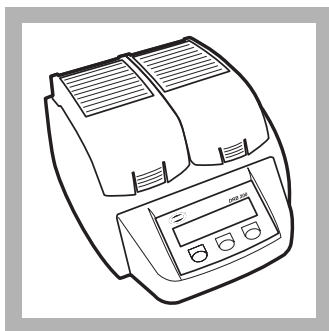

1. Turn on the DRB200 Reactor and heat to 105 °C.

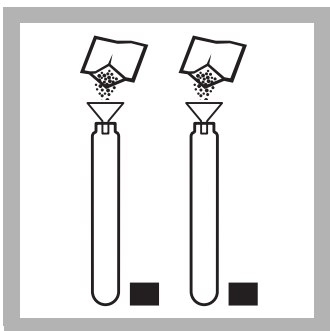

2. Using a funnel, add the contents of one Total Nitrogen Persulfate Reagent Powder Pillow to each of two Total Nitrogen Hydroxide Digestion Reagent vials. Wipe off any reagent that may get on the lid or the tube threads.

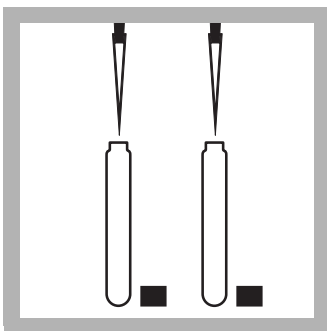

3. **Prepared Sample:** Add 2 mL of sample to one vial.

Blank Preparation: Add 2 mL of the deionized water included in the kit to a second vial.

Note: Use only water that is free of all nitrogen-containing species as a substitute for the provided deionized water.

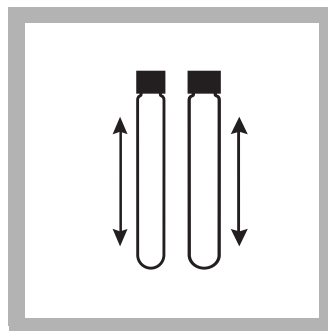

4. Cap both vials. Shake vigorously for at least 30 seconds to mix. The persulfate reagent may not dissolve completely after shaking. This will not affect accuracy.

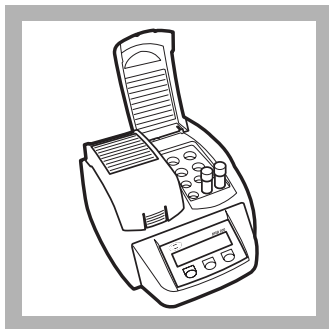

5. Insert the vials in the reactor. Heat for exactly 30 minutes.

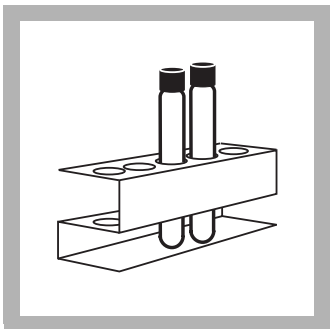

6. Using finger cots, immediately remove the hot vials from the reactor. Cool the vials to room temperature.

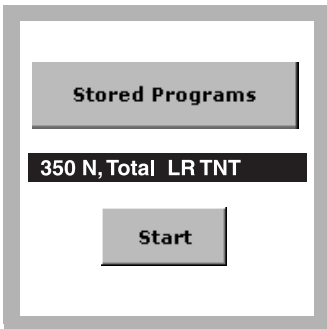

7. Select the test. Install the Light Shield in Cell Compartment #2.

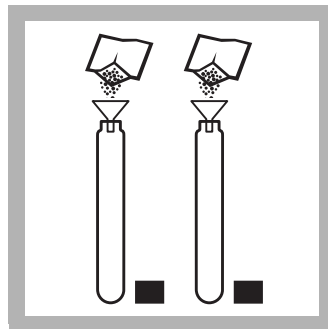

8. Remove the caps from the digested vials and add the contents of one Total Nitrogen (TN) Reagent A Powder Pillow to each vial.

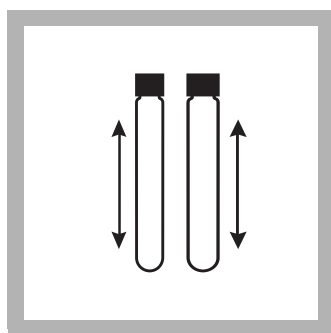

9. Cap the tubes and shake for 15 seconds.

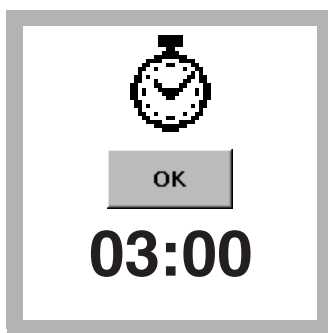

10. Press **TIMER>OK**.
A three-minute reaction period will begin.

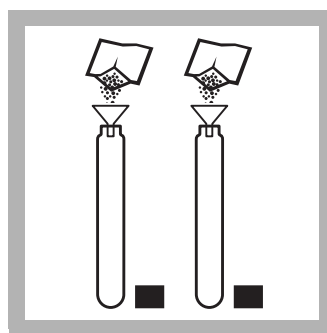

11. After the timer expires, remove the caps from the vials and add one TN Reagent B Powder Pillow to each vial.

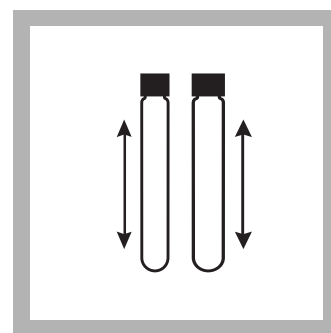

12. Cap the tubes and shake for 15 seconds. The reagent will not completely dissolve. This will not affect accuracy. The solution will begin to turn yellow.

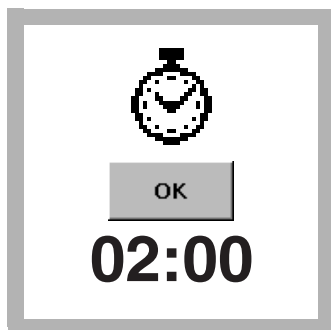

13. Press **TIMER>OK**.
A two-minute reaction period will begin.

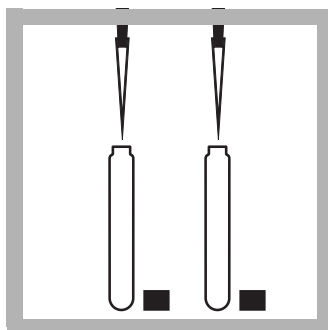

14. After the timer expires, remove the caps from two TN Reagent C vials and add 2 mL of digested, treated sample to one vial. Add 2 mL of digested, treated reagent blank to the second TN Reagent C vial.

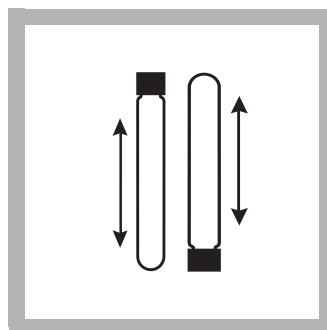

15. Cap the vials and invert ten times to mix. Use slow, deliberate inversions for complete recovery.
The tubes will be warm to the touch.

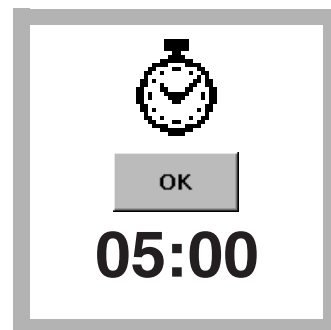

16. Press **TIMER>OK**.
A five-minute reaction period will begin.
The yellow color will intensify.



17. Wipe the reagent blank and insert it into the 16-mm round cell holder.

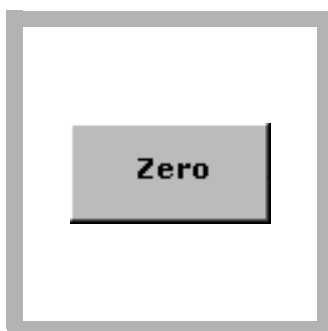

18. Press **ZERO**.
The display will show:
0.0 mg/L N

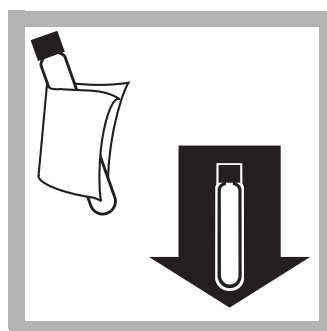

19. Wipe the reagent vial and insert it into the 16-mm round cell holder.

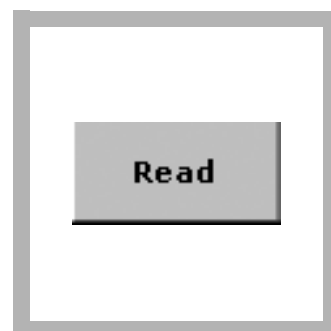

20. Press **READ**.
Results are in mg/L N.

Blanks for Colorimetric Measurement

The reagent blank may be used up to seven days for measurements using the same lots of reagents. Store it in the dark at room temperature (18–25 °C). If a small amount of white floc appears prior to the end of one week, discard the reagent blank and prepare a new one.

Interferences

The substances in [Table 1](#) have been tested and found not to interfere up to the indicated levels (in mg/L). Interfering substances that resulted in a concentration change of $\pm 10\%$ appear in [Table 2](#).

Table 1 Non-interfering Substances

Substance	Maximum Level Tested
Barium	2.6 mg/L
Calcium	300 mg/L
Chromium (3+)	0.5 mg/L
Iron	2 mg/L
Lead	6.6 µg/L
Magnesium	500 mg/L
Organic Carbon	150 mg/L
pH	13 pH units
Phosphorus	100 mg/L
Silica	150 mg/L
Silver	0.9 mg/L
Tin	1.5 mg/L

Table 2 Interfering Substances

Substance	Level and Effect
Bromide	> 60 mg/L; positive interference
Chloride	> 1000 mg/L; positive interference

This test performed with standard nitrogen solutions prepared from the following compounds obtained 95% recovery:

- Ammonium chloride
- Ammonium sulfate
- Ammonium acetate
- Urea
- Glycine

Ammonium chloride or nicotinic-PTSA spikes in domestic influent, effluent and the ASTM standard specification for substitute wastewater (D 5905-96) also resulted in $\geq 95\%$ recovery.

The large amounts of nitrogen-free organic compounds in some samples may decrease digestion efficiency by consuming some of the persulfate reagent. Samples known to contain high levels of organics should be diluted and re-run to verify digestion efficiency.

Sample Collection, Storage, and Preservation

Collect samples in clean plastic or glass bottles. Best results are obtained with immediate analysis.

Preserve the sample by reducing the pH to 2 or less with concentrated (at least 2 mL/L) Sulfuric Acid. Store at 4 °C (39 °F) or less. Preserved samples may be stored up to 28 days. Warm samples to room temperature and neutralize with 5 N Sodium Hydroxide before analysis. Correct the test result for volume additions.

Accuracy Check

This method generally yields 95–100% recovery on organic nitrogen standards. For proof of accuracy use Primary Standards for Kjeldahl Nitrogen.

1. Prepare one or more of the following three solutions. Each preparation is for an equivalent 25-mg/L N standard. Use the deionized water included in the kit or water that is free of all organic and nitrogen-containing species.
 - a. Weigh 0.3379 g of Ammonium p-Toluenesulfonate (PTSA). Dissolve in a 1000-mL volumetric flask with deionized water. Add deionized water to the 1000-mL mark.
 - b. Weigh 0.4416 g of Glycine p-Toluenesulfonate (PTSA). Dissolve in a 1000-mL volumetric flask with deionized water. Add deionized water to the 1000-mL mark.
 - c. Weigh 0.5274 g of Nicotinic p-Toluenesulfonate (PTSA). Dissolve in a 1000-mL volumetric flask with deionized water. Add deionized water to the 1000-mL mark.
2. Analyze each of these solutions using the test procedure above. Calculate the percent recovery for each using this formula:

$$\% \text{ recovery} = \frac{\text{measured concentration}}{25} \times 100$$

The percent recovery is listed in [Table 3](#)

Table 3 Percent Recovery

Compound	Lowest Expected % Recovery
Ammonia-PTSA	95%
Glycine-PTSA	95%
Nicotinic-PTSA	95%

Analysts have found Ammonia-PTSA to be the most difficult to digest. Other compounds may yield different percent recoveries.

Standard Additions Method (Sample Spike)

1. After reading test results, leave the sample cell (unspiked sample) in the instrument. Verify the chemical form.
2. Press **OPTIONS>MORE**. Press **STANDARD ADDITIONS**. A summary of the standard additions procedure will appear.

3. Press **OK** to accept the default values for standard concentration, sample volume, and spike volumes. Press **EDIT** to change these values. After values are accepted, the unspiked sample reading will appear in the top row. See the user manual for more information.
4. Open a fresh bottle of Ammonia Nitrogen Standard Solution, 1000-mg/L as $\text{NH}_3\text{-N}$.
5. Prepare three sample spikes. Fill three mixing cylinders with 50 mL of sample. Use the TenSette® Pipet to add 0.1, 0.2, and 0.3 mL of standard, respectively, to each sample and mix thoroughly.
6. Add 2 mL of each prepared solution, respectively, to three Total Nitrogen Hydroxide Reagent Vials.
7. Analyze each sample spike as described in the procedure above, starting with the 0.1 mL sample spike. Accept each standard additions reading by pressing **READ**. Each addition should reflect approximately 100% recovery.
8. After completing the sequence, press **GRAPH** to view the best-fit line through the standard additions data points, accounting for the matrix interferences. Press **IDEAL LINE** to view the relationship between the sample spikes and the "Ideal Line" of 100% recovery.

Standard Solution Method

1. For proof of accuracy, substitute 2 mL of a 10-mg/L ammonia nitrogen standard solution for the sample in the procedure. A single analyst should obtain less than 5% variation on replicates.
2. To adjust the calibration curve using the reading obtained with the standard solution, press **OPTIONS>MORE** on the current program menu. Press **STANDARD ADJUST**.
3. Press **ON**. Press **ADJUST** to accept the displayed concentration (the value depends on the selected chemical form). If an alternate concentration is used, press the number in the box to enter the actual concentration, then press **OK**. Press **ADJUST**.

Summary of Method

An alkaline persulfate digestion converts all forms of nitrogen to nitrate. Sodium metabisulfite is added after the digestion to eliminate halogen oxide interferences. Nitrate then reacts with chromotropic acid under strongly acidic conditions to form a yellow complex with an absorbance maximum at 410 nm.

Consumables and Replacement Items

Required Reagents

Description	Unit	Cat. No.
Test 'N Tube™ Total Nitrogen Reagent Set	50 vials	26722-45

Required Apparatus

Description	Quantity/Test	Unit	Cat. No.
DRB200 Reactor, 110 V, 15 x 16 mm	1	each	LTV082.53.40001
DRB200 Reactor, 220 V, 15 x 16 mm	1	each	LTV082.52.40001
Funnel, micro	1	each	25843-35
Light Shield	1	each	LZV646
Pipet, TenSette®, 1.0 to 10.0 mL	1	each	19700-10
Pipet Tips, for TenSette Pipet 19700-10	2	50/pkg	21997-96
Test Tube Cooling Rack	1-3	each	18641-00

Recommended Standards and Apparatus

Description	Unit	Cat. No.
Ammonia Nitrogen Standard Solution, 1000-mg/L NH ₃ -N	1 L	23541-53
Ammonia Nitrogen Standard Solution, 10-mg/L NH ₃ -N	500 mL	153-49
Ammonia Nitrogen Standard Solution as N, 10 mg/L	500 mL	153-49
Primary Standard Set, for Kjeldahl Nitrogen	set of 3	22778-00
Wastewater Mixed Inorganic Standard for NH ₃ -H, NO ₃ -N, PO ₄ , COD, SO ₄ , TOC	500 mL	28331-49
Water, deionized	500 mL	272-49
Water, organic-free	500 mL	26415-49

Optional Reagents and Apparatus

Description	Unit	Cat. No.
Balance, analytical SA80, 115 VAC	each	28014-01
Cylinder, mixing with stopper, 50 mL	each	20886-41
Flask, volumetric, Class A, 1000 mL	each	14574-53
Pipet, TenSette, 0.1 to 1.0 mL	1	each
Pipet Tips, for TenSette Pipet 19700-01	2	50/pkg
Pipet tips for TenSette Pipet 19700-01	1000/pkg	21856-28
Pipet tips for TenSette Pipet 19700-10	250-pkg	21997-25
Sodium Hydroxide, 5 N	50 mL	2450-26
Sulfuric Acid, concentrated	500 mL	979-49



FOR TECHNICAL ASSISTANCE, PRICE INFORMATION AND ORDERING:

In the U.S.A. – Call toll-free 800-227-4224
Outside the U.S.A. – Contact the HACH office or distributor serving you.
On the Worldwide Web – www.hach.com; E-mail – techhelp@hach.com

HACH COMPANY
WORLD HEADQUARTERS
Telephone: (970) 669-3050
FAX: (970) 669-2932

Nitrogen, Total

Method 10208

Persulfate Digestion Method

TNTplus™ 826

LR (1 to 16 mg/L N)

Scope and Application: For water and wastewater



Test Preparation

Before starting the test:

Important Note: Install the light shield in Cell Compartment #2 before performing this test.

Read the Safety Advice and Expiration Date on the package.

Recommended sample and reagent temperature is 15–25 °C (59–77 °F). Recommended reagent storage temperature is 15–25 °C (59–77 °F).

Recommended sample pH is between 3–12.

Digestion is required for determining total nitrogen.

If test is not performed at the recommended temperature an incorrect result may be obtained.

Use only high quality deionized water or Organic Free Water for preparing nitrogen standards or making sample dilutions and reagent blanks.

TNTplus methods are activated from the Main Menu when the sample vial is inserted into the sample cell holder.

Important Note:

Sodium hydroxide solution A / Oxidant tablet B / MicroCap C:

After addition of reagents A, B and C the reagent bottles must be reclosed **immediately**.

Reaction Tubes (Ø 20 mm):

Do not use reaction tubes more than **13 times**. After use, clean thoroughly with a brush and water, then rinse well with nitrogen-free distilled water and dry.

Turbidity:

Slight turbidity does not interfere; high turbidity after the addition of the MicroCap C should be allowed to settle before pipetting the digested sample.

Collect the following items:

Quantity

Nitrogen, Total, LR TNT826 Reagent Set	1
DRB200 Reactor, 20-mm wells	1
Light Shield	1
Pipettor for 1–5 mL volumes	1
Pipettor Tips for 1–5 mL pipettor	2
Pipettor for 100–1000 µL sample	1
Pipettor Tips for 100–1000 µL pipettor	2

Note: Reorder information for consumables and replacement items is on page 4.

TNTplus

Method 10208

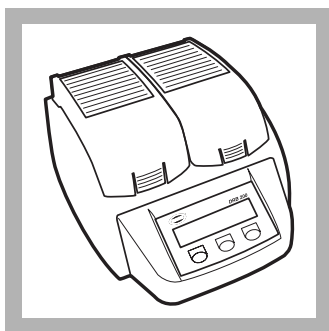

1. Turn on the DRB200 Reactor and heat to 100 °C.

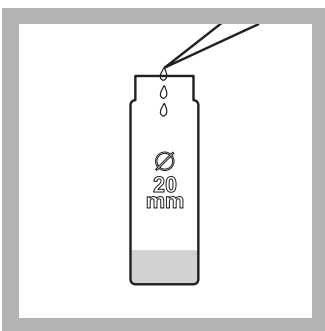

2. Add 1.3 mL of sample, 1.3 mL of Solution A, and 1 Reagent B tablet in quick succession to a dry 20-mm reaction tube.

Close the reaction tube immediately. **Do not invert.**



3. Insert the reaction tubes in the reactor. Heat for one hour.

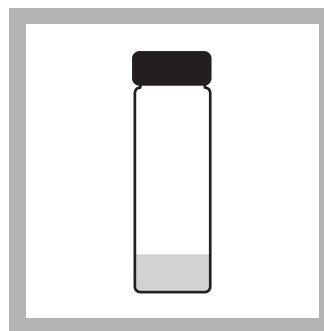

4. Remove the hot reaction tubes from the reactor. Cool the vials to room temperature (15–20 °C).

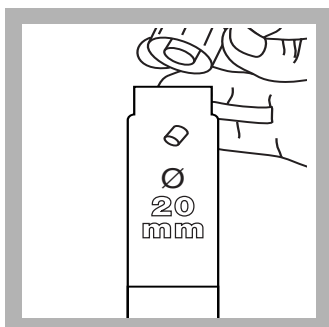

5. After the reaction tube has cooled, remove the cap and add 1 Micro Cap C to the tube.

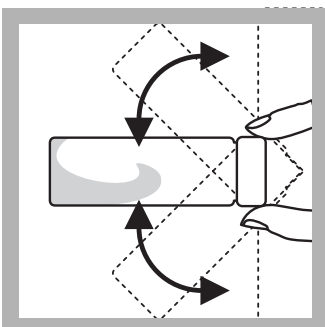

6. Cap and invert the reaction tube 2–3 times until no more streaks can be seen in the reaction tube solution.

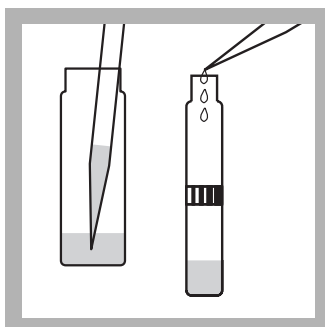

7. Pipet 0.5 mL (500 µL) of the digested sample from the reaction tube into a test vial.

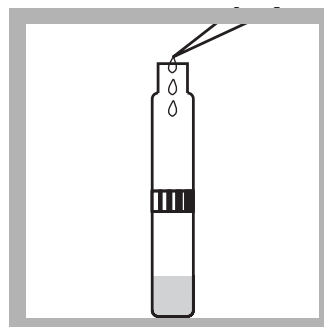

8. Pipet 0.2 mL (200 µL) of Solution D into the test vial.

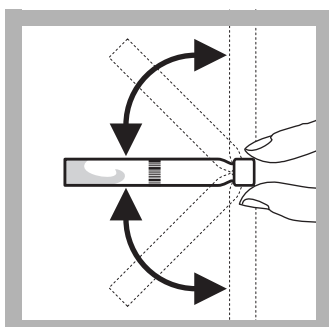

9. Quickly cap and invert the test vial 2–3 times until no more streaks can be seen in the vial solution.

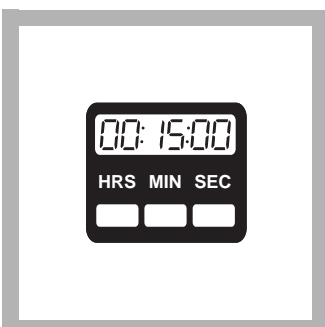

10. Wait 15 minutes. Install the Light Shield in Cell Compartment #2.

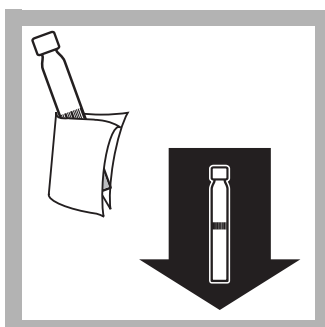

11. After the timer expires wipe the vial and Insert the prepared vial into the cell holder.

The instrument reads the barcode, then selects and performs the correct test. Results are in mg/L N.

No instrument zero is required.

Reagent Blanks

A reagent blank can be measured and the value subtracted from the results of each test performed using the same reagent lot number. Use nitrogen-free deionized water in place of sample and run the procedure as described.

To subtract the value of the blank from a series of measurements, measure the blank per step 11. Press **OPTIONS>MORE>REAGENT BLANK**. Press **ON**. The measured value of the blank should be displayed in the highlighted box. Press **OK** to accept this value. The reagent blank value will now be subtracted from all results until the function is turned off, or a different method is selected. Alternately, the blank can be recorded and entered at any later time by pressing the highlighted box and using the keypad to enter the value.

Interferences

The ions listed in Table 1 have been individually checked up to the given concentrations and do not cause interference. The cumulative effects of these ions or the influence of other ions have not been determined.

Table 1 Interfering Substances and Levels

Interfering Substance	Interference Level
COD	400 mg/L
Chloride	800 mg/L

Sample Collection, Storage, and Preservation

Collect samples in clean plastic or glass bottles. Best results are obtained with immediate analysis.

Preserve the sample by reducing the pH to 2 or less with concentrated (at least 2 mL/L) Sulfuric Acid. Store at 4 °C (39 °F) or less. Preserved samples may be stored up to 28 days. Warm samples to 15–25 °C and neutralize with 5 N Sodium Hydroxide before analysis. Correct the test result for volume additions.

Accuracy Check

Standard Solution Method

1. Check the accuracy of method with a 10 mg/L ammonia nitrogen standard. Use 1.3 mL this 10 mg/L standard in place of the sample in step 2.
2. Alternately, use 1.3 mL of a Wastewater Effluent Mixed Parameters Inorganics Standard in place of the sample in step 2. This standard contains 2 mg/L ammonia nitrogen and 4 mg/L nitrate nitrogen to give a combined standard of 6 mg/L as total nitrogen.

Summary of Method

Inorganically and organically bonded nitrogen is oxidized to nitrate by digestion with peroxodisulphate. The nitrate ions react with 2,6-dimethylphenol in a solution of sulphuric and phosphoric acid to form a nitrophenol. Test results are measured at 345 nm.

Nitrogen, Total LR (1 to 16 mg/L N)

Consumables and Replacement Items

Required Reagents

Description	Unit	Cat. No.
Nitrogen Total, LR TNT826 Reagent Set	25 vials	TNT826

Required Apparatus

Description	Quantity/Test	Unit	Cat. No.
DRB200 Reactor, 115 V, 9x13mm + 2x20 mm (mono block)	1	each	DRB200-01
OR			
DRB200 Reactor, 230 V, 9x13mm + 2x20 mm (mono block)	1	each	DRB200-05
Light Shield	1	each	LZV646
Pipet, variable, 1–5 mL	1	each	27951-00
Pipet Tips, for 27951-00 pipet	2	100/pkg	27952-00
Pipet, variable volume, 100–1000 µL	1	each	27949-00
Pipet Tips, for 27949-00 pipet	1	400/pkg	27950-00

Recommended Standards and Apparatus

Description	Unit	Cat. No.
Ammonia Nitrogen Standard Sol., 1000-mg/L NH ₃ -N	1 L	23541-53
Ammonia Nitrogen Standard Sol., 10-mg/L NH ₃ -N	500 mL	153-49
Sodium Hydroxide, 5 N	50 mL	2450-26
Sulfuric Acid	500 mL	979-49
Wastewater Mixed Inorganic Standard for NH ₃ -H, NO ₃ -N, PO ₄ , COD, SO ₄ , TOC	500 mL	28332-49
Water, deionized	500 mL	272-49
Water, organic-free	500 mL	26415-49

Optional Reagents and Apparatus

Description	Unit	Cat. No.
Bottle, sampling, low density poly, w/cap, 500 mL	12/pkg	20870-79
DRB200 Reactor, 115 V, 21x13mm + 4x20 mm (dual block)	each	DRB200-02
DRB200 Reactor, 115 V, 12x13mm + 8x20 mm (dual block)	each	DRB200-04
DRB200 Reactor, 230 V, 21x13mm + 4x20 mm (dual block)	each	DRB200-06
DRB200 Reactor, 230 V, 12x13mm + 8x20 mm (dual block)	each	DRB200-08
TNTplus Reactor adapter sleeves, 16-mm to 13-mm diameter	5/pkg	28958-05



FOR TECHNICAL ASSISTANCE, PRICE INFORMATION AND ORDERING:
In the U.S.A. – Call toll-free 800-227-4224
Outside the U.S.A. – Contact the HACH office or distributor serving you.
On the Worldwide Web – www.hach.com; E-mail – techhelp@hach.com

HACH COMPANY
WORLD HEADQUARTERS
Telephone: (970) 669-3050
FAX: (970) 669-2932

Nitrogen, Total

Method 10208

Persulfate Digestion Method

TNTplus™ 827

HR (5 to 40 mg/L N)

Scope and Application: For water and wastewater



Test Preparation

Before starting the test:

Important Note: Install the light shield in Cell Compartment #2 before performing this test.

Read the Safety Advice and Expiration Date on the package.

Recommended sample and reagent temperature is 15–25 °C (59–77 °F). Recommended reagent storage temperature is 15–25 °C (59–77 °F).

Recommended sample pH is between 3–12.

Digestion is required for determining total nitrogen.

If test is not performed at the recommended temperature an incorrect result may be obtained.

Use only high quality deionized water or Organic Free Water for preparing nitrogen standards or making sample dilutions and reagent blanks.

TNTplus methods are activated from the Main Menu when the sample vial is inserted into the sample cell holder.

Important Note:

Sodium hydroxide solution A / Oxidant tablet B / MicroCap C:

After addition of reagents A, B and C the reagent bottles must be reclosed **immediately**.

Reaction Tubes (20-mm):

Do not use reaction tubes more than **13 times**. After use, clean thoroughly with a brush and water, then rinse well with nitrogen-free distilled water and dry.

Turbidity:

Slight turbidity does not interfere; high turbidity after the addition of the MicroCap C should be allowed to settle before pipetting the digested sample.

Collect the following items:

Quantity

Nitrogen, Total, HR TNT827 Reagent Set	1
DRB200 Reactor, 20-mm wells	1
Light Shield	1
Pipettor for 1–5 mL volumes	1
Pipettor Tips for 1–5 mL pipettor	2
Pipettor for 100–1000 µL sample	1
Pipettor Tips for 100–1000 µL pipettor	2

Note: Reorder information for consumables and replacement items is on page 4.

TNTplus

Method 10208

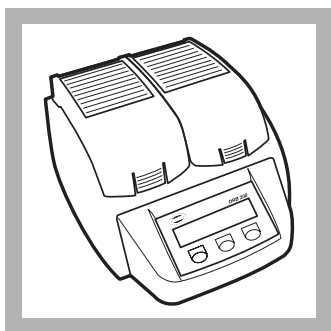

1. Turn on the DRB200 Reactor and heat to 100 °C.

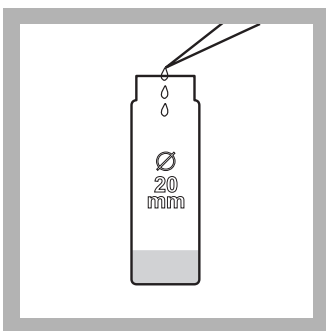

2. Add **10.5 mL** (500 μ L) of sample, **2.0 mL** of Solution A, and **1 Reagent B** tablet in quick succession to a dry 20-mm reaction tube.

Close the reaction tube immediately. **Do not invert.**

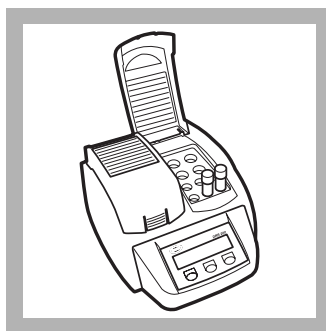

3. Insert the reaction tubes in the reactor. Heat for one hour.

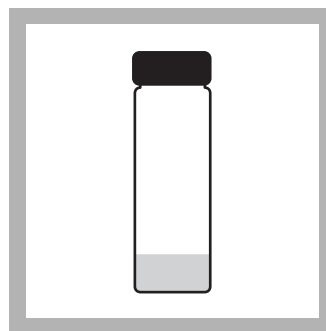

4. Remove the hot reaction tubes from the reactor. Cool the vials to room temperature (15–20 °C).

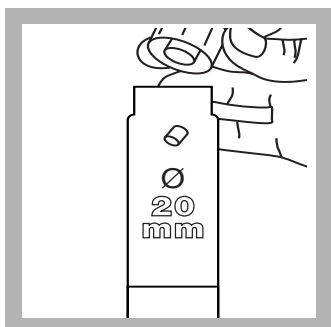

5. After the reaction tube has cooled, remove the cap and add 1 Micro Cap C to the tube.

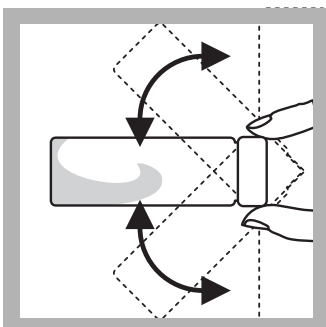

6. Cap and invert the reaction tube 2–3 times until no more streaks can be seen in the reaction tube solution.

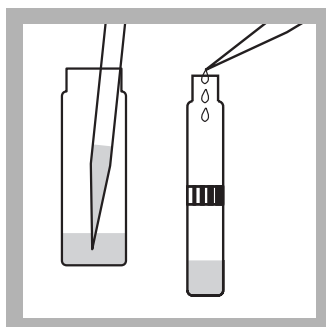

7. Pipet 0.5 mL (500 μ L) of the digested sample from the reaction tube into a test vial.

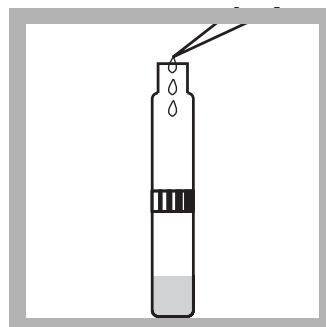

8. Pipet 0.2 mL (200 μ L) of Solution D into the test vial.

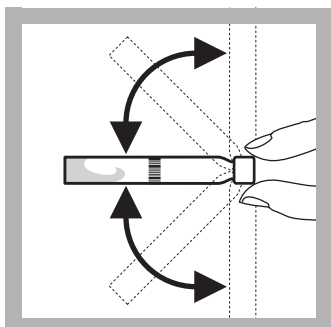

9. Quickly cap and invert the test vial 2–3 times until no more streaks can be seen in the vial solution.



10. Wait 15 minutes. Install the Light Shield in Cell Compartment #2.

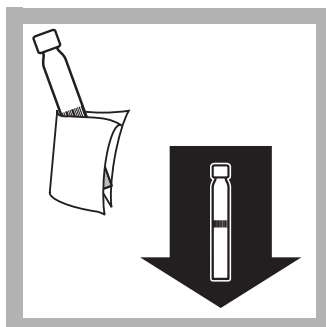

11. After the timer expires wipe the vial and insert the prepared vial into the cell holder.

The instrument reads the barcode, then selects and performs the correct test. Results are in mg/L N.

No instrument zero is required.

Reagent Blanks

A reagent blank can be measured and the value subtracted from the results of each test performed using the same reagent lot number. Use nitrogen-free deionized water in place of sample and run the procedure as described.

To subtract the value of the blank from a series of measurements, measure the blank per step 11. Press **OPTIONS>MORE>REAGENT BLANK**. Press **ON**. The measured value of the blank should be displayed in the highlighted box. Press **OK** to accept this value. The reagent blank value will now be subtracted from all results until the function is turned off, or a different method is selected. Alternately, the blank can be recorded and entered at any later time by pressing the highlighted box and using the keypad to enter the value.

Interferences

The ions listed in Table 1 have been individually checked up to the given concentrations and do not cause interference. The cumulative effects of these ions or the influence of other ions have not been determined.

Table 1 Interfering Substances and Levels

Interfering Substance	Interference Level
COD	1000 mg/L
Chloride	2000 mg/L

Sample Collection, Storage, and Preservation

Collect samples in clean plastic or glass bottles. Best results are obtained with immediate analysis.

Preserve the sample by reducing the pH to 2 or less with concentrated (at least 2 mL/L) Sulfuric Acid. Store at 4 °C (39 °F) or less. Preserved samples may be stored up to 28 days. Warm samples to 15–25 °C and neutralize with 5 N Sodium Hydroxide before analysis. Correct the test result for volume additions.

Accuracy Check

Standard Solution Method

1. Check the accuracy of method with a 10 mg/L ammonia nitrogen standard. Use 0.5 mL this 10 mg/L standard in place of the sample in step 2.
2. Alternately, use 0.5 mL of a Wastewater Effluent Mixed Parameters Inorganics Standard in place of the sample in step 2. This standard contains 15 mg/L ammonia nitrogen and 10 mg/L nitrate nitrogen to give a combined standard of 25 mg/L as total nitrogen.

Summary of Method

Inorganically and organically bonded nitrogen is oxidized to nitrate by digestion with peroxodisulphate. The nitrate ions react with 2,6-dimethylphenol in a solution of sulphuric and phosphoric acid to form a nitrophenol. Test results are measured at 345 nm.

Nitrogen, Total HR (5 to 40 mg/L N)

Consumables and Replacement Items

Required Reagents

Description	Unit	Cat. No.
Nitrogen Total, HR TNT827 Reagent Set	25/pkg	TNT827

Required Apparatus

Description	Quantity/Test	Unit	Cat. No.
DRB200 Reactor, 115 V, 9x13mm + 2x20 mm (mono block)	1	each	DRB200-01
OR			
DRB200 Reactor, 230 V, 9x13mm + 2x20 mm (mono block)	1	each	DRB200-05
Light Shield	1	each	LZV646
Pipet, variable, 1–5 mL	1	each	27951-00
Pipet Tips, for 27951-00 pipet	2	100/pkg	27952-00
Pipet, variable volume, 100–1000 µL	1	each	27949-00
Pipet Tips, for 27949-00 pipet	1	400/pkg	27950-00

Recommended Standards and Apparatus

Description	Unit	Cat. No.
Ammonia Nitrogen Standard Sol., 1000-mg/L NH ₃ -N	1 L	23541-53
Ammonia Nitrogen Standard Sol., 10-mg/L NH ₃ -N	500 mL	153-49
Sodium Hydroxide, 5 N	50 mL	2450-26
Sulfuric Acid	500 mL	979-49
Wastewater, Influent, Mixed Inorganic Standard for NH ₃ -H, NO ₃ -N, PO ₄ , COD, SO ₄ , TOC	500 mL	28331-49
Water, deionized	500 mL	272-49
Water, organic-free	500 mL	26415-49

Optional Reagents and Apparatus

Description	Unit	Cat. No.
Bottle, sampling, low density poly, w/cap, 500 mL	12/pkg	20870-79
DRB200 Reactor, 115 V, 21x13mm + 4x20 mm (dual block)	each	DRB200-02
DRB200 Reactor, 115 V, 12x13mm + 8x20 mm (dual block)	each	DRB200-04
DRB200 Reactor, 230 V, 21x13mm + 4x20 mm (dual block)	each	DRB200-06
DRB200 Reactor, 230 V, 12x13mm + 8x20 mm (dual block)	each	DRB200-08
TNTplus Reactor adapter sleeves, 16-mm to 13-mm diameter	5/pkg	28958-05



FOR TECHNICAL ASSISTANCE, PRICE INFORMATION AND ORDERING:
In the U.S.A. – Call toll-free 800-227-4224
Outside the U.S.A. – Contact the HACH office or distributor serving you.
On the Worldwide Web – www.hach.com; E-mail – techhelp@hach.com

HACH COMPANY
WORLD HEADQUARTERS
Telephone: (970) 669-3050
FAX: (970) 669-2932

Nitrogen, Total

Method 10208

Persulfate Digestion Method

TNTplus™ 828

UHR (20 to 100 mg/L N)

Scope and Application: For water and wastewater



Test Preparation

Before starting the test:

Important Note: Install the light shield in Cell Compartment #2 before performing this test.

Read the Safety Advice and Expiration Date on the package.

Recommended sample and reagent temperature is 15–25 °C (59–77 °F). Recommended reagent storage temperature is 15–25 °C (59–77 °F).

Recommended sample pH is between 3–12.

Digestion is required for determining total nitrogen.

If test is not performed at the recommended temperature an incorrect result may be obtained.

Use only high quality deionized water or Organic Free Water for preparing nitrogen standards or making sample dilutions and reagent blanks.

TNTplus methods are activated from the Main Menu when the sample vial is inserted into the sample cell holder.

Important Note:

Sodium hydroxide solution A / Oxidant tablet B / MicroCap C:

After addition of reagents A, B and C the reagent bottles must be reclosed **immediately**.

Reaction Tubes (20-mm):

Do not use reaction tubes more than **13 times**. After use, clean thoroughly with a brush and water, then rinse well with nitrogen-free distilled water and dry.

Turbidity:

Slight turbidity does not interfere; high turbidity after the addition of the MicroCap C should be allowed to settle before pipetting the digested sample.

Collect the following items:

Quantity

Nitrogen, Total, UHR TNT828 Reagent Set	1
DRB200 Reactor, 20-mm wells	1
Light Shield	1
Pipet for 1–5 mL volumes	1
Pipet Tips for 1–5 mL pipettor	2
Pipet for 100–1000 µL sample	1
Pipet Tips for 100–1000 µL pipettor	2

Note: Reorder information for consumables and replacement items is on page 4.

TNTplus

Method 10208

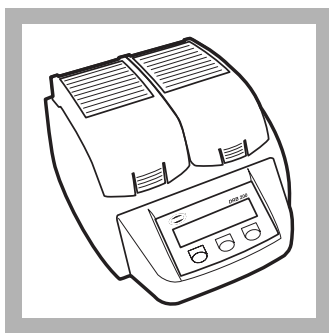

1. Turn on the DRB200 Reactor and heat to 100 °C.

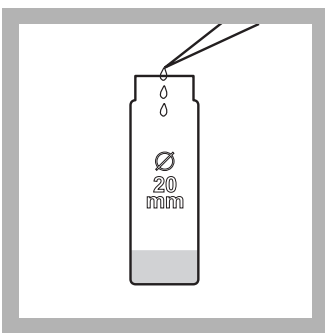

2. Add **0.2 mL** (200 µL) of sample, **2.3 mL** of Solution A, and **1** Reagent B tablet in quick succession to a dry 20-mm reaction tube.

Close the reaction tube immediately. Do not invert.

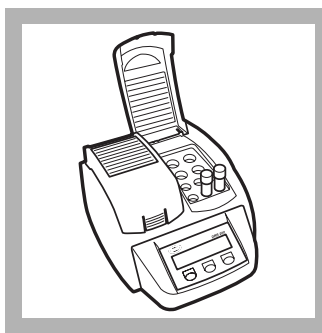

3. Insert the reaction tubes in the reactor. Heat for one hour.

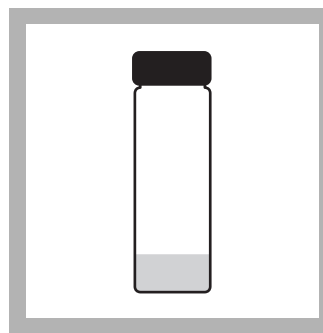

4. Remove the hot reaction tubes from the reactor. Cool the vials to room temperature (15–20 °C).

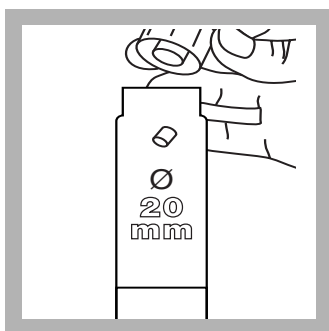

5. After the reaction tube has cooled, remove the cap and add **one** Micro Cap C to the tube.

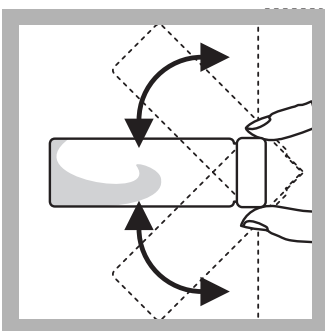

6. Cap and invert the reaction tube 2–3 times until no more streaks can be seen in the reaction tube solution.

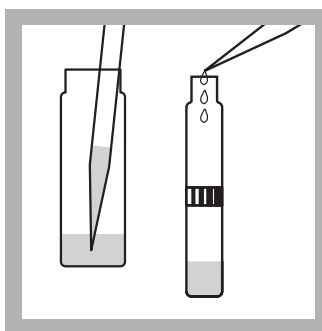

7. Pipet 0.5 mL (500 µL) of the digested sample from the reaction tube into a test vial.

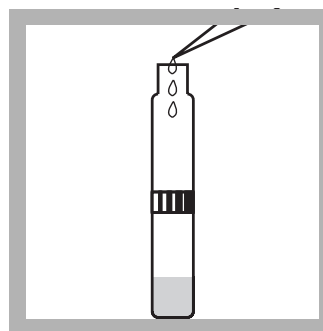

8. Pipet 0.2 mL (200 µL) of Solution D into the test vial.

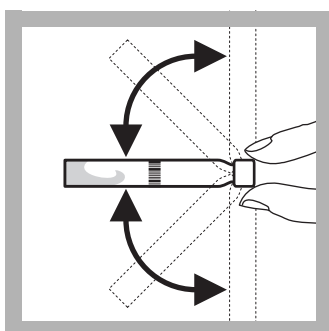

9. Quickly cap and invert the test vial 2–3 times until no more streaks can be seen in the vial solution.

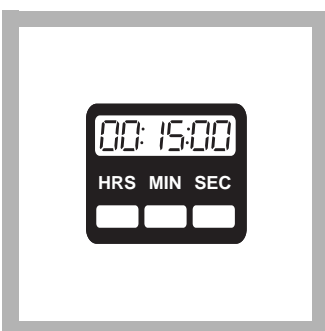

10. Wait 15 minutes. Install the Light Shield in Cell Compartment #2.

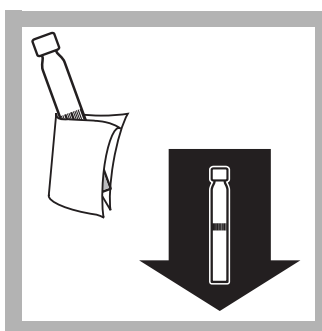

11. After the timer expires wipe the vial and insert the prepared vial into the cell holder.

The instrument reads the barcode, then selects and performs the correct test. Results are in mg/L N.

No instrument zero is required.

Reagent Blanks

A reagent blank can be measured and the value subtracted from the results of each test performed using the same reagent lot number. Use nitrogen-free deionized water in place of sample and run the procedure as described.

To subtract the value of the blank from a series of measurements, measure the blank per step 11. Press **OPTIONS>MORE>REAGENT BLANK**. Press **ON**. The measured value of the blank should be displayed in the highlighted box. Press **OK** to accept this value. The reagent blank value will now be subtracted from all results until the function is turned off, or a different method is selected. Alternately, the blank can be recorded and entered at any later time by pressing the highlighted box and using the keypad to enter the value.

Interferences

The ions listed in Table 1 have been individually checked up to the given concentrations and do not cause interference. The cumulative effects of these ions or the influence of other ions have not been determined.

Table 1 Interfering Substances and Levels

Interfering Substance	Interference Level
COD	2500 mg/L
Chloride	5000 mg/L

Sample Collection, Storage, and Preservation

Collect samples in clean plastic or glass bottles. Best results are obtained with immediate analysis.

Preserve the sample by reducing the pH to 2 or less with concentrated (at least 2 mL/L) Sulfuric Acid. Store at 4 °C (39 °F) or less. Preserved samples may be stored up to 28 days. Warm samples to 15–25 °C and neutralize with 5 N Sodium Hydroxide before analysis. Correct the test result for volume additions.

Accuracy Check

Standard Solution Method

1. Check the accuracy of method with a 50 mg/L ammonia nitrogen standard. Prepare the standard by pipetting 5.0 mL of a 1000 mg/L ammonia nitrogen standard into a 100 mL volumetric flask. Dilute to volume with deionized water, stopper and invert to mix. Use 0.2 mL this 50 mg/L standard in place of the sample in step 2. A 50-mg/L ammonia nitrogen standard solution is also available.
2. Alternately, use 0.2 mL of a Wastewater Influent Mixed Parameters Inorganics Standard in place of the sample in step 2. This standard contains 15 mg/L ammonia nitrogen and 10 mg/L nitrate nitrogen to give a combined standard of 25 mg/L as total nitrogen.

Summary of Method

Inorganically and organically bonded nitrogen is oxidized to nitrate by digestion with peroxydisulphate. The nitrate ions react with 2,6-dimethylphenol in a solution of sulphuric and phosphoric acid to form a nitrophenol. Test results are measured at 345 nm.

Nitrogen, Total UHR (20 to 100 mg/L N)

Consumables and Replacement Items

Required Reagents

Description	Unit	Cat. No.
Nitrogen Total, UHR TNT828 Reagent Set	25/pkg	TNT828

Required Apparatus

Description	Quantity/Test	Unit	Cat. No.
DRB200 Reactor, 115 V, 9x13 mm + 2x20 mm (mono block)	1	each	DRB200-01
OR			
DRB200 Reactor, 230 V, 9x13 mm + 2x20 mm (mono block)	1	each	DRB200-05
Light Shield	1	each	LZV646
Pipet, variable, 1–5 mL	1	each	27951-00
Pipet Tips, for 27951-00 pipet	2	100/pkg	27952-00
Pipet, variable volume, 100–1000 µL	1	each	27949-00
Pipet Tips, for 27949-00 pipet	1	400/pkg	27950-00
Test Tube Cooling Rack	1–3	each	18641-00

Recommended Standards and Apparatus

Description	Unit	Cat. No.
Ammonia Nitrogen Standard Sol., 1000-mg/L NH ₃ -N	1 L	23541-53
Ammonia Nitrogen Standard, 50 mg/L NH ₃ -N, 2-mL ampules	20/pkg	14791-20
Ammonia Nitrogen Standard, 50 mg/L NH ₃ -N, 10-mL ampules	16/pkg	14791-10
Sulfuric Acid	500 mL	979-49
Wastewater Influent Mixed Inorganic Standard for NH ₃ -H, NO ₃ -N, PO ₄ , COD, SO ₄ , TOC	500 mL	28331-49
Water, deionized	500 mL	272-49
Water, organic-free	500 mL	26415-49

Optional Reagents and Apparatus

Description	Unit	Cat. No.
Bottle, sampling, low density poly, w/cap, 500 mL	12/pkg	20870-79
DRB200 Reactor, 115 V, 21x13 mm + 4x20 mm (dual block)	each	DRB200-02
DRB200 Reactor, 115 V, 12x13 mm + 8x20 mm (dual block)	each	DRB200-04
DRB200 Reactor, 230 V, 21x13 mm + 4x20 mm (dual block)	each	DRB200-06
DRB200 Reactor, 230 V, 12x13 mm + 8x20 mm (dual block)	each	DRB200-08
Pipet, volumetric 5.0 mL	each	14515-37
Pipet Filler, safety bulb	each	14651-00
Flask, volumetric, 100 mL	each	14574-42
TNTplus Reactor adapter sleeves, 16-mm to 13-mm diameter	5/pkg	28958-05



FOR TECHNICAL ASSISTANCE, PRICE INFORMATION AND ORDERING:
In the U.S.A. – Call toll-free 800-227-4224
Outside the U.S.A. – Contact the HACH office or distributor serving you.
On the Worldwide Web – www.hach.com; E-mail – techhelp@hach.com

HACH COMPANY
WORLD HEADQUARTERS
Telephone: (970) 669-3050
FAX: (970) 669-2932

Nitrogen, Total Inorganic

Method 10021

Titanium Trichloride Reduction Method

Test 'N Tube™ Vials

(0.2 to 25.0 mg/L N)

Scope and Application: For water, wastewater, and seawater



Test Preparation

Before starting the test:

Important Note: Install the light shield in Cell Compartment #2 before performing this test.

For safety, wear gloves while breaking ampules.

The ammonia salicylate reagent contains sodium nitroferricyanide. Cyanide solutions are regulated as hazardous wastes by the Federal RCRA. Collect cyanide solutions for disposal as reactive (D001) waste. Be sure cyanide solutions are stored in a caustic solution with pH >11 to prevent release of hydrogen cyanide gas. Refer to the current MSDS for safe handling and disposal information.

Collect the following items:

Quantity

Total Inorganic Nitrogen Pretreatment Reagent Set (TiCl ₃ Reduction Method)	1
Test 'N Tube™ AmVer™ Nitrogen-Ammonia Reagent Set	1
Water, deionized	1 mL
Centrifuge	1
Funnel, micro	1
Light Shield	1
Pipet, TenSette®, 1.0–10.0 mL with tips	1
Pipette, volumetric, Class A, 1.00-mL	1
Test Tube Rack	1–3

Note: Reorder information for consumables and replacement items is on page 6.

Test 'N Tube

Method 10021

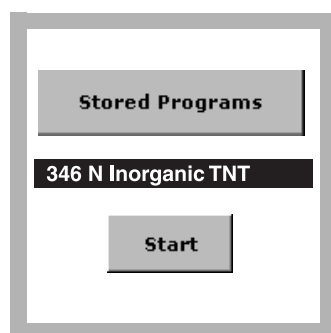

1. Select the test.

Install the Light Shield in Cell Compartment #2.

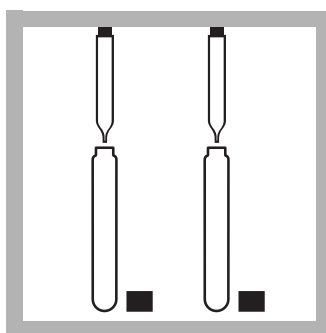

2. Pipet 1 mL of Total Inorganic Nitrogen Pretreatment Base concentrate into each of two Total Inorganic Nitrogen Pretreatment Diluent Vials.

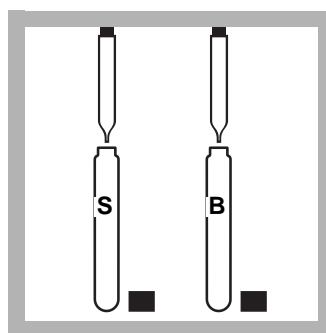

3. **Prepared Sample:**
Pipet 1 mL of sample into one vial.

Blank Preparation:
Pipet 1 mL of deionized water into the second vial.

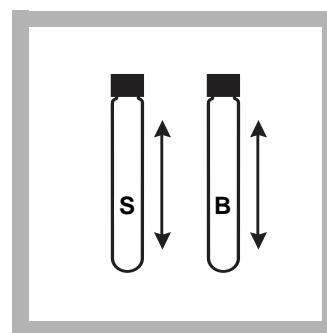

4. Cap the vials and shake for 30 seconds to mix.

Nitrogen, Total Inorganic (0.2 to 25.0 mg/L N)

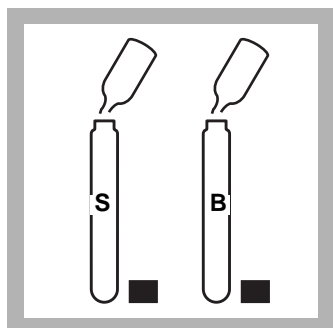

5. Pour the contents of one Total Inorganic Nitrogen Reductant ampule into the vial containing the sample.

Pour the contents of another Total Inorganic Nitrogen Reductant ampule into the vial containing the blank.

A black precipitate will form immediately.

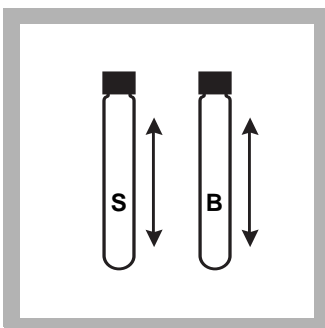

6. Immediately cap the vials. Shake gently for 30 seconds to mix the reagents. Allow the vials to stand for at least one minute.

The precipitate should remain black after shaking. Excessive shaking will cause the precipitate to turn white and cause low results.



7. Place the vials in a centrifuge.

(If you do not have a centrifuge, wait at least 30 minutes for the solids to settle at the bottom of the vial. Proceed to step 9.)

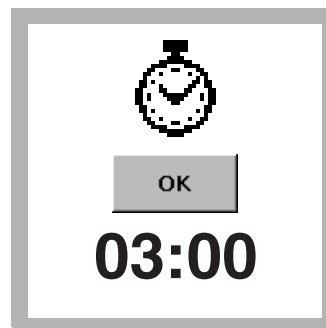

8. Press **TIMER>OK**.

A three-minute timer will begin.

Centrifuge the vials for three minutes.

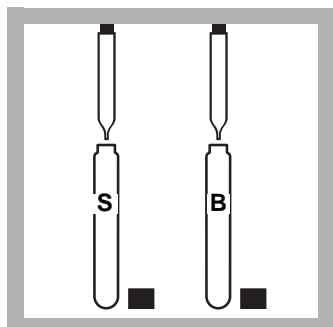

9. Using a pipet, add 2 mL of centrifuged sample to an AmVer™ Diluent Reagent Test 'N Tube™ for Low Range Ammonia Nitrogen.

Add 2 mL of centrifuged blank to another AmVer™ Diluent Reagent Test 'N Tube™ for Low Range Ammonia Nitrogen.

Pipet carefully to avoid disturbing the sediment.

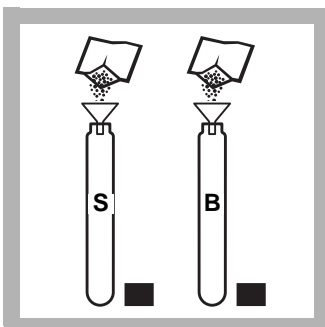

10. Using a funnel, add the contents of one Ammonia Salicylate Reagent Powder Pillow (for 5-mL samples) to each vial.

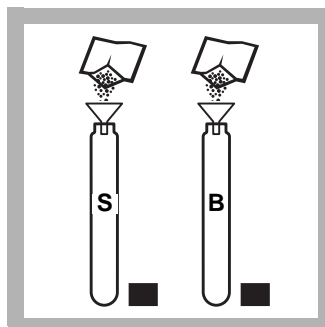

11. Using a funnel, add the contents of one Ammonia Cyanurate Reagent Powder Pillow (for 5-mL samples) to each vial.

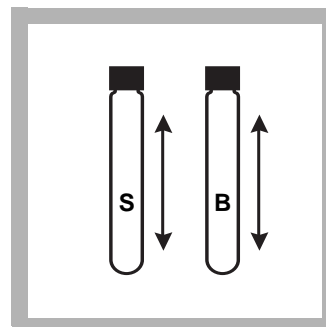

12. Cap the vials tightly and shake thoroughly to dissolve the powder.

A green color will develop if nitrogen is present.

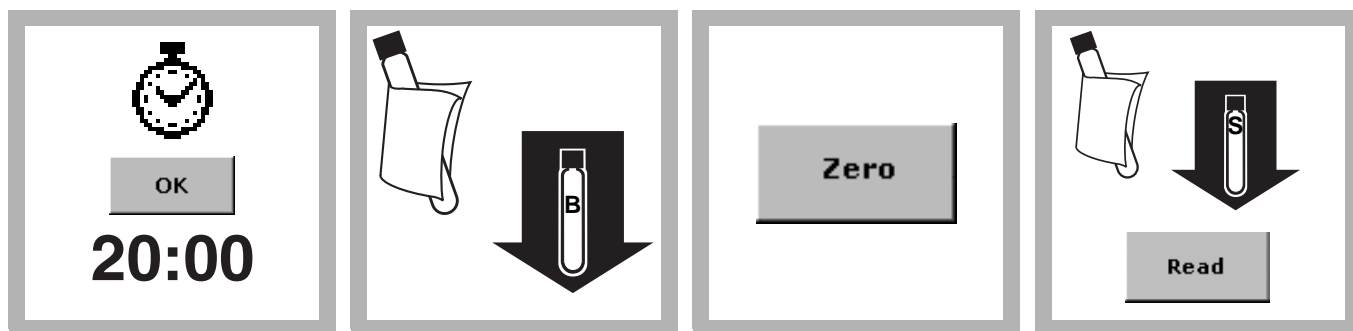

13. Press **TIMER>OK**.

A 20-minute reaction period will begin.

14. When the timer expires, wipe the blank and insert it into the 16-mm round cell holder.

15. Press **ZERO**.

The display will show:
0.0 mg/L N

16. Wipe the prepared sample and insert it into the 16-mm round cell holder.

Press **READ**. Results are in mg/L N.

Interferences

The substances in [Table 1](#) may interfere when present. The substances in [Table 2](#) do not interfere below the levels listed.

Table 1 Interfering Substances and Levels

Interfering Substance	Interference Levels and Treatments
Calcium	Causes a positive interference at 1000 mg/L as CaCO ₃ .
Manganese (IV)	Causes a negative interference at 3 mg/L.
Magnesium	Causes a positive interference at 1000 mg/L as CaCO ₃ .
Sulfide	Causes a negative interference at 3 mg/L.
Sulfate	Causes a negative interference at 250 mg/L.

Table 2 Non-interfering Substances and Levels

Substance	Levels Tested
Al ³⁺	8 mg/L
Ba ²⁺	40 mg/L
Cu ²⁺	40 mg/L
Fe ³⁺	8 mg/L
Zn ²⁺	80 mg/L
F ⁻	40 mg/L
PO ₄ ³⁻ -P	8 mg/L
SiO ₂	80 mg/L
EDTA	80 mg/L

Sample Collection, Preservation, and Storage

Collect samples in clean plastic or glass bottles. Best results are obtained with immediate analysis. If chlorine is known to be present, add one drop of 0.1 N Sodium Thiosulfate* for each 0.3 mg/L Cl₂ in a one-liter sample. Preserve the sample by reducing the pH to 2 or less with concentrated (at least 2 mL) Hydrochloric Acid*. Store at 4 °C (39 °F) or less. Preserved samples may be stored up to 28 days. Warm samples to room temperature. Neutralize with 5 N Sodium Hydroxide* before analysis. Correct the test result for volume additions.

Accuracy Check

Standard Additions Method

1. After reading test results, leave the sample cell (unspiked sample) in the instrument.
2. Press **OPTIONS>MORE**. Press **STANDARD ADDITIONS**. A summary of the standard additions procedure will appear.
3. Press **OK** to accept the default values for standard concentration, sample volume, and spike volumes. Press **EDIT** to change these values. After values are accepted, the unspiked sample reading will appear in the top row. See the user manual for more information.
4. Snap the neck off a fresh HR Nitrate Nitrogen PourRite Ampule Standard, 500-mg/L NO₃⁻-N.
5. Prepare three sample spikes. Fill three mixing cylinders* with 25 mL of sample. Use the TenSette Pipet to add 0.1 mL, 0.2 mL, and 0.3 mL of standard, respectively, to each sample and mix thoroughly.
6. Analyze each sample spike as described in the procedure above, starting with the 0.1 mL sample spike. Accept each standard additions reading by pressing **READ**. Each addition should reflect approximately 100% recovery.
7. After completing the sequence, press **GRAPH** to view the best-fit line through the standard additions data points, accounting for matrix interferences. Press **IDEAL LINE** to view the relationship between the sample spikes and the "Ideal Line" of 100% recovery.

Standard Solution Method

1. To check accuracy, use a 10.0-mg/L Nitrate Nitrogen Standard Solution. Alternatively, prepare this by diluting 1 mL of solution from a Nitrate Nitrogen Voluette® Ampule Standard, 500-mg/L NO₃⁻-N, to 50 mL with deionized water. Perform the procedure as described above.
2. To adjust the calibration curve using the reading obtained with the standard solution, press **OPTIONS>MORE** on the current program menu. Press **STANDARD ADJUST**.
3. Press **ON**. Press **ADJUST** to accept the displayed concentration. If an alternate concentration is used, press the number in the box to enter the actual concentration, then press **OK**. Press **ADJUST**.

* See [Optional Reagents and Apparatus on page 6](#).

Method Performance

The total inorganic nitrogen test is designed to provide an estimate of the total nitrite, nitrate, and ammonia nitrogen load present in a water or wastewater sample. This test is most applicable to the monitoring of samples taken from an industrial process stream or a wastewater treatment stream where it is important to track the inorganic nitrogen load as it passes through the treatment process. The test does exhibit different recoveries of each of the three nitrogen species, as summarized below. The test is not recommended for use when quantifying only one of the three species. In that case, specific procedures for each particular analyte would be more appropriate.

Species Recovery

Nitrogen Form	Recovery
NH ₃ -N	112%
NO ₃ ⁻ -N	100%
NO ₂ ⁻ -N	77%

Summary of Method

Titanium (III) ions reduce nitrate and nitrite to ammonia in a basic environment. After centrifugation to remove solids, the ammonia is combined with chlorine to form monochloramine. Monochloramine reacts with salicylate to form 5-aminosalicylate. The 5-aminosalicylate is oxidized in the presence of a sodium nitroprusside catalyst to form a blue colored compound. The blue color is masked by the yellow color from the excess reagent present to give a final green colored solution. Test results are measured at 655 nm.

Nitrogen, Total Inorganic (0.2 to 25.0 mg/L N)

Consumables and Replacement Items

Required Reagents

Description	Quantity/Test	Unit	Cat. No.
Total Inorganic Nitrogen Pretreatment Reagent Set (TiCl ₃ Reduction Method)	—	25 tests	26049-45
Test 'N Tube™ AmVer™ Nitrogen-Ammonia Reagent Set	—	25 tests	26045-45
Water, deionized	1 mL	100 mL	272-42

Required Apparatus

Description	Quantity/Test	Unit	Cat. No.
Centrifuge, 115 VAC, 6 x 15 mL OR	1	each	26765-00
Centrifuge, 220 VAC, 6 x 15 mL	1	each	26765-02
Funnel, micro	1	each	25843-35
Light Shield	1	each	LZV646
Pipet, TenSette®, 1.0–10.0 mL	1	each	19700-10
Pipet Tips, for TenSette Pipet 19700-10	varies	50/pkg	21997-96
Pipette, volumetric, Class A, 1.00-mL	1	each	14515-35
Test Tube Rack	1	each	18641-00

Recommended Standards and Apparatus

Description	Unit	Cat. No.
Flask, volumetric Class A, 50-mL	each	14574-41
Nitrate Nitrogen Standard Solution, 10-mg/L NO ₃ ⁻ -N	500 mL	307-49
Nitrate Nitrogen Standard Solution, 2-mL Ampule, 500-mg/L NO ₃ ⁻ -N	20/pkg	14260-20
Pipet Filler, safety bulb	each	14651-00
Pipet, TenSette, 0.1–1.0 mL	each	19700-01
Pipet Tips, for TenSette Pipet 19700-01	50/pkg	21856-96
Pipet Tips, for TenSette Pipet 19700-01	1000/pkg	21856-28
Pipet Tips, for TenSette Pipet 19700-10	250-pkg	21997-28
Pipet, volumetric Class A, 1.00 mL	each	14515-35
Water, deionized	4 liters	272-56

Optional Reagents and Apparatus

Description	Cat. No.
Cylinder, mixing	20886-40
Hydrochloric Acid, concentrated	134-49
Sodium Hydroxide, 5.0 N	2450-26
Sodium Thiosulfate, 0.1 N	323-32



FOR TECHNICAL ASSISTANCE, PRICE INFORMATION AND ORDERING:
In the U.S.A. – Call toll-free 800-227-4224
Outside the U.S.A. – Contact the HACH office or distributor serving you.
On the Worldwide Web – www.hach.com; E-mail – techhelp@hach.com

HACH COMPANY
WORLD HEADQUARTERS
Telephone: (970) 669-3050
FAX: (970) 669-2932

Nitrogen, Total Kjeldahl

Method 8075

Nessler Method¹ (Digestion Required)

(1 to 150 mg/L)

Scope and Application: For water, wastewater, and sludge; digestion is required.

¹ Adapted from Hach, et. al., *Journal of Association of Official Analytical Chemists*, 70(5) 783-787 (1987); Hach, et. al., *Journal of Agricultural and Food Chemistry*, 33(6) 1117-1123 (1985); *Standard Methods for the Examination of Water and Wastewater*



Test Preparation

Before starting the test:

For more accurate results, determine a reagent blank value for each new lot of reagent. Follow the procedure using deionized water in place of the sample. Subtract the reagent blank value from the final results or perform a reagent blank adjust.

If using the Pour-Thru Module, periodically clean the cell by pouring a few sodium thiosulfate pentahydrate crystals into the cell funnel. Flush it through the funnel and cell with enough deionized water to dissolve. Rinse out the crystals.

Hold droppers and dropper bottles vertically, **not at an angle**, when dispensing reagent.

Nessler reagent contains mercuric iodide. Both the sample and blank will contain mercury (D009) at concentrations regulated as a hazardous waste by the Federal RCRA. Do not pour these solutions down the drain. Refer to the current MSDS for safe handling and disposal instructions.

Collect the following items:

Quantity

Boiling Chips, silica carbide	2–3
Cots, finger	2
Cylinder, graduated mixing, 25 mL	2
Digesdahl Digestion Apparatus	1
Hydrogen Peroxide, 50%	20 mL
Mineral Stabilizer	6 drops
Nesslers Reagent	2 mL
Polyvinyl Alcohol Dispersing Agent	varies
Potassium Hydroxide Standard Solution, 1.0 N	varies
Potassium Hydroxide Standard Solution, 8.0 N	varies
Sulfuric Acid, ACS, concentrated	6 mL
TKN Indicator Solution	2 drops
Pipet, TenSette®, 0.1–1.0 mL, plus tips	1
Safety Shield	1
Sample Cell, 1-inch square, 10-mL	2

Note: Reorder information for consumables and replacement items is on page 6.

Nessler

Method 8075



1. Press **STORED PROGRAMS**.

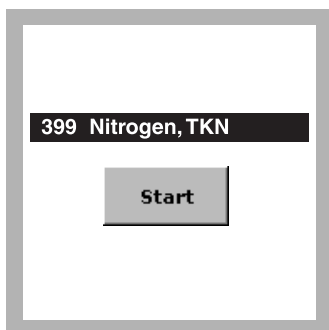

2. Select the test.

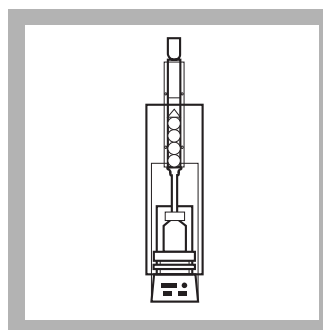

3. Prepared Sample:
Digest the sample amount as described in the Digesdahl® Digestion Apparatus Instruction Manual.

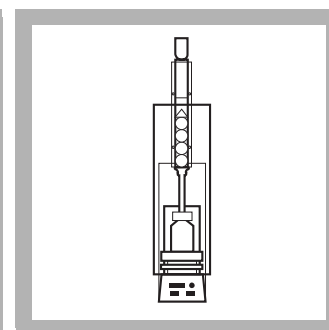

4. Blank Preparation:
Digest an equal amount of deionized water as the blank.

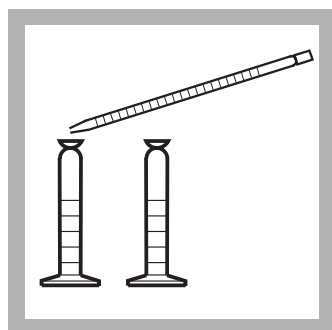

5. Select the appropriate analysis volume of the digested sample given in [Table 3 on page 4](#). Pipet the analysis volume from the sample and the blank into separate 25-mL mixing graduated cylinders.

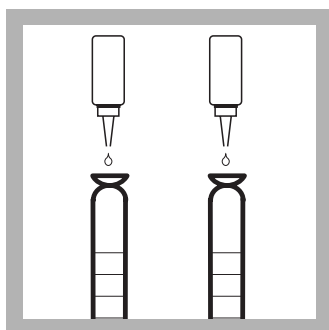

6. Add one drop of TKN Indicator to each cylinder.

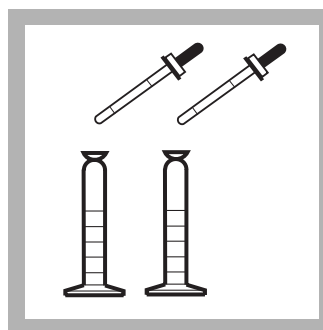

7. If the aliquot is less than 1 mL, proceed to step 8.
If it is greater than 1 mL, add drops of 8.0 N KOH to each cylinder until the first flash of blue color appears. Stopper and invert the cylinder after each addition. Proceed to the next step.

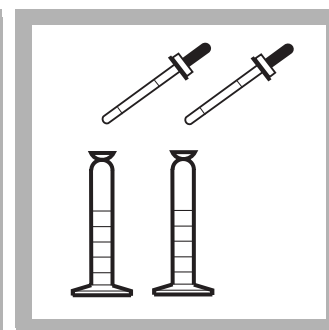

8. Add 1.0 N KOH to each cylinder, one drop at a time, mixing after each addition. Continue until the first permanent blue color appears.

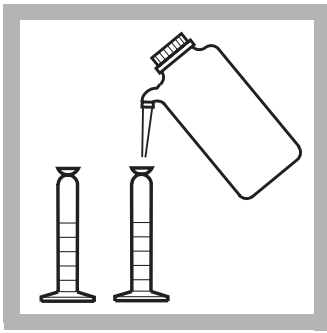

9. Fill both cylinders to the 20-mL mark with deionized water.

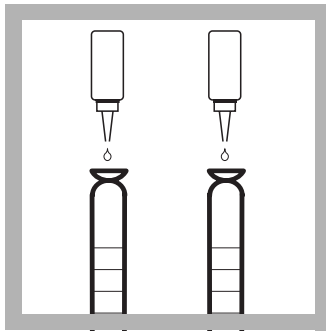

10. Add three drops of Mineral Stabilizer to each cylinder. Stopper and invert several times to mix.

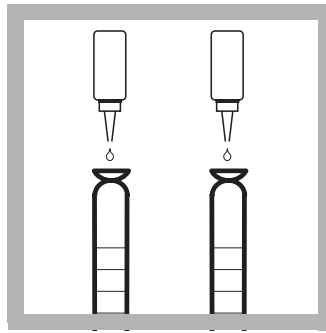

11. Add three drops of Polyvinyl Alcohol Dispersing Agent to each cylinder. Stopper and invert several times to mix.

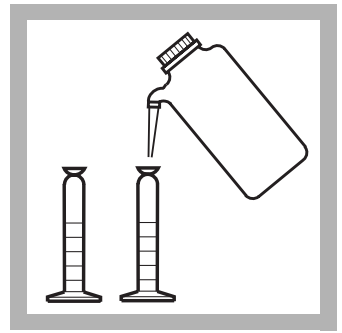

12. Fill both cylinders to the 25-mL mark with deionized water. Stopper and invert several times to mix.

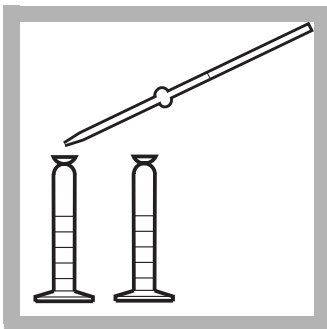

13. Pipet 1.00 mL of Nessler's Reagent to each cylinder. Stopper and invert repeatedly.

The solution should not be hazy. Any haze (turbidity) will cause incorrect results.

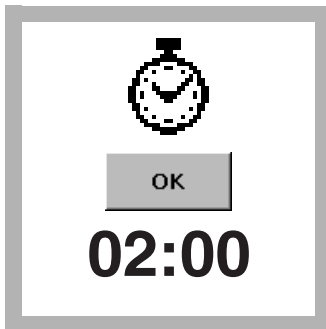

14. Press **TIMER>OK**. A two-minute reaction period will begin.

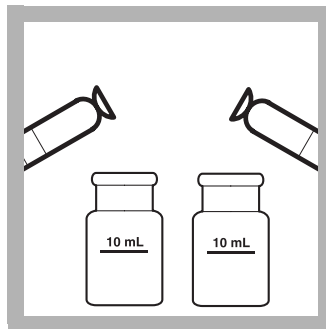

15. When the timer expires, pour the contents of each cylinder into separate square sample cells.



16. Wipe the blank and insert it into the cell holder with the fill line facing right.

Nitrogen, Total Kjeldahl (1 to 150 mg/L)

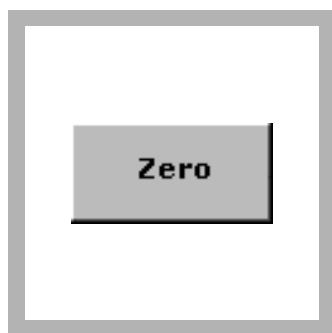

17. Press **ZERO**. The display will show:
0 mg/L TKN



18. Wipe the prepared sample and insert it into the cell holder with the fill line facing right.

Press **READ**. Results are in mg/L TKN.

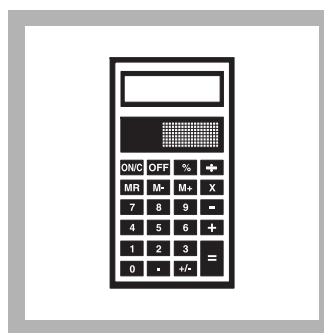

19. Calculate sample TKN as follows:

$$\text{ppm TKN} = \frac{75 \times A}{B \times C}$$

Where:

A = mg/L read from the display

B = g (or mL of water) sample taken for digest

C = mL analysis volume of digested sample

Interferences

Table 1 AQUEOUS SAMPLES (Solutions of suspensions in water—less than 1% solids)

Expected Nitrogen Concentration (mg/L)	Analysis Volume (mL)
0.5–28	10.0
2–112	5.0
11–560	2.00
45–2250	1.00
425–22500	0.50

Table 2 DRY SAMPLES

Expected Nitrogen Concentration (mg/L)	Analysis Volume (mL)
42–2200	10.0
106–5600	5.00
350–18,000	2.00
1000–56,000	1.00
4200–220,000	0.50

Table 3 OILS AND FATS

Expected Nitrogen Concentration (mg/L)	Analysis Volume (mL)
85–4500	10.0
210–11,000	5.00
2100–110,000	1.00

Sample Collection, Storage, and Preservation

Collect samples in clean glass or plastic containers. Adjust the pH to 2 or less with Sulfuric Acid (about 2 mL per liter) and cool to 4 °C (39 °F). Preserved samples can be stored up to 28 days.

Accuracy Check

Kjeldahl Nitrogen Standard Method

This procedure checks digestion efficiency and indicates that amount of bound nitrogen that is freed during digestion. The methods and standards available to check digestion technique are found in the *Accuracy Check* section following the procedure in the *Digesdahl® Digestion Apparatus Instruction Manual*. Using the digested Kjeldahl standard, perform the above TKN analysis on the colorimeter. The TKN value should come within $\pm 3\%$ of the value of the prepared Kjeldahl standard.

Standard Solution Method (to check calibration accuracy only)

1. Add one drop of TKN Indicator to each 25-mL graduated mixing cylinder.
2. Fill one cylinder to the 20-mL mark with deionized water. Fill the other cylinder to the 20-mL mark with a 1.0-mg/L $\text{NH}_3\text{-N}$ solution.
3. Add 3 drops of Mineral Stabilizer to each cylinder. Invert several times to mix.
4. Add 3 drops of Polyvinyl Alcohol Dispersing agent to each cylinder.
5. Perform the TKN procedure as described in step 12 to step 18. The display should show 26–27 mg/L TKN.

Summary of Method

The term *Total Kjeldahl Nitrogen* refers to the combination of ammonia and organic nitrogen. However, only the organic nitrogen compounds appearing as organically bound nitrogen in the trinegative state are determined in this test. Nitrogen in this form is converted into ammonium salts by the action of sulfuric acid and hydrogen peroxide. The ammonia is then analyzed by a modified Nessler method test. Test results are measured at 460 nm.

Nitrogen, Total Kjeldahl (1 to 150 mg/L)

Consumables and Replacement Items

Required Reagents

Description	Quantity/Test	Unit	Cat. No.
Nitrogen Reagent Set, 0–150 mg/L, Nessler's Method, includes:	—	250 tests	24953-00
Hydrogen Peroxide, 50%	20 mL	490 mL	21196-49
Mineral Stabilizer	6 drops	50 mL SCDB	23766-26
Nessler's Reagent	2 mL	500 mL	21194-49
Polyvinyl Alcohol Dispersing Agent	6 drops	50 mL SCDB	23765-26
Potassium Hydroxide Standard Solution, 1.0 N	varies	50 mL SCDB	23144-26
Potassium Hydroxide Standard Solution, 8.0 N	varies	100 mL MDB	282-32H
Sulfuric Acid, ACS, concentrated	6 mL	500 mL	979-49
TKN Indicator Solution	2 drops	50 mL SCDB	22519-26

Required Apparatus

Description	Quantity/Test	Unit	Cat. No.
Boiling Chips, silicon carbide	2–3	500 g	20557-34
Cots, finger	2	2/pkg	14647-02
Cylinder, graduated mixing, 25-mL	2	each	26362-40
Digesdahl® Digestion Apparatus, 115 VAC	1	each	23130-20
OR			
Digesdahl® Digestion Apparatus, 220 VAC	1	each	23130-21
Pipet, TenSette®, 0.1–1.0 mL	1	each	19700-01
Pipet Tips, for TenSette Pipet 19700-01	2	50/pkg	21856-96
Safety Shield	1	each	50030-00
Sample Cells, 1-inch square, 10 mL, matched pair	2	2/pkg	24954-02

Recommended Standards and Apparatus

Description	Unit	Cat. No.
Nitrogen, Primary Standard Set for TKN	each	22778-00
Nitrogen Standard Solution, 1-mg/L NH ₃ -N	500 mL	1891-49
Nitrogen Standard Solution, Voluette® Ampule, 150-mg/L NH ₃ -N, 10-mL	16/pkg	21284-10
Wastewater Influent Inorganics Standard for NH ₃ -N, NO ₃ -N, PO ₄ , COD, SO ₄ , TOC	500 mL	28331-49

Optional Reagents and Apparatus

Description	Unit	Cat. No.
Pour-Thru Cell Kit	each	59404-00
Sodium Thiosulfate, Pentahydrate	—	460-01



FOR TECHNICAL ASSISTANCE, PRICE INFORMATION AND ORDERING:
In the U.S.A. – Call toll-free 800-227-4224
Outside the U.S.A. – Contact the HACH office or distributor serving you.
On the Worldwide Web – www.hach.com; E-mail – techhelp@hach.com

HACH COMPANY
WORLD HEADQUARTERS
Telephone: (970) 669-3050
FAX: (970) 669-2932

Organic Carbon, Total

Method 10129

Direct Method¹

LR (0.3 to 20.0 mg/L C)

Scope and Application: For water, drinking water, and wastewater

¹ U.S. Patent 6,368,870



Test Preparation

Before starting the test:

Important Note: Install the light shield in Cell Compartment #2 before performing this test.

A reagent blank is required for each series of samples.

To test for higher ranges of TOC use Method 100173 or method 10128.

Collect the following items:

Quantity

Total Organic Carbon Direct Method Low Range Test 'N Tube™ Reagent Set	1
Cylinder, graduated, 10-mL	1
DRB200 Reactor	1
Light Shield	1
pH Paper	1
Flask, Erlenmeyer, 50-mL	1
Magnetic Stirrer	1
Pipet, TenSette®, 0.1 to 1.0 mL plus tips	1
Pipet, TenSette, 1.0 to 10.0 mL plus tips	1
Stir Bar, magnetic	1
Test Tube Rack	1-3
Water, organic-free	3.0 mL
Wipes, disposable, Kimwipes®	1

Note: Reorder information for consumables and replacement items is on page 6.

Direct Method

Method 10129

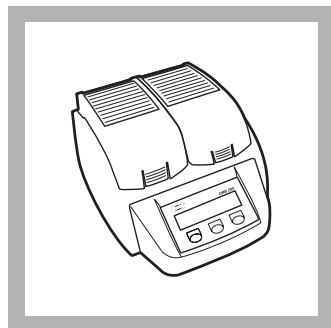

1. Turn on the DRB 200 reactor. Select the TOC program.

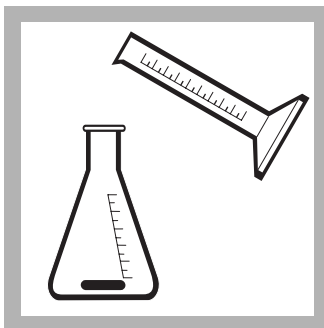

2. Use a graduated cylinder to add 10 mL of sample to a 50-mL Erlenmeyer flask that contains a stir bar.



3. Add 0.4 mL of Buffer Solution, pH 2.0. Use pH paper to make sure the sample pH is 2.

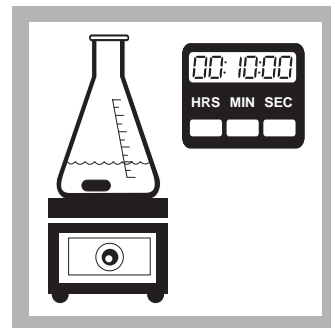

4. Place the flask on a stir plate and stir at a moderate speed for 10 minutes.

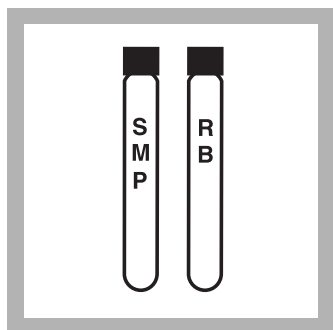

5. Label two Low Range Acid Digestion vials *sample* and *reagent blank*.

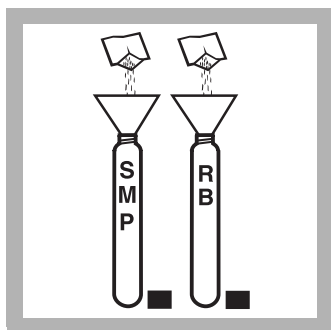

6. Use a funnel to add the contents of one TOC Persulfate Powder Pillow to each Acid Digestion vial (colorless liquid).

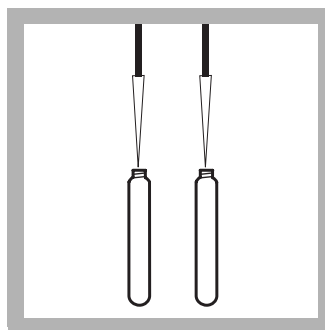

7. Use a TenSette® Pipet to add 3.0 mL of organic-free water to the reagent blank vial and 3.0 mL of prepared sample to the sample vial. Swirl to mix.



8. Rinse two blue Low Range Indicator Ampules with deionized water and wipe them with a soft, lint-free wipe.

Do not touch the ampules sides after wiping. Pick them up by the top.

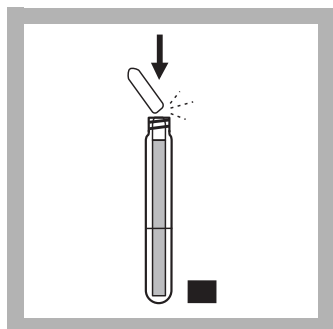

9. Lower one unopened ampule into each Acid Digestion vial. When the score mark on the ampule is level with the top of the Acid Digestion vial, snap the top off the ampule and allow it to drop into the Acid Digestion vial.

Do not invert or tilt the vial after inserting the ampule.

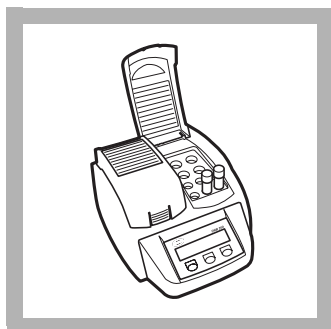

10. Cap the vial assemblies tightly and insert them in the COD reactor for 2 hours at 103–105 °C.

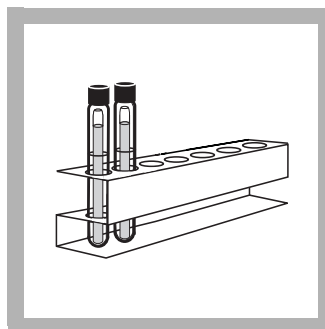

11. Carefully remove the vial assemblies from the reactor. Place them in a test tube rack.

Allow the vials to cool for one hour for accurate results.

The liquid in the reagent blank vial should be dark blue.

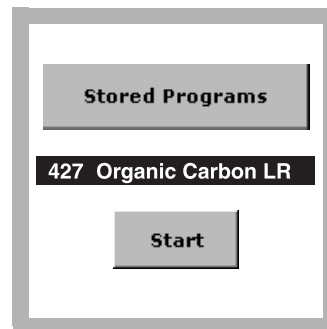

12. Select the test.

Install the Light Shield in Cell Compartment #2.

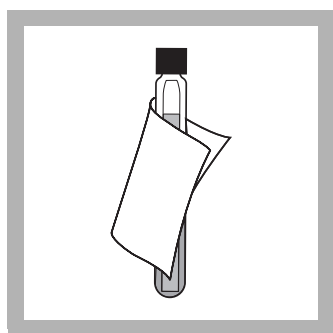

13. Wipe the reagent blank with a damp towel, followed by a dry one, to remove fingerprints or other marks.



14. Insert the reagent blank vial assembly in the 16-mm round cell holder.

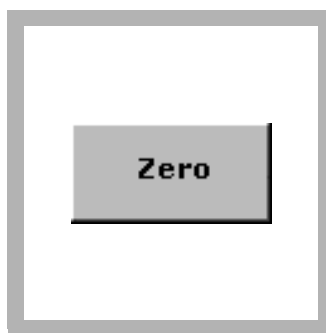

15. Press **ZERO**.
The display will show:
0.0 mg/L C.

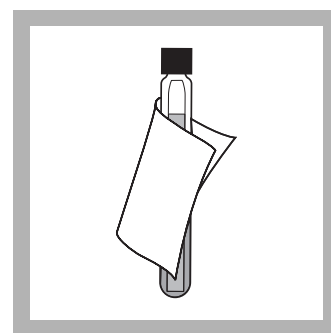

16. Wipe the sample vial assembly with a damp towel, followed by a dry one, to remove fingerprints or other marks.



17. Insert the sample vial assembly in the 16-mm round cell holder.

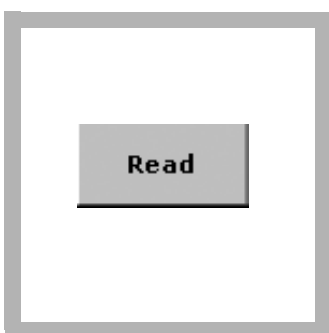

18. Press **READ**.
Results are in mg/L C.

Interferences

The following have been tested for interference and found not to interfere up to the indicated levels:

Table 1 Interfering Substances and Levels

Substance	Maximum Level Tested
Aluminum	10 mg/L
Ammonia Nitrogen	1000 mg/L as N
ASTM Wastewater	No effect
Bromide	500 mg/L Br
Bromine	25 mg/L Br ₂
Calcium	2000 mg/L as CaCO ₃
Chloride	500 mg/L
Chlorine	10 mg/L Cl ₂
Chlorine Dioxide	6 mg/L ClO ₂
Copper	10 mg/L
Cyanide	10 mg/L CN
Iodide	50 mg/L

Table 1 Interfering Substances and Levels (continued)

Substance	Maximum Level Tested
Iron (II)	10 mg/L
Iron (III)	10 mg/L
Magnesium	2000 mg/L as CaCO ₃
Manganese (VII)	1 mg/L
Monochloramine	14 mg/L NH ₂ Cl as Cl ₂
Nitrite	500 mg/L NO ₂ ⁻
Ozone	2 mg/L O ₃
Phosphate	3390 mg/L PO ₄ ³⁻
Silica	100 mg/L SiO ₂
Sulfate	5000 mg/L SO ₄ ²⁻
Sulfide	20 mg/L S ²⁻
Sulfite	50 mg/L SO ₃ ²⁻
Zinc	5 mg/L

If the sample contains greater than 600 mg/L CaCO₃ alkalinity, lower the sample pH to less than 7 before testing by adding Sulfuric Acid Solution.

Most sample turbidity is either dissolved during the digestion stage or settled during the cooling period. Sample turbidities up to 50 NTU have been tested without interference.

Sampling and Storage

Collect samples in clean glass bottles. Rinse the sample bottle several times with the sample to be collected. Fill the bottle completely full before capping. Test samples as soon as possible. Acid preservation is not recommended. Homogenize samples containing solids to assure representative samples.

Accuracy Check

Standard Additions Method (Sample Spike)

1. After reading test results, leave the sample cell (unspiked sample) in the instrument.
2. Press **OPTIONS>MORE**. Press **STANDARD ADDITIONS**. A summary of the standard additions procedure will appear.
3. Press **OK** to accept the default values for standard concentration, sample volume, and spike volumes. Press **EDIT** to change these values. After values are accepted, the unspiked sample reading will appear in the top row. See the user manual for more information.
4. Prepare a 150-g/L C standard by transferring 15.00mL of 1000-mg/L C stock solution to a 100-mL Class A volumetric flask. Dilute to volume with organic-free water. Mix.
5. Use the TenSette® Pipet to add 0.1, 0.2, and 0.3 mL of the 150-mg/L C standard to each of three Acid Digestion Vials.
6. Add the contents of one TOC Persulfate Powder Pillow to each vial.

7. Add 3.0 mL of sample to each vial. Swirl to mix. Continue the test starting at step 8 on page 2 of this procedure.
8. Analyze each sample spike as described in the procedure above, starting with the 0.1 mL sample spike. Accept each standard additions reading by pressing **READ**. Each addition should reflect approximately 100% recovery.
9. After completing the sequence, press **GRAPH** to view the best-fit line through the standard additions data points, accounting for the matrix interferences. Press **IDEAL LINE** to view the relationship between the sample spikes and the "Ideal Line" of 100% recovery.

Standard Solutions Method

1. Prepare a 1000-mg/L organic carbon stock standard by dissolving 2.1254 g dry primary standard Potassium Acid Phthalate in Organic-free Reagent Water and dilute to 1000 mL. This stock standard is stable for about 1 month at room temperature.

Alternatively, open one ampule of TOC Standard Solution, 1000 mg/L C. Perform the TOC procedure as described above.

2. Prepare a 10.0-mg/L C standard by transferring 10.00 mL of the stock standard to a 1000-mL Class A volumetric flask. Dilute to volume using Organic-Free Reagent Water. Stopper and mix thoroughly. Prepare this standard fresh daily.
3. To adjust the calibration curve using the reading obtained with the standard solution, press **OPTIONS>MORE** on the current program menu. Press **STANDARD ADJUST**.
4. Press **ON**. Press **ADJUST** to accept the displayed concentration. If an alternate concentration is used, press the number in the box to enter the actual concentration, then press **OK**. Press **ADJUST**.

Summary of Method

The total organic carbon (TOC) is determined by first sparging the sample under slightly acidic conditions to remove the inorganic carbon. In the outside vial, organic carbon in the sample is digested by persulfate and acid to form carbon dioxide. During digestion, the carbon dioxide diffuses into a pH indicator reagent in the inner ampule. The adsorption of carbon dioxide into the indicator forms carbonic acid. Carbonic acid changes the pH of the indicator solution which, in turn, changes the color. The amount of color change is related to the original amount of carbon present in the sample. Test results are measured at 598 and 430 nm.

Consumables and Replacement Items

Required Reagents

Description	Quantity/Test	Unit	Cat. No.
Reagent Set, Total Organic Carbon Direct Method Low Range Test 'N Tube™, includes:	—	50 vials	27603-45
Acid Digestion Solution Vials, High Range TOC ¹	1	50/pkg	—
Buffer Solution, Sulfate	0.4 mL	25 mL	452-33
Funnel, micro	1	each	25843-35
Indicator Ampule, Low Range TOC ¹	1	10/pkg	—
TOC Persulfate Powder Pillows ¹	1	50/pkg	—
pH Paper	1	5/pkg	391-33
Water, Organic-free	3.0 mL	500 mL	26415-49

¹ Not sold separately.

Required Apparatus

Description	Quantity/Test	Unit	Cat. No.
Cylinder, graduated, 10-mL	1	each	508-38
DRB200 Reactor, 110 V, 15 x 16 mm	1	each	LTV082.53.40001
DRB200 Reactor, 220 V, 15 x 16 mm	1	each	LTV082.52.40001
Flask, Erlenmeyer, 50-mL	1	each	505-41
Light Shield	1	each	LZV646
Magnetic Stirrer	1	each	28812-00
Pipet, TenSette®, 0.1 to 1.0 mL	1	each	19700-01
Pipet Tips, for TenSette Pipet 19700-01	2	50/pkg	21856-96
Pipet, TenSette®, 1.0 to 10.0 mL	1	each	19700-10
Pipet Tips, for TenSette Pipet 19700-10	2	50/pkg	21997-96
Stir Bar, magnetic	1	each	45315-00
Test Tube Rack	1–3	each	18641-00
Wipes, Disposable, Kimwipes®	1	280/pkg	20970-00

Recommended Standards

Description	Unit	Cat. No.
Potassium Acid Phthalate	500 g	315-34
TOC Standard Solution (KHP Standard, 1000-mg/L C)	5/pkg	27915-05

Optional Reagents

Description	Cat. No.
Sulfuric Acid Solution	2449-32



FOR TECHNICAL ASSISTANCE, PRICE INFORMATION AND ORDERING:
 In the U.S.A. – Call toll-free 800-227-4224
 Outside the U.S.A. – Contact the HACH office or distributor serving you.
 On the Worldwide Web – www.hach.com; E-mail – techhelp@hach.com

HACH COMPANY
 WORLD HEADQUARTERS
 Telephone: (970) 669-3050
 FAX: (970) 669-2932

Organic Carbon, Total

Method 10173

Direct Method¹
MR (15 to 150 mg/L C)

Scope and Application: For wastewater and industrial waters

¹ U.S. Patent 6,368,870



Test Preparation

Before starting the test:

Important Note: Install the light shield in Cell Compartment #2 before performing this test.

A reagent blank is required for each series of samples.

To test for TOC levels below 15 mg/L C, use Method 10129; to test for TOC levels above 150 mg/L C, use Method 10128.

Collect the following items:

Quantity

Total Organic Carbon Direct Method Mid Range Test 'N Tube™ Reagent Set	1
Cylinder, graduated, 10-mL	1
DRB200 Reactor	1
Flask, Erlenmeyer, 50-mL	1
Light Shield	1
Magnetic Stirrer	1
pH Paper	1
Pipet, TenSette®, 0.1 to 1.0 mL plus tips	1
Pipet, TenSette, 1.0 to 10.0 mL plus tips	1
Stir Bar, magnetic	1
Test Tube Rack	1–3
Water, organic-free	3.0 mL
Wipes, disposable, Kimwipes®	1

Note: Reorder information for consumables and replacement items is on page 6.

Direct Method

Method 10173

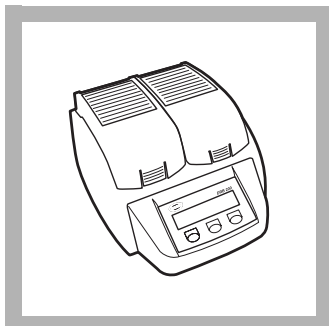

1. Turn on the DRB 200 reactor. Select the TOC program.

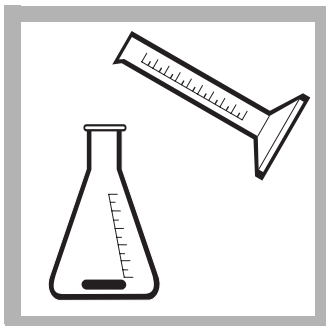

2. Use a graduated cylinder to add 10 mL of sample to a 50-mL Erlenmeyer flask that contains a stir bar.



3. Add 0.4 mL of Buffer Solution, pH 2.0. Use pH paper to make sure the sample pH is 2.

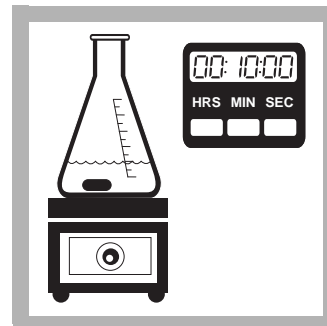

4. Place the flask on a stir plate and stir at a moderate speed for 10 minutes.

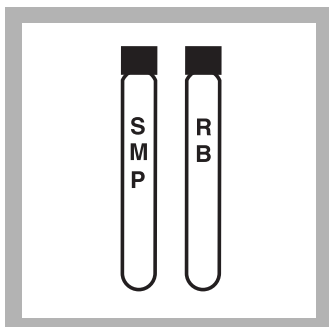

5. Label two Mid Range Acid Digestion vials *sample* and *reagent blank*.

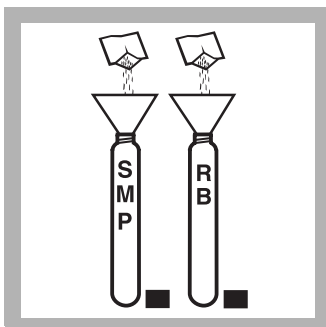

6. Use a funnel to add the contents of one TOC Persulfate Powder Pillow to each Acid Digestion vial (colorless liquid).

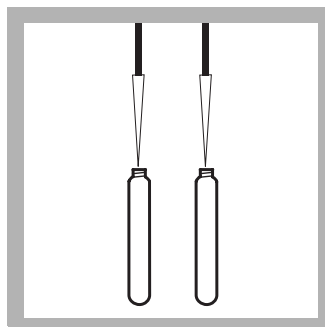

7. Use a TenSette® Pipet to add 1.0 mL of organic-free water to the reagent blank vial and 1.0 mL of prepared sample to the sample vial. Swirl to mix.



8. Rinse two blue MR/HR Indicator Ampules with deionized water and wipe them with a soft, lint-free wipe.

Do not touch the ampules sides after wiping. Pick them up by the top.

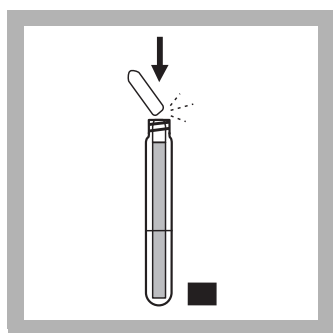

9. Lower one unopened ampule into each Acid Digestion vial. When the score mark on the ampule is level with the top of the Acid Digestion vial, snap the top off the ampule and allow it to drop into the Acid Digestion vial.

Do not invert or tilt the vial after inserting the ampule.

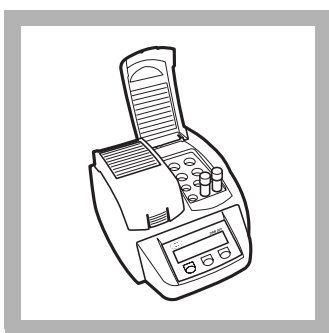

10. Cap the vial assemblies tightly and insert them in the DRB 200 reactor for 2 hours at 103–105 °C.

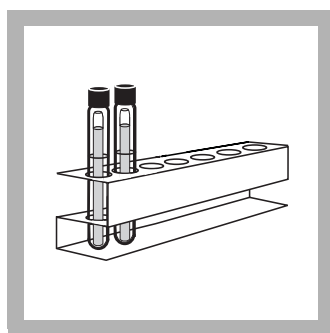

11. Carefully remove the vial assemblies from the reactor. Place them in a test tube rack.

Allow the vials to cool for one hour for accurate results.

The liquid in the blank vial should be dark blue.

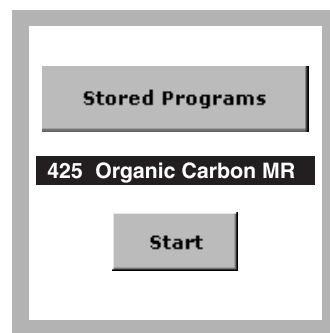

12. Select the test.
Install the Light Shield in Cell Compartment #2.

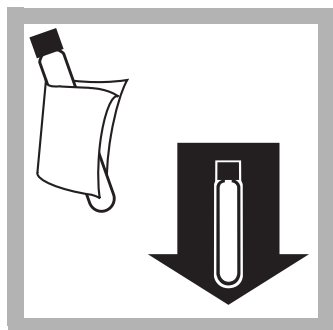

13. Wipe the reagent blank vial assembly and insert it into the 16-mm round cell holder.

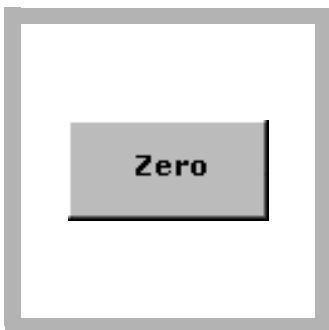

14. Press **ZERO**.
The display will show:
0 mg/L C

then Underrange until the sample is read.



15. Wipe the reagent vial assembly and insert it into the 16-mm round cell holder.

Results are in mg/L C.

The display will show Underrange when the mg/L C value is below the lower limit of the method.

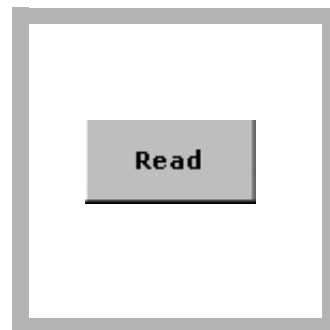

16. Press **READ**.
Results are in mg/L C.

Interferences

The following have been tested for interference and found not to interfere up to the indicated levels:

Table 1 Interfering Substances and Levels

Substance	Maximum Level Tested
Aluminum	10 mg/L

Table 1 Interfering Substances and Levels (continued)

Substance	Maximum Level Tested
Ammonia Nitrogen	1000 mg/L as N
ASTM Wastewater	No effect
Bromide	500 mg/L Br
Bromine	25 mg/L Br ₂
Calcium	2000 mg/L as CaCO ₃
Chloride	1500 mg/L
Chlorine	10 mg/L Cl ₂
Chlorine Dioxide	6 mg/L ClO ₂
Copper	10 mg/L
Cyanide	10 mg/L CN
Iodide	50 mg/L
Iron (II)	10 mg/L
Iron (III)	10 mg/L
Magnesium	2000 mg/L as CaCO ₃
Manganese (VII)	1 mg/L
Monochloramine	14 mg/L NH ₂ Cl as Cl ₂
Nitrite	500 mg/L NO ₂ ⁻
Ozone	2 mg/L O ₃
Phosphate	3390 mg/L PO ₄ ³⁻
Silica	100 mg/L SiO ₂
Sulfate	5000 mg/L SO ₄ ²⁻
Sulfide	20 mg/L S ²⁻
Sulfite	50 mg/L SO ₃ ²⁻
Zinc	5 mg/L

If the sample contains greater than 1000 mg/L CaCO₃ alkalinity, lower the sample pH to less than 7 before testing by adding Sulfuric Acid Solution*.

Most sample turbidity is either dissolved during the digestion stage or settled during the cooling period. Sample turbidities up to 50 NTU have been tested without interference.

Sampling and Storage

Collect samples in clean glass bottles. Rinse the sample bottle several times with the sample to be collected. Fill the bottle completely full before capping. Test samples as soon as possible. Acid preservation is not recommended. Homogenize samples containing solids to assure representative samples.

Accuracy Check

Standard Additions Method (Sample Spike)

1. After reading test results, leave the sample cell (unspiked sample) in the instrument.

* See [Optional Reagents on page 6](#).

2. Press **OPTIONS>MORE**. Press **STANDARD ADDITIONS**. A summary of the standard additions procedure will appear.
3. Press **OK** to accept the default values for standard concentration, sample volume, and spike volumes. Press **EDIT** to change these values. After values are accepted, the unspiked sample reading will appear in the top row. See the user manual for more information.
4. Prepare a 300-mg/L C standard by transferring 15.00mL of a 1000-mg/L organic carbon to a 50 mL Class A volumetric flask. Dilute to volume using Organic-free Reagent Water. Stopper and mix thoroughly.
5. Use the TenSette® Pipet to add 0.1, 0.2, and 0.3 mL of the 300-mg/L C standard to each of three Acid digestion vials.
6. Add the contents of one TOC Persulfate Powder Pillow to each vial.
7. Add 1.0 mL sample to each vial. Swirl to mix. Proceed with the procedure starting at step 8 on page 2.
8. Analyze each sample spike as described in the procedure above, starting with the 0.1 mL sample spike. Accept each standard additions reading by pressing **READ**. Each addition should reflect approximately 100% recovery.
9. After completing the sequence, press **GRAPH** to view the best-fit line through the standard additions data points, accounting for the matrix interferences. Press **IDEAL LINE** to view the relationship between the sample spikes and the "Ideal Line" of 100% recovery.

Standard Solutions Method

1. Prepare a 1000-mg/L organic carbon stock standard by dissolving 2.1254 g dry primary standard Potassium Acid Phthalate in Organic-Free Reagent Water and dilute to 1000 mL. This stock standard is stable for about 1 month at room temperature.

Alternatively, open one ampule of TOC Standard Solution, 1000 mg/L C. Perform the TOC procedure as described above.
2. Prepare a 100-mg/L C standard by transferring 5.00 mL of the stock standard to a 50-mL Class A volumetric flask. Dilute to volume using Organic-free Reagent Water. Stopper and mix thoroughly. Prepare this standard fresh daily.
3. To adjust the calibration curve using the reading obtained with the standard solution, press **OPTIONS>MORE** on the current program menu. Press **STANDARD ADJUST**.
4. Press **ON**. Press **ADJUST** to accept the displayed concentration. If an alternate concentration is used, press the number in the box to enter the actual concentration, then press **OK**. Press **ADJUST**.

Summary of Method

The total organic carbon (TOC) is determined by first sparging the sample under slightly acidic conditions to remove the inorganic carbon. In the outside vial, organic carbon in the sample is digested by persulfate and acid to form carbon dioxide. During digestion, the carbon dioxide diffuses into a pH indicator reagent in the inner ampule. The adsorption of carbon dioxide into the indicator forms carbonic acid. Carbonic acid changes the pH of the indicator solution

Organic Carbon, Total MR (15 to 150 mg/L C)

which, in turn, changes the color. The amount of color change is related to the original amount of carbon present in the sample. Test results are measured at 598 and 430 nm.

Consumables and Replacement Items

Required Reagents

Description	Quantity/Test	Unit	Cat. No.
Reagent Set, Total Organic Carbon Direct Method Mid Range Test 'N Tube™, includes:	—	50 vials	28159-45
Acid Digestion Solution Vials, High Range TOC ¹	1	50/pkg	—
Buffer Solution, Sulfate	0.4 mL	25 mL	452-33
Funnel, micro	1	each	25843-35
Indicator Ampoules, MR/HR TOC ¹	1	10/pkg	—
TOC Persulfate Powder Pillows ¹	1	50/pkg	—
pH Paper	1	5/pkg	391-33
Water, Organic-free	3.0 mL	500 mL	26415-49

¹ Not sold separately.

Required Apparatus

Description	Quantity/Test	Unit	Cat. No.
Cylinder, graduated, 10-mL	1	each	508-38
DRB200 Reactor, 110 V, 15 x 16 mm	1	each	LTV082.53.40001
DRB200 Reactor, 220 V, 15 x 16 mm	1	each	LTV082.52.40001
Flask, Erlenmeyer, 50-mL	1	each	505-41
Light Shield	1	each	LZV646
Magnetic Stirrer	1	each	28812-00
Pipet, TenSette®, 0.1 to 1.0 mL	1	each	19700-01
Pipet Tips, for TenSette Pipet 19700-01	2	50/pkg	21856-96
Pipet, TenSette, 1.0 to 10.0 mL	1	each	19700-10
Pipet Tips, for TenSette Pipet 19700-10	2	50/pkg	21997-96
Stir Bar, magnetic	1	each	45315-00
Test Tube Rack	1-3	each	18641-00
Wipes, disposable, Kimwipes®	1	280/pkg	20970-00

Recommended Standards

Description	Unit	Cat. No.
Potassium Acid Phthalate	500 g	315-34
TOC Standard Solution (KHP Standard, 1000-mg/L C)	5/pkg	27915-05

Optional Reagents

Description	Cat. No.
Sulfuric Acid Solution	2449-32



FOR TECHNICAL ASSISTANCE, PRICE INFORMATION AND ORDERING:
In the U.S.A. – Call toll-free 800-227-4224
Outside the U.S.A. – Contact the HACH office or distributor serving you.
On the Worldwide Web – www.hach.com; E-mail – techhelp@hach.com

HACH COMPANY
WORLD HEADQUARTERS
Telephone: (970) 669-3050
FAX: (970) 669-2932

Organic Carbon, Total

Method 10128

Direct Method¹
HR (100 to 700 mg/L C)

Scope and Application: For wastewater and industrial waters

¹ U.S. Patent 6,368,870



Test Preparation

Before starting the test:

Important Note: Install the light shield in Cell Compartment #2 before performing this test.

A reagent blank is required for each series of samples.

To test for TOC levels below 100 mg/L C, use Method 10173.

Collect the following items:

Quantity

Total Organic Carbon Direct Method High Range Test 'N Tube™ Reagent Set	1
Cylinder, graduated, 10-mL	1
DRB200 Reactor	1
Flask, Erlenmeyer, 50-mL	1
Light Shield	1
Magnetic Stirrer	1
Pipet, TenSette®, 0.1 to 1.0 mL plus tips	1
Pipet, TenSette, 1.0 to 10.0 mL plus tips	1
Stir Bar, magnetic	1
Test Tube Rack	1–3
Water, organic-free	3.0 mL
Wipes, disposable, Kimwipes®	1

Note: Reorder information for consumables and replacement items is on page 6.

Direct Method

Method 10128

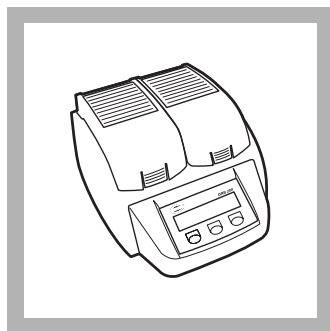

1. Turn on the DRB200 Reactor. Select the TOC program.

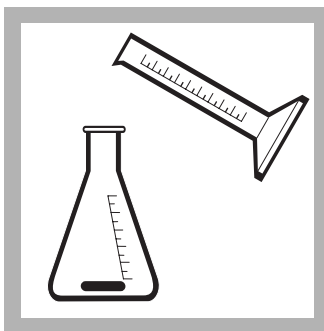

2. Use a graduated cylinder to add 10 mL of sample to a 50-mL Erlenmeyer flask that contains a stir bar.

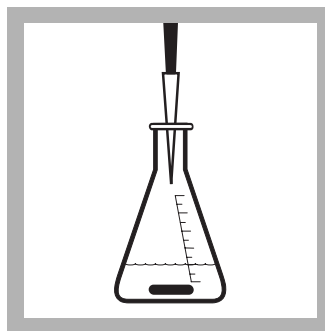

3. Add 0.4 mL of Buffer Solution, pH 2.0. Use pH paper to make sure the sample pH is 2.

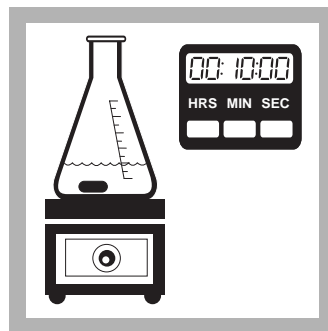

4. Place the flask on a stir plate and stir at a moderate speed for 10 minutes.

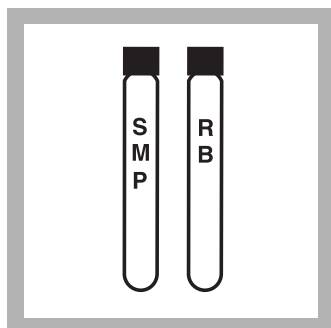

5. Label two High Range Acid Digestion vials *sample* and *reagent blank*.

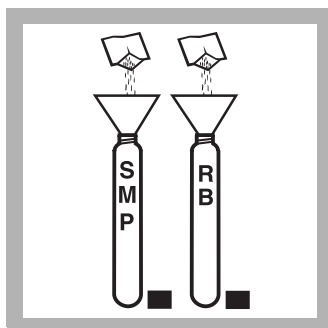

6. Use a funnel to add the contents of one TOC Persulfate Powder Pillow to each Acid Digestion vial (colorless liquid).

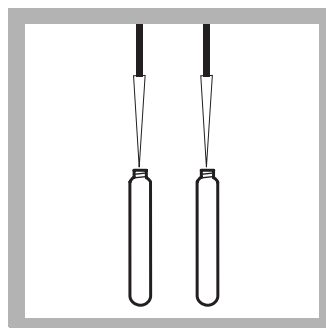

7. Use a TenSette® Pipet to add 0.3 mL of organic-free water to the reagent blank vial and 0.3 mL of prepared sample to the sample vial. Swirl to mix.



8. Rinse two blue MR/HR Indicator Ampules with deionized water and wipe them with a soft, lint-free wipe.

Do not touch the ampules sides after wiping. Pick them up by the top.

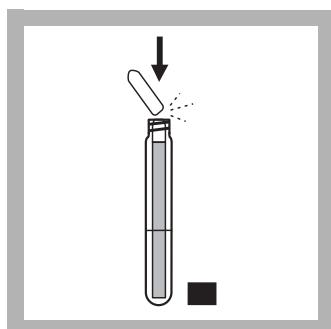

9. Lower one unopened ampule into each Acid Digestion vial. When the score mark on the ampule is level with the top of the Acid Digestion vial, snap the top off the ampule and allow it to drop into the Acid Digestion vial.

Do not invert or tilt the vial after inserting the ampule.

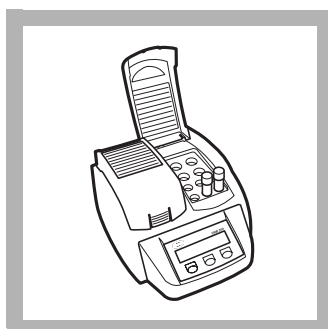

10. Cap the vial assemblies tightly and insert them in the DRB 200 reactor for 2 hours at 103–105 °C.

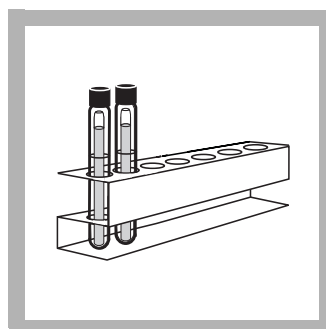

11. Carefully remove the vial assemblies from the reactor. Insert them in a test tube rack.

Allow the vials to cool for one hour for accurate results.

The liquid in the reagent blank vial should be dark blue.

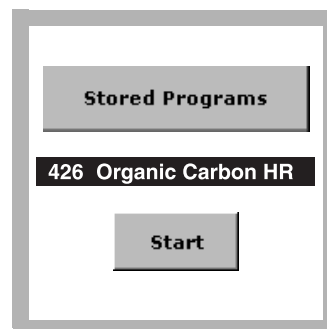

12. Select the test.

Install the Light Shield in Cell Compartment #2.

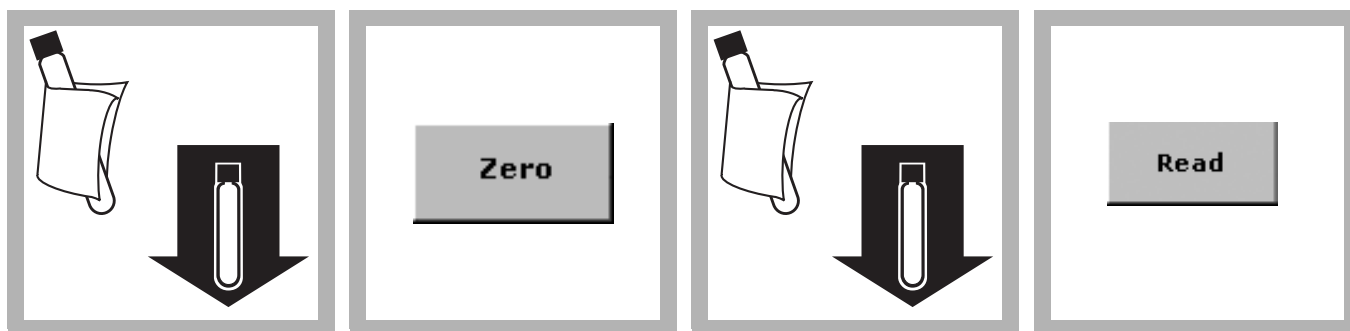

13. Wipe the reagent blank vial assembly and insert it into the 16-mm round cell holder.

14. Press **ZERO**.

The display will show:
0 mg/L C.

“Underrange” will be displayed until the sample is read.

15. Wipe the reagent vial assembly and insert it into the 16-mm round cell holder.

16. Press **READ**.

Results are in mg/L C.

The display will show Underrange when the mg/L C value is below the lower limit of the method.

Interferences

The following have been tested for interference and found not to interfere up to the indicated levels:

Table 1 Interfering Substances and Levels

Substance	Maximum Level Tested
Aluminum	10 mg/L
Ammonia Nitrogen	1000 mg/L as N
ASTM Wastewater	No effect
Bromide	500 mg/L Br
Bromine	25 mg/L Br ₂
Calcium	2000 mg/L as CaCO ₃
Chloride	5000 mg/L
Chlorine	10 mg/L Cl ₂
Chlorine Dioxide	6 mg/L ClO ₂
Copper	10 mg/L
Cyanide	10 mg/L CN
Iodide	50 mg/L
Iron (II)	10 mg/L
Iron (III)	10 mg/L
Magnesium	2000 mg/L as CaCO ₃
Manganese (VII)	1 mg/L
Monochloramine	14 mg/L NH ₂ Cl as Cl ₂
Nitrite	500 mg/L NO ₂ ⁻
Ozone	2 mg/L O ₃
Phosphate	3390 mg/L PO ₄ ³⁻
Silica	100 mg/L SiO ₂
Sulfate	5000 mg/L SO ₄ ²⁻

Table 1 Interfering Substances and Levels (continued)

Substance	Maximum Level Tested
Sulfide	20 mg/L S ²⁻
Sulfite	50 mg/L SO ₃ ²⁻
Zinc	5 mg/L

If the sample contains greater than 1000 mg/L CaCO₃ alkalinity, lower the sample pH to less than 7 before testing by adding Sulfuric Acid Solution*.

Most sample turbidity is either dissolved during the digestion stage or settled during the cooling period. Sample turbidities up to 900 NTU have been tested without interference.

Sampling and Storage

Collect samples in clean glass bottles. Rinse the sample bottle several times with the sample to be collected. Fill the bottle completely full before capping. Test samples as soon as possible. Acid preservation is not recommended. Homogenize samples containing solids to assure representative samples.

Accuracy Check

Standard Additions Method (Sample Spike)

1. After reading test results, leave the sample cell (unspiked sample) in the instrument.
2. Press **OPTIONS>MORE**. Press **STANDARD ADDITIONS**. A summary of the standard additions procedure will appear.
3. Press **OK** to accept the default values for standard concentration, sample volume, and spike volumes. Press **EDIT** to change these values. After values are accepted, the unspiked sample reading will appear in the top row. See the user manual for more information.
4. Prepare a 300-mg/L C standard as described in Standard Solutions Method, below.
5. Use the TenSette pipet to add 0.1, 0.2, and 0.3 mL of the 300-mg/L C standard to each of three Acid Digestion vials.
6. Add the contents of one TOC Persulfate powder pillow to each vial.
7. Add 0.3 mL sample to each vial. Swirl to mix. Proceed with the procedure starting at step 8 on page 2.
8. Analyze each sample spike as described in the procedure above, starting with the 0.1 mL sample spike. Accept each standard additions reading by pressing **READ**. Each addition should reflect approximately 100% recovery.
9. After completing the sequence, press **GRAPH** to view the best-fit line through the standard additions data points, accounting for the matrix interferences. Press **IDEAL LINE** to view the relationship between the sample spikes and the "Ideal Line" of 100% recovery.

* See [Optional Reagents on page 6](#).

Standard Solutions Method

1. Prepare a 1000-mg/L organic carbon stock standard by dissolving 2.1254 g dry primary standard Potassium Acid Phthalate in Organic-Free Reagent Water and dilute to 1000 mL. This stock standard is stable for about 1 month at room temperature.

Alternatively, open one ampule of TOC Standard Solution, 1000 mg/L C*.

2. Prepare a 300-mg/L C standard by transferring 15.00 mL of the stock standard to a 50-mL Class A volumetric flask. Dilute to volume using Organic-Free Reagent Water. Stopper and mix thoroughly. Prepare this standard fresh daily. Perform the TOC procedure as described above.
3. To adjust the calibration curve using the reading obtained with the standard solution, press **OPTIONS>MORE** on the current program menu. Press **STANDARD ADJUST**.
4. Press **ON**. Press **ADJUST** to accept the displayed concentration. If an alternate concentration is used, press the number in the box to enter the actual concentration, then press **OK**. Press **ADJUST**.

Summary of Method

The total organic carbon (TOC) is determined by first sparging the sample under slightly acidic conditions to remove the inorganic carbon. In the outside vial, organic carbon in the sample is digested by persulfate and acid to form carbon dioxide. During digestion, the carbon dioxide diffuses into a pH indicator reagent in the inner ampule. The adsorption of carbon dioxide into the indicator forms carbonic acid. Carbonic acid changes the pH of the indicator solution which, in turn, changes the color. The amount of color change is related to the original amount of carbon present in the sample. Test results are measured at 598 and 430 nm.

Consumables and Replacement Items

Required Reagents

Description	Quantity/Test	Unit	Cat. No.
Total Organic Carbon Direct Method High Range Test 'N Tube™ Reagent Set, includes:	—	50 vials	27604-45
Acid Digestion Solution Vials, High Range TOC ¹	1	50/pkg	—
Buffer Solution, Sulfate	0.4 mL	25 mL	452-33
Funnel, micro	1	each	25843-35
Indicator Ampules, MR/HR TOC ¹	1	10/pkg	—
TOC Persulfate Powder Pillows ¹	1	50/pkg	—
pH Paper	1	5/pkg	391-33
Water, organic-free	3.0 mL	500 mL	26415-49

¹ Not sold separately.

Required Apparatus

Description	Quantity/Test	Unit	Cat. No.
Cylinder, graduated, 10-mL	1	each	508-38
DRB200 Reactor, 110 V, 15 x 16 mm	1	each	LTV082.53.40001
DRB200 Reactor, 220 V, 15 x 16 mm	1	each	LTV082.52.40001
Flask, Erlenmeyer, 50-mL	1	each	505-41
Light Shield	1	each	LZV646
Magnetic Stirrer	1	each	28812-00
Pipet, TenSette®, 0.1 to 1.0 mL	1	each	19700-01
Pipet Tips, for TenSette Pipet 19700-01	2	50/pkg	21856-96
Pipet, TenSette, 1.0 to 10.0 mL	1	each	19700-10
Pipet Tips, for TenSette Pipet 19700-10	2	50/pkg	21997-96
Stir Bar, magnetic	1	each	45315-00
Test Tube Rack	1-3	each	18641-00
Wipes, disposable, Kimwipes®	1	280/pkg	20970-00

Recommended Standards

Description	Units	Cat. No.
Potassium Acid Phthalate	500 g	315-34
TOC Standard Solution (KHP Standard, 1000-mg/L C)	5/pkg	27915-05

Optional Reagents

Description	Cat. No.
Sulfuric Acid Solution	2449-32



FOR TECHNICAL ASSISTANCE, PRICE INFORMATION AND ORDERING:
 In the U.S.A. – Call toll-free 800-227-4224
 Outside the U.S.A. – Contact the HACH office or distributor serving you.
 On the Worldwide Web – www.hach.com; E-mail – techhelp@hach.com

HACH COMPANY
 WORLD HEADQUARTERS
 Telephone: (970) 669-3050
 FAX: (970) 669-2932

Oxygen, Dissolved

★Method 8166

HRDO Method

AccuVac® Ampuls

HR (0.3 to 15.0 mg/L O₂)

Scope and Application: For water and wastewater



Test Preparation

Before starting the test:

Analyze samples on-site. Do not store for later analysis

Collect the following items:

Quantity

High Range Dissolved Oxygen AccuVac® Ampuls with reusable Ampul caps

1

Polypropylene Beaker, 50-mL

1

Sample Cell, 10-mL

1

Note: Reorder information for consumables and replacement items is on page 4.

AccuVac Ampul®

Method 8166

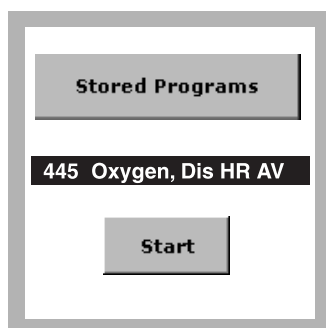

1. Select the test.

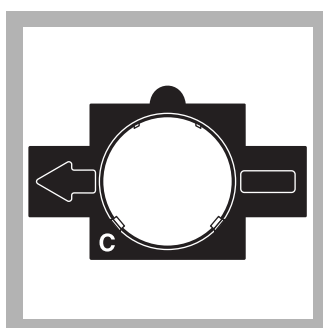

2. Insert Adapter C.

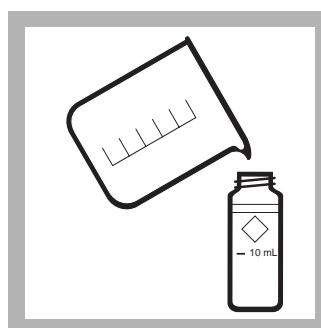

3. **Blank Preparation:**
Fill a round sample cell with 10 mL of sample.

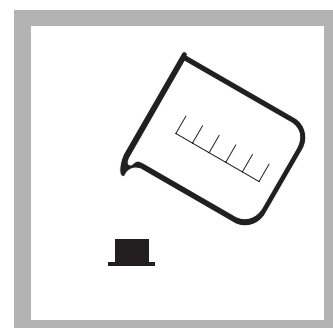

4. Fill a blue Ampul cap with sample.



5. Prepared Sample: Fill a High Range Dissolved Oxygen AccuVac Ampul with sample. Keep the tip immersed while the Ampul fills completely.

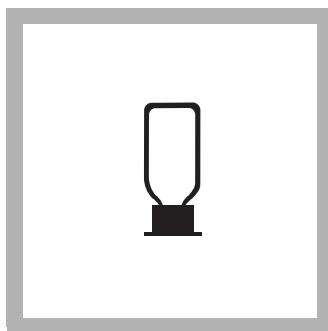

6. Hold the Ampul with the tip pointing down and immediately insert the Ampul into the Ampul cap. The cap prevents contamination from atmospheric oxygen.

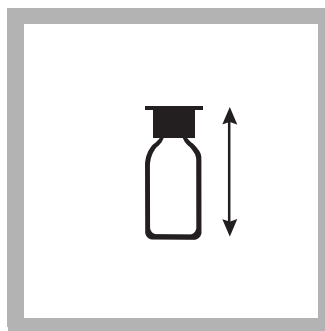

7. Shake the Ampul for 30 seconds. A small amount of undissolved reagent will not affect results.

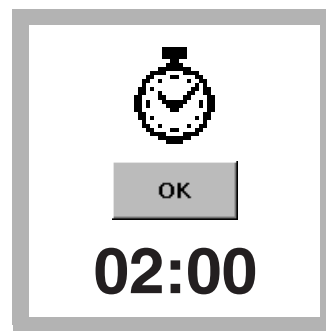

8. Press **TIMER>OK**. A two-minute reaction period will begin. This enables the oxygen that was degassed during aspiration to redissolve and react.

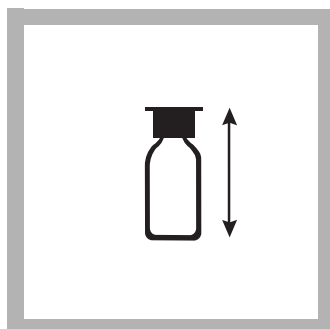

9. When the timer expires, shake the Ampul for 30 seconds.

Allow any bubbles to dissipate before proceeding.



10. Insert the blank in the cell holder.

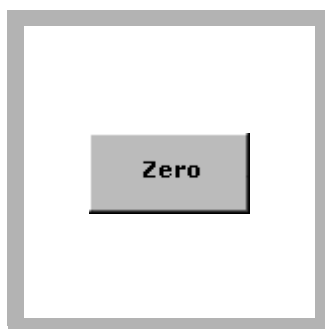

11. Press **ZERO**. The display will show: 0.0 mg/L O₂



12. Insert the prepared sample into the cell holder. Press **READ**. Results will appear in mg/L O₂.

Interferences

Table 1 Interfering Substances and Levels

Interfering Substance	Interference Levels and Treatments
Cr ³⁺	Greater than 10 mg/L
Cu ²⁺	Greater than 10 mg/L
Fe ²⁺	Greater than 10 mg/L
Mg ²⁺	Magnesium is commonly present in seawater and causes a negative interference. If the sample contains more than 50% seawater, the oxygen concentration obtained by this method will be 25% less than the true oxygen concentration. If the sample contains less than 50% seawater, the interference will be less than 5%.
Mn ²⁺	Greater than 10 mg/L
Ni ²⁺	Greater than 10 mg/L
NO ₂ ⁻	Greater than 10 mg/L

Sample Collection, Preservation, and Storage

The main consideration in sampling with the High Range Dissolved Oxygen Ampul is to prevent the sample from becoming contaminated with atmospheric oxygen between breaking open the Ampul and reading the absorbance. This is accomplished by capping the Ampul with an Ampul cap. If the Ampul is securely capped, the Ampul should be safe from contamination for several hours. The absorbance will decrease by approximately 3% during the first hour and will not change significantly afterwards.

Sampling and sample handling are important considerations in obtaining meaningful results. The dissolved oxygen content of the water being tested may change with depth, turbulence, temperature, sludge deposits, light, microbial action, mixing, travel time, and other factors. A single dissolved oxygen test rarely reflects the accurate overall condition of a body of water. Several samples taken at different times, locations, and depths are recommended for most reliable results. Samples must be tested immediately upon collection, although only a small error results if the absorbance reading is taken several hours later.

Accuracy Check

The results of this procedure may be compared with the results of a titrimetric procedure (request Lit. Code 8042), or by using any of the following dissolved oxygen meters: sens*ion*TM6 Dissolved Oxygen Meter*, HQ10 Portable LDO Dissolved Oxygen Meter*, or HQ20 Portable LDO Dissolved Oxygen/pH Meter*.

Summary of Method

The High Range Dissolved Oxygen AccuVac Ampul contains reagent vacuum-sealed in a 14-mL Ampul. When the AccuVac Ampul is opened in a sample containing dissolved oxygen, it forms a yellow color which turns purple. The purple color development is proportional to the concentration of dissolved oxygen. Test results are measured at 535 nm.

* See [Optional Reagents and Apparatus on page 4](#).

Consumables and Replacement Items

Required Reagents

Description	Quantity/Test	Unit	Cat. No.
High Range Dissolved Oxygen AccuVac® Ampuls with 2 reusable Ampul caps	1	25/pkg	25150-25

Required Apparatus

Description	Quantity/Test	Unit	Cat. No.
Adapter, 1-inch round, for AccuVac Ampuls	1	each	LZV584
Polypropylene Beaker, 50-mL	1	each	1080-41
Sample Cell, 10-mL, with cap	1	each	21228-00

Optional Reagents and Apparatus

Description	Cat. No.
HQ10 Portable LDO Dissolved Oxygen Meter	51815-00
HQ20 Portable LDO Dissolved Oxygen/pH Meter	51825-00
sens <i>ion</i> ™6 Dissolved Oxygen Meter	51850-01



FOR TECHNICAL ASSISTANCE, PRICE INFORMATION AND ORDERING:
In the U.S.A. – Call toll-free 800-227-4224
Outside the U.S.A. – Contact the HACH office or distributor serving you.
On the Worldwide Web – www.hach.com; E-mail – techhelp@hach.com

HACH COMPANY
WORLD HEADQUARTERS
Telephone: (970) 669-3050
FAX: (970) 669-2932

Oxygen, Dissolved

Method 8333

AccuVac® Ampul

Ultra High Range Method

UHR (1.0 to 40.0 mg/L O₂)

Scope and Application: For aquaculture



Test Preparation

Before starting the test:

Analyze samples on-site. Do not store for later analysis.

Collect the following items:

Quantity

High Range Dissolved Oxygen AccuVac® Ampuls, with reusable Ampul caps

1

Polypropylene Beaker, 50-mL

1

Sample Cell, 10-mL

1

Note: Reorder information for consumables and replacement items is on page 3.

AccuVac Ampul®

Method 8333

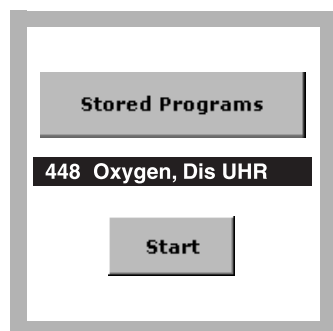

1. Select the test.

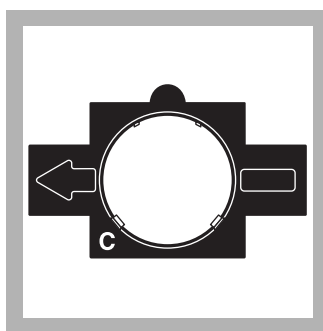

2. Insert Adapter C.

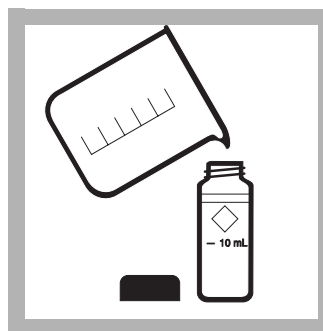

3. **Blank Preparation:**
Fill a round sample cell with 10 mL of sample.

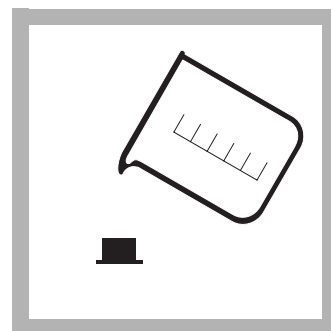

4. Fill a blue Ampul cap with sample.



5. Prepared Sample:
Fill a High Range Dissolved Oxygen AccuVac Ampul with sample. Keep the tip immersed while the Ampul fills completely.

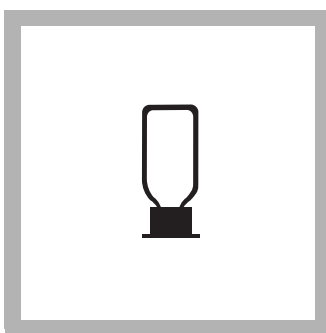

6. Hold the Ampul with the tip pointing down and immediately insert the Ampul into the Ampul cap. The cap prevents contamination from atmospheric oxygen.

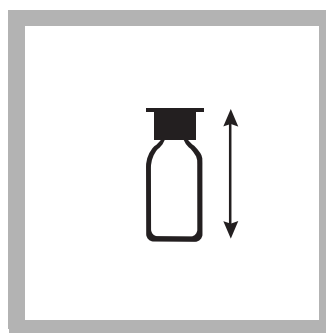

7. Shake the Ampul for 30 seconds. A small amount of undissolved reagent will not affect results.

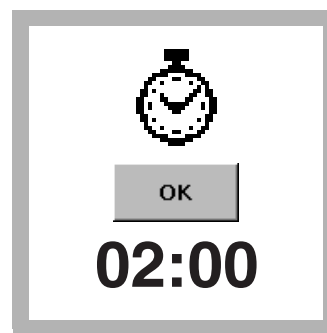

8. Touch **TIMER>OK**. A two-minute reaction period will begin. This enables the oxygen that was degassed during aspiration to redissolve and react.

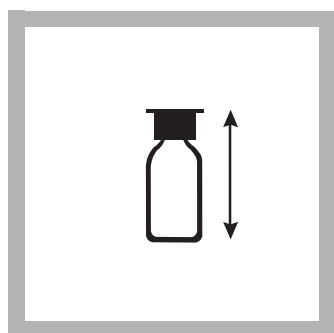

9. When the timer expires, shake the Ampul for 30 seconds. Allow any bubbles to dissipate before proceeding.



10. Insert the blank into the cell holder.

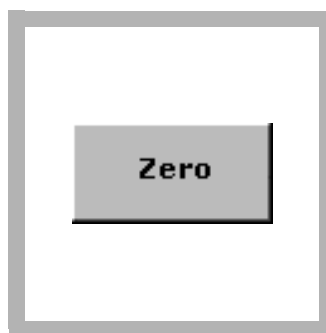

11. Press **ZERO**. The display will show: 0.0 mg/L O₂

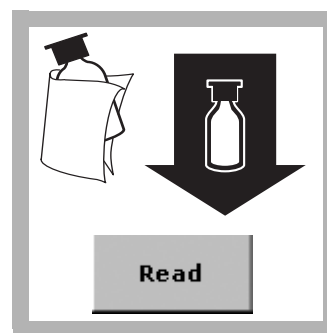

12. Insert the prepared sample into the cell holder. Press **READ**. Results are in mg/L O₂.

Interferences

Table 1 Interfering Substances and Levels

Interfering Substance	Interference Levels and Treatments
Cr ³⁺	Greater than 10 mg/L
Cu ²⁺	Greater than 10 mg/L
Fe ²⁺	Greater than 10 mg/L
Mg ²⁺	Magnesium is commonly present in seawater and interferes. If the sample contains more than 50% seawater, the oxygen concentration observed will be 25% lower than the true oxygen concentration. If the sample contains less than 50% seawater, the interference will be less than 5%.
Mn ²⁺	Greater than 10 mg/L
Ni ²⁺	Greater than 10 mg/L
NO ₂ ⁻	Greater than 10 mg/L

Sample Collection, Preservation, and Storage

The main consideration in sampling with the High Range Dissolved Oxygen AccuVac Ampul is to prevent the sample from becoming contaminated with atmospheric oxygen between breaking open the Ampul and reading the absorbance. This is accomplished by capping the Ampul with an Ampul cap. If the Ampul is securely capped, the Ampul should be safe from contamination for several hours. The absorbance will decrease by approximately 3% during the first hour and will not change significantly afterwards.

Sampling and sample handling are important considerations in obtaining meaningful results. The dissolved oxygen content of the water being tested may change with depth, turbulence, temperature, sludge deposits, light, microbial action, mixing, travel time, and other factors. A single dissolved oxygen test rarely reflects the accurate over-all condition of a body of water. Several samples taken at different times, locations, and depths are recommended for most reliable results. Samples must be tested immediately upon collection although only a small error results if the absorbance reading is taken several hours later.

Accuracy Check

The results of this procedure may be compared with the results of a titrimetric procedure (request Lit. Code 8042), or by using any of the following dissolved oxygen meters: sens*ion*[™] 6 Dissolved Oxygen Meter*, HQ10 Portable LDO Dissolved Oxygen Meter*, or HQ20 Portable LDO Dissolved Oxygen/pH Meter*.

Summary of Method

The High Range Dissolved Oxygen AccuVac Ampul contains reagent vacuum sealed in a 14-mL Ampul. When the AccuVac Ampul is broken open in a sample containing dissolved oxygen, it forms a yellow color which turns purple. The purple color development is proportional to the concentration of dissolved oxygen. Test results are measured at 680 nm.

Consumables and Replacement Items

Required Reagents

Description	Quantity/Test	Unit	Cat. No.
High Range Dissolved Oxygen AccuVac [®] Ampuls, with 2 reusable Ampul caps	1	25/pkg	25150-25

Required Apparatus (AccuVac)

Description	Quantity/Test	Unit	Cat. No.
Adapter, 1-inch round, for AccuVac Ampuls	1	each	LZV584
Polypropylene Beaker, 50-mL	1	each	1080-41
Sample Cell, 10-mL, with cap	1	each	21228-00

Optional Reagents and Apparatus

Description	Cat. No.
HQ10 Portable LDO Dissolved Oxygen Meter	51815-00
HQ20 Portable LDO Dissolved Oxygen/pH Meter	51825-00
sens <i>ion</i> [™] 6 Dissolved Oxygen Meter	51850-01

*See [Optional Reagents and Apparatus on page 3](#).



FOR TECHNICAL ASSISTANCE, PRICE INFORMATION AND ORDERING:

In the U.S.A. – Call toll-free 800-227-4224
Outside the U.S.A. – Contact the HACH office or distributor serving you.
On the Worldwide Web – www.hach.com; E-mail – techhelp@hach.com

HACH COMPANY
WORLD HEADQUARTERS
Telephone: (970) 669-3050
FAX: (970) 669-2932

Oxygen, Dissolved

Method 8316

Indigo Carmine Method

AccuVac® Ampuls

LR (6 to 800 µg/L O₂)

Scope and Application: For boiler feedwater



Test Preparation

Before starting the test:

The Ampuls will contain a small piece of wire to maintain reagent quality. The solution will be yellow.

Collect the following items:

Quantity

Low Range Dissolved Oxygen AccuVac® Ampuls

1

Polypropylene Beaker, 50 mL

1

Sample Cell, 10-mL with cap

1

Note: Reorder information for consumables and replacement items is on page 3.

AccuVac® Ampul

Method 8316

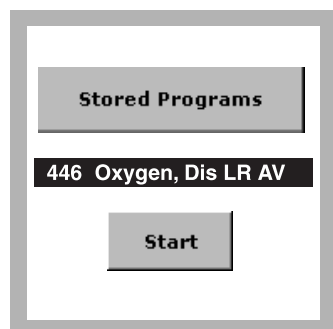

1. Select the test.

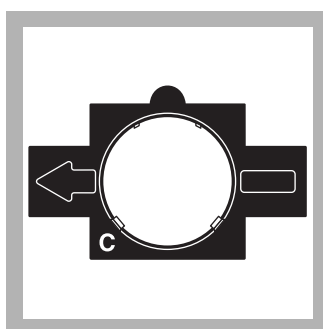

2. Insert Adapter C.

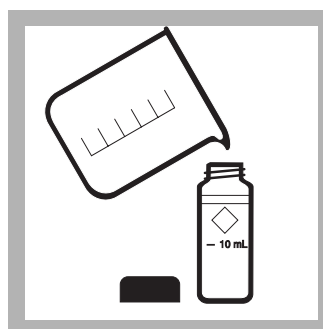

3. **Blank Preparation:**
Fill a round sample cell
with 10 mL of sample.

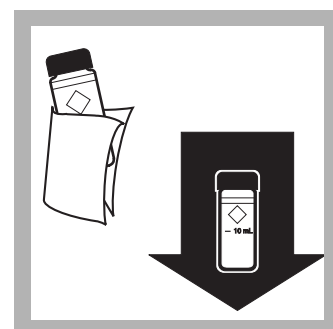

4. Insert the blank into
the cell holder.

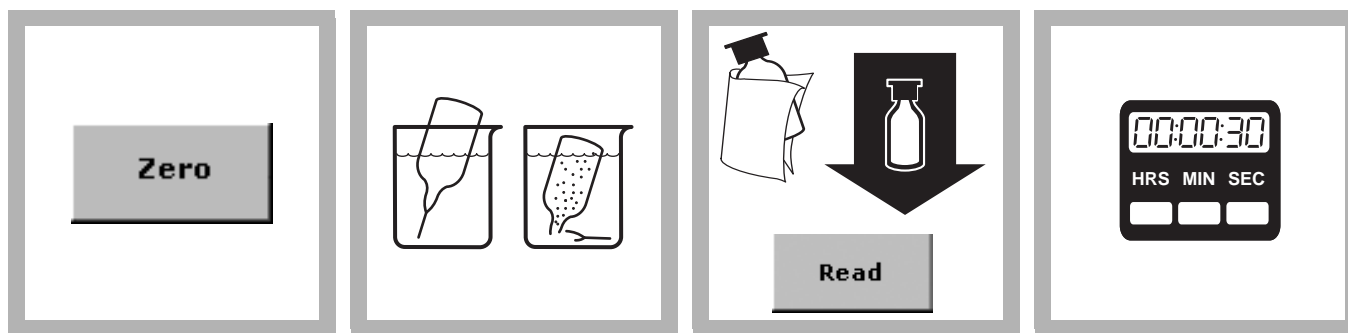

5. Press ZERO.

The display will show:
0 µg/L O₂

6. Fill a Low Range Dissolved Oxygen Ampul with sample. Keep the tip immersed while the Ampul fills completely.

7. Immediately insert the Ampul into the cell holder. Press READ. Results are in µg/L O₂.

8. Use the initial reading. The reading is stable for 30 seconds. After 30 seconds the Ampul solution will absorb oxygen from the air.

Interferences

Table 1 Interfering Substances and Levels

Interfering Substance	Interference Levels and Treatments
Hydrazine	100,000 fold excess will begin to reduce the oxidized form of the indicator solution.
Sodium hydrosulfite	Reduces the oxidized form of the indicator solution and will cause a significant interference.

Excess amounts of thioglycolate, ascorbate, ascorbate + sulfite, ascorbate + cupric sulfate, nitrite, sulfite, thiosulfate, and hydroquinone will not reduce the oxidized form of the indicator and do not cause significant interference.

Sample Collection, Preservation, and Storage

The main consideration in this procedure is to prevent contaminating the sample with atmospheric oxygen. Sampling from a stream of water that is hard plumbed to the sample source is ideal. Use a funnel to maintain a continual flow of sample and yet collect enough sample to immerse the Ampul. It is important not to introduce air in place of the sample. Rubber tubing, if used, will introduce unacceptable amounts of oxygen into the sample unless the length of tubing is minimized and the flow rate is maximized. Flush the sampling system with sample for at least 5 minutes.

Accuracy Check

The results of this procedure may be compared using one of the following portable dissolved oxygen meters: HQ10*, HQ20*, or the sens*ion*TM 6*.

The reagent blank for this test can be checked by following these steps:

1. Fill a 50-mL beaker with sample and add approximately 50 mg sodium hydrosulfite.
2. Immerse the tip of a Low Range Dissolved Oxygen AccuVac Ampul in the sample into the tip. Aspirate the sample into the Ampul.
3. Determine the dissolved oxygen concentration according to the preceding procedure. The result should be 0 ± 6 µg/L.

* See [Optional Apparatus on page 3](#).

Summary of Method

The Low Range Dissolved Oxygen AccuVac Ampul contains reagent vacuum-sealed in a 14-mL Ampul. When the AccuVac Ampul is broken open in a sample containing dissolved oxygen, the yellow solution will turn blue. The blue color development is proportional to the concentration of dissolved oxygen. Test results are measured at 610 nm.

Consumables and Replacement Items

Required Reagents

Description	Quantity/Test	Unit	Cat. No.
Low Range Dissolved Oxygen AccuVac [®] Ampuls	1	25/pkg	25010-25

Required Apparatus

Description	Quantity/Test	Unit	Cat. No.
Adapter, 1-inch round, for AccuVac Ampuls	1	each	LZV584
Beaker, Polypropylene, 50 mL	1	each	1080-41
Sample Cells, 10 mL, with cap	1	each	21228-00

Recommended Standards

Description	Unit	Cat. No.
Sodium Hydrosulfite, technical grade	500 g	294-34

Optional Apparatus

Description	Cat. No.
HQ10 Portable LDO Meter	51815-00
HQ20 Portable LDO Meter	51825-00
sens ^{ion} [™] 6	51850-01



FOR TECHNICAL ASSISTANCE, PRICE INFORMATION AND ORDERING:

In the U.S.A. – Call toll-free 800-227-4224
Outside the U.S.A. – Contact the HACH office or distributor serving you.
On the Worldwide Web – www.hach.com; E-mail – techhelp@hach.com

HACH COMPANY
WORLD HEADQUARTERS
Telephone: (970) 669-3050
FAX: (970) 669-2932

Oxygen Demand, Chemical

★ Method 8000

Reactor Digestion Method¹

TNTplus™

LR (TNT821, 3–150 COD);
HR (TNT822, 20–1500mg/L COD)

Scope and Application: For water, wastewater; digestion is required;
3–150 mg/L and 20– 1500 mg/L COD ranges are USEPA approved for wastewater analyses²

¹ Jirka, A.M.; Carter, M.J., *Analytical Chemistry*, 1975, 47(8), 1397

² *Federal Register*, April 21, 1980, 45(78), 26811-26812



Test Preparation

Before starting the test:

Important Note: Install the light shield in Cell Compartment #2 before performing this test.

Please read *Safety Advice* and *Expiration Date* on package.

Some of the chemicals and apparatus used in this procedure may be hazardous to the health and safety of the user if inappropriately handled or accidentally misused. Please read all warnings and associated MSDS sheets.

To run the optional blank for a set of samples, see [Blanks for Colorimetric Determination on page 3](#).

Spilled reagent will affect test accuracy and is hazardous to skin and other materials.

Be prepared to wash spills with running water.

Wear appropriate eye protection and clothing for adequate user protection. If contact occurs, flush the affected area with running water. Review and follow instructions carefully.

Store unused (light-sensitive) vials in a closed box.

Collect the following items:

Quantity

Blender	1
DRB200 Reactor with 13-mm wells (use adapters with 16-mm holes)	1
COD TNTplus™ vials for the appropriate concentration range	varies
Light Shield	1
Pipettor for 2.0 mL Sample	1
Pipettor Tip	1
Test Tube Rack	2

Note: Reorder information for consumables and replacement items is on page 5.

TNT Plus

Method 8000

Important Note: If the sample does not contain suspended solids, omit steps 1 and 3.

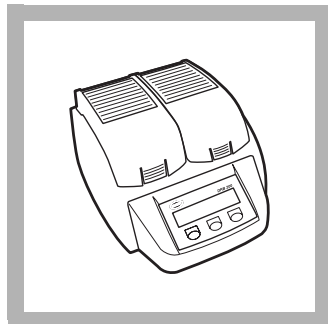

1. Turn on the DRB200 Reactor. Preheat to 150 °C.

Note: For DRB200 Reactors with 16-mm wells, insert a 16-mm to 13-mm adapter sleeve into each well **before** turning on the reactor.

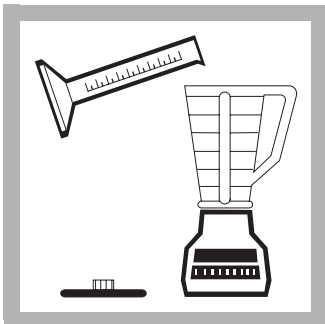

2. Homogenize 100 mL of sample for 30 seconds in a blender. For samples containing large amounts of solids, increase the homogenization time.

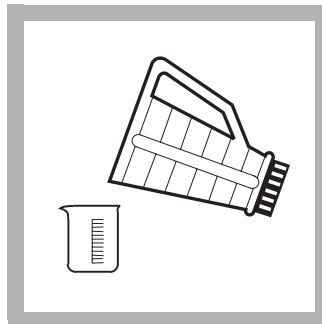

3. To help ensure that a representative portion of sample is analyzed, pour the homogenized sample into a 250-mL beaker and gently stir with a magnetic stir plate.

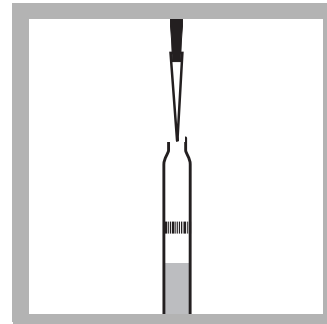

4. Carefully pipet 2.0 mL of sample into the vial. Cap and clean the outside of the vial.

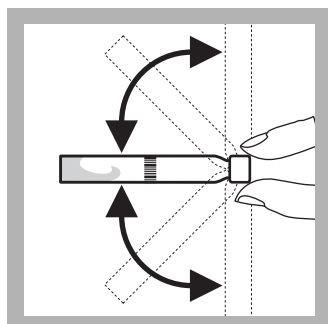

5. Hold the vial by the cap over a sink. Invert gently several times to mix. The sample vials will become very hot during mixing.

Place the vial in the preheated DRB200 Reactor. Close the protective lid

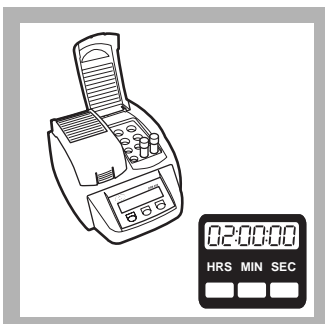

6. Heat for two hours.

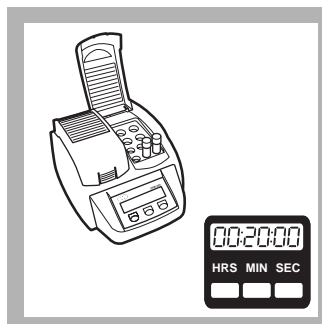

7. Turn the reactor off. Wait about 20 minutes for the vial to cool to 120 °C or less.

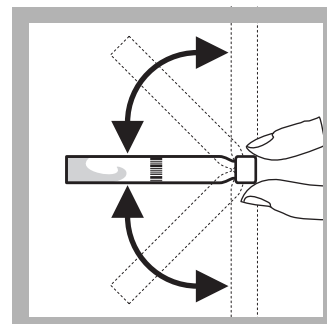

8. Invert the vial several times while still hot.

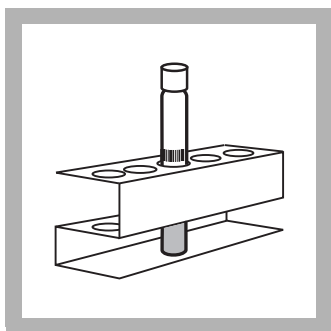

9. Place the vial into a rack to cool to room temperature.

Install the Light Shield in Cell Compartment #2.

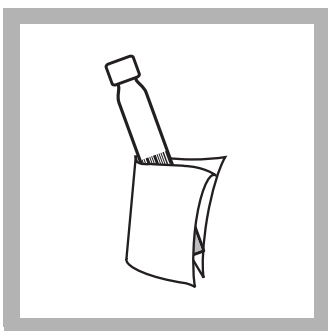

10. Thoroughly clean the outside of the vial.

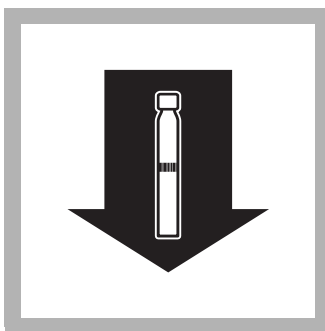

11. Insert the vial into the cell holder. Close the lid.

The instrument reads the barcode, then selects and performs the correct test.

Results are in mg/L COD.

Blanks for Colorimetric Determination

A reagent blank can be measured, and the value subtracted from the results of each test performed using the same reagent lot number. The blank may be used repeatedly for measurements using the same lot of vials. Store it in the dark, and monitor decomposition by measuring its concentration periodically.

To subtract the value of the blank from a series of measurements, measure the blank per step 11. Press **OPTIONS>MORE>REAGENT BLANK**. Select **ON**. The measured value of the blank should be displayed in the highlighted box. Press **OK** to accept this value. The reagent blank value will now be subtracted from all results until the function is turned off, or a different method is selected. Alternately, the blank can be recorded and entered at any later time by pressing the highlighted box and using the keypad to enter the value.

Interferences

Chloride is the primary interference when determining COD concentration. Each COD vial contains mercuric sulfate that will eliminate chloride interference up to 2000 mg/L Cl⁻.

Sampling and Storage

Collect samples in glass bottles. Use plastic bottles only if they are known to be free of organic contamination. Test biologically active samples as soon as possible. Homogenize samples containing solids to assure representative samples. Samples treated with sulfuric acid* to a pH of less than 2 (about 2 mL per liter) and refrigerated at 4 °C can be stored up to 28 days. Correct results for volume additions.

* See [Optional Reagents and Apparatus on page 5](#).

Accuracy Check

Standard Solution Method

1. Check the accuracy of the 3 to 150 mg/L range with a 100 mg/L standard. Prepare by dissolving 85 mg of dried (120 °C, overnight) potassium acid phthalate (KHP) in 1 liter of deionized water. Use 2 mL as the sample volume. The result should be 100 mg/L COD. Or, dilute 10 mL of 1000-mg/L COD Standard Solution to 100 mL to produce a 100-mg/L standard.
2. Check the accuracy of the 20 to 1,500 mg/L range by using either a 300 mg/L or 1000 mg/L COD Standard Solution. Use 2 mL of one of these solutions as the sample volume; the expected result will be 300 or 1000 mg/L COD respectively. Or, prepare a 500 mg/L standard by dissolving 425 mg of dried (120 °C, overnight) KHP. Dilute to 1 liter with deionized water.

Summary of Method

The mg/L COD results are defined as the mg of O₂ consumed per liter of sample under conditions of this procedure. In this procedure, the sample is heated for two hours with a strong oxidizing agent, potassium dichromate. Oxidizable organic compounds react, reducing the dichromate ion (Cr₂O₇²⁻) to green chromic ion (Cr³⁺). When the 3–150 mg/L colorimetric method is used, the amount of Cr⁶⁺ remaining is determined. When the 20–1500 mg/L colorimetric method is used, the amount of Cr³⁺ produced is determined. The COD reagent also contains silver and mercury ions. Silver is a catalyst, and mercury is used to complex chloride interferences. Test results for the 3 to 150 mg/L range are measured at 420 nm. Test results for the 20 to 1,500 mg/L COD range are measured at 620 nm.

Consumables and Replacement Items

Required Reagents

Description	Quantity/Test	Unit	Cat. No.
Select the appropriate TNTplus™ COD Digestion Reagent Vial:			
Low Range, 3 to 150 mg/L COD	1–2 vials	25/pkg	TNT821
High Range, 20 to 1500 mg/L COD	1–2 vials	25/pkg	TNT822

Required Apparatus

Description	Quantity/Test	Unit	Cat. No.
DRB200 Reactor, 115 V, 9 x 13 mm + 2 x 20 mm (mono block)	1	each	DRB200-01
DRB200 Reactor, 230 V, 9 x 13 mm + 2 x 20 mm (mono block)	1	each	DRB200-05
Light Shield	1	each	LZV646
Pipet, variable volume, 1–5 mL	1	each	27951-00
Pipet Tips, for 27951-00 pipet	1	100/pkg	27952-00
Test Tube Rack, 13-mm	1–2	each	24979-00

Recommended Standards and Apparatus

Description	Unit	Cat. No.
COD Standard Solution, 300-mg/L	200 mL	12186-29
COD Standard Solution, 1000-mg/L	200 mL	22539-29
Potassium Acid Phthalate, ACS	500 g	315-34
Oxygen Demand Standard (BOD, COD, TOC), 10-mL ampules	16/pkg	28335-10
Wastewater Influent Standard, for mixed parameters (NH ₃ -N, NO ₃ -N, PO ₄ , COD, SO ₄ , TOC)	500 mL	28331-49
Wastewater Effluent Standard, for mixed parameters (NH ₃ -N, NO ₃ -N, PO ₄ , COD, SO ₄ , TOC)	500 mL	28332-49

Optional Reagents and Apparatus

Description	Unit	Cat. No.
Beaker, 250 mL	each	500-46H
Blender, 2-speed, 120 VAC	each	26161-00
Blender, 2-speed, 240 VAC	each	26161-02
DRB200 Reactor, 115 V, 21x13 mm + 4x20 mm (dual block)	each	DRB200-02
DRB200 Reactor, 115 V, 15x13 mm + 15x13 mm (dual block)	each	DRB200-03
DRB200 Reactor, 115 V, 12x13 mm + 8x20 mm (dual block)	each	DRB200-04
DRB200 Reactor, 230 V, 21x13 mm + 4x20 mm (dual block)	each	DRB200-06
DRB200 Reactor, 230V, 15x13 mm+ 15x13 mm (dual block)	each	DRB200-07
DRB200 Reactor, 230 V, 12x13 mm + 8x20 mm (dual block)	each	DRB200-08
Stir Plate, magnetic	each	28812-00
Stir Bar, octagonal	each	20953-52
Sulfuric Acid, ACS	500 mL	979-49
TNTplus™ Reactor adapter sleeves, 16-mm to 13-mm diameter	5/pkg	28958-05



FOR TECHNICAL ASSISTANCE, PRICE INFORMATION AND ORDERING:

In the U.S.A. – Call toll-free 800-227-4224
Outside the U.S.A. – Contact the HACH office or distributor serving you.
On the Worldwide Web – www.hach.com; E-mail – techhelp@hach.com

HACH COMPANY
WORLD HEADQUARTERS
Telephone: (970) 669-3050
FAX: (970) 669-2932

Oxygen Demand, Chemical

★ Method 8000

Reactor Digestion Method¹

(0.7 to 40.0², 3 to 150, 20 to 1500 and
200 to 15,000 mg/L COD)

Scope and Application: For water, wastewater, and seawater; digestion is required; 3–150 mg/L and 20–1500 mg/L COD ranges are USEPA approved for wastewater analyses³; 200–15,000 mg/L COD range are not USEPA approved.

¹ Jirka, A.M.; Carter, M.J., *Analytical Chemistry*, 1975, 47(8), 1397

² Ultra Low Range is not available on the DR 2700.

³ *Federal Register*, April 21, 1980, 45(78), 26811-26812



Test Preparation

Before starting the test:

Important Note: Install the light shield in Cell Compartment #2 before performing this test.

Important Note: Ultra low range (0.7 to 40.0 mg/L) is not available on the DR 2700.

Some of the chemicals and apparatus used in this procedure may be hazardous to the health and safety of the user if inappropriately handled or accidentally misused. Please read all warnings and associated MSDS sheets.

Run one blank with each set of samples. Run all tests (the samples and the blank) with the same lot of vials. The lot number appears on the container label. See [Blanks for Colorimetric Determination on page 4](#).

Spilled reagent will affect test accuracy and is hazardous to skin and other materials. Be prepared to wash spills with running water

Wear appropriate eye protection and clothing for adequate user protection. If contact occurs, flush the affected area with running water. Review and follow instructions carefully.

Collect the following items:

Quantity

Beaker, 250-mL	1
Blender	1
COD Digestion Reagent vials	varies
DRB200 Reactor	1
Light Shield	1
Magnetic stirrer and stir bar	1
Opaque shipping container for storage of unused, light-sensitive reagent vials	varies
Pipet, TenSette®, 0.1 to 1.0 mL, with tips (for 200–15,000 mg/L range)	1
Pipet, volumetric, 2.00 mL	2
Pipet Filler, safety bulb	1
Test Tube Rack	2

Note: Reorder information for consumables and replacement items is on page 6.

Note: For greater accuracy, analyze a minimum of three replicates and average the results.

Digestion Procedure

Method 8000

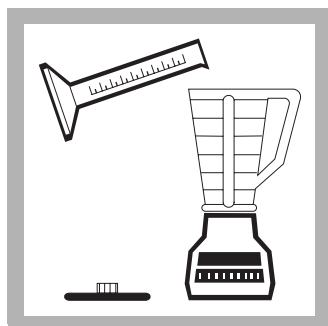

1. Homogenize 100 mL of sample for 30 seconds in a blender. For samples containing large amounts of solids, increase the homogenization time.

If the sample does not contain suspended solids, omit steps 1 and 2.

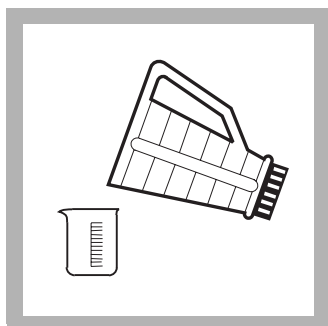

2. For the 200–15,000 mg/L range or to improve accuracy and reproducibility of the other ranges, pour the homogenized sample into a 250-mL beaker and gently stir with a magnetic stir plate.

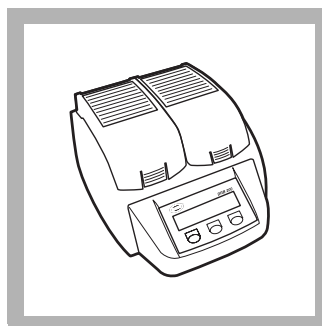

3. Turn on the DRB200 Reactor. Preheat to 150 °C.

See the DRB200 User Manual for selecting pre-programmed temperature applications.

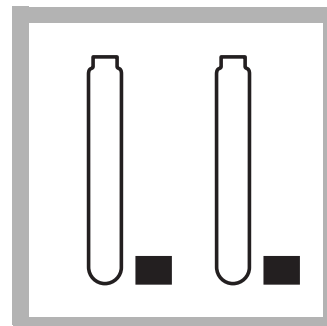

4. Remove the caps from two COD Digestion Reagent Vials. (Be sure to use vials for the appropriate range.)

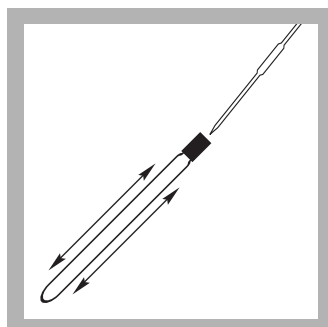

5. **Prepared Sample:** Hold one vial at a 45-degree angle. Use a clean volumetric pipet to add 2.00 mL of sample to the vial.

Use a TenSette® Pipet to add 0.20 mL for the 200–15,000 mg/L range.

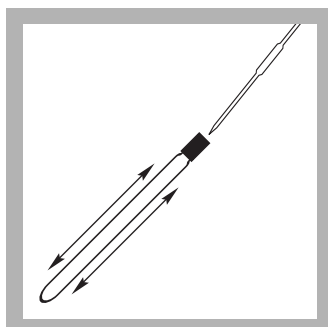

6. **Blank Preparation:** Hold a second vial at a 45-degree angle. Use a clean volumetric pipet to add 2.00 mL of deionized water to the vial.

Use a TenSette Pipet to add 0.20 mL for the 200–15,000 mg/L range.

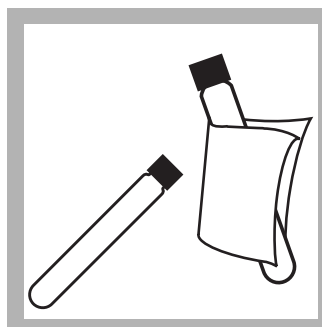

7. Cap the vials tightly. Rinse them with water and wipe with a clean paper towel.

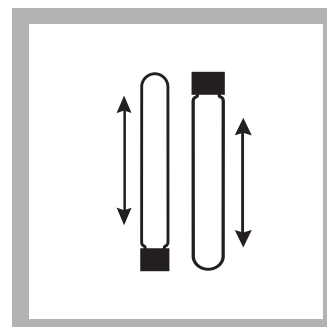

8. Hold the vials by the cap over a sink. Invert gently several times to mix. Insert the vials in the preheated DRB200 Reactor. Close the protective lid.

The sample vials will become very hot during mixing.

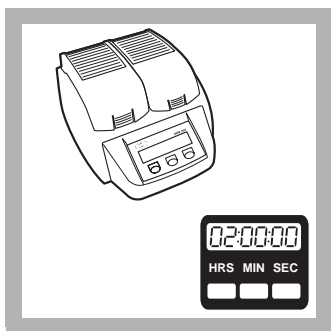

9. Heat the vials for two hours.

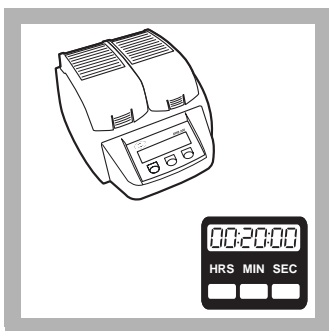

10. Turn the reactor off.
Wait about 20 minutes for the vials to cool to 120 °C or less.

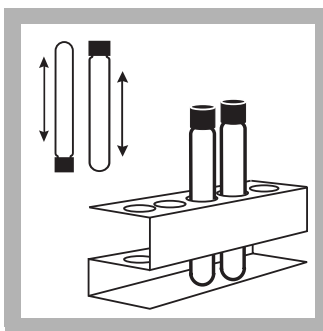

11. Invert each vial several times while still warm. Place the vials into a rack and cool to room temperature.

Proceed to [Colorimetric Determination Method 8000](#).

Colorimetric Determination

Method 8000

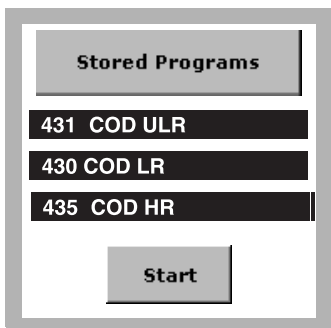

1. Select the ultra-low range (DR 2800 only), low range, or high range test.

Install the Light Shield in Cell Compartment #2.



2. Clean the outside of the vials with a damp towel followed by a dry one.



3. Insert the blank into the 16-mm cell holder.

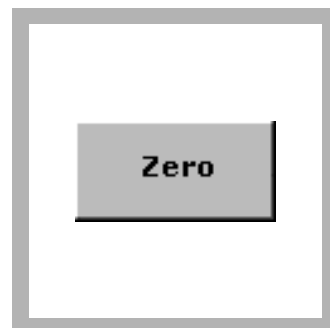

4. Press **ZERO**.

The display will show:
0.0 mg/L COD

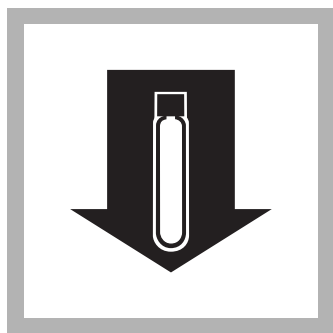

5. Insert the sample vial into the 16-mm cell holder.

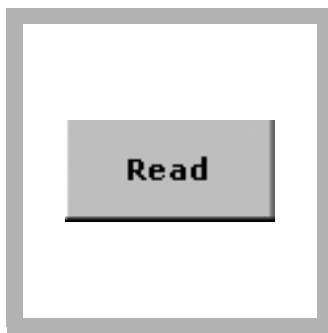

6. Press **READ**.
Results are in mg/L COD.

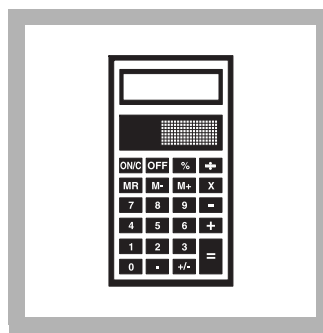

7. If using High Range Plus COD Digestion Reagent Vials, multiply the result by 10.

For most accurate results with samples near 1500 or 15,000 mg/L COD, repeat the analysis with a diluted sample.

Blanks for Colorimetric Determination

The blank may be used repeatedly for measurements using the same lot of vials. Store it in the dark. Monitor decomposition by measuring the absorbance at the appropriate wavelength (356, 420, or 620 nm). Zero the instrument in the absorbance mode, using a vial containing 5 mL of deionized water and measure the absorbance of the blank. Record the value. Prepare a new blank when the absorbance has changed by about 0.01 absorbance units.

Interferences

Chloride is the primary interference when determining COD concentration. Each COD vial contains mercuric sulfate that will eliminate chloride interference up to the level specified in column 1 in [Table 1](#). Samples with higher chloride concentrations should be diluted. Dilute the sample enough to reduce the chloride concentration to the level given in column 3.

If sample dilution will cause the COD concentration to be too low for accurate determination, add 0.50 g of mercuric sulfate (HgSO_4) (Cat. No. 1915-20) to each COD vial before the sample is added. The additional mercuric sulfate will raise the maximum chloride concentration allowable to the level given in column 4 of [Table 1](#).

Table 1 Interferences and Levels

Vial Type Used	Maximum Cl^- concentration in sample (mg/L)	Suggested Cl^- concentration of diluted samples (mg/L)	Maximum Cl^- concentration in sample when 0.50 HgSO_4 added
Ultra Low Range ¹ (0.7–40.0 mg/L)	2000	1000	N/A
Low Range (3–150 mg/L)	2000	1000	8000
High Range (20–1500 mg/L)	2000	1000	4000
High Range Plus (200–15,000 mg/L)	20,000	10,000	40,000

¹ Ultra Low Range is not available on the DR 2700.

Sampling and Storage

Collect samples in glass bottles. Use plastic bottles only if they are known to be free of organic contamination. Test biologically active samples as soon as possible. Homogenize samples containing solids to assure representative samples. Samples treated with sulfuric acid* to a pH of less than 2 (about 2 mL per liter) and refrigerated at 4 °C can be stored up to 28 days. Correct results for volume additions.

Accuracy Check

Standard Solution Method

Important Note: For the DR 2700, begin the Standard Solution Method at step 2.

1. Check the accuracy of the 0.7 to 40.0 mg/L range (**DR 2800 only**) with a 30 mg/L COD standard solution. Using class A glassware, prepare a 1000 mg/L solution by diluting 850 mg dried (120 °C, overnight) potassium acid phthalate (KHP) in 1000 mL of organic-free deionized water. Prepare a 30 mg/L dilution by diluting 3.00 mL of this solution into a 100.0 mL volumetric flask. Dilute to volume with deionized water, stopper, and invert 10 times to mix. Use 2 mL as the sample volume. The result should be 30 mg/L COD.
 - To adjust the calibration curve using the reading obtained with the 30 mg/L COD standard solution, press **OPTIONS>MORE** on the current program menu. Press **STANDARD ADJUST**.
 - Press **ON**. Press **ADJUST** to accept the displayed concentration. If an alternate concentration is used, press the number in the box to enter the actual concentration, then press **OK**. Press **ADJUST**.
2. Check the accuracy of the 3 to 150 mg/L range with a 100 mg/L standard. Prepare by dissolving 85 mg of dried (120 °C, overnight) potassium acid phthalate (KHP) in 1 liter of deionized water. Use 2 mL as the sample volume. The result should be 100 mg/L COD. Or dilute 10 mL of 1000-mg/L COD Standard Solution to 100 mL to produce a 100-mg/L standard.
 - To adjust the calibration curve using the reading obtained with the 100 mg/L COD standard solution, press **OPTIONS>MORE** on the current program menu. Press **STANDARD ADJUST**.
 - Press **ON**. Press **ADJUST** to accept the displayed concentration. If an alternate concentration is used, press the number in the box to enter the actual concentration, then press **OK**. Press **ADJUST**.
3. Check the accuracy of the 20 to 1,500 mg/L range by using either a 300 mg/L or 1000 mg/L COD Standard Solution. Use 2 mL of one of these solutions as the sample volume; the expected result will be 300 or 1000 mg/L COD respectively. Or, prepare a 500 mg/L standard by dissolving 425 mg of dried (120 °C, overnight) KHP. Dilute to 1 liter with deionized water.
 - To adjust the calibration curve using the reading obtained with the 300 mg/L or 1000 mg/L COD standard solution, press **OPTIONS>MORE** on the current program menu. Press **STANDARD ADJUST**.
 - Press **ON**. Press **ADJUST** to accept the displayed concentration. If an alternate concentration is used, press the number in the box to enter the actual concentration, then press **OK**. Press **ADJUST**.

* See [Optional Reagents on page 7](#).

4. Check the accuracy of the 200 to 15,000 mg/L range by using a 10,000 mg/L COD standard solution. Prepare the 10,000 mg/L solution by dissolving 8.500 g of dried (120 °C, overnight) KHP in 1 liter of deionized water. Use 0.2 mL of this solution as the sample volume; the expected result will be 10,000 mg/L COD.
 - To adjust the calibration curve using the reading obtained with the 10,000 mg/L COD standard solution, press **OPTIONS>MORE** on the current program menu. Press **STANDARD ADJUST**.
 - Press **ON**. Press **ADJUST** to accept the displayed concentration. If an alternate concentration is used, press the number in the box to enter the actual concentration, then press **OK**. Press **ADJUST**.

Alternate Reagents

Mercury-free COD2 Reagents can provide a mercury-free testing option for non-reporting purposes. For process control applications, COD2 Reagents will eliminate mercury waste and save on disposal costs. These reagents are fully compatible with test procedures and calibration curves programmed into the spectrophotometer. Determine chloride and ammonia for accurate results.

Note: These reagents are not approved for USEPA reporting purposes. Request a copy of the COD Reagent Vial Information Brochure, Lit. No. 1356, for more information about specific applications.

Summary of Method

The mg/L COD results are defined as the mg of O₂ consumed per liter of sample under conditions of this procedure. In this procedure, the sample is heated for two hours with a strong oxidizing agent, potassium dichromate. Oxidizable organic compounds react, reducing the dichromate ion (Cr₂O₇²⁻) to green chromic ion (Cr³⁺). When the 0.7–40.0 or the 3–150 mg/L colorimetric method is used, the amount of Cr⁶⁺ remaining is determined. When the 20–1500 mg/L or 200–15,000 mg/L colorimetric method is used, the amount of Cr³⁺ produced is determined. The COD reagent also contains silver and mercury ions. Silver is a catalyst, and mercury is used to complex chloride interferences. Test results for the 0.7 to 40.0 mg/L range are measured at 350 nm. Test results for the 3 to 150 mg/L range are measured at 420 nm. Test results for the 20 to 1500 and the 2000 to 15,000 mg/L COD range are measured at 620 nm.

Consumables and Replacement Items

Required Reagents

Description	Quantity/Test	Unit	Cat. No.
Select the appropriate COD Digestion Reagent Vial:			
Ultra Low Range, 0.7 to 40 mg/L COD	1–2 vials	25/pkg	24158-25
Low Range, 3 to 150 mg/L COD	1–2 vials	25/pkg	21258-25
High Range, 20 to 1500 mg/L COD	1–2 vials	25/pkg	21259-25
High Range Plus, 200 to 15,000 mg/L COD	1–2 vials	25/pkg	24159-25
Water, deionized	varies	4 L	272-56

Oxygen Demand, Chemical (0.7 to 40.0, 3 to 150, 20 to 1500 and 200 to 15,000 mg/L COD)

Alternate Reagents¹

Description	Quantity/Test	Unit	Cat. No.
Select the appropriate COD Digestion Reagent Vial:			
COD2, Low Range, 0 to 150 mg/L COD	1–2 vials	25/pkg	25650-25
COD2, High Range, 0 to 1500 mg/L COD	1–2 vials	25/pkg	25651-25
COD2, High Range, 0 to 1500 mg/L COD	1–2 vials	150/pkg	25651-15
COD2, High Range Plus, 0 to 15,000 mg/L COD	1–2 vials	25/pkg	28343-25

¹ These reagents are not approved for USEPA reporting purposes. Request a copy of the COD Reagent Vial Information Brochure, Lit. No. 1356, for more information about specific applications

Required Apparatus

Description	Quantity/Test	Unit	Cat. No.
Blender, 2-speed, 120 VAC	1	each	26161-00
Blender, 2-speed, 240 VAC	1	each	26161-02
DRB200 Reactor, 110 V, 15 x 16 mm	1	each	LTV082.53.40001
DRB200 Reactor, 220 V, 15 x 16 mm	1	each	LTV082.52.40001
Light Shield	1	each	LZV646

Recommended Standards

Description	Unit	Cat. No.
COD Standard Solution, 300-mg/L	200 mL	12186-29
COD Standard Solution, 1000-mg/L	200 mL	22539-29
Oxygen Demand Standard (BOD, COD, TOC)	16 10-mL ampules	28335-10
Pipet Filler, safety bulb	1	each
Pipet, TenSette®, 0.1 to 1.0 mL	1	each
Pipet Tips, for TenSette Pipet 19700-01	1	50/pkg
Pipet, Volumetric, Class A, 2.00 mL	1	each
Potassium Acid Phthalate, ACS	500 g	315-34
Stirrer, Electromagnetic, 120 VAC, with electrode stand	1	each
Stirrer, Electromagnetic, 230 VAC, with electrode stand	1	each
Test Tube Rack	1–2	each

Optional Reagents

Description	Unit	Cat. No.
COD Digestion Reagent Vials, 3 to 150 mg/L COD	150/pkg	21258-15
COD Digestion Reagent Vials, 200 to 1500 mg/L COD	150/pkg	21259-15
Mercuric Sulfate, 28 g	—	1915-20
Sulfuric Acid, 500 mL	—	979-49



FOR TECHNICAL ASSISTANCE, PRICE INFORMATION AND ORDERING:

In the U.S.A. – Call toll-free 800-227-4224
Outside the U.S.A. – Contact the HACH office or distributor serving you.
On the Worldwide Web – www.hach.com; E-mail – techhelp@hach.com

HACH COMPANY
WORLD HEADQUARTERS
Telephone: (970) 669-3050
FAX: (970) 669-2932

Oxygen Demand, Chemical

Manganese III Reactor Digestion Method (with optional chloride removal)¹

(30 to 1000 mg/L COD Mn)

Method 10067

Scope and Application: For water and wastewater

¹ U.S. Patent 5,556,787



Test Preparation

Before starting the test:

Important Note: Install the light shield in Cell Compartment #2 before performing this test.

To determine if the sample contains chloride, use Quantab[®] Titrator Strips for low range chloride.

If the sample COD is expected to exceed 1000 mg/L, dilute the sample as described in [Table 1 on page 3](#).

Homogenizing the sample promotes even distribution of solids and improves accuracy and reliability.

Run one blank with each lot of reagent. Run all samples and blanks with the same lot of vials. The lot number appears on the container label.

The stability of the reagent blank allows for reuse. Verify the reagent blank quality by measuring the absorbance of the blank vs. a clean COD vial filled with deionized water. The absorbance range should be about 1.41–1.47.

If the sample boils during the digestion, the vial is not properly sealed. Test results will be invalid.

Spilled reagent will affect test accuracy and is hazardous. Do not run tests with spilled vials.

The maximum range of the VPD gauge is 40 inches of water; it will not indicate the full vacuum level obtained. Full vacuum is 20–25 inches of mercury; this can be measured at the vacuum pump with a gauge calibrated for inches of mercury.

Collect the following items

Quantity

Blender	1
DRB200 Reactor	1
Forceps, extra fine	1
Light Shield	1
Manganese III COD Reagent Vials, 20–1000 mg/L COD	1
Pipet, TenSette [®] (0.1 to 1.0 mL and 1.0 to 10.0 mL)	1 each
Pipet Tips for TenSette Pipet	2 of each
Sulfuric Acid, concentrated, ACS	1 mL
Test Tube Rack	1
Vacuum pretreatment device	1
Vacuum Pump	1
Vial, glass, for sample and acid	2
Water, deionized	varies

Note: Reorder information for consumables and replacement items is on [page 8](#).

Preparing the Acidified Sample

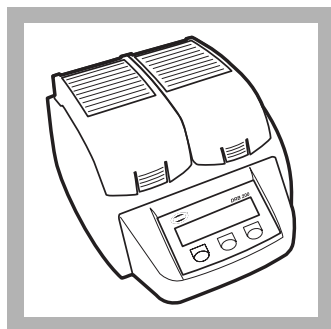

1. Turn on the DRB200 Reactor and heat to 150 °C.

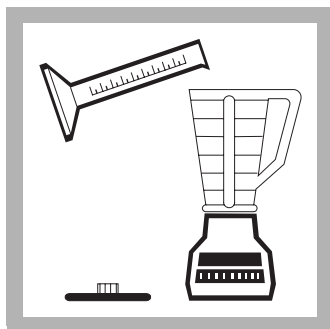

2. Homogenize 100 mL of sample for 30 seconds in a blender.
If suspended solids are present, continue to mix the sample while pipetting.

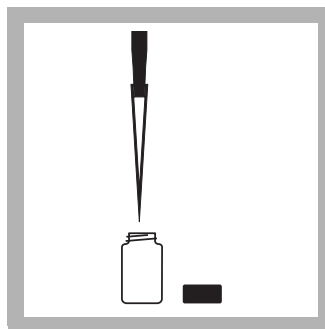

3. **Blank Preparation:** Pipet 9.0 mL of deionized water into an empty glass mixing cell.

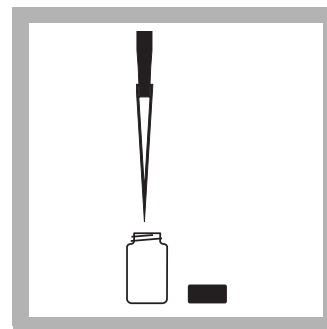

4. **Prepared Sample:** Pipet 9.0 mL of homogenized sample into another empty glass mixing cell

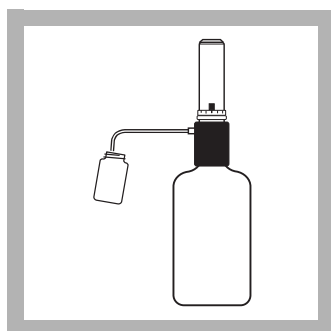

5. Using an automatic dispenser or TenSette® Pipet, add 1.0 mL of concentrated sulfuric acid to both the sample cell and the blank.

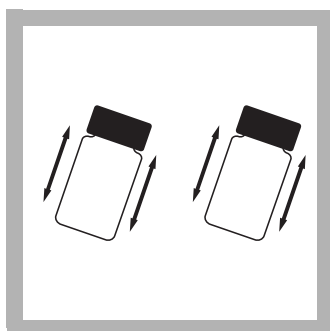

6. Cap the cells tightly and invert several times.
The solution will become hot. Cool to room temperature before proceeding.

Acidified samples are stable for several months when refrigerated at 4 °C.

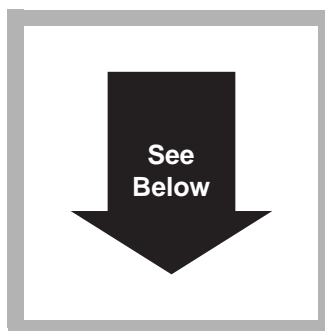

7. Proceed to [Using the Vacuum Pretreatment Device on page 3.](#)

Calculating the Multiplication Factor

All dilutions require that the ratio of sample to sulfuric acid remain at 9:1. For other dilutions that are not listed in [Table 1](#), add the sample volume and the deionized water and divide by the sample volume to obtain the multiplication factor.

Mixing concentrated sulfuric acid and water is not additive. Adding 1.0 mL of concentrated sulfuric acid to 9.0 mL of sample does not result in final volume of 10.0 mL. This factor is built into the calibration curve.

Note: *Mixing concentrated sulfuric acid and water is not additive. Adding 1.0 mL of concentrated sulfuric acid to 9.0 mL of sample does not result in a final volume of 10.0 mL. This factor is built into the calibration curve.*

Table 1 Multiplication Factors

Sample (mL)	Deionized Water (mL)	Range (mg/L COD)	Multiplication Factor
6.0	3.0	30–1500	1.5
3.0	6.0	60–3000	3
1.0	8.0	180–9000	9
0.5	8.5	360–18,000	18

For best results, use 0.5 mL or more of sample for diluting. If sample values exceed 18,000 mg/L COD, use a separate sample dilution before performing the sample chloride removal procedure.

Example: Dilute the sample to a range of 90–4500 mg/L COD.

Sample Volume (2.0 mL) + Deionized water (7.0 mL) = Total Volume (9.0 mL)

$$\text{Multiplication Factor} = \frac{\text{Total Volume}}{\text{Sample Volume}} = \frac{9.0 \text{ mL}}{2.0 \text{ mL}} = 4.5$$

Standard test range is 50 to 1000 mg/L COD.

Example test range = 4.5(50) to 4.5(1000) = 225 to 4500 mg/L COD

Using the Vacuum Pretreatment Device

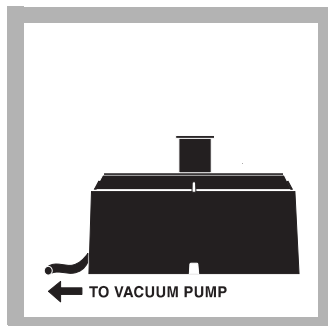

1. Attach the Vacuum Pretreatment Device¹ (VPD) to a vacuum pump (not an aspirator-type vacuum) that can create a vacuum of 20–25 inches of mercury.

¹ Patent Pending

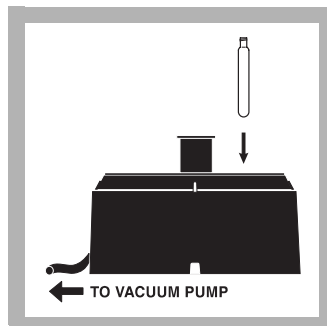

2. Label each Mn III COD vial and remove the cap. Insert the vials in one of the numbered holes in the VPD base.

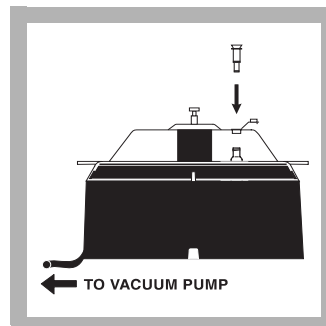

3. Place the VPD top on the base. Insert a fresh Chloride Removal Cartridge² (CRC) directly above each Mn III COD Reagent Vial. Plug any open holes in the VPD top using the stoppers provided.

² U.S. Patents 5,667,754; 5,683,914

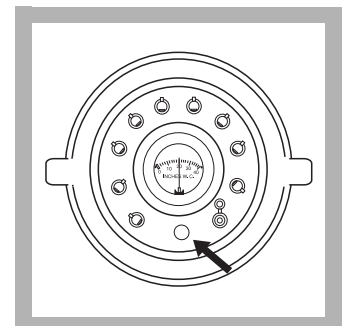

4. Turn on the vacuum pump and adjust the vacuum regulator valve on top of the VPD until the internal gauge reads 20 inches of water.

If the sample does not flow through the Chloride Removal Cartridge (CRC), increase the vacuum until flow starts, then reduce the vacuum down to 20 inches of water. Proceed as usual.

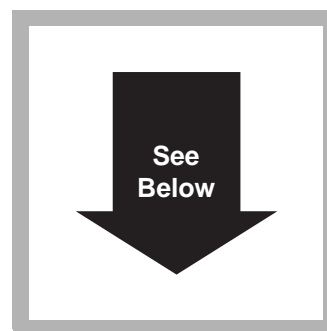
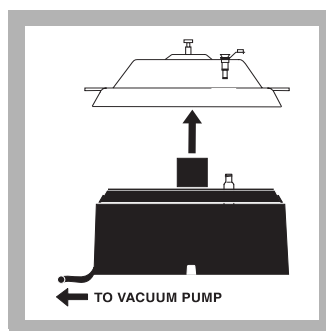
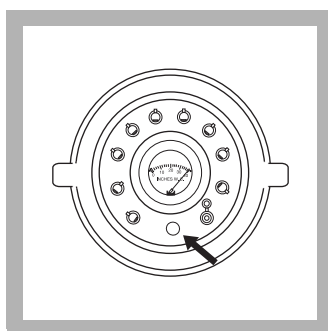
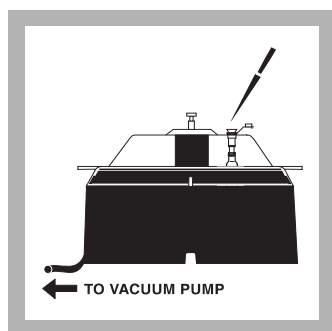

5. Pipet 0.60 mL of acidified sample (see [Preparing the Acidified Sample on page 2](#)) into the CRC. Pipet 0.6 mL of acidified blank into another CRC. It should take 30–45 seconds to draw the liquid through the CRC into each vial.

6. Close the vacuum regulator valve completely to achieve full vacuum. After one minute of full vacuum, slide the VPD back and forth several times to dislodge any drops clinging to the cartridge.

7. Open the VPD regulator valve to release the vacuum. Turn the pump off. Remove the VPD top and set it beside the base.

Dispose of the used Chloride Removal Cartridge. Do not reuse it.

8. Proceed to [Sample Preparation and Measurement on page 4](#).

Sample Preparation and Measurement

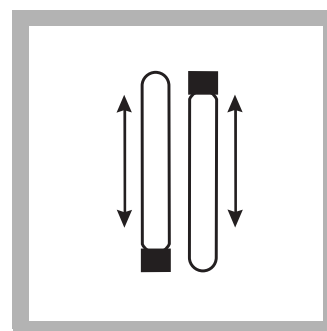
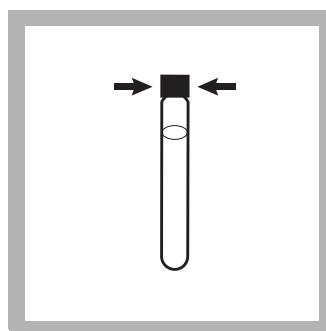
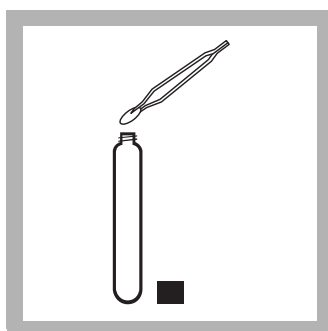
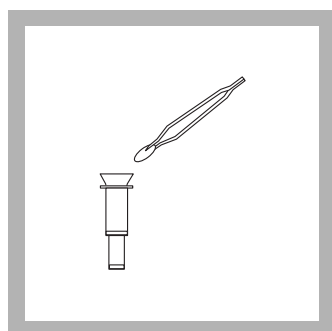

1. Use forceps to remove the filter from the top of each CRC.

If the sample does not contain suspended solids, it is not necessary to transfer the filter to the digestion vial.

2. Insert each filter in the corresponding Mn III COD Vial. (Use numbers on the VPD as a guide.)

To avoid cross-contamination between samples, clean forcep tips between samples by wiping with a clean towel or rinsing with deionized water.

3. Remove the Mn III COD vial from the vacuum chamber and replace the original cap. Screw the cap on tightly.

4. Invert the vials several times to mix.



5. Insert the vials in the DRB200 Reactor at 150 °C. Close the protective cover. Digest for one hour.

To oxidize resistant organics, samples can be digested for up to four hours. Digest the blank for the same time period as the samples.

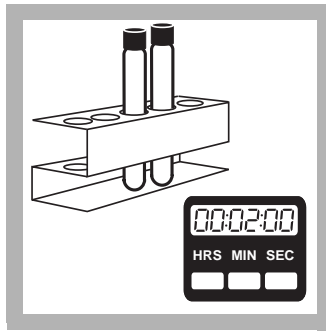

6. Insert the vials in a cooling rack for two minutes.

If the solution develops a colorless upper layer and a purple lower layer, invert the vial several times to mix and proceed to the next step.

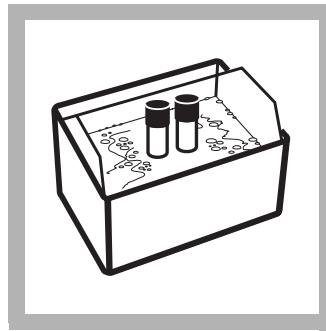

7. Cool the vials to room temperature in a cool water bath or with running tap water for several minutes.

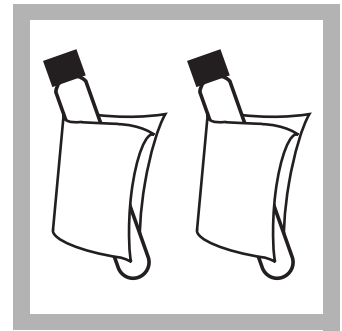

8. Remove the vials from the water and wipe with a clean, dry paper towel.

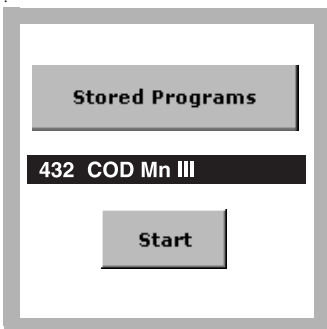

9. Select the test.
Install the Light Shield in Cell Compartment #2.

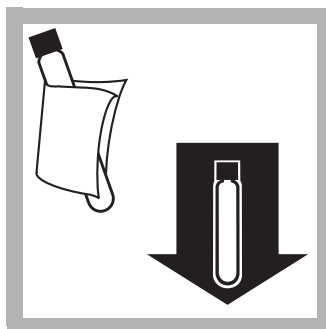

10. Insert the blank into the 16-mm cell holder.

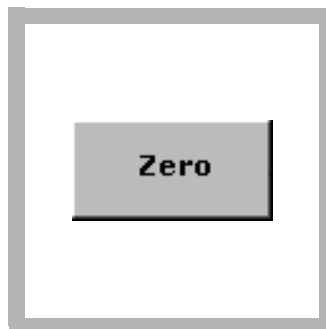

11. Press **ZERO**. The display will show: 0 mg/L COD Mn.

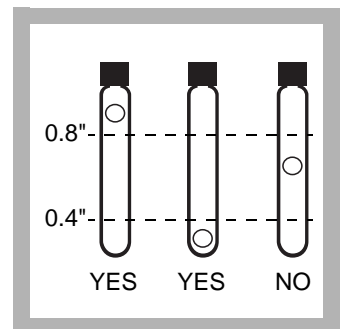

12. Make sure the filter disc is not suspended in the middle of the vial; it can interfere with the instrument reading.

The disc must be more than 20 mm (0.8"), or less than 10 mm (0.4"), from the bottom of the vial. Move it by gently swirling, or by lightly tapping the vial on the table top.

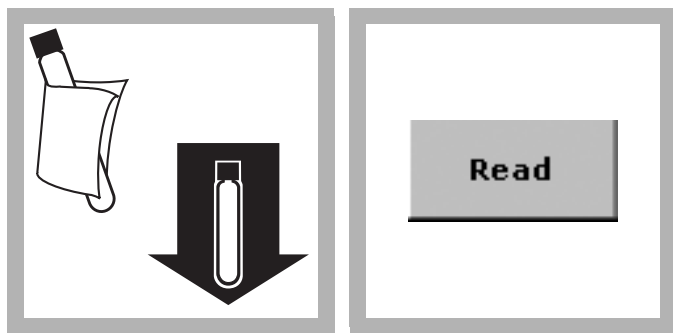

13. Wipe the prepared sample and insert it into the cell holder.

14. Press **READ**.

Results are in mg/L COD Mn.

Interferences

Inorganic materials may also be oxidized by trivalent manganese and constitute a positive interference when present in significant amounts. Chloride is the most common interference and is removed by sample pretreatment with the Chloride Removal Cartridge. If chloride is known to be absent or present in insignificant levels, the pretreatment can be omitted. A simple way to determine if chloride will affect test results is to run routine samples with and without the chloride removal, then compare results. Other inorganic interferences (i.e., nitrite, ferrous iron, sulfide) are not usually present in significant amounts. If necessary, these interferences can be corrected after determining their concentrations with separate methods and adjusting the final COD test results accordingly.

Ammonia nitrogen is known to interfere in the presence of chloride; it does not interfere if chloride is absent.

Sample Collection, Preservation, and Storage

Collect samples in clean glass bottles. Use plastic bottles only if they are known to be free of organic contamination. Test biologically active samples as soon as possible. Homogenize samples containing solids to assure representative samples. Samples treated with concentrated sulfuric acid to a pH of less than 2 (about 2 mL per liter) and refrigerated at 4 °C may be stored up to 28 days. Correct results for volume additions.

Accuracy Check

Standard Solution Method

1. Purchase a 800-mg/L COD Standard Solution or prepare an 800-mg/L COD standard solution by adding 0.6808 g of dried (103 °C, overnight) potassium acid phthalate (KHP) to 1 liter of deionized water. Use 0.60 mL of this solution as the sample volume. (Use 0.50 mL if performing the method version without chloride removal.)
2. To adjust the calibration curve using the reading obtained with the standard solution, press **OPTIONS>MORE** on the current program menu. Press **STANDARD ADJUST**.
3. Press **ON**. Press **ADJUST** to accept the displayed concentration. If an alternate concentration is used, press the number in the box to enter the actual concentration, then press **OK**. Press **ADJUST**.

Summary of Method

Chemical Oxygen Demand (COD) is defined as "... a measure of the oxygen equivalent of the organic matter content of a sample that is susceptible to oxidation by a strong chemical oxidant" (APHA Standard Methods, 19th ed., 1995). Trivalent manganese is a strong, non-carcinogenic chemical oxidant that changes quantitatively from purple to colorless when it reacts with organic matter. It typically oxidizes about 80% of the organic compounds. Studies have shown that the reactions are highly reproducible and test results correlate closely to Biochemical Oxygen Demand (BOD) values and hexavalent chromium COD tests. None of the oxygen demand tests provide 100% oxidation of all organic compounds.

A calibration is provided which is based on the oxidation of Potassium Acid Phthalate (KHP). A different response may be seen in analyzing various wastewaters. The KHP calibration is adequate for most applications. The highest degree of accuracy is obtained when test results are correlated to a standard reference method such as BOD or one of the chromium COD methods. Special waste streams or classes will require a separate calibration to obtain a direct mg/L COD reading or to generate a correction factor for the precalibrated KHP response. The sample digestion time can be extended up to four hours for samples that are difficult to oxidize. Test results are measured at 510 nm.

Consumables and Replacement Items

Required Reagents

Description	Quantity/Test	Unit	Cat. No.
Manganese III COD Reagent Vials, 20–1000 mg/L COD	1	25/pkg	26234-25
Chloride Removal Cartridge (CRC)	1	25/pkg	26618-25
Sulfuric Acid, concentrated, ACS	1 mL	2.5 L	979-09
Water, deionized	varies	4 L	272-56

Required Apparatus

Description	Quantity/Test	Unit	Cat. No.
Blender, 120 VAC	1	each	26747-00
Blender Container, 50–250 mL	1	2/pkg	26748-00
Cap, with inert Teflon liner, for mixing bottle	varies	12/pkg	24018-12
DRB200 Reactor, 110 V, 15 x 16 mm	1	each	LTV082.53.40001
DRB200 Reactor, 220 V, 15 x 16 mm	1	each	LTV082.52.40001
Forceps, extra fine point	1	each	26696-00
Light Shield	1	each	LZV646
Pipet, TenSette®, 1.0 to 10.0 mL	1	each	19700-10
Pipet Tips for TenSette Pipet 19700-10	2	50/pkg	21997-96
Pipet, TenSette, 0.1 to 1.0 mL	1	each	19700-01
Pipet Tips for TenSette Pipet 19700-01	2	50/pkg	21856-96
Test Tube Rack	1	each	18641-00
Vacuum Pretreatment Device (VPD)	1	each	49000-00
Vacuum Pump, 1.2 CFM @ 60 Hz, 27.2 Hg Max, 1/8 HP, UL listed	1	each	28248-00
Vial, glass, for sample plus acid	2	each	24277-00

Recommended Standards

Description	Unit	Cat. No.
COD Standard Solution, 800-mg/L COD	200 mL	26726-29
Oxygen Demand Standard for BOD, COD, TOC, 10-mL ampules	16/pkg	28335-10
Potassium Acid Phthalate, ACS	500 g	315-34
Wastewater Standard, Influent Inorganics, for NH ₃ -N, NO ₃ -N, PO ₄ , COD, SO ₄ , TOC	500 mL	28331-49

Optional Reagents and Apparatus

Description	Cat. No.
Dispenser, automatic, 1.0–5.0 mL	25631-37
Titration Strips, Quantab®, for low range chloride	27449-40



FOR TECHNICAL ASSISTANCE, PRICE INFORMATION AND ORDERING:
 In the U.S.A. – Call toll-free 800-227-4224
 Outside the U.S.A. – Contact the HACH office or distributor serving you.
 On the Worldwide Web – www.hach.com; E-mail – techhelp@hach.com

HACH COMPANY
 WORLD HEADQUARTERS
 Telephone: (970) 669-3050
 FAX: (970) 669-2932

Oxygen Demand, Chemical

Method 10067

Manganese III Reactor Digestion Method
(without chloride removal)¹
(30 to 1000 mg/L COD Mn)

Scope and Application: For water and wastewater

¹ U.S. Patent 5,556,787



Test Preparation

Before starting the test:

Important Note: Install the light shield in Cell Compartment #2 before performing this test.

If the sample contains chloride, use the chloride removal method. To determine if the sample contains chloride, use Quantab[®] Titrator Strips for low range chloride.

If the sample COD value is not between 30 and 1000 mg/L, dilute the sample with deionized water to obtain this range. Multiply the final result by the dilution factor.

Homogenizing the sample promotes even distribution of solids and improves accuracy and reliability.

Stability of the reagent blank allows for reuse. Verify the reagent blank quality by measuring the absorbance of the blank vs. a clean COD vial filled with deionized water. The absorbance range should be about 1.4–1.5.

If the sample boils during the digestion, the vial is not properly sealed. Test results will be invalid.

Use finger cots to handle hot sample cells. Spilled reagent will affect test accuracy and is hazardous. Do not run tests with spilled vials.

See the DRB200 User Manual for selecting pre-programmed temperature applications.

Collect the following items:

Quantity

Blender	1
DRB200 Reactor	1
Light Shield	1
Manganese III COD Reagent Vials, 20–1000 mg/L COD	1
Pipet, TenSette [®] (0.1 to 1.0 mL)	1
Pipet tips for TenSette Pipet	2
Test Tube Rack	1
Water, deionized	varies

Note: Reorder information for consumables and replacement items is on page 4.

Without Chloride Removal

Method 10067

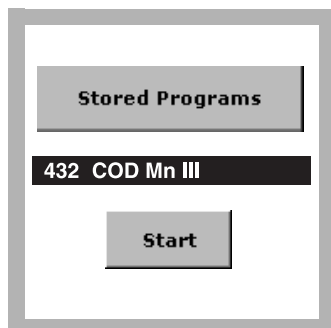

1. Select the test.
Install the Light Shield in Cell Compartment #2.

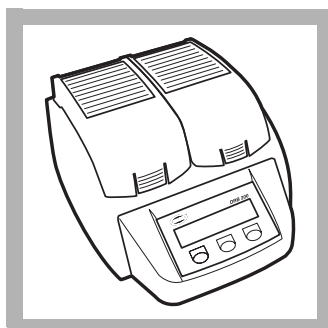

2. Turn on the DRB200 Reactor and heat to 150 °C.

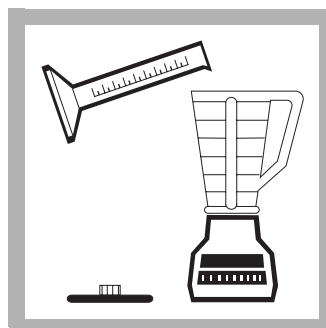

3. Homogenize 100 mL of sample for 30 seconds in a blender.
If suspended solids are present, continue to mix the sample while pipetting.

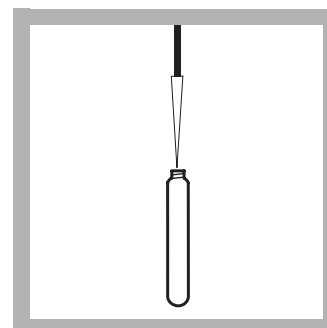

4. Pipet 0.5 mL of homogenized sample into one Mn III COD vial (the prepared sample) and 0.5 mL of deionized water into another Mn III COD vial (the blank).

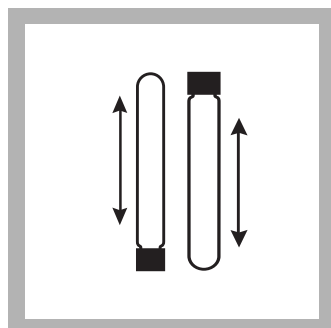

5. Cap and invert several times to mix.

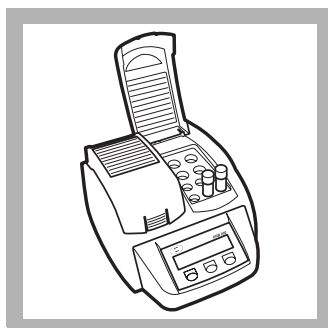

6. Insert the vials in the DRB200 Reactor at 150 °C. Close the protective cover. Digest for one hour.
Digest more resistant organics and the blank for up to four hours.

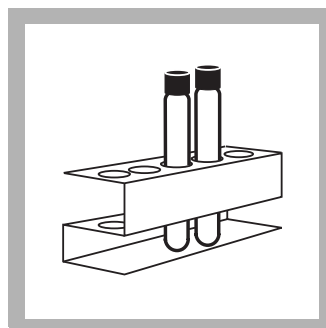

7. Remove the vials and place them in a cooling rack for two minutes.
If a vial develops a colorless upper layer and a purple lower layer, invert the vial several times to mix and proceed.



8. Cool the vials to room temperature in a cool water bath or with running tap water. This takes several minutes.

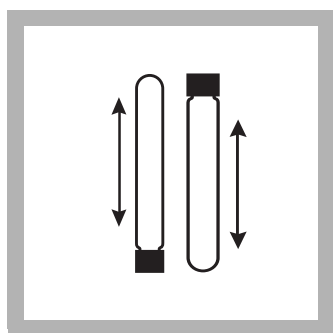

9. Invert the vials several times to mix.

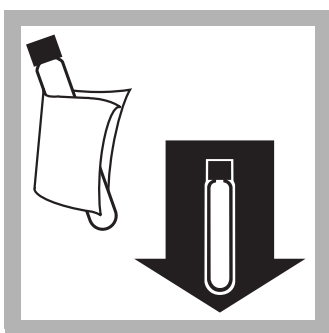

10. Wipe the blank and insert it into the 16-mm round cell holder.

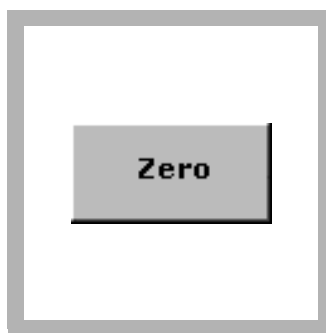

11. Press **ZERO**. The display will show: 0 mg/L COD Mn

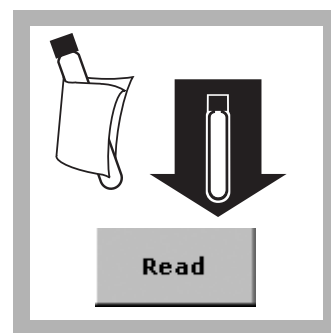

12. Wipe the sample and insert it into the 16-mm round cell holder.

Press **READ**. Results are in mg/L COD Mn.

Interferences

Inorganic materials may also be oxidized by trivalent manganese and constitute a positive interference when present in significant amounts. Chloride is the most common interference and is removed by sample pretreatment with the Chloride Removal Cartridge. If chloride is known to be absent or present in insignificant levels, the pretreatment can be omitted. A simple way to determine if chloride will affect test results is to run routine samples with and without the chloride removal, then compare results. Other inorganic interferences (i.e., nitrite, ferrous iron, sulfide) are not usually present in significant amounts. If necessary, these interferences can be corrected after determining their concentrations with separate methods and adjusting the final COD test results accordingly.

Ammonia nitrogen is known to interfere in the presence of chloride; it does not interfere if chloride is absent.

Sample Collection, Preservation, and Storage

Collect samples in clean glass bottles. Use plastic bottles only if they are known to be free of organic contamination. Test biologically active samples as soon as possible. Homogenize samples containing solids to assure representative samples. Samples treated with concentrated sulfuric acid to a pH of less than 2 (about 2 mL per liter) and refrigerated at 4 °C may be stored up to 28 days. Correct results for volume additions.

Accuracy Check

Standard Solution Method

1. Purchase a 800-mg/L COD Standard Solution or prepare an 800-mg/L COD standard solution by adding 0.6808 g of dried (103 °C, overnight) potassium acid phthalate (KHP) to 1 liter of deionized water. Use 0.50 mL of this solution (0.60 mL for the chloride removal procedure) as the sample volume.
2. To adjust the calibration curve using the reading obtained with the 800-mg/L COD standard solution, press **OPTIONS>MORE** on the current program menu. Press **STANDARD ADJUST**.
3. Press **ON**. Press **ADJUST** to accept the displayed concentration. If an alternate concentration is used, press the number in the box to enter the actual concentration, then press **OK**. Press **ADJUST**.

Summary of Method

Chemical Oxygen Demand (COD) is defined as "... a measure of the oxygen equivalent of the organic matter content of a sample that is susceptible to oxidation by a strong chemical oxidant" (APHA Standard Methods, 19th ed., 1995). Trivalent manganese is a strong, non-carcinogenic chemical oxidant that changes quantitatively from purple to colorless when it reacts with organic matter. It typically oxidizes about 80% of the organic compounds. Studies have shown that the reactions are highly reproducible and test results correlate closely to Biochemical Oxygen Demand (BOD) values and hexavalent chromium COD tests. None of the oxygen demand tests provide 100% oxidation of all organic compounds.

A calibration is provided which is based on the oxidation of Potassium Acid Phthalate (KHP). A different response may be seen in analyzing various wastewaters. The KHP calibration is adequate for most applications. The highest degree of accuracy is obtained when test results are correlated to a standard reference method such as BOD or one of the chromium COD methods. Special waste streams or classes will require a separate calibration to obtain a direct mg/L COD reading or to generate a correction factor for the precalibrated KHP response. The sample digestion time can be extended up to four hours for samples that are difficult to oxidize. Test results are measured at 510 nm.

Consumables and Replacement Items

Required Reagents

Description	Quantity/Test	Unit	Cat. No.
Manganese III COD Reagent Vials, 20–1000 mg/L COD	1	25/pkg	26234-25
Water, deionized	varies	4 L	272-56

Required Apparatus

Description	Quantity/Test	Unit	Cat. No.
Blender, 120 VAC	1	each	26747-00
Blender Container, 50–250 mL	1	2/pkg	26748-00
DRB200 Reactor, 110 V, 15 x 16 mm	1	each	LTV082.53.40001
DRB200 Reactor, 220 V, 15 x 16 mm	1	each	LTV082.52.40001
Light Shield	1	each	LZV646
Pipet, TenSette®, 0.1 to 1.0 mL	1	each	19700-01
Pipet Tips, for TenSette Pipet 19700-01	2	50/pkg	21856-96
Test Tube Rack	1	each	18641-00

Recommended Standards

Description	Unit	Cat. No.
COD Standard Solution, 800-mg/L COD	200 mL	26726-29
Oxygen Demand Standard for BOD, COD, TOC, 10-mL ampules	16/pkg	28335-10
Potassium Acid Phthalate, ACS	500 g	315-34
Wastewater Standard, Influent Inorganics, for NH ₃ -N, NO ₃ -N, PO ₄ , COD, SO ₄ , TOC	500 mL	28331-49



FOR TECHNICAL ASSISTANCE, PRICE INFORMATION AND ORDERING:
In the U.S.A. – Call toll-free 800-227-4224
Outside the U.S.A. – Contact the HACH office or distributor serving you.
On the Worldwide Web – www.hach.com; E-mail – techhelp@hach.com

HACH COMPANY
WORLD HEADQUARTERS
Telephone: (970) 669-3050
FAX: (970) 669-2932

Oxygen Demand, Chemical

★Method 10211

Reactor Digestion Method

TNTplus™ 820

ULR (1–60 mg/L COD)

Scope and Application: For wastewater, process water, surface water, and cooling water; digestion is required



Test Preparation

Before starting the test:

Important Note: Install the light shield in Cell Compartment #2 before performing this test.

Please read Safety Advice and Expiration Date on package.

Recommended sample and reagent temperature is 15–25 °C (59–77 °F).

Recommended reagent storage temperature is 15–25 °C (59–77 °F).

Some of the chemicals and apparatus used in this procedure may be hazardous to the health and safety of the user if inappropriately handled or accidentally misused. Please read all warnings and associated MSDS sheets.

To run the optional blank for a set of samples, see [Blanks for Colorimetric Determination on page 3](#).

TNTplus methods are activated from the Main Menu screen by inserting the sample vial into the sample cell holder.

Spilled reagent will affect test accuracy and is hazardous to skin and other materials.

Be prepared to wash spills with running water.

Wear appropriate eye protection and clothing for adequate user protection. If contact occurs, flush the affected area with running water. Review and follow instructions carefully.

Store unused (light-sensitive) vials in a closed box.

Collect the following items:

Quantity

Blender	1
DRB200 Reactor with 13-mm wells (use adapters with 16-mm holes)	1
COD TNT820 Reagent Set	varies
Light Shield	1
Pipettor for 2.0 mL Sample	1
Pipettor Tip	1
Test Tube Rack	1–3

Note: Reorder information for consumables and replacement items is on [page 5](#).

TNTplus

Method 10211

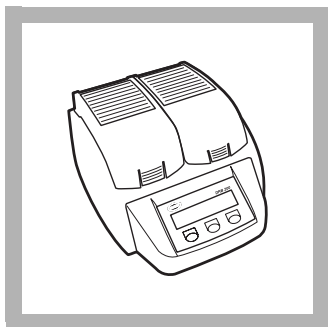

1. Turn on the DRB200 Reactor. Preheat to 150 °C.

Note: For DRB200 Reactors with 16-mm wells, insert a 16-mm to 13-mm adapter sleeve into each well **before** turning on the reactor.

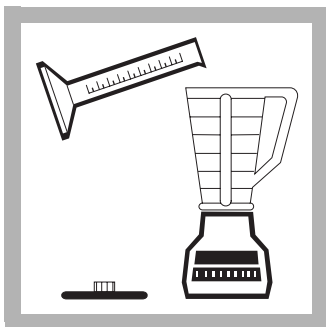

2. Homogenize 100 mL of sample for 30 seconds in a blender. For samples containing large amounts of solids, increase the homogenization time.

If the sample does not contain suspended solids, omit steps 2 and 3.

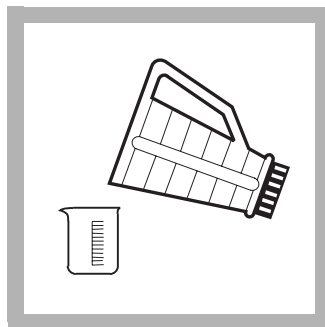

3. To help ensure that a representative portion of sample is analyzed, pour the homogenized sample into a 250-mL beaker and gently stir with a magnetic stir plate.

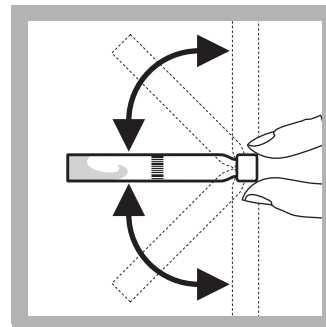

4. Invert a vial several times to bring the sediment in the bottom of the vial into suspension.

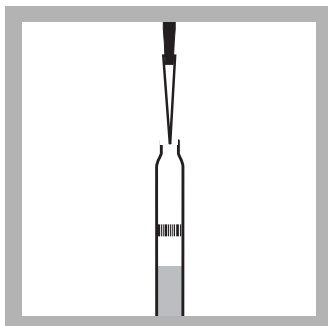

5. Carefully pipet 2.0 mL of sample into the vial. Cap and clean the outside of the vial.

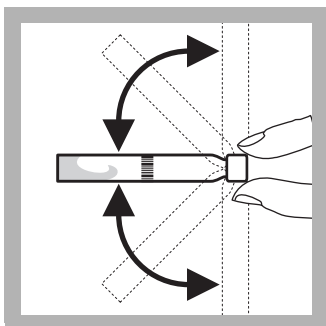

6. Hold the vial by the cap over a sink. Invert gently several times to mix. The sample vial will become very hot during mixing.

Place the vials in the preheated DRB200 Reactor. Close the protective lid

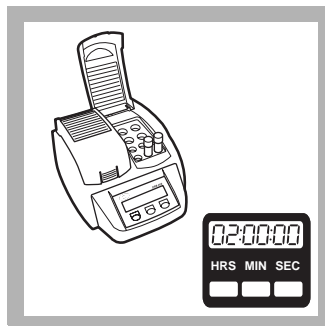

7. Heat for two hours.

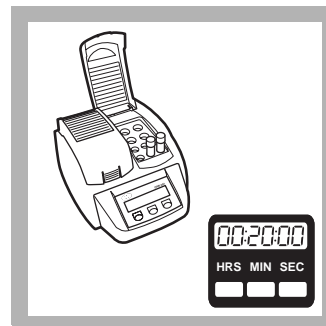

8. Turn the reactor off. Wait about 20 minutes for the vial to cool to 120 °C or less.

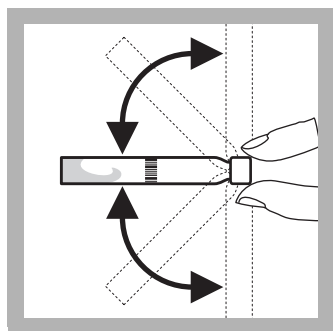

9. Invert the vial several times while still hot.

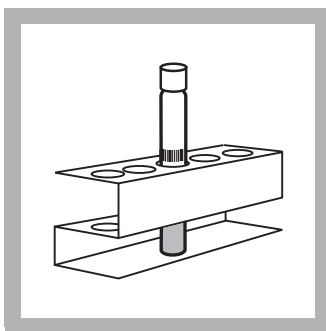

10. Place the vial into a rack to cool to room temperature.

Install the Light Shield in Cell Compartment #2.

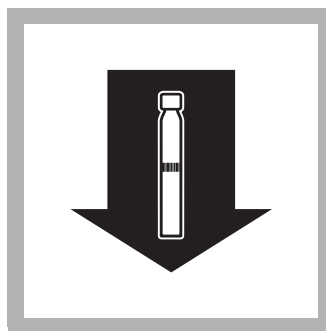

11. Using the Zero vial from the sample vial lot, insert the Zero vial into the sample cell holder.

The instrument reads the barcode, then selects the method and set the instrument zero. The instrument displays L1 when the zeroing is complete.

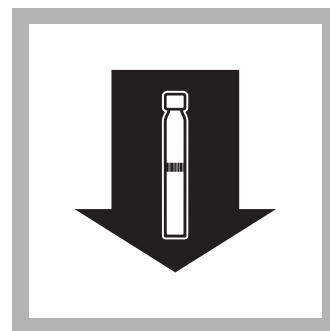

12. Thoroughly clean the outside of the vial and insert it into the cell holder. Close the lid.

The instrument reads the barcode and reads the sample.

Results are in mg/L COD.

Blanks for Colorimetric Determination

A reagent blank can be measured, and the value subtracted from the results of each test performed using the same reagent lot number. The blank may be used repeatedly for measurements using the same lot of vials. Store it in the dark, and monitor decomposition by measuring its concentration periodically.

To subtract the value of the blank from a series of measurements, measure the blank per step 12. Press **OPTIONS>MORE>REAGENT BLANK**. Select **ON**. The measured value of the blank should be displayed in the highlighted box. Press **OK** to accept this value. The reagent blank value will now be subtracted from all results until the function is turned off, or a different method is selected. Alternately, the blank can be recorded and entered at any later time by pressing the highlighted box and using the keypad to enter the value.

Interferences

Chloride is the primary interference when determining COD concentration. Each COD vial contains mercuric sulfate that will eliminate chloride interference up to 1500 mg/L Cl⁻. COD concentrations greatly in excess of the stated range will adversely affect color formation, resulting in a false reading that appears within the range of the method.

Sampling and Storage

Collect samples in glass bottles. Use plastic bottles only if they are known to be free of organic contamination. Test biologically active samples as soon as possible. Homogenize samples containing solids to assure representative samples. Samples treated with sulfuric acid* to a pH of less than 2 (about 2 mL per liter) and refrigerated at 4 °C can be stored up to 28 days. Correct results for volume additions.

* See [Optional Reagents and Apparatus on page 5](#).

Accuracy Check

Standard Solution Method

1. Check the accuracy of the 1 to 60 mg/L range with a 50 mg/L standard. Prepare by dissolving 42.5 mg of dried (120 °C, overnight) potassium acid phthalate (KHP) in 1 liter of deionized water. Use 2 mL as the sample volume. The result should be 50 mg/L COD. Or, dilute 5 mL of 1000-mg/L COD Standard Solution to 100 mL to produce a 50-mg/L standard.
2. Alternatively, use 2.0 mL of a Wastewater Effluent Mixed Inorganics Standard Solution. This standard contains 25 mg/L COD in the presence of other ions such as phosphate, nitrate, ammonia, and sulfate.

Summary of Method

The mg/L COD results are defined as the mg of O₂ consumed per liter of sample under conditions of this procedure. In this procedure, the sample is heated for two hours with a strong oxidizing agent, potassium dichromate. Oxidizable organic compounds react, reducing the dichromate ion (Cr₂O₇²⁻) to green chromic ion (Cr³⁺). With this method, the amount of yellow Cr⁶⁺ remaining is determined. The COD reagent also contains silver and mercury ions. Silver is a catalyst, and mercury is used to complex chloride interferences. Test results are measured at 348 nm.

Consumables and Replacement Items

Required Reagents

Description	Quantity/Test	Unit	Cat. No.
Oxygen Demand, ULR TNT820 Reagent Set	1–2 vials	24/pkg	TNT820

Required Apparatus

Description	Quantity/Test	Unit	Cat. No.
DRB200 Reactor, 115 V, 9x13 mm + 2x20mm (mono block)	1	each	DRB200-01
OR			
DRB200 Reactor, 230 V, 9x13 mm + 2x20mm (mono block)	1	each	DRB200-05
Light Shield	1	each	LZV646
Pipet, variable volume, 1–5 mL	1	each	27951-00
Pipet Tips, for 27951-00 pipet	1	100/pkg	27952-00
Test Tube Rack	1–3	each	18641-00

Recommended Standards

Description	Unit	Cat. No.
COD Standard Solution, 1000-mg/L	200 mL	22539-29
Potassium Acid Phthalate, ACS	500 g	315-34
Wastewater Effluent Standard, for mixed parameters (NH ₃ -N, NO ₃ -N, PO ₄ , COD, SO ₄ , TOC)	500 mL	28332-49

Optional Reagents and Apparatus

Description	Unit	Cat. No.
Beaker, 250 mL	each	500-46H
Blender, 2-speed, 120 VAC	each	26161-00
Blender, 2-speed, 240 VAC	each	26161-02
DRB200 Reactor, 115 V, 21x13 mm + 4x20 mm (dual block)	each	DRB200-02
DRB200 Reactor, 115 V, 15x13 mm + 15x13 mm (dual block)	each	DRB200-03
DRB200 Reactor, 115 V, 12x13 mm + 8x20 mm (dual block)	each	DRB200-04
DRB200 Reactor, 230 V, 21x13mm + 4x20 mm (dual block)	each	DRB200-06
DRB200 Reactor, 230 V, 15x13mm + 15x13 mm (dual block)	each	DRB200-07
DRB200 Reactor, 230 V, 12x13mm + 8x20 mm (dual block)	each	DRB200-08
Stir Plate, magnetic	each	28812-00
Stir Bar, octagonal	each	20953-52
Sulfuric Acid, ACS	500 mL	979-49
TNTplus™ Reactor adapter sleeves, 16-mm to 13-mm diameter	5/pkg	28958-05



FOR TECHNICAL ASSISTANCE, PRICE INFORMATION AND ORDERING:

In the U.S.A. – Call toll-free 800-227-4224
Outside the U.S.A. – Contact the HACH office or distributor serving you.
On the Worldwide Web – www.hach.com; E-mail – techhelp@hach.com

HACH COMPANY
WORLD HEADQUARTERS
Telephone: (970) 669-3050
FAX: (970) 669-2932

Oxygen Demand, Chemical

★Method 10212

Reactor Digestion Method

TNTplus™ 823

UHR (250–15,000 mg/L COD)

Scope and Application: For wastewater and process waters; digestion is required



Test Preparation

Before starting the test:

Important Note: Install the light shield in Cell Compartment #2 before performing this test.

Please read Safety Advice and Expiration Date on package.

Recommended sample and reagent temperature is 15–25 °C (59–77 °F).

Recommended reagent storage temperature is 15–25 °C (59–77 °F).

Some of the chemicals and apparatus used in this procedure may be hazardous to the health and safety of the user if inappropriately handled or accidentally misused. Please read all warnings and associated MSDS sheets.

To run the optional blank for a set of samples, see [Blanks for Colorimetric Determination on page 3](#).

Spilled reagent will affect test accuracy and is hazardous to skin and other materials.

Be prepared to wash spills with running water.

TNTplus methods are activated from the Main Menu screen by inserting the sample vial into the sample cell holder.

Wear appropriate eye protection and clothing for adequate user protection. If contact occurs, flush the affected area with running water. Review and follow instructions carefully.

Store unused (light-sensitive) vials in a closed box.

Collect the following items:

Quantity

Blender	1
DRB200 Reactor with 13-mm wells (use adapters with 16-mm holes)	1
COD, TNT823 Reagent Set	varies
Light Shield	1
Pipettor for 0.3 mL Sample	1
Pipettor Tip	1
Test Tube Rack	1–3

Note: Reorder information for consumables and replacement items is on [page 5](#).

TNTplus

Method 10212

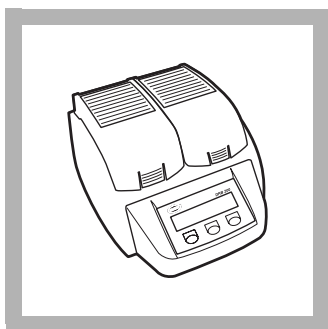

1. Turn on the DRB200 Reactor. Preheat to 150 °C.

Note: For DRB200 Reactors with 16-mm wells, insert a 16-mm to 13-mm adapter sleeve into each well **before** turning on the reactor.

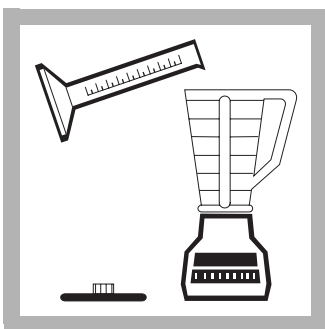

2. Homogenize 100 mL of sample for 30 seconds in a blender. For samples containing large amounts of solids, increase the homogenization time.

If the sample does not contain suspended solids, omit steps 2 and 3.

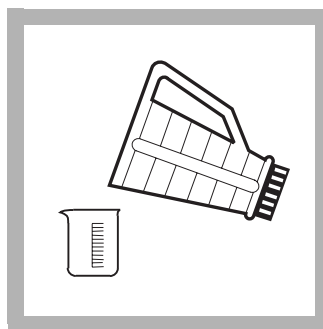

3. To help ensure that a representative portion of sample is analyzed, pour the homogenized sample into a 250-mL beaker and gently stir with a magnetic stir plate.

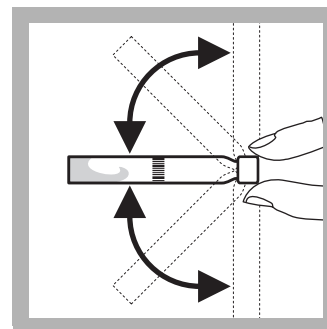

4. Invert a vial several times to bring the sediment in the bottom of the vial into suspension.

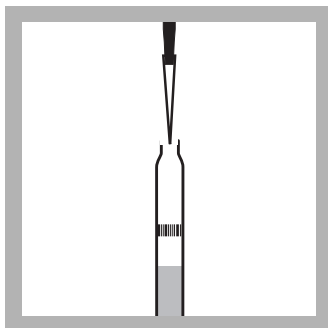

5. Carefully pipet 0.3 mL (300 µL) of sample into the vial. Cap and clean the outside of the vial.

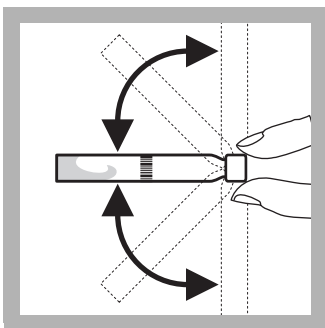

6. Hold the vial by the cap over a sink. Invert gently several times to mix. The sample vial will become very hot during mixing.

Place the vial in the preheated DRB200 Reactor. Close the protective lid

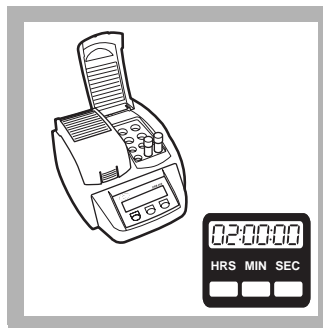

7. Heat for two hours.

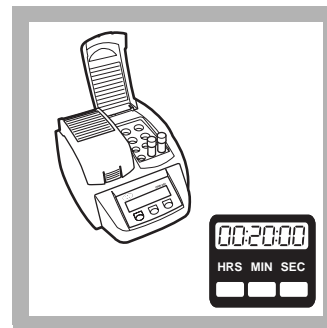

8. Turn the reactor off. Wait about 20 minutes for the vial to cool to 120 °C or less.

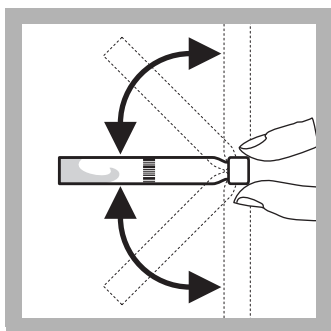

9. Invert the vial several times while still hot.

Install the Light Shield in Cell Compartment #2.

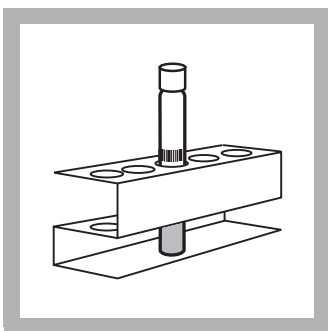

10. Place the vial into a rack to cool to room temperature.

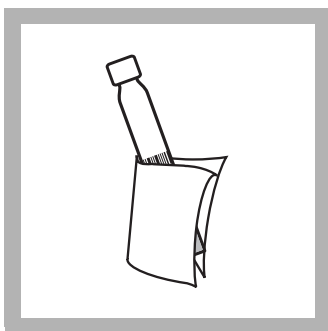

11. Thoroughly clean the outside of the vial.

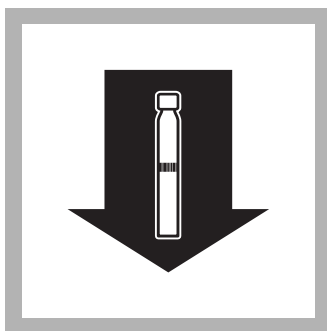

12. Insert the vial into the cell holder. Close the lid.

The instrument reads the barcode, then selects and performs the correct test.

Results are in mg/L COD.

Blanks for Colorimetric Determination

A reagent blank can be measured, and the value subtracted from the results of each test performed using the same reagent lot number. The blank may be used repeatedly for measurements using the same lot of vials. Store it in the dark, and monitor decomposition by measuring its concentration periodically.

To subtract the value of the blank from a series of measurements, measure the blank per step 12. Press **OPTIONS>MORE>REAGENT BLANK**. Select **ON**. The measured value of the blank should be displayed in the highlighted box. Press **OK** to accept this value. The reagent blank value will now be subtracted from all results until the function is turned off, or a different method is selected. Alternately, the blank can be recorded and entered at any later time by pressing the highlighted box and using the keypad to enter the value.

Interferences

Chloride is the primary interference when determining COD concentration. Each COD vial contains mercuric sulfate that will eliminate chloride interference up to 5000 mg/L Cl⁻. COD concentrations greatly in excess of the stated range will adversely affect color formation, resulting in a false reading that appears within the range of the method.

Sampling and Storage

Collect samples in glass bottles. Use plastic bottles only if they are known to be free of organic contamination. Test biologically active samples as soon as possible. Homogenize samples containing solids to assure representative samples. Samples treated with sulfuric acid* to a pH of less than 2 (about 2 mL per liter) and refrigerated at 4 °C can be stored up to 28 days. Correct results for volume additions.

* See [Optional Reagents and Apparatus on page 5](#).

Accuracy Check

Standard Solution Method

1. Check the accuracy of the method range with a 1000 mg/L standard. Prepare by dissolving 0.8503 g of dried (120 °C, overnight) potassium acid phthalate (KHP) in 1 liter of deionized water. Use 0.3 mL as the sample volume. Standard solutions of 1000mg/L COD and 617 mg/L COD are also available.
2. Alternatively, use 0.3 mL of a Wastewater Influent Mixed Inorganics Standard Solution. This standard contains 500 mg/L COD in the presence of other ions such as phosphate, nitrate, ammonia and sulfate.

Summary of Method

The mg/L COD results are defined as the mg of O₂ consumed per liter of sample under conditions of this procedure. In this procedure, the sample is heated for two hours with a strong oxidizing agent, potassium dichromate. Oxidizable organic compounds react, reducing the dichromate ion (Cr₂O₇²⁻) to green chromic ion (Cr³⁺). The amount of green color produced is directly proportional to amount of COD present. The COD reagent also contains silver and mercury ions. Silver is a catalyst, and mercury is used to complex chloride interferences. Test results are measured at 620 nm.

Consumables and Replacement Items

Required Reagents

Description	Quantity/Test	Unit	Cat. No.
Oxygen Demand, UHR TNT823 Reagent Set	1–2 vials	25/pkg	TNT823

Required Apparatus

Description	Quantity/Test	Unit	Cat. No.
DRB200 Reactor, 115 V, 9x13mm + 2x20mm (mono block)	1	each	DRB200-01
OR			
DRB200 Reactor, 230 V, 9x13mm + 2x20mm (mono block)	1	each	DRB200-05
Light Shield	1	each	LZV646
Pipet, variable volume, 100–1000 µL	1	each	27949-00
Pipet Tips, for 27949-00 pipet	1	400/pkg	27950-00
Test Tube Rack	1–3	each	18641-00

Recommended Standards

Description	Unit	Cat. No.
COD Standard Solution, 1000-mg/L	200 mL	22539-29
Potassium Acid Phthalate, ACS	500 g	315-34
Oxygen Demand Standard (BOD, COD, TOC), 10-mL ampules, 617 mg/L COD	16/pkg	28335-10
Wastewater Influent Standard, for mixed parameters (NH ₃ -N, NO ₃ -N, PO ₄ , COD, SO ₄ , TOC)	500 mL	28331-49

Optional Reagents and Apparatus

Description	Unit	Cat. No.
Beaker, 250 mL	each	500-46H
Blender, 2-speed, 120 VAC	each	26161-00
Blender, 2-speed, 240 VAC	each	26161-02
DRB200 Reactor, 115 V, 21x13 mm + 4x20 mm (dual block)	each	DRB200-02
DRB200 Reactor, 115 V, 15x13 mm + 15x13 mm (dual block)	each	DRB200-03
DRB200 Reactor, 115 V, 12x13 mm + 8x20 mm (dual block)	each	DRB200-04
DRB200 Reactor, 230 V, 21x13mm + 4x20 mm (dual block)	each	DRB200-06
DRB200 Reactor, 230 V, 15x13mm + 15x13 mm (dual block)	each	DRB200-07
DRB200 Reactor, 230 V, 12x13mm + 8x20 mm (dual block)	each	DRB200-08
Stir Plate, magnetic	each	28812-00
Stir Bar, octagonal	each	20953-52
Sulfuric Acid, ACS	500 mL	979-49
TNTplus™ Reactor adapter sleeves, 16-mm to 13-mm diameter	5/pkg	28958-05



FOR TECHNICAL ASSISTANCE, PRICE INFORMATION AND ORDERING:

In the U.S.A. – Call toll-free 800-227-4224
Outside the U.S.A. – Contact the HACH office or distributor serving you.
On the Worldwide Web – www.hach.com; E-mail – techhelp@hach.com

HACH COMPANY
WORLD HEADQUARTERS
Telephone: (970) 669-3050
FAX: (970) 669-2932

Oxygen Scavengers

Iron Reduction Method for Oxygen Scavengers

Method 8140

Powder Pillows

5 to 600 µg/L carbohydrazide;
3 to 450 µg/L DEHA;
9 to 1000 µg/L hydroquinone;
13 to 1500 µg/L iso-ascorbic acid [ISA];
15 to 1000 µg/L methylethyl ketoxime [MEKO]

Scope and Application: For testing residual corrosion inhibitors (oxygen scavengers) in boiler feed water or condensate



Test Preparation

Before starting the test:

Analyze samples immediately. Do not preserve for later analysis.

The sample temperature should be 25 ± 3 °C (77 ± 5 °F).

Soak glassware with 1:1 hydrochloric acid solution. Rinse several times with deionized water. These two steps will remove iron deposits that can cause slightly high results.

To determine ferrous iron concentration, repeat the procedure, but do not add DEHA Reagent 2. Correct for the ferrous iron concentration: **OPTIONS>MORE>REAGENT BLANK>ON**. The reading attributed to the ferrous iron concentration will appear.

Collect the following items

Quantity

Collect the following items	Quantity
Bottle, glass mixing, with 25-mL mark	2
DEHA Reagent 1 Powder Pillow	2
DEHA Reagent 2 Solution	1 mL
Deionized Water	25 mL
Dropper, 0.5 and 1.0 mL marks	1
Hydrochloric Acid, 1:1, 6.0 N	varies
Sample Cells, 1-inch square, 10-mL	2

Note: Reorder information for consumables and replacement items is on page 4.

Powder Pillows

Method 8140



1. Press **STORED PROGRAMS**.

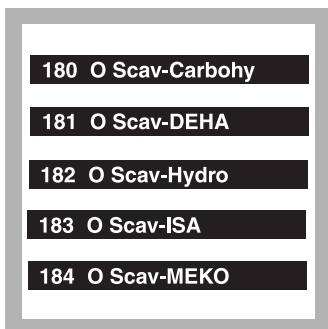

2. Select one of the tests.



3. Press **START**.

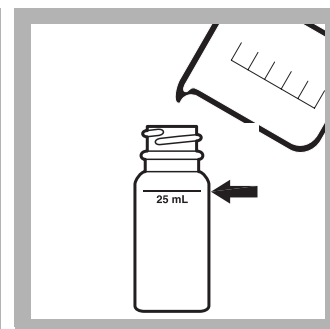

4. **Prepared Sample:** Fill a mixing bottle with 25 mL of sample.

When determining oxygen scavengers that react quickly with oxygen at room temperature, cap the bottle.

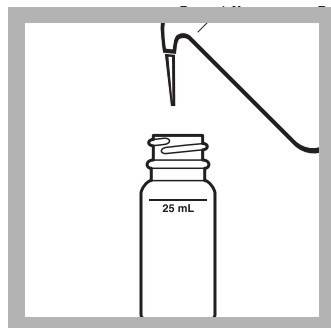

5. **Blank Preparation:** Fill a second cell bottle 25 mL of deionized water.

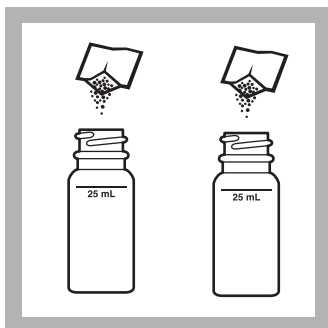

6. Add the contents of one DEHA Reagent 1 Powder Pillow to each mixing bottle. Swirl to mix.

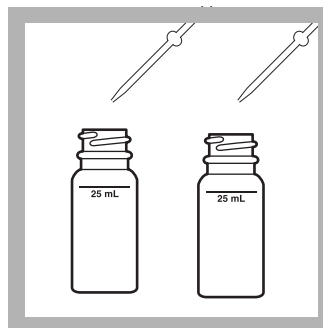

7. Add 0.5 mL of DEHA Reagent 2 Solution to each bottle. Mix. Place both sample cells in the dark.

A purple color will develop if an oxygen scavenger is present.

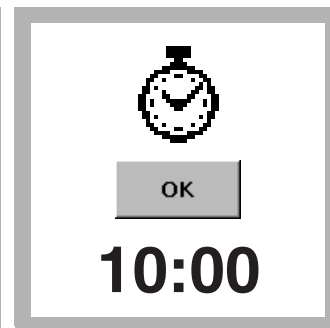

8. Press **TIMER>OK**.

A ten-minute reaction period (or a **two-minute** reaction period for **hydroquinone**) will begin.

Keep the sample cells in the dark during the reaction period.



9. When the timer expires, transfer the blank and prepared samples into square sample cells.

10. Immediately after transferring to the 10-mL cell, wipe the blank and insert it into the cell holder with the fill line facing right. Close the cover. Press **ZERO**.

For greater accuracy, read the result immediately after the timer expires.

11. Immediately wipe the prepared sample and insert it into the cell holder with the fill line facing right.

12. Press **READ**.
Results are in µg/L.

Interferences

Table 1 Interfering Substances and Levels

Interfering Substance	Interference Levels and Treatments
Borate (as Na ₂ B ₄ O ₇)	Greater than 500 mg/L
Cobalt	Greater than 0.025 mg/L
Copper	Greater than 8.0 mg/L
Ferrous Iron	All levels
Hardness (as CaCO ₃)	Greater than 1000 mg/L
Light	Light may interfere. Keep sample cells in the dark during color development.
Lignosulfonates	Greater than 0.05 mg/L
Manganese	Greater than 0.8 mg/L
Molybdenum	Greater than 80 mg/L
Nickel	Greater than 0.8 mg/L
Phosphate	Greater than 10 mg/L
Phosphonates	Greater than 10 mg/L
Sulfate	Greater than 1000 mg/L
Temperature	Sample temperatures below 22 °C or above 28 °C (72 °F or 82 °F) may affect test accuracy.
Zinc	Greater than 50 mg/L

Substances which reduce ferric iron will interfere. Substances which complex iron strongly may also interfere.

Sample Collection, Preservation, and Storage

Collect samples in clean, dry, plastic or glass containers. Avoid excessive agitation or exposure to sunlight when sampling. Rinse the container several times with the sample. Allow the container to overflow and cap the container so that there is no headspace above the sample. Rinse the sample cell several times with sample, then carefully fill to the 25-mL mark. Perform the analysis immediately.

Summary of Method

Diethylhydroxylamine (DEHA) or other oxygen scavengers present in the sample react with ferric iron in DEHA Reagent 2 Solution to produce ferrous ion in an amount equivalent to the DEHA concentration. This solution then reacts with DEHA 1 Reagent, which forms a purple color with ferrous iron proportional to the concentration of oxygen scavenger. Test results are measured at 562 nm.

Consumables and Replacement Items

Required Reagents

Description	Quantity/Test	Unit	Cat. No.
Oxygen Scavenger Reagent Set, includes:	—	—	24466-00
(2) DEHA Reagent 1 Powder Pillows	2	100/pkg	21679-69
(1) DEHA Reagent 2 Solution	1 mL	100 mL	21680-42
Hydrochloric Acid, 1:1, 6.0 N	varies	500 mL	884-49
Water, deionized	25 mL	4 L	272-56

Required Apparatus

Description	Quantity/Test	Unit	Cat. No.
Bottle, glass mixing, with 25-mL mark	2	each	17042-00
Dropper, 0.5 and 1.0-mL marks	1	20/pkg	21247-20
Sample Cells, 10-20-25 mL, with caps	2	6/pkg	24019-06
Sample Cells, 1-inch square glass, 10 mL, matched pair	2	2/pkg	24954-02



FOR TECHNICAL ASSISTANCE, PRICE INFORMATION AND ORDERING:
In the U.S.A. – Call toll-free 800-227-4224
Outside the U.S.A. – Contact the HACH office or distributor serving you.
On the Worldwide Web – www.hach.com; E-mail – techhelp@hach.com

HACH COMPANY
WORLD HEADQUARTERS
Telephone: (970) 669-3050
FAX: (970) 669-2932

Method 8311

Indigo Method

AccuVac® Ampul

LR (0.01 to 0.25 mg/L O₃),
MR (0.01 to 0.75 mg/L O₃),
HR (0.01 to 1.50 mg/L O₃)

Scope and Application: For water



Test Preparation

Before starting the test:

Analyze sample immediately. Do not preserve for later analysis.

Use tap water or deionized water for the blank (ozone-free water)

The sequence of measuring the blank and the sample is reversed in this procedure.

Collect the following items:

Quantity

Select Ozone AccuVac® Ampuls based on range:

0–0.25 mg/L

2

0–0.75 mg/L

2

0–1.50 mg/L

2

Beaker, Polypropylene, 50-mL, low form with pour spout

1

Water, ozone-free

varies

Note: Reorder information for consumables and replacement items is on page 3.

AccuVac Ampul

Method 8311

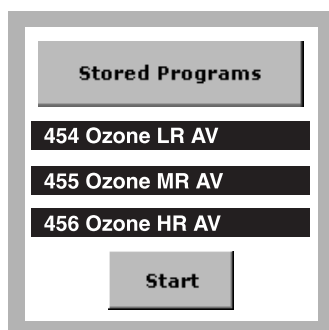

1. Select the test.

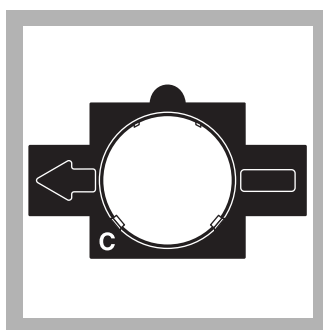

2. Insert Adapter C.

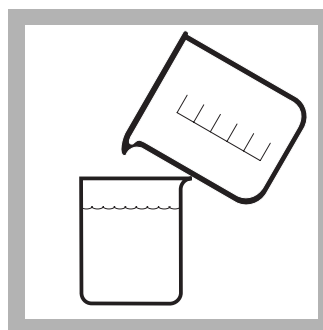

3. **Blank Preparation:**
Collect at least 40 mL of ozone-free water in a 50-mL beaker.

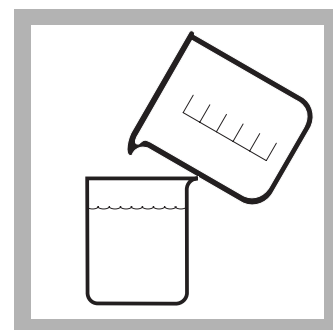

4. **Prepared Sample:**
Gently collect at least 40 mL of sample in another 50-mL beaker.

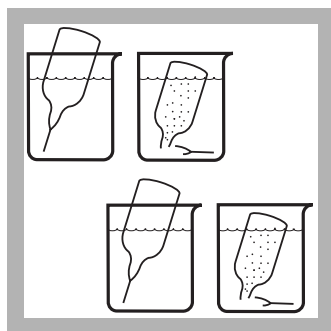

5. Fill one Indigo Ozone Reagent AccuVac Ampul with the sample and another with the blank.

Keep the tip immersed while the Ampul fills.



6. Quickly invert both Ampuls several times to mix.

Some of the blue color will be bleached if ozone is present.

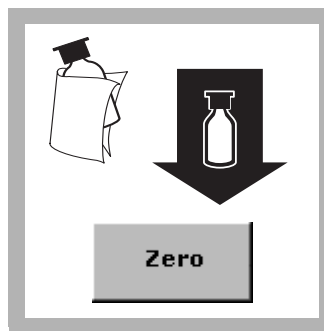

7. Wipe the Ampuls with a cloth to remove fingerprints or other marks.

Insert the sample into the cell holder.

Press **ZERO**.

The display will show:

0.00 mg/L O₃



8. Insert the blank into the cell holder.

Press **READ**. Results are in mg/L O₃.

Sample Collection, Storage, and Preservation

The most important consideration when collecting a sample is to prevent the escape of ozone from the sample. The sample should be collected gently and analyzed immediately. Warming the sample, or disturbing the sample by stirring or shaking, will result in ozone loss. After collecting the sample, do not transfer it from one container to another unless absolutely necessary.

Stability of Indigo Reagent

Because indigo is light-sensitive, the AccuVac Ampuls should be kept in the dark at all times. The indigo solution, however, decomposes slowly under room light after filling with sample. The blank Ampul can be used for multiple measurements during the same day.

Summary of Method

The reagent formulation adjusts the sample pH to 2.5 after the Ampul has filled. The indigo reagent reacts immediately and quantitatively with ozone. The blue color of indigo is bleached in proportion to the amount of ozone present in the sample. Other reagents in the formulation prevent chlorine interference. No transfer of sample is needed in the procedure, therefore ozone loss due to sampling is eliminated. Test results are measured at 600 nm.

Consumables and Replacement Items

Required Reagents

Description	Quantity/Test	Unit	Cat. No.
Select one or more Ozone AccuVac® Ampuls based on range:			
0–0.25 mg/L	2	25/pkg	25160-25
0–0.75 mg/L	2	25/pkg	25170-25
0–1.5 mg/L	2	25/pkg	25180-25

Required Apparatus (AccuVac)

Description	Unit	Cat. No.
Adapter, 1-inch round, for AccuVac Ampuls	1	each
Polypropylene Beaker, 50-mL, Low Form, with pour spout	each	1080-41

Optional Reagents and Apparatus

Description	Unit	Cat. No.
Snapper, AccuVac®	each	24052-00
Water, demineralized	4 L	272-56



FOR TECHNICAL ASSISTANCE, PRICE INFORMATION AND ORDERING:

In the U.S.A. – Call toll-free 800-227-4224
Outside the U.S.A. – Contact the HACH office or distributor serving you.
On the Worldwide Web – www.hach.com; E-mail – techhelp@hach.com

HACH COMPANY
WORLD HEADQUARTERS
Telephone: (970) 669-3050
FAX: (970) 669-2932

PCB (Polychlorinated Biphenyls)

Method 10050

Immunoassay Method¹

Scope and Application: For soil

¹ This test is semi-quantitative. Results are expressed as greater or less than the threshold value used.



Test Preparation

This method analyzes for PCB that has been extracted from soil samples. Sample extracts, calibrators, and reagents are added to cuvettes coated with PCB-specific antibodies. The color that develops is then measured and compared with the color measurements of the calibrators. The test requires about 20 minutes for complete analysis. As many as 10 cuvettes can be run simultaneously.

Before starting the test:

Read the entire procedure before starting. Identify and make ready all the necessary reagents, cuvettes, and other apparatus before beginning the analysis.

Timing is critical; follow instructions carefully.

A consistent technique when mixing the cuvettes is critical to this test. The best results come from using the cuvette rack and mixing as described in [Using the 1-cm MicroCuvette Rack on page 6](#). Cuvettes can be mixed individually, but test results may not be as consistent.

Handle the cuvettes carefully. Scratches on the inside or outside may cause erroneous results. Carefully clean the outside of the cuvettes with a clean absorbent cloth or tissue before placing them into the instrument.

Antibody cuvettes and enzyme conjugate are made in matched lots. Do not mix reagent lots.

To avoid damaging the Color Developing Solution, do not expose it to direct sunlight.

There are two protocols in this procedure, one for levels of 1 ppm and 5 ppm, and another for 10 ppm and 50 ppm. Each uses a different quantity of calibrator and sample extract See [PCB Protocols on page 5](#) for more information.

Store the reagents at 4 °C when they are not in use. Allow the reagents to reach room temperature before using them in an analysis. Actual testing may be done at temperatures ranging from 1– 38 °C.

The Soil Extractant contains methyl alcohol which is poisonous and flammable. Before using this and other reagents, read the Material Safety Data Sheet (MSDS) for proper use of protective equipment and other safety information.

Protective nitrile gloves are recommended for this procedure.

Collect the following items

Quantity

PCB Reagent Set	1
Water, deionized	varies
Caps, flip spout	1
Marker, laboratory	1
Rack, for 1-cm Micro Cuvettes	1
Wipes, disposable	1
Pipet, TenSette®, 0.1–1.0 mL and pipet tips	1
Soil Extraction Kit and Soil Scoop	1

Note: Reorder information for consumables and replacement items is on [page 9](#).

Soil Extraction Procedure

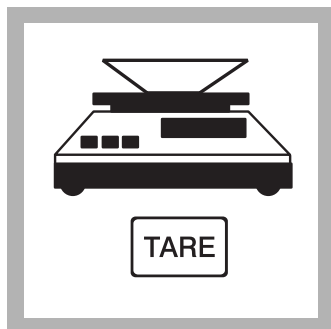

1. Weigh out 5 g of soil in the plastic weighing boat.

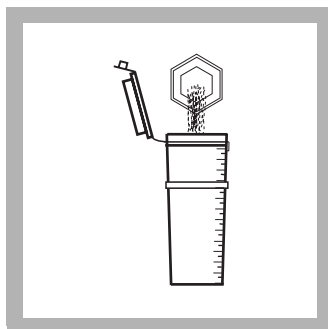

2. Carefully pour the soil into an extraction vial.



3. Use the 5-gram scoop to add one scoop of sodium sulfate to the extraction vial.



4. Use the graduated cylinder to transfer 10 mL of Soil Extractant into the extraction vial.

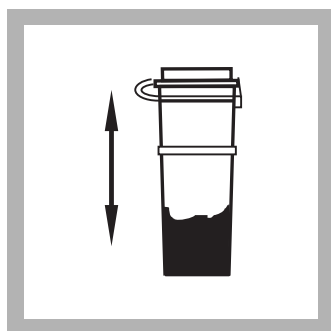

5. Cap the extraction vial tightly and shake vigorously for one minute.



6. Allow to settle for at least one minute. Carefully open the extraction vial.

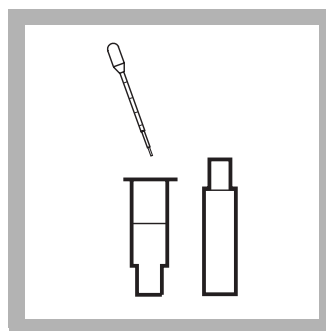

7. Using the disposable bulb pipet, withdraw 1.0–1.5 mL from the liquid layer at the top of the extraction vial.

Transfer it into the filtration barrel (the bottom part of the filtering assembly into which the plunger inserts).

Do not use more than 1.5 mL. The bulb is marked in 0.25-mL increments.

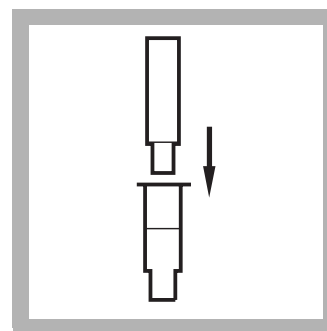

8. Insert the filtration plunger into the filtration barrel. Press firmly on the plunger until the sample extract is forced upward into the center of the plunger.

Use the resultant filtrate for the immunoassay in the [Immunoassay for Soil Extracts on page 3](#).

It may be necessary to place the filtration assembly on a table and press down on the plunger.

Immunoassay for Soil Extracts

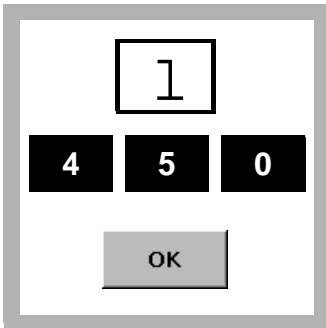

1. Press
SINGLE WAVELENGTH

Press **OPTIONS** and press the λ button. Type in

450 nm and press **OK**.

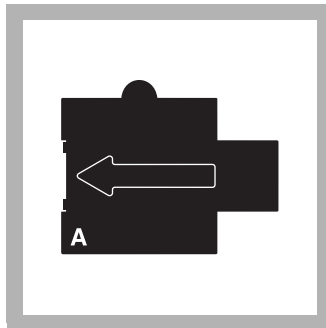

2. Insert Adapter A.

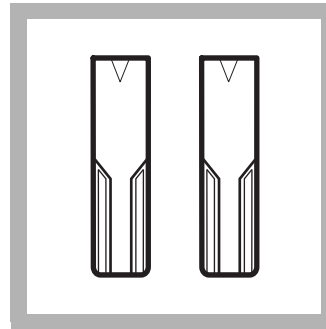

3. Label an Antibody Cuvette for each calibrator and each sample to be tested.

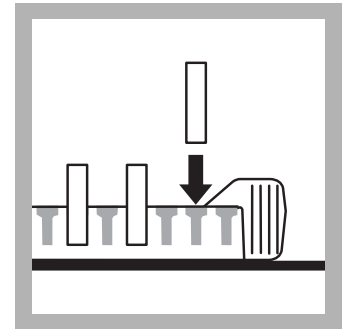

4. Insert the cuvettes into the rack snugly.

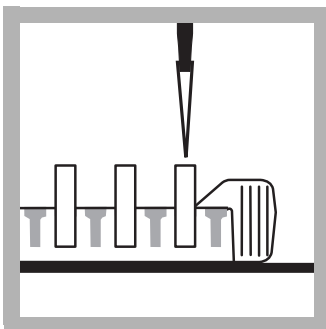

5. Pipet 0.5 mL of each Diluent Solution into the appropriately labeled cuvette.

Use a new pipette tip for each calibrator.

Important Note: Have the necessary apparatus at hand for the next four steps; they must be done without delay.

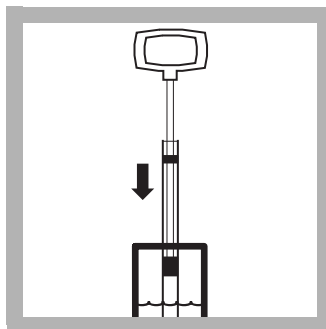

6. Use a Wiretrol[®] pipet to transfer the appropriate volume of calibrator or sample extract into each cuvette (see [Table 1 on page 5](#)).

Use a separate capillary tube for each solution.

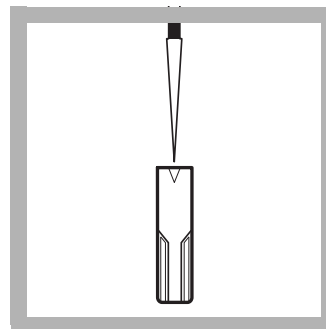

7. Immediately pipet 0.5 mL of PCB Enzyme Conjugate into each calibrator and sample cuvette. The same pipette tip can be used to add the enzyme conjugate to each cuvette.

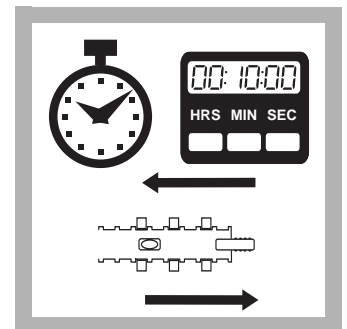

8. Press **OPTIONS**. Press **TIMER**. Enter 10:00 minutes and press **OK**.

A 10-minute reaction time will begin. Immediately begin mixing the cuvettes for 30 seconds. See [Using the 1-cm MicroCuvette Rack on page 6](#).

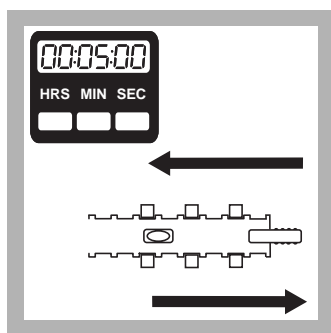

9. After 5 minutes mix the contents of the rack for 30 seconds (Using the [1-cm MicroCuvette Rack on page 6.](#))

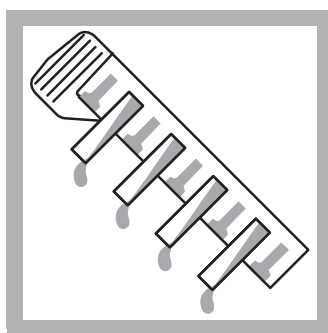

10. At the end of the 10-minute period, discard the contents of all the cuvettes into an appropriate waste container.

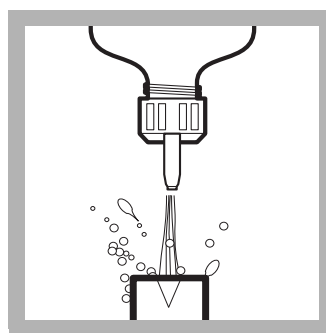

11. Wash each cuvette forcefully and thoroughly four times with deionized water. Empty the rinse water into the waste container.

Ensure that most of the water is drained from the cuvettes by turning the cuvettes upside down and tapping them lightly on a paper towel.

Color Development

Important Note: Timing is critical. Follow instructions carefully.

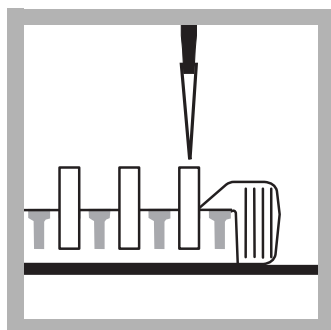

12. With the cuvettes still held snugly in the rack, pipet 0.5 mL of Color Developing Solution into each Antibody Cuvette.

Use a new pipette tip for each cuvette.

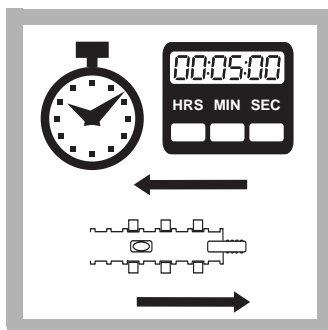

13. Press **OPTIONS**. Press **TIMER**. Enter 05:00 minutes and press **OK**.

A reaction period will begin. Mix, using the instructions in [Using the 1-cm MicroCuvette Rack on page 6.](#)

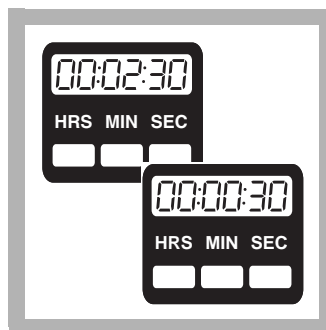

14. After 2.5 minutes, mix the contents of the rack a second time for a period of 30 seconds using the same technique.

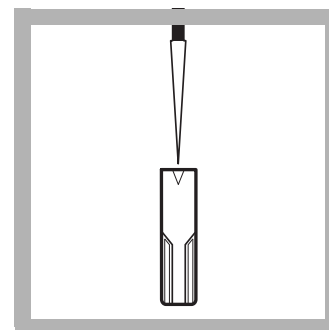

15. At the end of the 5-minute reaction period, pipette 0.5 mL of Stop Solution into each cuvette in the same order as the Color Developing Solution was added in step 12. Use the same pipette tip repeatedly for this step.

Slide the rack for 20 seconds (Using the [1-cm MicroCuvette Rack on page 6.](#))

Blue solutions will turn yellow with the addition of the Stop Solution.

Measuring the Color

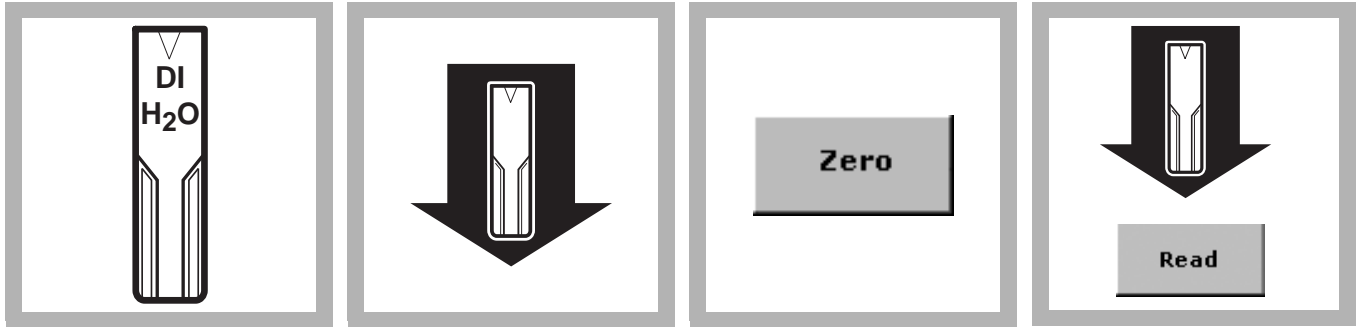

16. Label and fill a Zeroing Cuvette with deionized water. Wipe the outside of all the cuvettes with a tissue to remove water, smudges, and fingerprints.

17. Insert the filled zeroing cuvette into the cell holder with the arrow pointing to the right. Orient the arrow in the same direction for all cuvettes.

18. Press **ZERO**.
The display will show:
0.000 Abs

19. Insert the first calibrator into the cell holder.
Press **READ**. The display will give an absorbance reading. Record the results for each calibrator and sample.
Repeat this step for all remaining calibrators and samples.
See [Interpreting and Reporting Results on page 7](#) for help with interpretation of results.

PCB Protocols

There are two protocols in this procedure, one for levels of 1 ppm and 5 ppm, and another for 10 ppm and 50 ppm. Each uses a different quantity of calibrator and sample extract ([Table 1](#)).

Table 1 PCB Protocols

Range (as Arochlor 1248)	Volume of calibrator and sample extract used
1 ppm and 5 ppm	50 µL
10 ppm and 50 ppm	10 µL

To test across ranges, such as 1 and 50 ppm, test the lower concentration first. If the result is positive then test at the higher level. If the result of the test at the lower concentration is negative, the higher range test will be negative also, and need not be performed.

The same filtered extract can be used for both protocols if it is tightly capped between assays. The maximum time between assays cannot exceed one-half hour.

Using the Wiretrol®* Pipet

The Wiretrol Pipet can accurately measure small quantities of liquids. It consists of two parts: a Teflon®-tipped plunger and a calibrated capillary tube. The plunger can be reused; the capillary tubes must be discarded after one use.

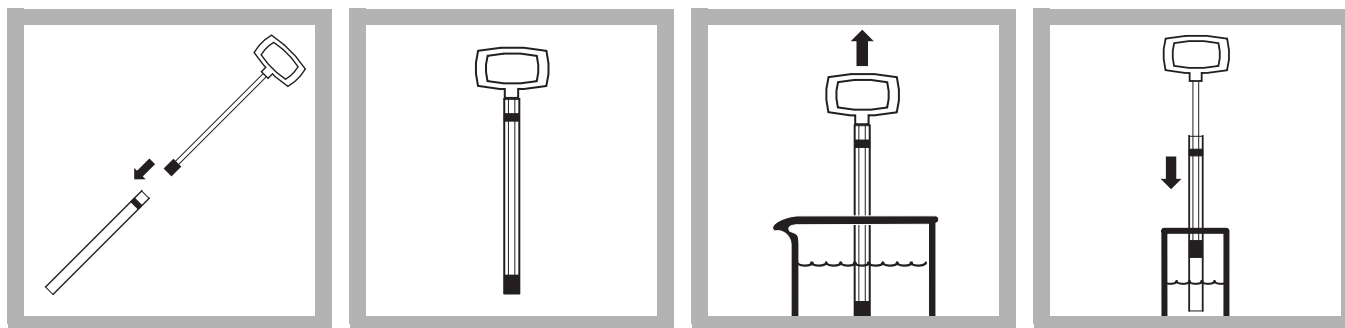

1. Wet the orange Teflon® tip of the Wiretrol plunger in the sample and carefully insert it into the end of the capillary tube with the colored band.

2. Push the tip to the other end of the capillary tube until it barely extends beyond the end of the capillary tube.

3. Submerge the capillary tube below the surface of the liquid to be pipetted. Slowly and smoothly draw the Wiretrol plunger up until the bottom of the plunger tips reaches the appropriate volume line.

4. To discharge the pipet, place the tip of the capillary tube below the surface of the solution and push the Wiretrol plunger down in one smooth motion. Change capillary tubes for each calibrator and sample.

Touch the end of the tube to the side of the vessel to release remaining drops on the capillary tube tip.

Using the 1-cm MicroCuvette Rack

This rack (Figure 1) has been designed specifically to aid in achieving precise and accurate results when using the immunoassay technique to analyze several samples at the same time.

Figure 1 The 1-cm MicroCuvette Rack

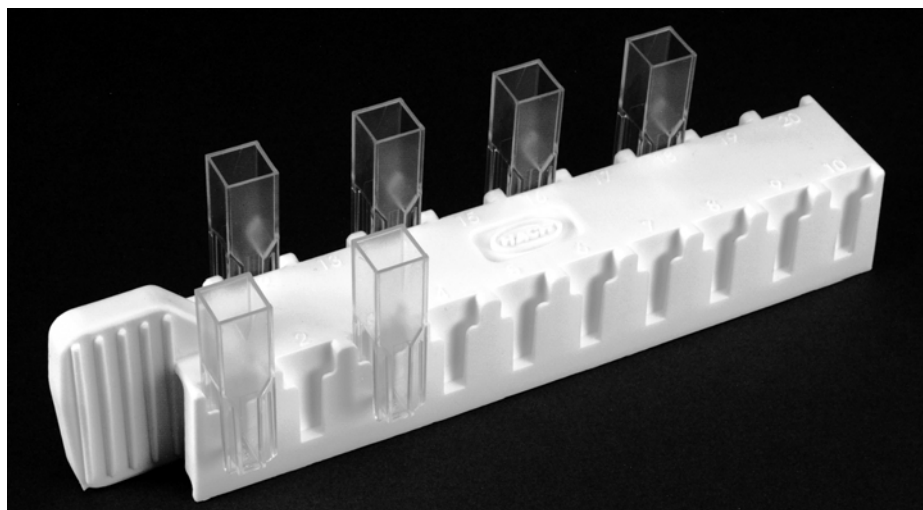

* Wiretrol is a registered trademark of Drummond Scientific.

Loading the Rack—The cuvette rack is designed so that it may be inverted with the cuvettes in place. Identify each cuvette with a sample or calibrator number and insert all the cuvettes in the rack before beginning the procedure. Fit the cuvettes snugly into the rack, but do not force them or they may be difficult to remove and their contents may spill. The cuvettes should remain in place when the rack is inverted and tapped lightly.

Mixing—Set the rack on a hard, flat surface that is at least twice the length of the rack. Hold the rack by one end and vigorously slide it back and forth along its long axis for 30 seconds. The rack should move through a distance equal to its own length in each direction.

Interpreting and Reporting Results

There is an inverse relationship between the concentration of PCB and the reading. In other words, the higher the reading, the lower the concentration of PCB.

Table 2 Relative PCB Concentration

If the sample reading is...	the sample PCB Concentration is...
...less than calibrator reading	...greater than the calibrator concentration
...greater than calibrator reading	...less than the calibrator concentration

Example Readings:

1 ppb PCB Calibrator: **0.775 Abs**

5 ppb PCB Calibrator: **0.430 Abs**

Sample #1: **0.200 Abs**

Sample #2: **0.600 Abs**

Sample #3: **0.900 Abs**

Interpretation for a Soil Sample

Sample #1—Sample reading is less than the readings for both calibrators. Therefore the sample concentration of PCB is greater than both 1 ppm and 5 ppm as Aroclor 1248.

Sample #2—Sample reading is between the readings for the 1 ppm and 5 ppm PCB calibrators. Therefore the sample concentration of PCB is between 1 ppm and 5 ppm as Aroclor 1248.

Sample #3—Sample reading is greater than the readings for both calibrators. Therefore the sample concentration of PCB is less than both 5 ppm and 1 ppm as Aroclor 1248.

Storing and Handling Reagents

- Wear protective gloves and eyewear.
- When storing reagent sets for extended periods of time, keep them out of direct sunlight. Store reagents at a temperature of 4 °C when not in use.
- Keep the foil pouch containing the Antibody Cuvettes sealed when not in use.
- If Stop Solution comes in contact with eyes, wash thoroughly for 15 minutes with cold water and seek immediate medical help.

Sensitivity

The PCB immunoassay cannot differentiate between the various Aroclors, but it detects their presence in differing degrees.

Table 3 Various PCBs in Soil

Compound	Concentration (ppm) to give a positive result at			
	1 ppm	5 ppm	10 ppm	50 ppm
1248	1	5	10	50
1016	2	9	20	67
1242	1.2	6	14	50
1254	1.4	4.6	11	28
1260	1.1	4.9	11	38

Table 4 Compounds Not Detectable At 1000 ppm

Biphenyl	2,4,6-trichlorophenyl	1,3-dichlorobenzene
2,4-dichlorophenyl	pentachlorophenol	1,4-dichlorobenzene
2,4,5-trichlorophenyl	1,2-dichlorobenzene	1,2,4-trichlorobenzene

Sample Collection and Storage

Analyze the samples as soon as possible after collection. If the samples must be stored, collect them in glass or Teflon® containers that have been washed with soap and water and rinsed with methanol. The container should be capped with a Teflon-lined cap. If a Teflon cap is not available, aluminum foil rinsed in methanol may be used as a substitute cap liner.

Summary of Method

Immunoassay tests use antigen/antibody reactions to test for specific organic compounds in water and soil. Antibodies specific for PCB are attached to the walls of plastic cuvettes. They selectively bind and remove PCB from complex sample matrices. A prepared sample and a reagent containing enzyme-conjugate molecules (analyte molecules attached to molecules of an enzyme) are added to the Antibody Cuvettes. During incubation, enzyme-conjugate molecules and PCB compete for binding sites on the antibodies. Samples with higher levels of analyte will have more antibody sites occupied by PCB and fewer antibody sites occupied by the enzyme-conjugate molecules.

After incubation, the sample and unbound enzyme conjugate are washed from the cuvette and a color-development reagent is added. The enzyme in the conjugate catalyzes the development of color. Therefore, there is an inverse relationship between color intensity and the amount of PCB in the sample. The resulting color is then compared with a calibrator to determine whether the PCB concentration in the sample is greater or less than the threshold levels. The PCB concentration is inversely proportional to the color development: the lighter the color, the higher the PCB concentration. Test results are measured at 450 nm.

Consumables and Replacement Items

Required Reagents

Description	Unit	Cat. No.
PCB Reagent Set ¹	20 cuvettes	27735-00
Deionized Water	500 mL	242-49

¹ Immunoassay components are manufactured by Beacon Analytical Systems, Inc.

Required Apparatus

Description	Unit	Cat. No.
Adapter, 1-cm square cell	each	
Caps, flip spout	2/pkg	25818-02
Marker, laboratory	each	20920-00
Rack, for 1-cm Micro Cuvettes	each	48799-00
Wipes, disposable	box	20970-00
Pipet, TenSette®, 0.1–1.0 mL	each	19700-01
Pipet Tips, for TenSette Pipet 19700-01	1000/pkg	21856-28

Soil Extraction Reagents and Apparatus

Description	Unit	Cat. No.
Soil Scoop, 5-g, 4.25-cc	each	26572-05
Soil Extraction Refill Kit, includes:	each	27752-00
Dropper, LDPE, 0.5 and 1.0-mL	20/pkg	21247-20
Filter and Barrel Assembly	20/pkg	25676-20
Sodium Sulfate, anhydrous	250 g	7099-29
Soil Extractant Solution	200 mL	25677-29
Soil Sample Container	20/pkg	25929-20
Weighing Boat, 8.9-cm square	20/pkg	21790-20
Spatula, disposable	2/pkg	25693-20

Optional Reagents and Apparatus

Description	Cat. No.
Gloves, disposable nitrile, medium ¹	25505-02
Pipet Tips, for TenSette Pipet 19700-01	21856-96

¹ Other sizes available.



FOR TECHNICAL ASSISTANCE, PRICE INFORMATION AND ORDERING:

In the U.S.A. – Call toll-free 800-227-4224
Outside the U.S.A. – Contact the HACH office or distributor serving you.
On the Worldwide Web – www.hach.com; E-mail – techhelp@hach.com

HACH COMPANY
WORLD HEADQUARTERS
Telephone: (970) 669-3050
FAX: (970) 669-2932

Scope and Application: For water and wastewater; USEPA accepted (distillation required)²

¹ Adapted from *Standard Methods for the Examination of Water and Wastewater*

² Procedure is equivalent to USEPA method 420.1 for wastewater



Test Preparation

Before starting the test:

Analyze samples within four hours to avoid oxidation.

Spilled reagent affects test results and is hazardous to skin and other materials.

Use chloroform only with proper ventilation.

Phenol 2 Reagent Powder Pillows contain potassium ferricyanide. Both chloroform (D022) and cyanide (D001) solutions are regulated as hazardous waste by the Federal RCRA. **Do not pour these materials down the drain.** Chloroform solutions and the cotton plug used in the delivery tube of the separatory funnel should be collected for disposal as a reactive waste. Be sure that cyanide solutions are stored in a caustic solution with a pH >11 to prevent release of hydrogen cyanide gas. Refer to a current MSDS for safe handling and disposal information.

In bright light conditions (e.g. direct sunlight) it may be necessary to close the cell compartment with the protective cover during measurements.

Collect the following items:

Quantity

Collect the following items:	Quantity
Chloroform, ACS	60 mL
Clippers	1
Cotton Balls	1
Cylinder, graduated, 50-mL	1
Cylinder, graduated, 500-mL	1
Funnel, separatory, 500-mL	2
Hardness 1 Buffer Solution, pH 10.1	10 mL
Phenol 2 Reagent Powder Pillows	2
Phenol Reagent Powder Pillows	2
Pipet, volumetric, Class A, 5.00-mL	1
Ring, support, 4-inch	2
Sample Cells, 1-inch square, 25-mL, stoppered, matched pair	1
Support for Ring Stand, 5 x 8 inch base	1
Water, deionized	300 mL

Note: Reorder information for consumables and replacement items is on page 5.

4-Aminoantipyrine

Method 8047



1. Press
STORED PROGRAMS.

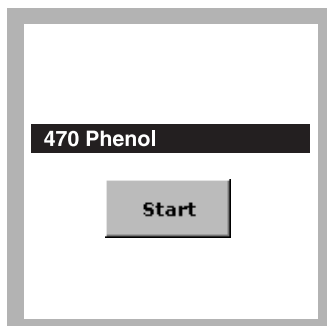

2. Select the test.

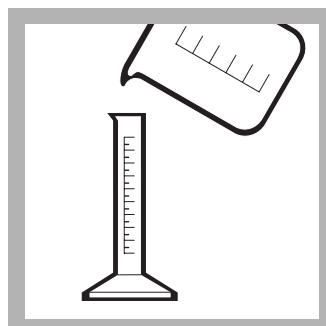

3. Measure 300 mL of deionized water in a 500-mL graduated cylinder.

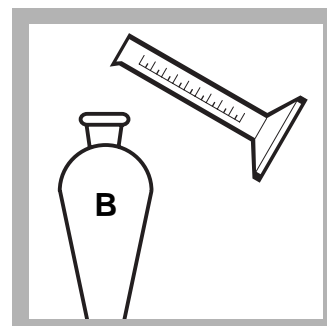

4. **Blank Preparation:**
Pour the measured deionized water into a 500-mL separatory funnel.

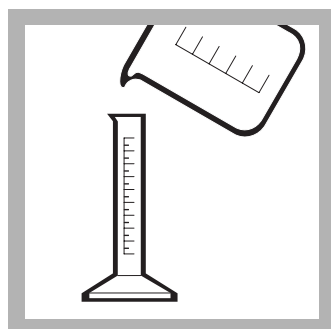

5. Measure 300 mL of sample in a 500-mL graduated cylinder.

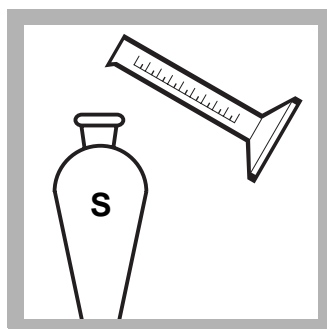

6. **Prepared Sample:**
Pour the measured sample into another 500-mL separatory funnel.

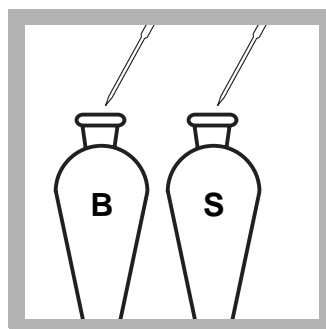

7. Add 5 mL of Hardness Buffer to each separatory funnel. Stopper and shake to mix.

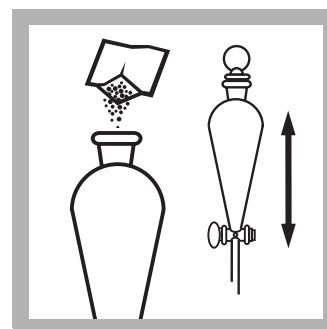

8. Add the contents of one Phenol Reagent Powder Pillow to each separatory funnel. Stopper and shake to dissolve.

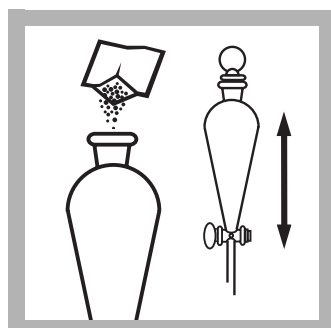

9. Add the contents of one Phenol 2 Reagent Powder Pillow to each separatory funnel. Stopper and shake to dissolve.

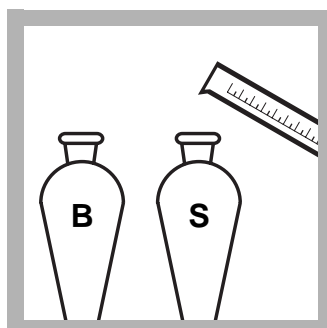

10. Add 30 mL of chloroform to each separatory funnel. Stopper each funnel.

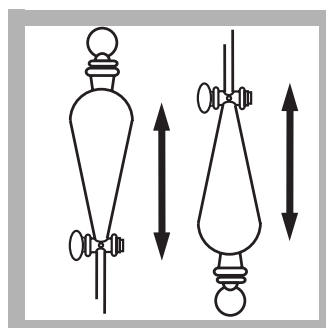

11. Invert each funnel and temporarily vent. Shake each funnel briefly and vent. Then vigorously shake each funnel for a total of 30 seconds (venting if necessary).

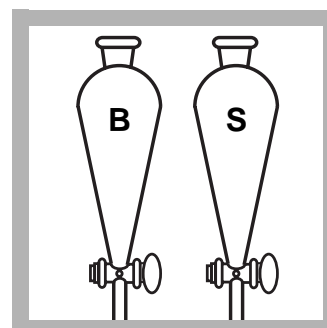

12. Remove the stoppers. Allow both funnels to stand until the chloroform settles to the bottom of the funnel. The chloroform layer will be yellow to amber if phenol is present.

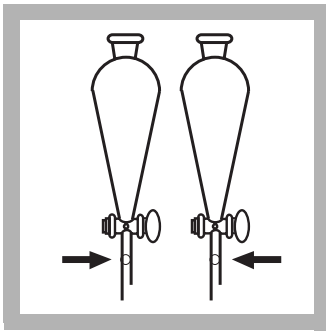

13. Insert a large, pea-sized cotton plug into the delivery tube of each funnel.

Filtering the chloroform layer through the cotton removes suspended water or particles. The volume of chloroform extract will be about 25 mL.

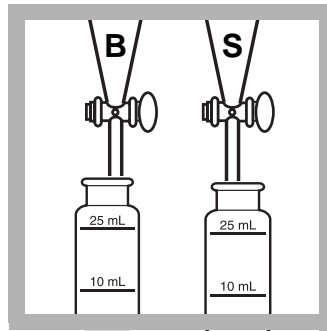

14. Drain the chloroform layers into separate sample cells (one for the blank and one for each sample).

Stopper the cells.

The water phase contains chloroform, which is hazardous. Dispose of properly.

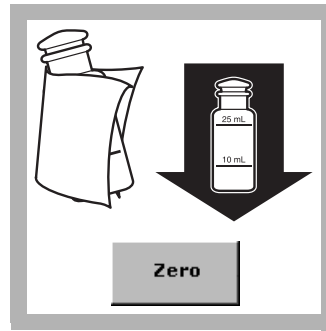

15. Wipe the blank and insert it into the cell holder with the fill line facing right.

Press **ZERO**.

The display will show:
0.000 mg/L Phenol

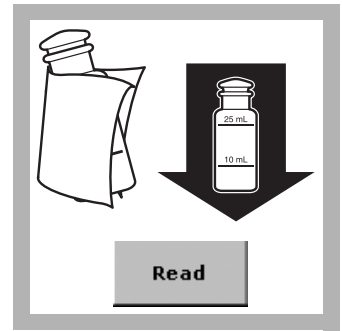

16. Wipe the prepared sample and insert it into the cell holder with the fill line facing right.

Press **READ**. Results are in mg/L Phenol.

Interferences

Table 1 Interfering Substances and Levels

Interfering Substance	Interference Levels and Treatments
pH	The sample pH must be between 3 and 11.5 for best results.
Oxidizing or reducing agents	May interfere. Distill samples (see procedure below).
Sulfides or suspended matter	<ol style="list-style-type: none"> 1. Distillation or the following pretreatment is necessary: 2. Fill a clean 500-mL graduated cylinder with 350 mL of sample. Pour the sample into a clean 500-mL Erlenmeyer flask. 3. Add the contents of one Sulfide Inhibitor Reagent Powder Pillow¹. Swirl to mix. 4. Filter 300 mL of the sample through a folded filter paper¹. Use this solution in step 5.

¹ See [Distillation Reagents and Apparatus on page 5](#).

Sample Collection, Storage, and Preservation

Most reliable results are obtained when samples are analyzed within four hours after collection. Use the following storage instructions only if prompt analysis is not possible. Collect 500 mL of sample in clean glass containers and add the contents of two Copper Sulfate Powder Pillows*. Adjust the pH to 4 or less with 10% Phosphoric Acid Solution*. Store at 4 °C (39 °F) or lower and analyze within 24 hours.

Accuracy Check

Standard Solution Method

For greater accuracy, analyze standard solutions when new lots of reagent are first used.

1. Weigh out 1.00 g of Phenol, ACS. Transfer to a 1000-mL volumetric flask. Dilute to the mark with freshly boiled and cooled deionized water. This is a 1000-mg/L stock solution.

* See [Distillation Reagents and Apparatus on page 5](#).

2. Pipet 10.0 mL of the 1000-mg/L stock solution to a 1000-mL volumetric flask. Dilute to the mark with deionized water. This is a 10-mg/L working solution.
3. Prepare a 0.200-mg/L standard solution by pipetting 10.0 mL of the working solution into a 500-mL volumetric flask. Dilute to the mark with deionized water.
4. Perform the phenol procedure described above using the prepared standard.
5. To adjust the calibration curve using the reading obtained with the standard solution, press **OPTIONS>MORE** on the current program menu. Press **STANDARD ADJUST**.
6. Press **ON**. Press **ADJUST** to accept the displayed concentration. If an alternate concentration is used, press the number in the box to enter the actual concentration, then press **OK**. Press **ADJUST**.

Distillation

Sample distillation as described in the following steps will eliminate interferences. The sample pH must be between 3 and 11.5 for the best results. See [Interferences on page 3](#) for pretreatment guidelines.

1. Set up the Distillation Apparatus* by assembling the general purpose apparatus as shown in the Distillation Apparatus Manual. Use the 500-mL Erlenmeyer flask to collect the distillate. It may be necessary to use a laboratory jack to elevate the flask.
2. Place a stirring bar into the flask.
3. Measure 300 mL of water sample in a clean 500-mL graduated cylinder. Pour it into the distillation flask.
4. For proof of accuracy, use a 0.200-mg/L phenol standard (see [Accuracy Check](#)) in addition to the sample.
5. Using a serological pipet, add 1 mL of Methyl Orange Indicator* to the distillation flask.
6. Turn on the stirrer power switch. Set the stir control to 5.
7. Add 10% Phosphoric Acid Solution drop-wise until the indicator changes from yellow to orange.
8. Add the contents of one Copper Sulfate Powder Pillow* and allow to dissolve (omit this step if copper sulfate was used to preserve the sample). Cap the distillation flask.
9. Turn the water on and adjust it so a constant flow is maintained through the condenser. Set the heat control to 10.
10. Collect 275 mL of distillate in the Erlenmeyer flask, then turn the heat off.
11. Fill a 25-mL graduated cylinder to the 25-mL mark with deionized water. Add the water to the distillation flask.
12. Turn the still back on. Heat until another 25 mL of distillate is collected.
13. Using a clean graduated cylinder, re-measure the distillate to make sure 300 mL has been collected. The distillate is ready for analysis.

Summary of Method

The 4-aminoantipyrine method measures all ortho- and meta-substituted phenols. These phenols react with 4-aminoantipyrine in the presence of potassium ferricyanide to form a colored antipyrine dye. The dye is then extracted from the aqueous phase with chloroform and the color is measured at 460 nm. The sensitivity of the method varies with the type of phenolic compound. Because water samples may contain various types of phenolic compounds, the test results are expressed as the equivalent concentration of phenol.

* See [Distillation Reagents and Apparatus on page 5](#).

Consumables and Replacement Items

Required Reagents

Description	Quantity/Test	Unit	Cat. No.
Phenols Reagent Set (100 Tests), includes:	—	—	22439-00
(2) Chloroform, ACS	60 mL	4 L	14458-17
(3) Hardness 1 Buffer Solution, pH 10.1	10 mL	500 mL	424-49
(2) Phenol 2 Reagent Powder Pillows	2	100/pkg	1836-99
(2) Phenol Reagent Powder Pillows	2	100/pkg	872-99
Water, deionized	300 mL	4 L	272-56

Required Apparatus

Description	Quantity/Test	Unit	Cat. No.
Clippers	1	each	968-00
Cotton Balls	1	100/pkg	2572-01
Cylinder, graduated, 50-mL	1	each	508-41
Cylinder, graduated, 500-mL	1	each	508-49
Funnel, separatory, 500-mL	2	each	520-49
Pipet Bulb, safety	1	each	14651-00
Pipet, volumetric, Class A, 5.00-mL	1	each	14515-37
Ring, support, 4-inch	2	each	580-01
Sample Cells, 1-inch square, 25-mL, matched pair	2	2/pkg	26126-02
Support for Ring Stand, 5 x 8 inch base	2	each	563-00

Distillation Reagents and Apparatus

Description	Unit	Cat. No.
Balance, lab, 300 g x 0.01 g, 100–240 V	each	28018-01
Copper Sulfate Powder Pillows	50/pkg	14818-66
Distillation Heater and Support Apparatus, 115 VAC	each	22744-00
Distillation Heater and Support Apparatus, 230 VAC	each	22744-02
Distillation Apparatus Set, general purpose	each	22653-00
Filter Paper	—	1894-57
Flask, Erlenmeyer, 500 mL	each	505-49
Funnel	each	1083-67
Methyl Orange Indicator Solution, 0.5-g/L	100 mL MDB	148-32
Phenol, ACS	113 g	758-14
Phosphoric Acid Solution, 10%	100 mL MDB	14769-32
Sulfide Inhibitor Reagent Powder Pillows	100/pkg	2418-99



FOR TECHNICAL ASSISTANCE, PRICE INFORMATION AND ORDERING:

In the U.S.A. – Call toll-free 800-227-4224

Outside the U.S.A. – Contact the HACH office or distributor serving you.

On the Worldwide Web – www.hach.com; E-mail – techhelp@hach.com

HACH COMPANY
WORLD HEADQUARTERS
Telephone: (970) 669-3050
FAX: (970) 669-2932

Phosphonates

Method 8007

Persulfate UV Oxidation Method¹

Powder Pillows

(0.02 to 2.50 and 1.0 to 125.0 mg/L)

Scope and Application: For boiler and cooling water, wastewater, and seawater

¹ Adapted from Blystone, P., Larson, P., *A Rapid Method for Analysis of Phosphate Compounds*, International Water Conference, Pittsburgh, PA. (Oct 26-28, 1981)



Test Preparation

Before starting the test:

Clean glassware with 1:1 Hydrochloric Acid Solution¹, followed by a distilled water rinse. Do not clean glassware with commercial detergent.

Wear UV safety goggles while the UV lamp is on.

Do not handle the UV lamp surface. Fingerprints will etch the glass. Wipe the lamp with a soft, clean tissue between samples

The digestion in step 8 is normally completed in less than 10 minutes. However, contaminated samples or a weak lamp can cause incomplete phosphate conversion. Check conversion efficiency by running a longer digestion and seeing if the readings increase.

¹ See [Optional Reagents and Apparatus on page 6](#).

Collect the following items:

Quantity

Bottle, square, with 25-mL mark	1
Cylinder, mixing, graduated, 50-mL	1
Goggles, UV safety	
Pipet, serological, 10-mL	1
PhosVer® 3 Phosphate Reagent Powder Pillows	2
Potassium Persulfate Powder Pillow for Phosphonate	1
Safety bulb	1
Sample Cells, 1-square, 10-mL	2
Water, deionized	varies
UV Lamp with Power Supply	1

Note: Reorder information for consumables and replacement items is on [page 6](#).

Powder Pillows Method 8007

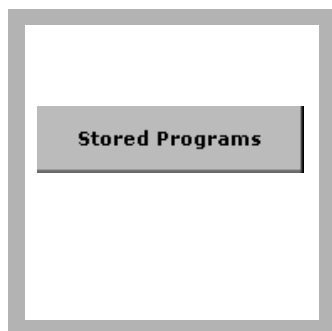

1. Press **STORED PROGRAMS**.

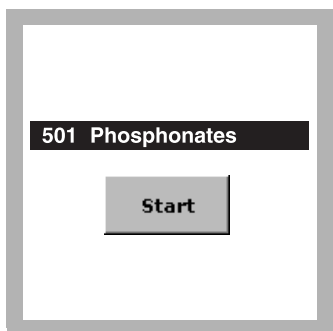

2. Select the test.

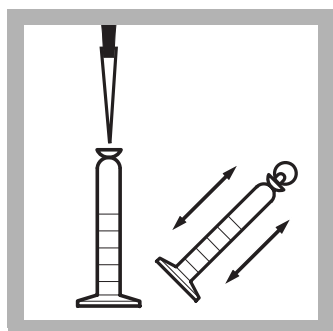

3. Choose the appropriate sample size from [Table 1 on page 4](#). Pipet the chosen volume into a 50-mL graduated cylinder. If necessary, dilute the sample to 50-mL with deionized water and mix well.

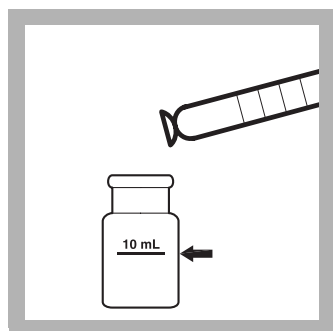

4. **Blank Preparation:** Fill a square sample cell to the 10-mL mark with diluted sample from step 3.

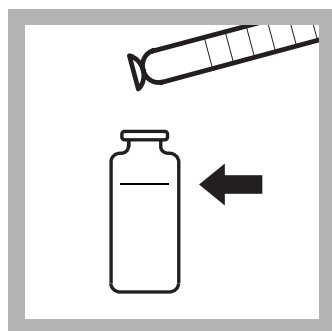

5. **Digested Sample:** Fill a square sample bottle to the 25-mL mark with diluted sample from step 3.



6. Add the contents of one Potassium Persulfate for Phosphonate Powder Pillow to the bottle containing 25 mL of sample.

Swirl to dissolve the powder.



7. Insert the ultraviolet (UV) lamp into the sample bottle.

CAUTION
Wear UV safety goggles while the lamp is on.

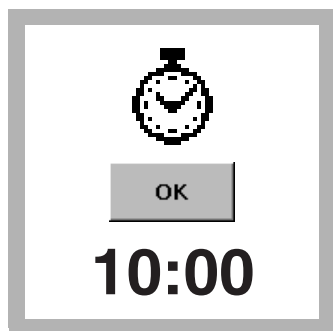

8. Turn on the UV lamp. Press **TIMER>OK**.

A ten-minute reaction period will begin.

Phosphonates are converted to orthophosphate in this step.



9. When the timer expires, turn off the UV lamp and remove it from the sample.

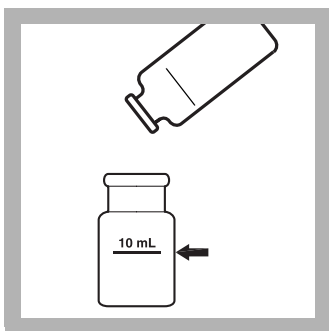

10. **Prepared Sample:** Fill a second square sample cell to the 10-mL mark with the digested sample.

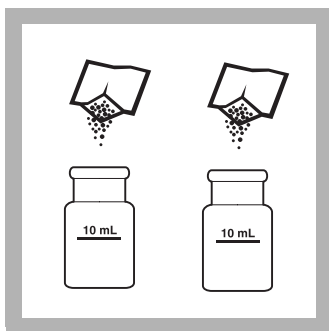

11. Add the contents of one PhosVer 3 Phosphate Reagent Powder Pillow to the blank and prepared sample. Immediately swirl vigorously 20–30 seconds to mix. Some powder may not dissolve.

A blue color will develop if phosphate is present. Both sample and blank cells may develop color. The increase in sample color is proportional to the phosphonate concentration.

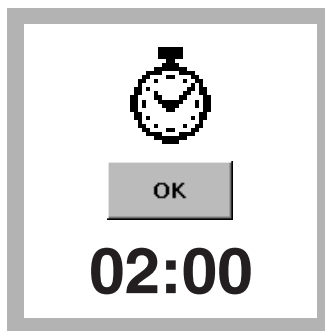

12. Press **TIMER>OK**.

A two-minute reaction period will begin.

If the sample is colder than 15 °C, allow four minutes for color development.



13. When the timer expires, insert the blank into the cell holder with the fill line facing right.

Complete steps 14–16 within three minutes after the timer expires.

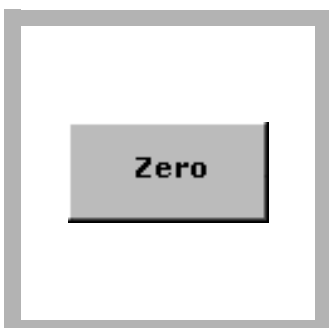

14. Press **ZERO**.
The display will show:
0.00 mg/L PO₄³⁻

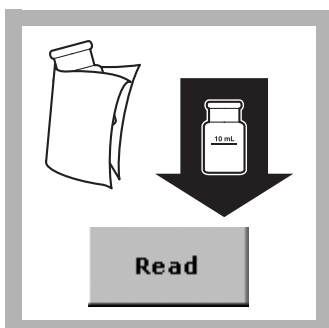

15. Wipe the prepared sample and insert it into the cell holder with the fill line facing right.

Press **READ**. Results are in mg/L PO₄³⁻.

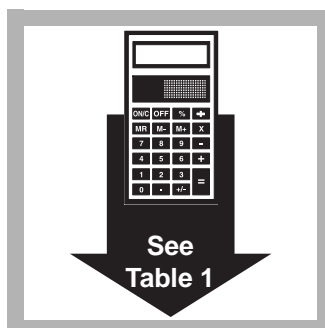

16. Multiply the value in step 15 by the appropriate multiplier in [Table 1 on page 4](#) to obtain the actual phosphonate concentration.

Table 1 Expected Ranges with Multipliers

Expected Range (mg/L phosphonate)	Sample Volume (mL)	Multiplier
0–2.5	50	0.1
0–5	25	0.2
0–12.5	10	0.5
0–25	5	1.0
0–125	1	5.0

To express results in terms of active phosphonate, multiply the final value in step 16 by the appropriate conversion factor in Table 2.

Table 2 Conversion Factors by Phosphonate Type

Phosphonate Type	Conversion Factor
PBTC	2.84
NTP	1.050
HEDPA	1.085
EDTMPA	1.148
HMDTMPA	1.295
DETPMPA	1.207
HPA	1.49

active phosphonate (mg/L) = phosphonate concentration from step 16 ↔ conversion factor

Interferences

Table 3 Interfering Substances and Levels

Interfering Substance	Interference Levels and Treatments
Aluminum	100 mg/L
Arsenate	Interferes at all levels
Benzotriazole	10 mg/L
Bicarbonate	1000 mg/L
Bromide	100 mg/L
Calcium	5000 mg/L
CDTA	100 mg/L
Chloride	5000 mg/L
Chromate	100 mg/L
Copper	100 mg/L
Cyanide	100 mg/L (Increase the UV digestion to 30 minutes.)
Diethanoldithiocarbamate	50 mg/L
EDTA	100 mg/L
Iron	200 mg/L
Nitrate	200 mg/L
NTA	250 mg/L
Orthophosphate	15 mg/L
Phosphites and organophosphorus compounds	Reacts quantitatively. Meta- and polyphosphates do not interfere.

Table 3 Interfering Substances and Levels (continued)

Interfering Substance	Interference Levels and Treatments
Silica	500 mg/L
Silicate	100 mg/L
Sulfate	2000 mg/L
Sulfide	Interferes at all levels
Sulfite	100 mg/L
Thiourea	10 mg/L
Highly buffered samples or extreme sample pH	May exceed the buffering capacity of the reagents and require sample pretreatment.

The interference levels will decrease as the sample size increases. For example, copper does not interfere at or below 100 mg/L for a 5.00 mL sample. If the sample volume is increased to 10 mL, copper will begin to interfere above 50 mg/L.

Sample Collection, Storage, and Preservation

Collect samples in acid-cleaned (1:1 HCl*) plastic or glass bottles that have been rinsed with distilled water. Do not use a commercial detergent. If prompt analysis is impossible, preserve the sample by adjusting to pH 2 or less with Sulfuric Acid* (about 2 mL per liter). Store at 4 °C (39 °F). Preserved samples may be stored up to 24 hours. Correct the test result for volume additions.

Accuracy Check

Ideally, a solution containing the phosphonate product being used should be prepared. This will check the UV conversion of phosphonate to orthophosphate. Alternatively, a phosphate standard can be used to check the accuracy of the colorimetric part of the method.

Standard Solution

A 1-mg/L Phosphate Standard Solution can be used to check accuracy. Use 10 mL of this standard in place of the prepared sample in step 10 on page 3. Use deionized water for the blank. A multiplier value from Table 1 on page 4 is not needed. The result should be 10.0 mg/L phosphate, due to a factor of 10 in calibration.

Summary of Method

This method is directly applicable to boiler and cooling tower samples. The procedure is based on a UV-catalyzed oxidation of phosphonate to orthophosphate. The orthophosphate reacts with the molybdate in the PhosVer 3 reagent to form a mixed phosphate/molybdate complex. This complex is reduced by the ascorbic acid in the PhosVer 3, yielding a blue color that is proportional to the phosphonate present in the original sample. Test results are measured at 880 nm.

* See [Optional Reagents and Apparatus on page 6](#).

Phosphonates (0.02 to 2.50 and 1.0 to 125.0 mg/L)

Consumables and Replacement Items

Required Reagents

Description	Quantity/Test	Unit	Cat. No.
Phosphonate Reagent Set for 10-mL sample (100 tests), includes:	—	—	24297-00
PhosVer® 3 Phosphate Reagent Powder Pillows, 10-mL	2	100/pkg	21060-69
Potassium Persulfate Powder Pillow for Phosphonate	1	100/pkg	20847-69
Water, deionized	varies	4 L	272-56

Required Apparatus

Description	Quantity/Test	Unit	Cat. No.
Bottle, square, with 25-mL mark	1	each	17042-00
Polypropylene Beaker, 50-mL, low form, with pour spout	1	each	1080-41
Cylinder, mixing, graduated, 50-mL	1	each	1896-41
Goggles, UV safety	1	each	21134-00
Pipet, serological, graduated, 10-mL	1	each	532-38
Safety Bulb	1	each	14651-00
Sample Cells, 1-inch square, 10 mL, matched pair	2	2/pkg	24954-02
UV Lamp with Power Supply, 115 VAC	1	each	20828-00
OR			
UV Lamp with Power Supply, 230 VAC	1	each	20828-02

Recommended Standards

Description	Unit	Cat. No.
Phosphate Standard Solution, 1-mg/L	500 mL	2569-49

Optional Reagents and Apparatus

Description	Cat. No.
Hydrochloric Acid Solution, 1:1, 500 mL	884-49
Sulfuric Acid, 500 mL	979-49



FOR TECHNICAL ASSISTANCE, PRICE INFORMATION AND ORDERING:
In the U.S.A. – Call toll-free 800-227-4224
Outside the U.S.A. – Contact the HACH office or distributor serving you.
On the Worldwide Web – www.hach.com; E-mail – techhelp@hach.com

HACH COMPANY
WORLD HEADQUARTERS
Telephone: (970) 669-3050
FAX: (970) 669-2932

Phosphorus, Acid Hydrolyzable Digestion

★ Method 8180

Acid Digestion Method¹

Scope and Application: For water, wastewater, and seawater; USEPA Accepted for wastewater analyses

¹ Adapted from *Standard Methods for the Examination of Water and Wastewater* 4500-P B & E



Test Preparation

Before starting the test:

Rinse all glassware with 1:1 hydrochloric acid. Rinse again with deionized water.

The results of the reactive phosphorus test after the digestion will include the orthophosphate and the acid-hydrolyzable (condensed) phosphate. The condensed phosphate concentration is determined by subtracting the result of an orthophosphate test from this result. Make sure that both results are in the same units, either mg/L PO_4^{3-} or mg/L P before subtracting. The result from this test is subtracted from the result of a total phosphorus test to determine organic phosphorus.

Collect the following items:

Quantity

Sodium Hydroxide Solution, 5.0 N	2 mL
Sulfuric Acid Solution, 5.25 N	2 mL
Water, deionized	varies
Cylinder, graduated, 25-mL	1
Flask, Erlenmeyer, 125-mL	1
Hot Plate	1

Note: Reorder information for consumables and replacement items is on page 4.

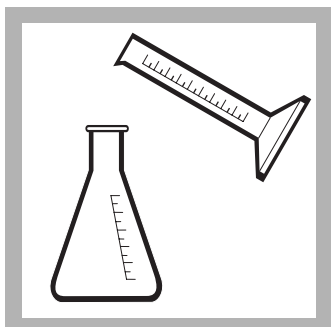

1. Use a graduated cylinder to measure 25 mL of sample. Pour the sample into a 125-mL Erlenmeyer flask.



2. Use a 1-mL calibrated dropper to add 2.0 mL of 5.25 N Sulfuric Acid Solution to the flask.

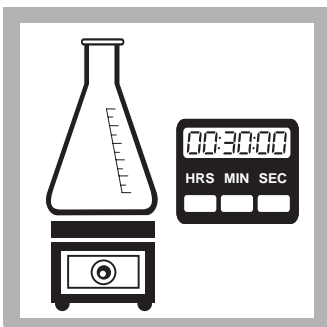

3. Place the flask on a hot plate. Boil gently for 30 minutes. Do not boil dry.

Concentrate the sample to less than 20 mL for best recovery. After concentration, maintain the volume near 20 mL by adding small amounts of deionized water. Do not exceed 20 mL.



4. Cool the sample to room temperature.

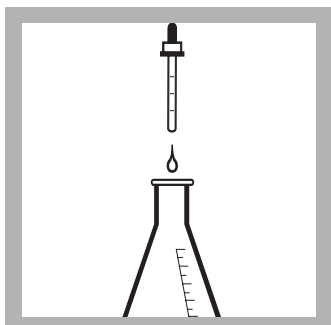

5. Use a 1-mL calibrated dropper to add 2.0 mL of 5.0 N Sodium Hydroxide Solution to the flask. Swirl to mix.

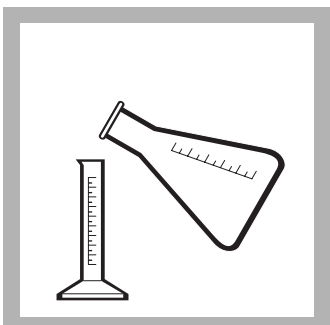

6. Pour the sample into a 25-mL graduated cylinder. Adjust the volume to 25 mL with deionized water rinsings from the flask.

480 P React. Mo.
482 P React. Mo. AV
485 P React. Amino
490 P React. PV
492 P React. PV AV
535 P React. PV TNT
540 P React. HR TNT

7. Proceed with a reactive phosphorus test of the expected acid hydrolyzable phosphorus concentration range.

Extend the color development time to 10 minutes for the PhosVer 3 method.

Interferences

Table 1 Interfering Substances and Levels

Interfering Substance	Interference Levels and Treatments
Alkaline or highly buffered samples	It may be necessary to add additional acid in step 2 to drop the pH of the solution below 1.
Turbidity	Use 50 mL of sample and double the reagent quantities. Use a portion of the reacted sample to zero the instrument in the reactive phosphorus procedure. This compensates for any color or turbidity destroyed by this procedure.

Sample Collection, Storage, and Preservation

Analyze the samples immediately for the most reliable results. If prompt analysis is not possible, samples may be preserved up to 28 days by adjusting the pH to 2 or less with Concentrated Sulfuric Acid* (about 2 mL per liter) and storing at 4 °C. Warm the sample to room temperature and neutralize with 5.0 N Sodium Hydroxide before analysis. Correct for volume additions.

Summary of Method

Phosphates present in condensed inorganic forms (meta-, pyro- or other polyphosphates) must be converted to reactive orthophosphate before analysis. Pretreatment of the sample with acid and heat hydrolyzes the condensed inorganic forms to orthophosphate.

This procedure must be followed by one of the reactive phosphorus (orthophosphate) analysis methods for determining the phosphorus content of the sample. If the ascorbic acid (PhosVer 3) method is used to measure the reactive phosphorus, this method is USEPA accepted for NPDES reporting.

* See [Optional Reagents on page 4](#).

Phosphorus, Acid Hydrolyzable Digestion

The following reagents and apparatus are required in addition to those required for the active phosphorus test.

Consumables and Replacement Items

Required Reagents

Description	Quantity/Test	Unit	Cat. No.
Sodium Hydroxide Solution, 5.0 N	2 mL	100 mL MDB	2450-32
Sulfuric Acid Solution, 5.25 N	2 mL	100 mL MDB	2449-32
Water, deionized	varies	4 L	272-56

Required Apparatus

Description	Quantity/Test	Unit	Cat. No.
Cylinder, graduated, 25-mL	1	each	508-40
Flask, Erlenmeyer, 125-mL	1	each	505-43
Hot Plate, 4 inch diameter, 120 VAC	1	each	12067-01
Hot Plate, 4 inch diameter, 240 VAC	1	each	12067-02

Required Apparatus (Field Applications)

Description	Unit	Cat. No.
Heatab Cookit, with 1 box heatabs	each	2206-00
Heatab Replacements	21/pkg	2207-00

Optional Reagents

Description	Cat. No.
Sodium, Hydroxide, 5.0 N, 1000 mL	2450-53
Sulfuric Acid, concentrated, 500 mL	979-49



FOR TECHNICAL ASSISTANCE, PRICE INFORMATION AND ORDERING:
In the U.S.A. – Call toll-free 800-227-4224
Outside the U.S.A. – Contact the HACH office or distributor serving you.
On the Worldwide Web – www.hach.com; E-mail – techhelp@hach.com

HACH COMPANY
WORLD HEADQUARTERS
Telephone: (970) 669-3050
FAX: (970) 669-2932

Phosphorus, Acid Hydrolyzable

Method 8180

PhosVer™ 3 with Acid Hydrolysis Method

Test 'N Tube™ Vials

(0.06 to 3.50 mg/L PO₄³⁻)

Scope and Application: For water, wastewater, and seawater



Test Preparation

Before starting the test:

Important Note: Install the light shield in Cell Compartment #2 before performing this test.

For more accurate results, determine a reagent blank value for each new lot of reagent. Follow the procedure using deionized water in place of the sample. Subtract the reagent blank value from the final results or perform a reagent blank adjust.

Clean glassware with 1:1 Hydrochloric Acid Standard Solution. Rinse with deionized water. Do not use detergents that contain phosphate to clean glassware.

Final samples will contain molybdenum. In addition, final samples will have a pH less than 2 and are considered corrosive (D002) by the Federal RCRA. Refer to the current MSDS for safe handling and disposal instructions.

Collect the following items:

Quantity

Total and Acid Hydrolyzable Phosphorus Reagent Set	1
Deionized water	varies
DRB200 Reactor	1
Funnel, micro	1
Light Shield	1
Pipet, TenSette®, 1 to 10 mL, plus tips	
Test Tube Rack	1

Note: Reorder information for consumables and replacement items is on page 6.

Test 'N Tube

Method 8180

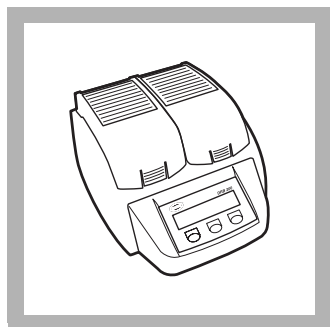

1. Turn on the DRB200 Reactor. Preheat to 150 °C.

See the DRB200 User Manual for selecting pre-programmed temperature applications.

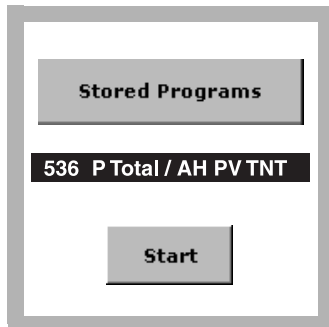

2. Select the test.
Install the Light Shield in Cell Compartment #2.

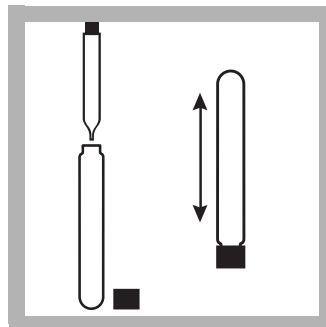

3. Use a TenSette Pipet to add 5 mL of sample to a Total and Acid Hydrolyzable Test Vial. Cap and mix.

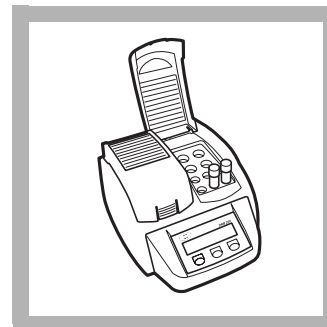

4. Insert the vial into the preheated DRB200 reactor. Close the protective cover.



5. Press **TIMER>OK**.
A 30-minute heating period will begin.

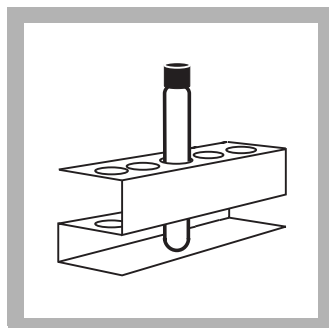

6. After the timer expires, carefully remove the vial from the reactor. Insert it in a test tube rack and cool to room temperature.

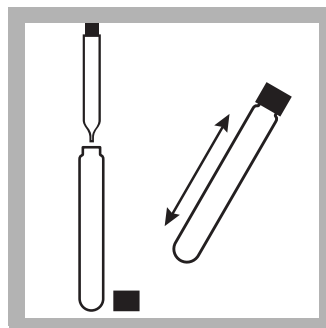

7. Using a TenSette Pipet, add 2 mL of 1.00 N sodium hydroxide to the vial. Cap tightly and shake to mix.

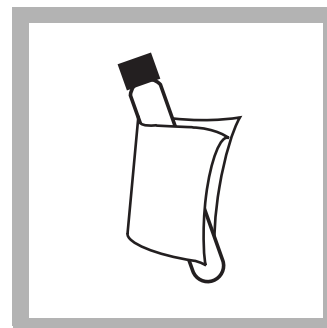

8. Clean the outside of the vial with a towel to remove fingerprints or other marks.



9. Insert the sample vial into the 16-mm round cell holder.

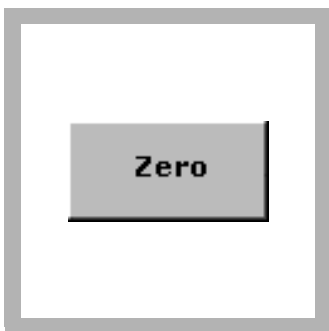

10. Press **ZERO**.
The display will show:
0.00 mg/L PO₄³⁻

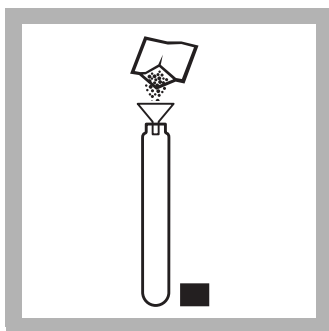

11. Using a funnel, add the contents of one PhosVer 3 Powder Pillow to the vial.

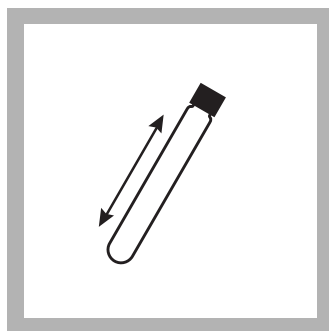

12. Immediately cap tightly and shake to mix for 10–15 seconds. The powder will not completely dissolve.

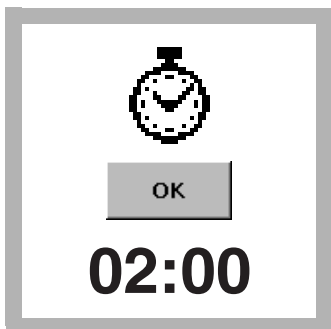

13. Press **TIMER>OK**.
A two-minute reaction period will begin.
Read results within two to eight minutes after adding the PhosVer 3 reagent.



14. Clean the outside of the vial with a towel to remove fingerprints or other marks.



15. Wipe the prepared sample and insert it into the 16-mm round cell holder.

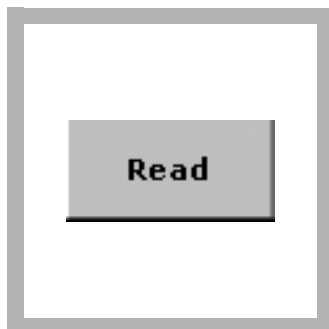

16. Press **READ**.
Results are in mg/L PO₄³⁻.

Interferences

Table 1 Interfering Substances and Levels

Interfering Substance	Interference Levels and Treatments
Aluminum	Greater than 200 mg/L
Arsenate	All levels
Chromium	Greater than 100 mg/L
Copper	Greater than 10 mg/L
Iron	Greater than 100 mg/L
Nickel	Greater than 300 mg/L
Silica	Greater than 50 mg/L
Silicate	Greater than 10 mg/L
Sulfide	Greater than 9 mg/L. Remove sulfide interference as follows: <ol style="list-style-type: none"> 1. Measure 25 mL of sample into a 50-mL beaker. 2. Swirling constantly, add Bromine Water drop-wise until a permanent yellow color appears. 3. Swirling constantly, add Phenol Solution drop-wise just until the yellow color disappears. Proceed with step 1.
Turbidity	Large amounts may cause inconsistent results in the test because the acid present in the powder pillows may dissolve some of the suspended particles and because of variable desorption of orthophosphate from the particles.
Zinc	Greater than 80 mg/L
Highly buffered samples or extreme sample pH	May exceed the buffering capacity of the reagents and require sample pretreatment.

Sample Collection, Storage, and Preservation

Collect samples in plastic or glass bottles that have been acid washed with 1:1 Hydrochloric Acid Solution and rinsed with deionized water. Do not use commercial detergents containing phosphate for cleaning glassware used in this test.

Analyze samples immediately for best results. If prompt analysis is not possible, preserve samples by filtering immediately and storing the sample at 4 °C (39 °F) for up to 48 hours.

Accuracy Check

Standard Additions Method (Sample Spike)

1. After reading test results, leave the sample cell (unspiked sample) in the instrument. Verify the chemical form.
2. Press **OPTIONS>MORE**. Press **STANDARD ADDITIONS**. A summary of the standard additions procedure will appear.
3. Press **OK** to accept the default values for standard concentration, sample volume, and spike volumes. Press **EDIT** to change these values. After values are accepted, the unspiked sample reading will appear in the top row. See the user manual for more information.
4. Snap the neck off a Phosphate 2-mL Ampule Standard, 50-mg/L as PO₄³⁻.

5. Prepare three sample spikes. Fill three Mixing Cylinders with 25 mL of sample. Use the TenSette® Pipet to add 0.1 mL, 0.2 mL, and 0.3 mL of standard, respectively, to each sample and mix thoroughly.
6. Analyze each sample spike as described in the procedure above, starting with the 0.1 mL sample spike. Accept each standard additions reading by pressing **READ**. Each addition should reflect approximately 100% recovery.
7. After completing the sequence, press **GRAPH** to view the best-fit line through the standard additions data points, accounting for matrix interferences. Press **IDEAL LINE** and press **OK** to view the relationship between the sample spikes and the "Ideal Line" of 100% recovery.

Standard Solution Method

1. Use a 3.0-mg/L Phosphate Standard Solution in place of the sample. Perform the procedure as described.
2. To adjust the calibration curve using the reading obtained with the standard solution, press **OPTIONS>MORE** on the current program menu. Press **STANDARD ADJUST**.
3. Press **ON**. Press **ADJUST** to accept the displayed concentration (the value depends on the selected chemical form). If an alternate concentration is used, press the number in the box to enter the actual concentration, then press **OK**. Press **ADJUST**.

Summary of Method

Phosphates present in condensed inorganic forms (meta-, pyro-, or other polyphosphates) must be converted to reactive orthophosphate before analysis. Pretreating the sample with acid and heat hydrolyzes the condensed inorganic forms to orthophosphate.

Orthophosphate reacts with molybdate in an acid medium to produce a mixed phosphate/molybdate complex. Ascorbic acid then reduces the complex, giving an intense molybdenum blue color. Test results are measured at 880 nm.

Consumables and Replacement Items

Required Reagents

Description	Quantity/Test	Unit	Cat. No.
Total and Acid Hydrolyzable Phosphorus Reagent Set, includes:		50 tests	27427-45
PhosVer 3 Phosphate Reagent Powder Pillows	1 pillow	50/pkg	21060-46
Potassium Persulfate Powder Pillows	1	50/pkg	20847-66
Sodium Hydroxide, 1.54 N	varies	100 mL	27430-42
Sodium Hydroxide Standard Solution, 1.00 N	2 mL	100 mL	1045-42
Total and Acid Hydrolyzable Test Vials ¹	1 vial	50/pkg	—
Water, deionized	varies	100 mL	272-42

¹ Not sold separately.

Required Apparatus

Description	Quantity/Test	Unit	Cat. No.
DRB200 Reactor, 110 V, 15 x 16 mm	1	each	LTV082.53.40001
DRB200 Reactor, 220 V, 15 x 16 mm	1	each	LTV082.52.40001
Funnel, micro	1	each	25843-35
Light Shield	1	each	LZV646
Pipet, volumetric, Class A, 2.00-mL	1	each	14515-36
Pipet, volumetric, Class A, 5.00-mL	1	each	14515-37
Pipet Filler, safety bulb	1	each	14651-00
Pipet, TenSette®, 1 to 10 mL	1	each	19700-10
Pipet Tips for TenSette Pipet 19700-10	1	250/pkg	21997-25
Test Tube Rack	1-3	each	18641-00

Recommended Standards

Description	Unit	Cat. No.
Drinking Water Standard, Mixed Parameter, Inorganic for F ⁻ , NO ₃ , PO ₄ , SO ₄	500 mL	28330-49
Phosphate Standard Solution, 10-mL Voluette® Ampule, 50-mg/L as PO ₄ ³⁻	16/pkg	171-10
Phosphate Standard Solution, 1-mg/L as PO ₄ ³⁻	500 mL	2569-49
Phosphate Standard Solution, 3 mg/L as PO ₄ ³⁻	946 mL	20597-16
Wastewater Standard, Effluent Inorganics, for NH ₃ -N, NO ₃ -N, PO ₄ , COD, SO ₄ , TOC	500 mL	28332-49

Optional Reagents

Description	Cat. No.
Bromine Water, 29 mL	2211-20
Cylinder, mixing, 25 mL	1896-40
Hydrochloric Acid Solution, 1:1, 500 mL	884-49
Phenol Solution, 29 mL	2112-20



FOR TECHNICAL ASSISTANCE, PRICE INFORMATION AND ORDERING:
 In the U.S.A. – Call toll-free 800-227-4224
 Outside the U.S.A. – Contact the HACH office or distributor serving you.
 On the Worldwide Web – www.hach.com; E-mail – techhelp@hach.com

HACH COMPANY
 WORLD HEADQUARTERS
 Telephone: (970) 669-3050
 FAX: (970) 669-2932

Phosphorus, Total, Digestion

★ Method 8190

Acid Persulfate Digestion Method¹

Scope and Application: For water, wastewater, and seawater; USEPA Accepted for wastewater analyses when used with the ascorbic acid (PhosVer 3) method.

¹ Adapted from *Standard Methods for the Examination of Water and Wastewater* 4500-P B & E



Test Preparation

Before starting the test:

Rinse all glassware with 1:1 hydrochloric acid. Rinse again with deionized water.

The results of the reactive phosphorus test after the digestion will include the orthophosphate and the acid-hydrolyzable (condensed) phosphate. The condensed phosphate concentration is determined by subtracting the result of an orthophosphate test from this result. Make sure that both results are in the same units, either mg/L PO₄³⁻ or mg/L P before subtracting.

Collect the following items:

Quantity

Potassium Persulfate Powder Pillows	1
Sodium Hydroxide Solution, 5.0 N	2 mL
Sulfuric Acid Solution, 5.25 N	2 mL
Water, deionized	varies
Cylinder, graduated, 25-mL	1
Flask, Erlenmeyer, 125-mL	1
Hot Plate	1

Note: Reorder information for consumables and replacement items is on page 4.

Acid Digestion

Method 8190

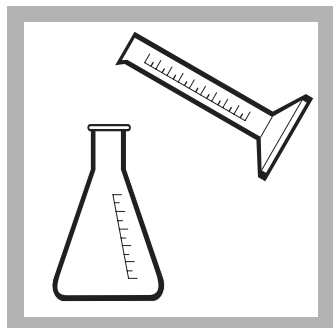

1. Use a graduated cylinder to measure 25 mL of sample. Pour the sample into a 125-mL Erlenmeyer flask.

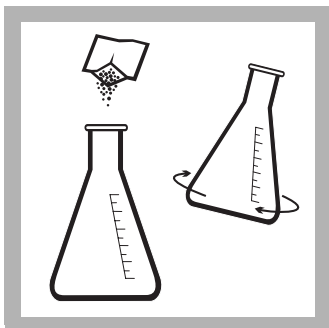

2. Add the contents of one Potassium Persulfate Powder Pillow. Swirl to mix.



3. Use a 1-mL calibrated dropper to add 2.0 mL of 5.25 N Sulfuric Acid Solution to the flask.

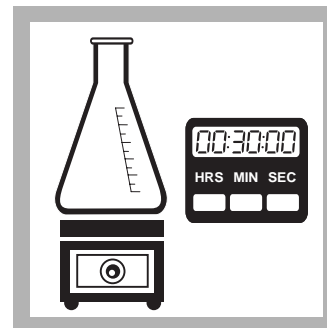

4. Place the flask on a hot plate. Boil gently for 30 minutes. Do not boil dry.

Concentrate the sample to less than 20 mL for best recovery. After concentration, maintain the volume near 20 mL by adding small amounts of deionized water. Do not exceed 20 mL.



5. Cool the sample to room temperature.



6. Use a 1-mL calibrated dropper to add 2.0 mL of 5.0 N Sodium Hydroxide Solution to the flask. Swirl to mix.

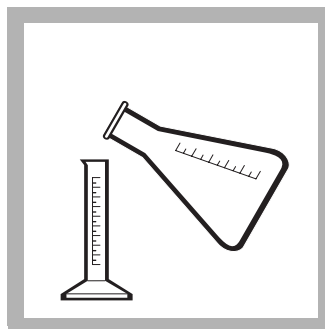

7. Pour the sample into a 25-mL graduated cylinder. Adjust the volume to 25 mL with deionized water rinsings from the flask.

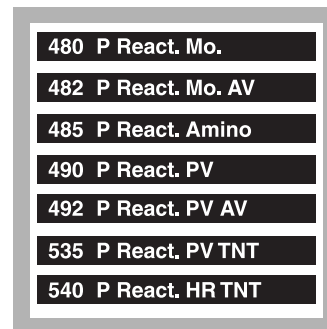

8. Proceed with a reactive phosphorus test of the expected total phosphorus concentration range.

Extend the color development time to 10 minutes for the PhosVer 3 (ascorbic acid) method.

Interferences

Table 1 Interfering Substances and Levels

Interfering Substance	Interference Levels and Treatments
Alkaline or highly buffered samples	It may be necessary to add additional acid in step 3 to drop the pH of the solution below 1.
Turbidity	Use 50 mL of sample and double the reagent quantities. Use a portion of the reacted sample to zero the instrument in the reactive phosphorus procedure. This compensates for any color or turbidity destroyed by this procedure.

Sample Collection, Storage, and Preservation

Analyze the samples immediately for the most reliable results. If prompt analysis is not possible, samples may be preserved up to 28 days by adjusting the pH to 2 or less with Concentrated Sulfuric Acid* (about 2 mL per liter) and storing at 4 °C. Warm the sample to room temperature and neutralize with 5.0 N Sodium Hydroxide before analysis. Correct for volume additions.

Summary of Method

Phosphates present in organic and condensed inorganic forms (meta-, pyro-, or other polyphosphates) must be converted to reactive orthophosphate before analysis. Pretreatment of the sample with acid and heat provides the conditions for hydrolysis of the condensed inorganic forms. Organic phosphates are converted to orthophosphate by heating with acid and persulfate. Organically bound phosphates are thus determined indirectly by subtracting the result of an acid hydrolyzable phosphorus test from the total phosphorus result.

This procedure must be followed by one of the reactive phosphorus (orthophosphate) analysis methods for determining the phosphorus content of the sample. If the ascorbic acid (PhosVer 3) method is used to measure the reactive phosphorus, this method is USEPA accepted for NPDES reporting.

The following reagents and apparatus are required in addition to those required for the active phosphorus test.

* See [Optional Reagents on page 4](#).

Consumables and Replacement Items

Required Reagents

Description	Quantity/Test	Unit	Cat. No.
Potassium Persulfate Powder Pillows	1	100/pkg	2451-99
Sodium Hydroxide Solution, 5.0 N	2 mL	100 mL MDB	2450-32
Sulfuric Acid Solution, 5.25 N	2 mL	100 mL MDB	2449-32
Water, deionized	varies	4 L	272-56

Required Apparatus

Description	Quantity/Test	Unit	Cat. No.
Cylinder, graduated, 25-mL	1	each	508-40
Flask, Erlenmeyer, 125-mL	1	each	505-43
Hot Plate, 4 inch diameter, 120 VAC	1	each	12067-01
Hot Plate, 4 inch diameter, 240 VAC	1	each	12067-02

Optional Reagents

Description	Unit	Cat. No.
Sodium, Hydroxide, 5.0 N	1000 mL	2450-53
Sulfuric Acid, concentrated	500 mL	979-49



FOR TECHNICAL ASSISTANCE, PRICE INFORMATION AND ORDERING:
In the U.S.A. – Call toll-free 800-227-4224
Outside the U.S.A. – Contact the HACH office or distributor serving you.
On the Worldwide Web – www.hach.com; E-mail – techhelp@hach.com

HACH COMPANY
WORLD HEADQUARTERS
Telephone: (970) 669-3050
FAX: (970) 669-2932

Phosphorus, Reactive (Orthophosphate)

Method 8178

Amino Acid Method¹
(0.23 to 30.00 mg/L PO₄³⁻)

Scope and Application: For water, wastewater, and seawater

¹ Adapted from *Standard Methods for the Examination of Water and Wastewater*



Test Preparation

Before starting the test:

For more accurate results, determine a reagent blank value for each new lot of reagent. Follow the procedure using deionized water in place of the sample. Subtract the reagent blank value from the final results or perform a reagent blank adjust

The contents of one Amino Acid Reagent Powder Pillow may be substituted for 1 mL of amino acid reagent solution in step 5.

Collect the following items:

Quantity

Amino Acid Reagent	1 mL
Cylinder, 25-mL, graduated, mixing	1
Molybdate Reagent	1 mL
Sample Cells, 1-inch square, 10 mL, matched pair	2

Note: Reorder information for consumables and replacement items is on page 4.

Amino Acid Method

Method 8178



1. Press **STORED PROGRAMS**.

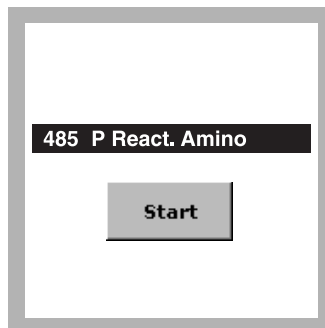

2. Select the test.

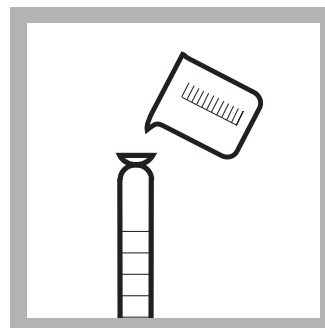

3. Fill a 25-mL mixing cylinder with 25 mL of sample.

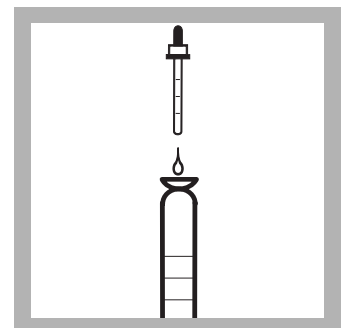

4. Add 1 mL of Molybdate Reagent using a 1-mL calibrated dropper.

Phosphorus, Reactive (Orthophosphate) (0.23 to 30.00 mg/L PO₄³⁻)

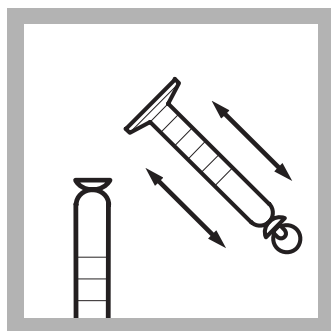

5. Prepared Sample: Add 1 mL of Amino Acid Reagent Solution. Stopper and invert several times to mix.

A blue color will form if phosphate is present.



6. Press TIMER>OK.
A 10-minute reaction period will begin. Continue with step 7 while the timer is running.

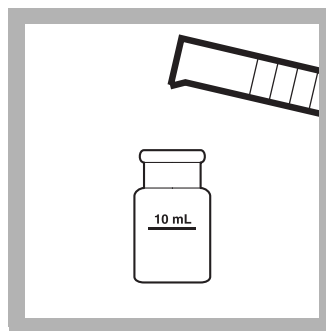

7. Blank Preparation: Fill a square sample cell with untreated sample.



8. When the timer expires, wipe the blank and insert it into the cell holder with the fill line facing right.

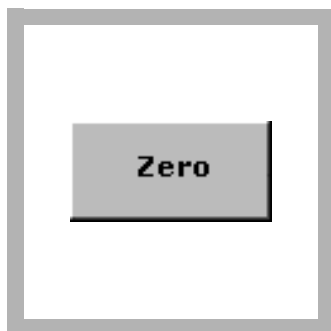

9. Press ZERO.
The display will show:
0.00 mg/L PO₄³⁻

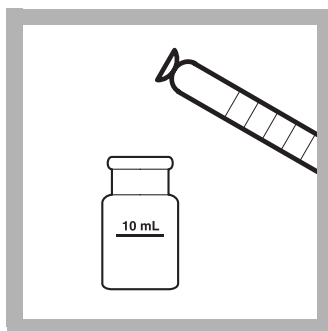

10. Fill a second square cell with prepared sample.



11. Wipe the prepared sample and insert it into the cell holder with the fill line facing right.

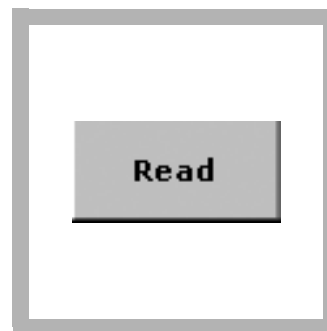

12. Press READ.
Results are in mg/L PO₄³⁻.

Interferences

Table 1 Interfering Substances and Levels

Interfering Substance	Interference Levels and Treatments
Calcium (Ca ²⁺)	Greater than 10,000 mg/L as CaCO ₃
Chloride	Greater than 150,000 mg/L Cl ⁻
Colored samples	Add 1 mL of 10 N Sulfuric Acid Standard Solution ¹ to another 25-mL sample. Use this instead of untreated sample as the blank to zero the instrument. Use a pipet and pipet filler to measure the sulfuric acid standard.
High salt levels (Na ⁺)	May cause low results. To eliminate this interference, dilute the sample until two successive dilutions yield about the same result.
Magnesium	Greater than 40,000 mg/L as CaCO ₃
Nitrites (NO ₂ ⁻)	Bleach the blue color. Remove nitrite interference by adding 0.05 g of sulfamic acid ¹ to the sample. Swirl to mix. Continue with step 5.
Phosphates, high levels (PO ₄ ³⁻)	As the concentration of phosphate increases, the color changes from blue to green, then to yellow and finally to brown. The brown color may suggest a concentration as high as 100,000 mg/L PO ₄ ³⁻ . If a color other than blue is formed, dilute the sample and retest.

Table 1 Interfering Substances and Levels (continued)

Interfering Substance	Interference Levels and Treatments
Sulfide (S ²⁻)	Sulfide interferes. For samples with sulfide concentration less than 5 mg/L sulfide interference may be removed by oxidation with Bromine Water as follows: <ol style="list-style-type: none"> 1. Measure 50 mL of sample into an Erlenmeyer flask. 2. Add Bromine Water¹ drop-wise with constant swirling until permanent yellow color develops. 3. Add Phenol Solution¹ drop-wise until the yellow color just disappears. Use this solution in steps 3 and 7.
Temperature	For best results, sample temperature should be 21 ±3 °C (70 ±5 °F).
Turbidity	May give inconsistent results for two reasons. Some suspended particles may dissolve because of the acid used in the test. Also, desorption of orthophosphate from particles may occur. For highly turbid samples, add 1 mL of 10 N Sulfuric Acid Standard Solution ¹ to another 25-mL sample. Use this instead of untreated sample as the blank to zero the instrument. Use a pipet and pipet filler to measure the sulfuric acid standard.
Highly buffered samples or extreme sample pH	May exceed the buffering capacity of the reagents and require sample pretreatment.

¹ See [Optional Reagents and Apparatus on page 4](#).

Sample Collection, Storage, and Preservation

Collect samples in clean plastic or glass bottles that have been cleaned with 1:1 Hydrochloric Acid Solution* and rinsed with deionized water. Do not use a commercial phosphate-based detergent for cleaning glassware because the phosphate content will contaminate the sample.

Analyze samples immediately for best results. If prompt analysis is not possible, preserve samples by filtering immediately and store at 4 °C (39 °F) for up to 48 hours. The sample should have a neutral pH (6–8) and be at room temperature before analysis.

Accuracy Check

Standard Additions Method (Sample Spike)

1. After reading test results, leave the sample cell (unspiked sample) in the instrument. Verify the chemical form.
2. Press **OPTIONS**. Press **STANDARD ADDITIONS**. A summary of the standard additions procedure will appear.
3. Press **OK** to accept the default values for standard concentration, sample volume, and spike volumes. Press **EDIT** to change these values. After values are accepted, the unspiked sample reading will appear in the top row.
4. Snap the neck off a Phosphate 2-mL Ampule Standard, 500-mg/L PO₄³⁻.
5. Prepare three sample spikes. Fill three mixing cylinders* with 25 mL of sample. Use the TenSette® Pipet to add 0.1 mL, 0.2 mL, and 0.3 mL of standard, respectively, to each sample and mix thoroughly.
6. Analyze each sample spike as described in the procedure above, starting with the 0.1 mL sample spike. Accept each standard additions reading by pressing **READ**. Each addition should reflect approximately 100% recovery.
7. After completing the sequence, press **GRAPH** to view the best-fit line through the standard additions data points, accounting for matrix interferences. Press **IDEAL LINE** to view the relationship between the sample spikes and the "Ideal Line" of 100% recovery.

* See [Optional Reagents and Apparatus on page 4](#).

Phosphorus, Reactive (Orthophosphate) (0.23 to 30.00 mg/L PO₄³⁻)

Standard Solution Method

1. Use a 10-mg/L Phosphate Standard Solution. Perform the amino acid procedure as described above.
2. To adjust the calibration curve using the reading obtained with the 10-mg/L PO₄³⁻ Phosphate Standard Solution, press **OPTIONS** on the current program menu. Press **STANDARD ADJUST**.
3. Press **ON**. Press **ADJUST** to accept the displayed concentration (the value depends on the selected chemical form). If an alternate concentration is used, press the number in the box to enter the actual concentration, then press **OK**. Press **ADJUST**.

Summary of Method

In a highly acidic solution, ammonium molybdate reacts with orthophosphate to form molybdophosphoric acid. This complex is then reduced by the amino acid reagent to yield an intensely colored molybdenum blue compound. Test results are measured at 530 nm.

Consumables and Replacement Items

Required Reagents

Description	Quantity/Test	Unit	Cat. No.
High Range Reactive Phosphorus Reagent Set, includes:	—	100 tests	22441-00
Amino Acid Reagent	1 mL	100 mL MDB	1934-32
Molybdate Reagent	1 mL	100 mL MDB	2236-32

Required Apparatus

Description	Quantity/Test	Unit	Cat. No.
Cylinder, 25-mL, graduated, mixing	1	each	1896-40
Sample Cells, 1-inch square, 10 mL, matched pair	2	2/pkg	24954-02

Recommended Standards

Description	Unit	Cat. No.
Phosphate Standard Solution, 10-mg/L	946 mL	14204-16
Phosphate Standard Solution, 2-mL Voluette® Ampule, 500-mg/L PO ₄ ³⁻	16/pkg	14242-20
Wastewater Effluent Standard, for mixed parameters NH ₃ -N, NO ₃ -N, PO ₄ , COD, SO ₄ , TOC	500 mL	28332-49
Wastewater Influent Standard for mixed parameters NH ₃ -N, NO ₃ -N, PO ₄ , COD, SO ₄ , TOC	500 mL	28331-49
Water, deionized	4 liters	272-56

Optional Reagents and Apparatus

Description	Unit	Cat. No.
Amino Acid Reagent Powder Pillow	100/pkg	804-99
Bromine Water	29 mL	2211-20
Flask, Erlenmeyer	each	505-43
Hydrochloric Acid Solution, 1:1	500 mL	884-49
Phenol Solution	29 mL	2112-20
Sulfamic Acid	113 g	2344-14
Sulfuric Acid Standard Solution, 10 N	1000 mL	931-53



FOR TECHNICAL ASSISTANCE, PRICE INFORMATION AND ORDERING:
In the U.S.A. – Call toll-free 800-227-4224
Outside the U.S.A. – Contact the HACH office or distributor serving you.
On the Worldwide Web – www.hach.com; E-mail – techhelp@hach.com

HACH COMPANY
WORLD HEADQUARTERS
Telephone: (970) 669-3050
FAX: (970) 669-2932

Phosphorus, Reactive

Method 8114

Molybdovanadate Rapid Liquid Method¹

Pour-Thru Cell

HR (0.3 to 45.0 mg/L PO₄³⁻)

Scope and Application: For treated and natural waters

¹ Adapted from Standard Methods for the Examination of Water and Wastewater.



Test Preparation

Before starting the test:

See the User Manual for Pour-Thru Module installation instructions.

Clean the Pour-Thru cell and all labware as specified in [Treating Analysis Labware on page 4](#).

Protect the Pour-Thru Cell from contamination when not in use by inverting a small beaker over the top of the glass funnel.

Final samples will contain molybdenum. In addition, final samples will have a pH less than 2 and are considered corrosive (D002) by the Federal RCRA. Refer to the current MSDS for safe handling and disposal information.

Collect the following items:

Quantity

Molybdovanadate Reagent	2
Water, deionized	25
Cylinder, graduated, 25-mL, poly	1
Dispenser, fixed volume, 1.0-mL, w/bottle	1
Flask, Erlenmeyer, 125-mL, PMP w/cap	2
Pour-Thru Cell Assembly Kit	1

Note: Reorder information for consumables and replacement items is on page 5.

Pour-Thru Cell

Method 8114

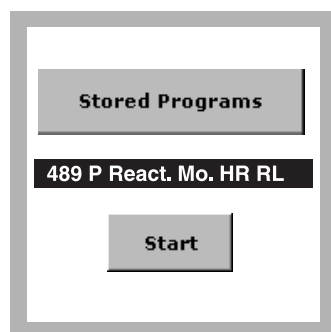

1. Select the test.

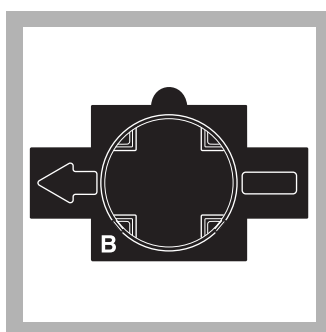

2. Insert Adapter B. Install the Pour-Thru Cell with the 1-inch (round) path in line with the adapter arrow. Flush the Pour-Thru cell with 50 mL of deionized water.

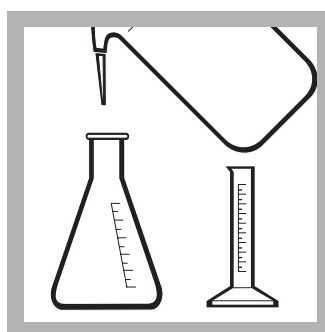

3. Rinse a clean plastic 125-mL Erlenmeyer flask and a 25-mL graduated cylinder with deionized water.

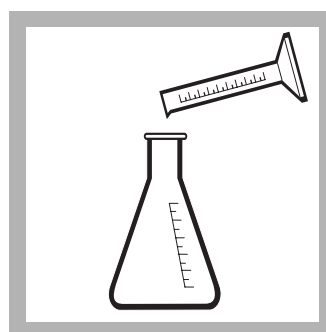

4. **Blank Preparation:** Measure 25 mL of deionized water in the graduated cylinder. Pour the water into the flask.

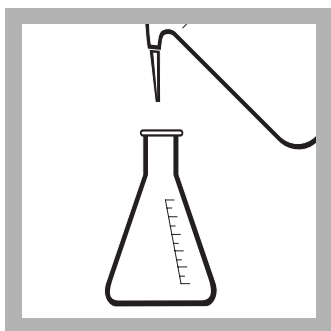

5. Rinse another clean plastic 125-mL Erlenmeyer flask with deionized water.

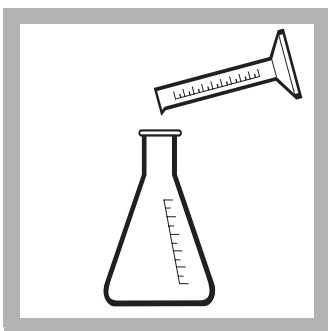

6. **Prepared Sample:** Measure 25 mL of sample in the graduated cylinder. Pour the water into the flask.

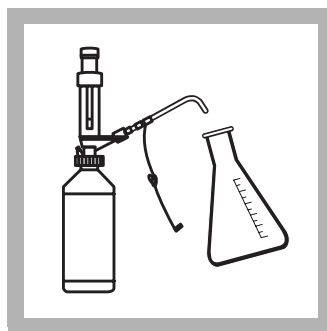

7. Add 1.0 mL of Molybdovanadate Reagent to each flask using a Repipet Jr. Dispenser. Swirl to mix.

A yellow color will develop in the sample if phosphate is present. A small amount of yellow may be present in the blank due to the reagent.

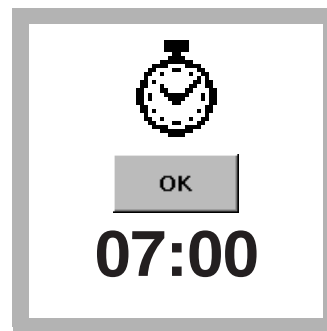

8. Press **TIMER>OK**.

A 7-minute reaction period will begin.

If the sample concentration is greater than 230 mg/L PO₄³⁻, read at exactly seven minutes or make a 1:1 dilution of the sample and begin the test again.

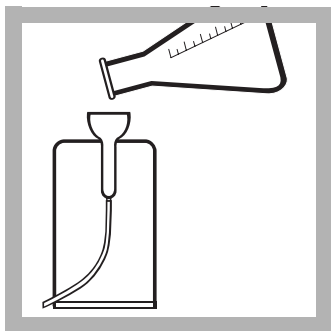

9. When the timer expires, pour the blank from the flask into the Pour-Thru Cell.

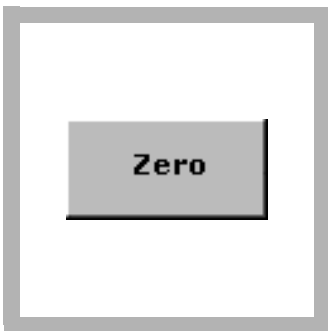

10. After the flow stops, press **ZERO**.

The display will show:

0.0 mg/L PO₄³⁻

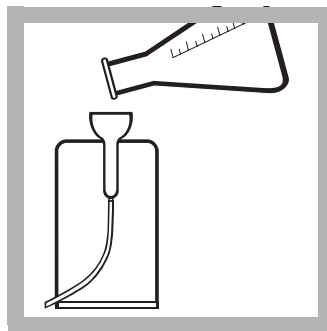

11. Pour the prepared sample from the flask into the Pour-Thru Cell.

Press **READ**. Results are in mg/L PO₄³⁻.

Flush the Pour-Thru Cell with 50 mL of deionized water.

Interferences

Table 1 Interfering Substances and Levels

Interfering Substance	Interference Levels and Treatments
Arsenate	Negative interference. Positive interference if sample is heated.
Bismuth	Negative interference.
Fluoride	Negative interference.
Iron, Ferrous	Blue color is caused by ferrous iron but this does not affect results if the ferrous iron concentration is less than 100 mg/L.
Molybdate	Negative interference.
Silica	Positive interference if sample is heated.
Sulfide	Negative interference. Sulfide interference may be removed by oxidation with Bromine Water as follows: <ol style="list-style-type: none"> 1. Measure 25 mL of sample into a flask. 2. Add Bromine Water¹ drop-wise with constant swirling until permanent yellow color develops. 3. Add Phenol Solution¹ drop-wise until the yellow color just disappears. Proceed with step 7.
Thiocyanate	Negative interference.
Thiosulfate	Negative interference.
Thorium	Negative interference.
Highly buffered samples or extreme sample pH	May exceed the buffering capacity of the reagents and require sample pretreatment.

¹ See [Optional Reagents and Apparatus](#) on page 5.

[Table 2](#) shows substances that do not interfere in concentrations less than 1000 mg/L.

Table 2 Noninterfering at Low Concentrations

Pyrophosphate	Tetraborate	Benzoate
Citrate	Lactate	Formate
Oxalate	Tartrate	Salicylate
Al ³⁺	Selenate	Mg ²⁺
Ca ²⁺	Ba ²⁺	Sr ²⁺
Li ⁺	Na ⁺	K ⁺
NH ₄ ⁺	Cd ²⁺	Mn ²⁺
NO ₃ ⁻	NO ₂ ⁻	SO ₄ ²⁻
SO ₃ ²⁻	Pb ²⁺	Hg ⁺
Hg ²⁺	Sn ²⁺	Cu ²⁺
Ni ²⁺	Ag ⁺	U
Zr ⁴⁺	AsO ₃ ⁻	Br ⁻
CO ₃ ²⁻	ClO ₄ ⁻	CN ⁻
IO ₃ ⁻	Fe ³⁺	SiO ₄ ⁴⁻

Sampling and Storage

Collect samples in clean plastic or glass bottles that have been cleaned with 1:1 Hydrochloric Acid Solution* and rinsed with deionized water. Do not use detergents that contain phosphate for cleaning labware.

Analyze samples immediately for best results. If prompt analysis is not possible, preserve samples by filtering immediately and storing the sample at 4 °C (39 °F) or below for up to 48 hours. Warm to room temperature before analyzing.

Treating Analysis Labware

Clean containers by normal means (do not use detergents containing phosphorus), then rinse with deionized water. Soak for several minutes in a 1:25 dilution of Molybdovanadate Reagent in deionized water. Rinse well with deionized water. Dedicate these containers for HR PO₄³⁻ analysis. Fill the Pour-Thru Cell with this same mixture of Molybdovanadate reagent and deionized water, and let stand for several minutes. Rinse with 50 mL of deionized water.

Cleaning the Pour-Thru Cell

The Pour-Thru Cell may accumulate a buildup of colored products, especially if the reacted solutions are allowed to stand in the cell for long periods after measurement. Remove the color by rinsing with a 1:5 dilution of ammonium hydroxide†, followed by several deionized water rinses. Invert a beaker over the glass funnel of the Pour-Thru Cell when not in use.

Accuracy Check

Standard Additions Method (Sample Spike)

1. After reading test results, leave the sample cell (unspiked sample) in the instrument. Verify the chemical form.
2. Press **OPTIONS>MORE**. Press **STANDARD ADDITIONS**. A summary of the standard additions procedure will appear.
3. Press **OK** to accept the default values for standard concentration, sample volume, and spike volumes. Press **EDIT** to change these values. After values are accepted, the unspiked sample reading will appear in the top row. See the user manual for more information.
4. Snap the neck off a Phosphate Voluette® Ampule Standard Solution, 500-mg/L as PO₄³⁻.
5. Prepare three sample spikes. Fill three mixing cylinders* with 25 mL of sample. Use the TenSette® Pipet to add 0.1 mL, 0.2 mL, and 0.3 mL of standard, respectively, to each sample and mix thoroughly.
6. Analyze each sample spike as described in the procedure above, starting with the 0.1 mL sample spike. Accept each standard additions reading by pressing **READ**. Each addition should reflect approximately 100% recovery.
7. After completing the sequence, press **GRAPH** to view the best-fit line through the standard additions data points, accounting for matrix interferences. Press **IDEAL LINE** to view the relationship between the sample spikes and the “Ideal Line” of 100% recovery.

* See [Optional Reagents and Apparatus on page 5](#).

† [Optional Reagents and Apparatus on page 5](#).

Standard Solution Method

1. Use a 10.0-mg/L Phosphate Standard in place of the sample.
2. To adjust the calibration curve using the reading obtained with the 10-mg/L PO₄³⁻ Phosphate Standard Solution, press **OPTIONS>MORE** on the current program menu. Press **STANDARD ADJUST**.
3. Press **ON**. Press **ADJUST** to accept the displayed concentration (the value depends on the selected chemical form). If an alternate concentration is used, press the number in the box to enter the actual concentration, then press **OK**. Press **ADJUST**.

Summary of Method

In the molybdovanadate method, orthophosphate reacts with molybdate in an acid medium to produce a phosphomolybdate complex. In the presence of vanadium, yellow vanadomolybdophosphoric acid is formed. The intensity of the yellow color is proportional to the phosphate concentration. Test results are measured at 430 nm.

Consumables and Replacement Items**Required Reagents**

Description	Quantity/Test	Unit	Cat. No.
Molybdovanadate Reagent	2	500 mL	20760-49
Water, deionized	25	4 L	272-56

Required Apparatus

Description	Quantity/Test	Unit	Cat. No.
Adapter, for Multi-path and Pour-Thru cells	1	each	LZV585
Cylinder, graduated, 25-mL, poly	1	each	1081-40
Dispenser, fixed volume, 1.0-mL, w/bottle	1	each	21113-02
Flask, Erlenmeyer, 125-mL, PMP w/cap	2	each	20898-43
Pour-Thru Cell Module Assembly	1	each	59404-00

Recommended Standards

Description	Unit	Cat. No.
Phosphate Standard Solution, 10-mg/L as PO ₄ ³⁻	946 mL	14204-16
Phosphate Standard Solution, Voluette® ampule, 10-mL, 500-mg/L as PO ₄ ³⁻	16/pkg	14242-10
Wastewater Influent Standard for NH ₃ -N, NO ₃ -N, PO ₄ , COD, SO ₄ , TOC	500 mL	28331-49

Optional Reagents and Apparatus

Description	Cat. No.
Ammonium Hydroxide, 500 mL	106-49
Bromine Water, 29 mL	2211-20
Cylinder, mixing, 25 mL	1896-40
Hydrochloric Acid Solution, 1:1, 500 mL	884-49
Phenol Solution, 29 mL	2112-20



FOR TECHNICAL ASSISTANCE, PRICE INFORMATION AND ORDERING:

In the U.S.A. – Call toll-free 800-227-4224
Outside the U.S.A. – Contact the HACH office or distributor serving you.
On the Worldwide Web – www.hach.com; E-mail – techhelp@hach.com

HACH COMPANY
WORLD HEADQUARTERS
Telephone: (970) 669-3050
FAX: (970) 669-2932

Phosphorus, Reactive (Orthophosphate)

Method 8114

Molybdovanadate Method¹

Reagent Solution or AccuVac[®] Ampuls

(0.3 to 45.0 mg/L PO₄³⁻)

Scope and Application: For water and wastewater

¹ Adapted from *Standard Methods for the Examination of Water and Wastewater*.



Test Preparation

Before starting the test:

For best results, sample temperature should be 20–25 °C (68–77 °F).

After adding reagent, a yellow color will form if phosphate is present. The blank will be slightly yellow because of the reagent.

Collect the following items:

Quantity

Collect the following items:	Quantity
Liquid Reagent Test:	
Cylinder, graduated, 25-mL	1
Molybdovanadate Reagent	2.0 mL
Sample Cells, 1-inch square, 10-mL	2
AccuVac Test:	
Molybdovanadate Reagent AccuVac [®] Ampuls	2
Beaker, 50-mL	2
Stopper for 18 mm Tube	2

Note: Reorder information for consumables and replacement items is on page 6.

Reagent Solution

Method 8114



1. Press **STORED PROGRAMS**.

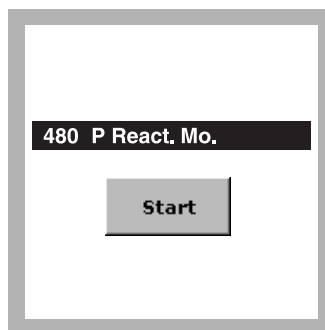

2. Select the test.

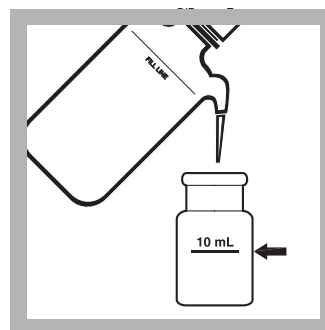

3. **Blank Preparation:** Fill a square sample cell with 10 mL of deionized water.

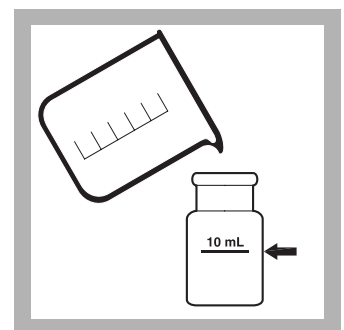

4. **Prepared Sample:** Fill a second square sample cell with 10 mL of sample.

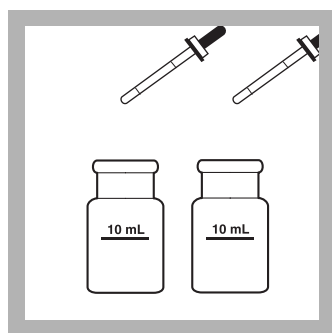

5. Add 0.5 mL of Molybdovanadate Reagent to each sample cell. Swirl to mix.

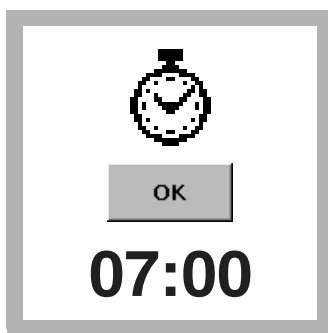

6. Press **TIMER>OK**.
A 7-minute reaction period will begin.
If the sample concentration is greater than 30 mg/L PO₄³⁻, read at exactly seven minutes, or make a 1:1 dilution of the sample and repeat the test.



7. When the timer expires, wipe the blank and insert it into the cell holder with the fill line facing right.
Press **ZERO**.
The display will show:
0.0 mg/L PO₄³⁻

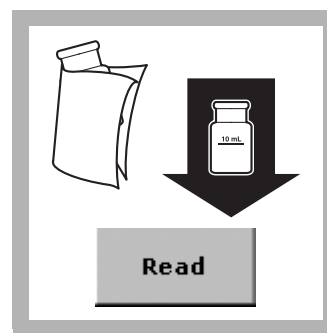

8. Wipe the prepared sample and insert it into the cell holder with the fill line facing right.
Press **READ**. Results are in mg/L PO₄³⁻.

AccuVac Ampul

Method 8114

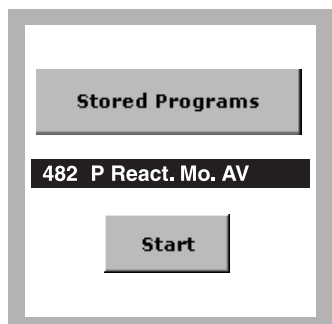

1. Select the test.

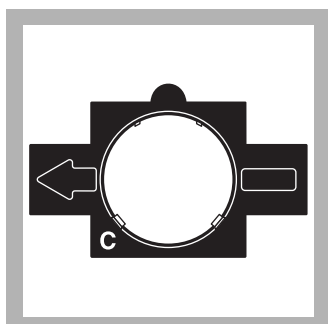

2. Insert Adapter C.

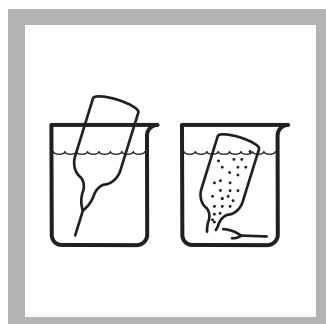

3. **Prepared Sample:**
Collect 40 mL of sample in one 50-mL beaker. Fill a Molybdovanadate Reagent AccuVac Ampul with sample.

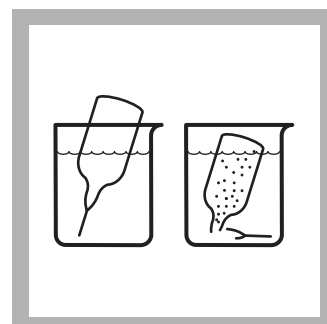

4. **Blank Preparation:**
Collect 40 mL of deionized water in another 50-mL beaker.
Fill another Ampul with deionized water. Keep the tips immersed while the Ampuls fill completely.



5. Press **TIMER>OK.**

A 7-minute reaction period will begin.

If the sample concentration is greater than 30 mg/L PO₄³⁻, read at exactly seven minutes, or make a 1:1 dilution of the sample and repeat the test.

6. When the timer expires, wipe the blank and insert it into the cell holder.

7. Press **ZERO.**
The display will show:
0.0 mg/L PO₄³⁻

8. Wipe the prepared sample and insert it into the cell holder.

Press **READ**. Results are in mg/L PO₄³⁻.

Interferences

Table 1 Interfering Substances and Levels

Interfering Substance	Interference Levels and Treatments
Arsenate	Only interferes if sample is heated.
Iron, ferrous	Blue color caused by ferrous iron does not interfere if concentration is less than 100 mg/L.
Molybdate	Causes negative interference above 1000 mg/L.
Silica	Only interferes if sample is heated.
Sulfide	Causes a negative interference. <ol style="list-style-type: none"> 1. Measure 50 mL of sample into an Erlenmeyer flask. 2. Add Bromine Water¹ drop-wise with constant swirling until a permanent yellow color develops. 3. Add Phenol Solution¹ drop-wise until the yellow color just disappears. Proceed with step 4 (step 3 if using AccuVac procedure).
pH, extreme or highly buffered samples	May exceed buffering capacity of reagents. May require pretreatment. pH should be about 7.
Fluoride, thorium, bismuth, thiosulfate or thiocyanate	Cause negative interference.

¹ See [Optional Reagents and Apparatus on page 6](#).

Table 2 shows substances that do not interfere in concentrations less than 1000 mg/L.

Table 2 Noninterfering at Low Concentrations

Pyrophosphate	Tetraborate	Benzoate
Citrate	Lactate	Formate
Oxalate	Tartrate	Salicylate
Al ³⁺	Fe ³⁺	Mg ²⁺
Ca ²⁺	Ba ²⁺	Sr ²⁺
Li ⁺	Na ⁺	K ⁺
NH ₄ ⁺	Cd ²⁺	Mn ²⁺
NO ₃ ⁻	NO ₂ ⁻	SO ₄ ²⁻
SO ₃ ²⁻	Pb ²⁺	Hg ⁺
Hg ²⁺	Sn ²⁺	Cu ²⁺
Ni ²⁺	Ag ⁺	U ⁴⁺
Zr ⁴⁺	AsO ₃ ⁻	Br ⁻
CO ₃ ²⁻	ClO ₄ ⁻	CN ⁻
IO ₃ ⁻	SiO ₄ ⁴⁻	Selenate

Sample Collection, Storage, and Preservation

Collect samples in clean plastic or glass bottles that have been cleaned with 1:1 Hydrochloric Acid Solution* and rinsed with deionized water. Do not use a commercial detergent because the phosphate content will contaminate the sample.

Analyze samples as soon as possible for best results. If samples cannot be analyzed promptly, store the sample for up to 48 hours at 4 °C (39 °F) or below. Warm to room temperature before analyzing.

Accuracy Check

Standard Additions Method (Sample Spike)

1. After reading test results, leave the sample cell (unspiked sample) in the instrument. Verify the chemical form.
2. Press **OPTIONS>MORE**. Press **STANDARD ADDITIONS**. A summary of the standard additions procedure will appear.
3. Press **OK** to accept the default values for standard concentration, sample volume, and spike volumes. Press **EDIT** to change these values. After values are accepted, the unspiked sample reading will appear in the top row. See the user manual for more information.
4. Snap the neck off a Phosphate 2-mL Ampule Standard, 500-mg/L PO₄³⁻.
5. Prepare three sample spikes. Fill three mixing cylinders* with 25 mL of sample. Use the TenSette® Pipet to add 0.1 mL, 0.2 mL, and 0.3 mL of standard, respectively, to each sample and mix thoroughly.

* See [Optional Reagents and Apparatus](#) on page 6.

6. Analyze each sample spike as described in the procedure above, starting with the 0.1 mL sample spike. Accept each standard additions reading by pressing **READ**. Each addition should reflect approximately 100% recovery.
7. After completing the sequence, press **GRAPH** to view the best-fit line through the standard additions data points, accounting for the matrix interferences. Press **IDEAL LINE** to view the relationship between the sample spikes and the "Ideal Line" of 100% recovery.

Standard Solution Method

1. Use a 10-mg/L phosphate standard solution in place of the sample. Perform the molybdovanadate procedure as described above.
2. To adjust the calibration curve using the reading obtained with the standard solution, press **OPTIONS>MORE** on the current program menu. Press **STANDARD ADJUST**.
3. Press **ON**. Press **ADJUST** to accept the displayed concentration. If an alternate concentration is used, press the number in the box to enter the actual concentration, then press **OK**. Press **ADJUST**.

Summary of Method

In the molybdovanadate method, orthophosphate reacts with molybdate in an acid medium to produce a mixed phosphate/molybdate complex. In the presence of vanadium, yellow molybdovanadophosphoric acid is formed. The intensity of the yellow color is proportional to the phosphate concentration. Test results are measured at 430 nm.

Phosphorus, Reactive (Orthophosphate) (0.3 to 45.0 mg/L PO₄³⁻)

Consumables and Replacement Items

Required Reagents

Description	Quantity/Test	Unit	Cat. No.
Molybdovanadate Reagent	1.0 mL	100 mL MDB	20760-32
OR			
Molybdovanadate Reagent AccuVac® Ampuls	2	25/pkg	25250-25
Water, deionized	25 mL	4 L	272-56

Required Apparatus (Liquid Reagent)

Description	Quantity/Test	Unit	Cat. No.
Cylinder, graduated, 25-mL	1	each	508-40
Sample Cells, 1-inch square, 10 mL, matched pair	2	2/pkg	24954-02
Stopper for 18 mm Tube	2	6/pkg	1731-06

Required Apparatus (AccuVac)

Description	Quantity/Test	Unit	Cat. No.
Adapter, 1-inch round, for AccuVac Ampuls	1	each	LZV584
Beaker, 50-mL	1	each	500-41H

Recommended Standards

Description	Unit	Cat. No.
Phosphate Standard Solution, 10-mg/L as PO ₄ ³⁻	946 mL	14204-16
Phosphate Standard Solution, 2-mL PourRite® Ampule, 500 mg/L as PO ₄ ³⁻	20/pkg	14242-20
Wastewater Influent Standard, for mixed parameters NH ₃ -N, NO ₃ -N, PO ₄ , COD, SO ₄ , TOC	500 mL	28331-49

Optional Reagents and Apparatus

Description	Cat. No.
Bromine Water, 29 mL	2211-20
Cylinder, mixing, 25 mL	1896-40
Hydrochloric Acid, 1:1, 500 mL	884-49
Phenol Solution, 30 g/L, 29 mL	2112-20
Stopper for 18 mm Tube, 25/pkg	1731-25



FOR TECHNICAL ASSISTANCE, PRICE INFORMATION AND ORDERING:
In the U.S.A. – Call toll-free 800-227-4224
Outside the U.S.A. – Contact the HACH office or distributor serving you.
On the Worldwide Web – www.hach.com; E-mail – techhelp@hach.com

HACH COMPANY
WORLD HEADQUARTERS
Telephone: (970) 669-3050
FAX: (970) 669-2932

Phosphorus, Reactive (Orthophosphate)

Method 8114

Molybdovanadate Method¹

Test 'N Tube™ Vials

HR (1.0 to 100.0 mg/L PO₄³⁻)

Scope and Application: For water and wastewater.

¹ Adapted from *Standard Methods for the Examination of Water and Wastewater*



Test Preparation

Before starting the test:

Important Note: Install the light shield in Cell Compartment #2 before performing this test.

Reagent blanks for each lot of reagents may be used more than once. At room temperature, the reagent blank is stable for up to three weeks.

The seven-minute reaction time in step 5 is for samples at 23 °C. For samples at 13 °C, wait 15 minutes. For samples at 33 °C, wait two minutes.

Final samples will contain molybdenum. In addition, final samples will have a pH less than 2 and are considered corrosive (D002) by the Federal RCRA. Refer to the current MSDS for safe handling and disposal information.

Collect the following items:

Quantity

High Range Reactive Phosphorus Test 'N Tube Vials	1
Water, deionized	5 mL
Dropper, LDPE, 0.5–1.0 mL	1
Light Shield	1
Pipet, TenSette®, 1 to 10 mL	1
Pipet Tips, for TenSette Pipet	1
Test Tube Rack	1–3

Note: Reorder information for consumables and replacement items is on page 5.

Test 'N Tube Method 8114

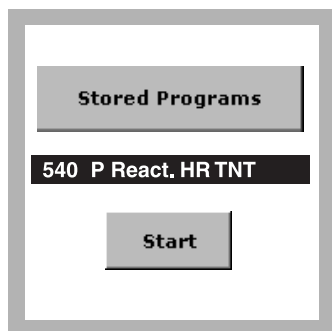

1. Select the test.
Install the Light Shield in Cell Compartment #2.

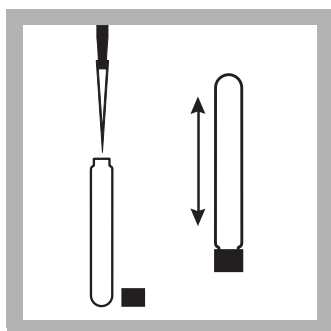

2. **Blank Preparation:**
Use a TenSette® Pipet to add 5.0 mL of deionized water to a Reactive High Range Phosphorus Test 'N Tube Vial.
Cap and invert to mix.

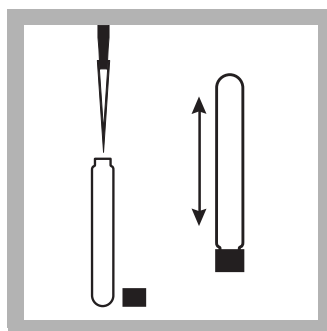

3. **Prepared Sample:**
Use a TenSette Pipet to add 5.0 mL of sample to a Reactive High Range Phosphorus Test 'N Tube Vial.
Cap and invert to mix.

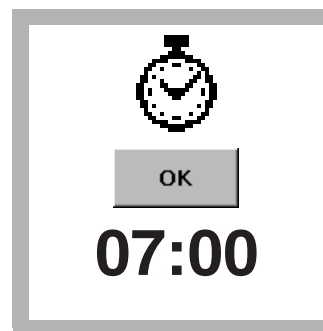

4. Press **TIMER>OK**.
A seven-minute reaction period will begin.
Read the sample within two minutes after the timer expires.

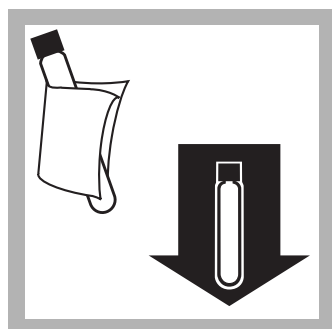

5. Wipe the reagent blank and insert it into the 16-mm round cell holder.

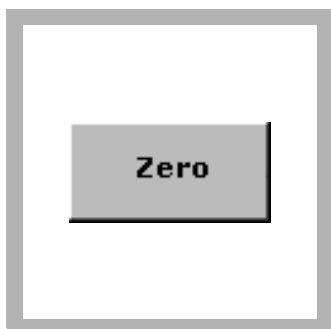

6. Press **ZERO**.
The display will show:
0.0 mg/L PO₄³⁻

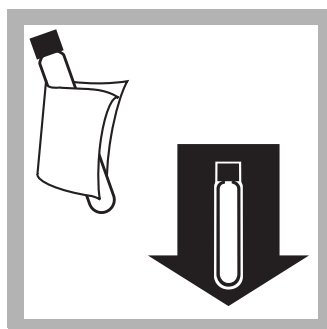

7. Wipe the prepared sample vial and insert it into the 16-mm round cell holder.

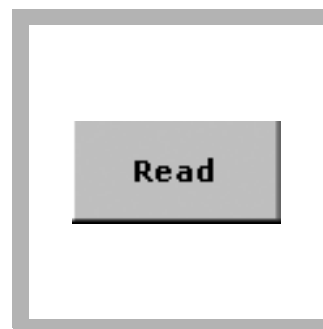

8. Press **READ**.
Results are in mg/L PO₄³⁻.

Interferences

Table 1 Interfering Substances and Levels

Interfering Substance	Interference Levels and Treatments
Arsenate	Only interferes if the sample is heated. ¹
Iron, ferrous	Blue color caused by ferrous iron does not interfere if iron concentration is less than 100 mg/L.
Molybdate	Causes negative interference above 1000 mg/L.
Silica	Only interferes if the sample is heated. ¹
Sulfide	Causes a negative interference. Remove interference as follows: 1. Measure 25 mL of sample into a 50-mL beaker. 2. Add Bromine Water ² drop-wise with constant swirling until a permanent yellow color develops. 3. Add Phenol Solution ² drop-wise until the yellow color just disappears. Proceed with <i>step 1</i> .

Table 1 Interfering Substances and Levels (continued)

Interfering Substance	Interference Levels and Treatments
Extreme pH or highly buffered samples	May exceed buffering capacity of the reagents. Samples may require pretreatment. Sample pH should be about 7.
Fluoride, thorium, bismuth, thiosulfate or thiocyanate	Cause a negative interference.
Temperature, Cold (less than 20 °C)	Causes a negative interference.
Temperature, Hot (greater than 25 °C)	Causes a positive interference.

¹ Gentle warming of the sample to room temperature will not prevent this substance from interfering.

² See [Optional Reagents and Apparatus on page 5](#).

Table 2 shows substances that do not interfere in concentrations less than 1000 mg/L.

Table 2 Noninterfering at Low Concentrations

Pyrophosphate	Tetraborate	Benzoate
Citrate	Lactate	Formate
Oxalate	Tartrate	Salicylate
Al ³⁺	Selenate	Mg ²⁺
Ca ²⁺	Ba ²⁺	Sr ²⁺
Li ⁺	Na ⁺	K ⁺
NH ₄ ⁺	Cd ²⁺	Mn ²⁺
NO ₃ ⁻	NO ₂ ⁻	SO ₄ ²⁻
SO ₃ ²⁻	Pb ²⁺	Hg ⁺
Hg ²⁺	Sn ²⁺	Cu ²⁺
Ni ²⁺	Ag ⁺	U
Zr ⁴⁺	AsO ₃ ⁻	Br ⁻
CO ₃ ²⁻	ClO ₄ ⁻	CN ⁻
IO ₃ ⁻	Fe ³⁺	SiO ₄ ⁴⁻

Sample Collection, Storage, and Preservation

Collect samples in plastic or glass bottles that have been cleaned with 1:1 Hydrochloric Acid Solution* and rinsed with deionized water. Do not use commercial detergents containing phosphate for cleaning glassware used in this test.

For best results, analyze the samples immediately after collection. If prompt analysis is impossible, preserve the samples for up to 48 hours by filtering immediately and storing at 4 °C. The sample should be at room temperature before analysis.

* See [Optional Reagents and Apparatus on page 5](#).

Accuracy Check

Standard Additions Method (Sample Spike)

1. Clean glassware with 1:1 hydrochloric acid solution. Rinse again with deionized water. Do not use detergents containing phosphate to clean glassware.
2. After reading test results, leave the sample cell (unspiked sample) in the instrument. Verify the chemical form.
3. Press **OPTIONS>MORE**. Press **STANDARD ADDITIONS**. A summary of the standard additions procedure will appear.
4. Press **OK** to accept the default values for standard concentration, sample volume, and spike volumes. Press **EDIT** to change these values. After values are accepted, the unspiked sample reading will appear in the top row. See the user manual for more information.
5. Snap the neck off a 10-mL Voluette® Ampule of Phosphate Standard Solution, 500-mg/L PO₄³⁻.
6. Prepare three sample spikes. Fill three mixing cylinders with 10 mL of sample. Use the TenSette Pipet to add 0.1, 0.2 mL, and 0.3 mL of standard, respectively to each sample and mix thoroughly.
7. Analyze each sample spike as described in the procedure above, starting with the 0.1 mL sample spike. Accept each standard additions reading by pressing **READ**. Each addition should reflect approximately 100% recovery.
8. After completing the sequence, press **GRAPH** to view the best-fit line through the standard additions data points, accounting for matrix interferences. Press **V IDEAL LINE** to view the relationship between the sample spikes and the “Ideal Line” of 100% recovery.

Standard Solution Method

1. Use a 50-mg/L PO₄³⁻ standard in place of the sample. Perform this procedure as described.
2. To adjust the calibration curve using the reading obtained with the 50-mg/L PO₄³⁻ phosphate standard solution, press **OPTIONS>MORE** on the current program menu. Press **STANDARD ADJUST**.
3. Press **ON**. Press **ADJUST** to accept the displayed concentration (the value depends on the selected chemical form). If an alternate concentration is used, press the number in the box to enter the actual concentration, then press **OK**. Press **ADJUST**.

Summary of Method

Orthophosphate reacts with molybdate in an acid medium to produce a mixed phosphate/molybdate complex. In the presence of vanadium, yellow molybdovanadophosphoric acid forms. The intensity of the yellow color is proportional to the phosphate concentration. Test results are measured at 420 nm.

Consumables and Replacement Items

Required Reagents

Description	Quantity/Test	Unit	Cat. No.
High Range Reactive Phosphorus Test 'N Tube™ Reagent Set, includes:	—	50 vials	27673-45
(1) Reactive High Range Phosphorus Test 'N Tube Vials ¹	1	50/pkg	—
(2) Water, deionized	5 mL	100 mL	272-42

¹ Not available separately.

Required Apparatus

Description	Quantity/Test	Unit	Cat. No.
Dropper, LDPE, 0.5–1.0 mL	1	20/pkg	21247-20
Light Shield	1	each	LZV646
Pipet, TenSette®, 1 to 10 mL	1	each	19700-10
Pipet Tips, for TenSette Pipet 19700-10	1	50/pkg	21997-96
Test Tube Rack	1–3	each	18641-00

Recommended Standards

Description	Unit	Cat. No.
Phosphate Standard Solution, 50-mg/L, as PO ₄ ³⁻	500 mL	171-49
Phosphate Standard Solution, Voluette® ampule, 500-mg/L as PO ₄ ³⁻ , 10-mL	16/pkg	14242-10
Wastewater Influent Standard for NH ₃ -N, NO ₃ -N, PO ₄ , COD, SO ₄ , TOC	500 mL	28331-49

Optional Reagents and Apparatus

Description	Unit	Cat. No.
Ammonium Hydroxide	500 mL	106-49
Bromine Water	29 mL	2211-20
Cylinder, mixing	25 mL	1896-40
Hydrochloric Acid Solution, 1:1	500 mL	884-49
Phenol Solution	29 mL	2112-20



FOR TECHNICAL ASSISTANCE, PRICE INFORMATION AND ORDERING:

In the U.S.A. – Call toll-free 800-227-4224
Outside the U.S.A. – Contact the HACH office or distributor serving you.
On the Worldwide Web – www.hach.com; E-mail – techhelp@hach.com

HACH COMPANY
WORLD HEADQUARTERS
Telephone: (970) 669-3050
FAX: (970) 669-2932

Phosphorus, Reactive

Method 10055

Ascorbic Acid Rapid Liquid Method¹

Pour-Thru Cell

LR (19 to 3000 µg/L PO₄³⁻)

Scope and Application: For treated and natural waters

¹ Adapted from *Standard Methods for the Examination of Water and Wastewater*.



Test Preparation

Before starting the test:

See the user manual for Pour-Thru Module installation instructions.

Clean the Pour-Thru cell and all labware as specified in [Treating Analysis Labware on page 3](#).

Protect the Pour-Thru Cell from contamination when not in use by inverting a small beaker over the top of the glass funnel.

See [Reagent Preparation on page 3](#) for preparing the Ascorbic Acid reagent.

Reaction time depends on sample temperature. For most accurate results, samples should be at room temperature (about 20 °C).

Obtain a reagent blank for each lot of reagent when the normal sample phosphate concentration is less than 750 µg/L. Follow the procedure using deionized water in place of the sample. Subtract the reagent blank value from the final results.

Collect the following items:

Quantity

Ascorbic Acid Reagent Dilution Solution	1 mL
Ascorbic Acid Reagent Powder	varies
Cylinder, graduated, 25-mL, poly	2
Dispenser, fixed volume, 1.0-mL w/bottle	2
Flask, Erlenmeyer, 125-mL, PMP w/cap	2
Molybdate Reagent Solution	2 mL
Pour-Thru Cell Assembly	1
Water, deionized	varies

Note: Reorder information for consumables and replacement items is on [page 5](#).

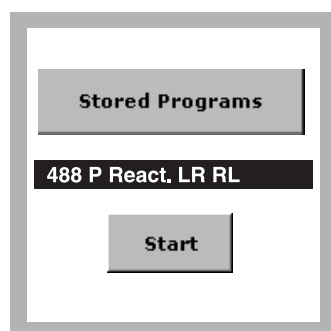

1. Select the test.

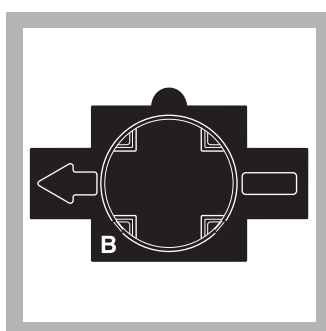

2. Insert Adapter B. Install the Pour-Thru Cell with the 1-inch (round) path in line with the adapter arrow. Flush the Pour-Thru Cell with 50 mL of deionized water.

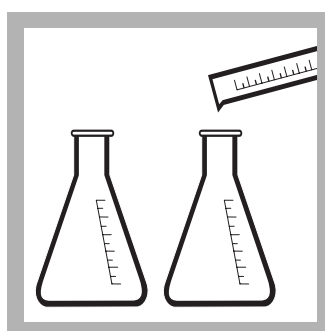

3. Rinse two clean Erlenmeyer flasks three times with the sample.

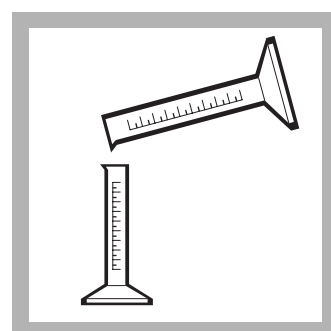

4. Rinse a clean 25-mL plastic graduated cylinder three times with the sample.

Pour-Thru Cell

Method 10055

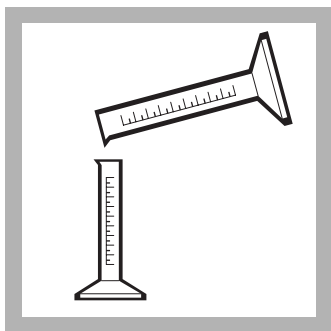

5. Fill the rinsed cylinder to the 25-mL mark with sample.

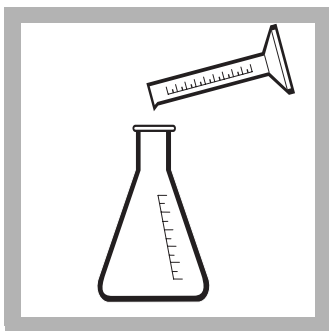

6. Pour the contents of the 25-mL cylinder into one of the flasks.

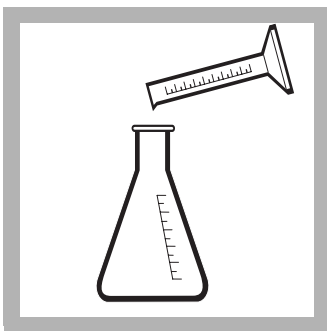

7. Measure a second 25-mL portion of sample into the graduated cylinder and pour the contents into the second flask.



8. Add 1.0 mL of Molybdate reagent to each flask using a Repipet Jr. Dispenser. Swirl to mix.

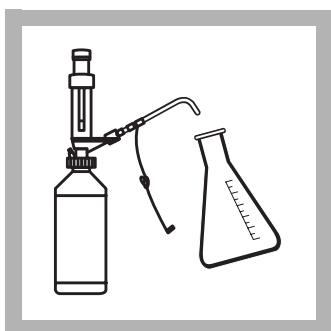

9. **Prepared Sample:** Add 1.0 mL of prepared Ascorbic Acid reagent to one of the flasks with a Repipet Jr. Dispenser. Swirl to mix. The remaining flask will be the blank.



10. Press **TIMER>OK**. A five-minute reaction period will begin.

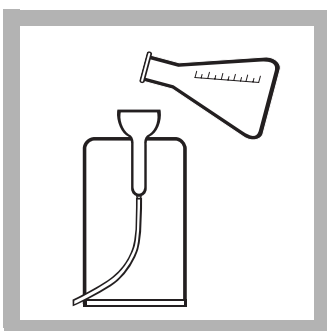

11. When the timer expires, pour the contents of the flask that contains the blank into the Pour-Thru Cell.

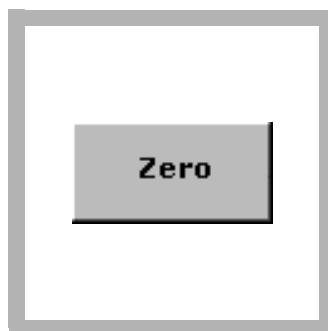

12. After the flow stops, press **ZERO**. The display will show:
0 µg/L PO₄³⁻

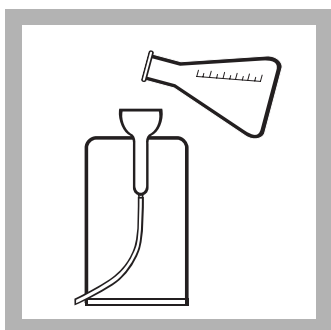

13. Pour the prepared sample into the Pour-Thru Cell. Press **READ**. Results are in µg/L PO₄³⁻.

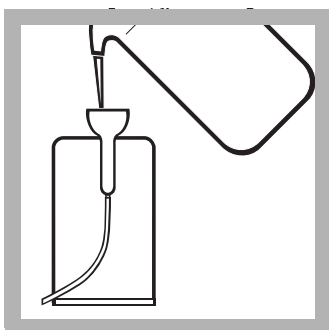

14. Flush the Pour-Thru Cell with at least 50 mL of deionized water immediately after use.

Interferences

Table 1 Interfering Substances and Levels

Interfering Substance	Interference Levels and Treatments
Aluminum	200 mg/L
Arsenate	Interferes
Chromium	100 mg/L
Copper	10 mg/L
Hydrogen sulfide	Interferes
Iron	100 mg/L
Nickel	300 mg/L
Silica	50 mg/L
Silicate	10 mg/L
Turbidity	Samples with large amounts of turbidity may give inconsistent results because the acid present in the reagents may dissolve some of the suspended particles and variable desorption of orthophosphate from the particles may occur.
Zinc	80 mg/L
Highly buffered samples or extreme sample pH	May exceed the buffering capacity of the reagents and require sample pretreatment.

Treating Analysis Labware

All labware used in this test must be thoroughly cleaned to remove all traces of phosphate. Clean containers with a non-phosphate detergent followed by a rinse with deionized water. Fill and soak for 10 minutes with a 1:25 dilution of Molybdate Reagent in deionized water. Rinse well with deionized water. Keep containers tightly closed when not in use. Treat the Pour-Thru Cell with this same mixture of molybdate and water followed by thorough rinsing with deionized water.

Dedicate these containers for low-level phosphate analysis. If these containers are rinsed and capped after use, only occasional pre-treatment is necessary.

Cleaning the Pour-Thru Cell

The Pour-Thru Cell may accumulate a buildup of colored products, especially if the reacted solutions are allowed to stand in the cell for long periods after measurement. Remove the color by rinsing with a 1:5 dilution of Ammonium Hydroxide*, followed by several deionized water rinses. Invert a beaker over the glass funnel of the cell when not in use.

Reagent Preparation

The Ascorbic Acid reagent must be prepared before use. Using a powder funnel, add the contents of one 48 g bottle of Ascorbic Acid Reagent Powder* to one 450 mL bottle of Ascorbic Acid Reagent Dilution Solution*. Invert several times and swirl until the powder is completely dissolved. Attach Repipet Jr Dispensers to the top of this bottle and the Molybdate Reagent bottle.

This solution may develop a yellow color with time but will still give accurate results for up to one month after mixing if stored at 20–25 °C. Record the date of preparation on the bottle and discard any remaining solution after one month. Do not add fresh reagent to previously mixed reagent. Use of this reagent after one month may result in high reagent blanks and low values at high concentrations.

* See [Optional Reagents and Apparatus on page 5](#).

Sampling and Storage

Collect samples in clean plastic or glass bottles that have been cleaned with 1:1 Hydrochloric Acid Solution* and rinsed with deionized water. Do not use detergents that contain phosphate for cleaning labware.

Analyze samples immediately for best results. If prompt analysis is not possible, preserve samples by filtering immediately and storing at 4 °C (39 °F) for up to 48 hours.

Accuracy Check

Standard Additions Method (Sample Spike)

1. After reading test results, leave the sample cell (unspiked sample) in the instrument. Verify the chemical form.
2. Press **OPTIONS>MORE**. Press **STANDARD ADDITIONS**. A summary of the standard additions procedure will appear.
3. Press **OK** to accept the default values for standard concentration, sample volume, and spike volumes. Press **EDIT** to change these values. After values are accepted, the unspiked sample reading will appear in the top row. See the user manual for more information.
4. Snap the neck off a Phosphate Standard Solution Ampule, either 15-mg/L (15,000 µg/L) as PO₄³⁻ or 50-mg/L (50,000 µg/L) as PO₄³⁻. Use the 15-mg/L standard when the phosphate concentration of samples is less than 1000 µg/L. Be sure the correct standard concentration is set in step 3, above.
5. Prepare three sample spikes. Fill three Mixing Cylinders* with 25 mL of sample. Use the TenSette® Pipet to add 0.1 mL, 0.2 mL, and 0.3 mL of standard, respectively, to each sample and mix thoroughly.
6. Analyze each sample spike as described in the procedure above, starting with the 0.1 mL sample spike. Accept each standard additions reading by pressing **READ**. Each addition should reflect approximately 100% recovery.
7. After completing the sequence, press **GRAPH** to view the best-fit line through the standard additions data points, accounting for matrix interferences. Press **IDEAL LINE** to view the relationship between the sample spikes and the "Ideal Line" of 100% recovery.

Standard Solution Method

1. Run the test using a 1000-µg/L (1.000-mg/L) phosphate standard solution in place of the sample.
2. To adjust the calibration curve using the reading obtained with the standard solution, press **OPTIONS>MORE** on the current program menu. Press **STANDARD ADJUST**.
3. Press **ON**. Press **ADJUST** to accept the displayed concentration (the value depends on the selected chemical form). If an alternate concentration is used, press the number in the box to enter the actual concentration, then press **OK**. Press **ADJUST**.

Summary of Method

Orthophosphate reacts with molybdate in an acid medium to produce a phosphomolybdate complex. Ascorbic acid then reduces the complex, giving an intense molybdenum blue color. Reactive phosphorus includes existing orthophosphate in the sample plus a small fraction of condensed phosphate that may be hydrolyzed to orthophosphate during the test. Test results are measured at 880 nm.

Consumables and Replacement Items

Required Reagents

Description	Quantity/Test	Unit	Cat. No.
Rapid Liquid Low Range Phosphorus Reagent Set, includes:			26786-00
Ascorbic Acid Reagent Dilution Solution	1 mL	450 mL	25999-49
Ascorbic Acid Reagent Powder	varies	48 g	26512-55
Molybdate Reagent Solution	2 mL	500 mL	25998-49
Water, deionized	varies	4 L	272-56

Required Apparatus

Description	Quantity	Unit	Cat. No.
Adapter, for Multi-path and Pour-Thru cells	1	each	LZV585
Cylinder, graduated, 25-mL, poly	2	each	1081-40
Dispenser, fixed volume, 1.0-mL w/bottle	2	each	21113-02
Flask, Erlenmeyer, 125-mL, PMP w/cap	2	each	20898-43
Pour-Thru Cell Assembly	1	each	59404-00

Recommended Standards

Description	Unit	Cat. No.
Drinking Water Standard, mixed Inorganics for NO ₃ , PO ₄ , SO ₄	500 mL	28330-49
Phosphate Standard Solution, 1.00-mg/L as PO ₄ ³⁻	500 mL	2569-49
Phosphate Standard Solution, 3-mg/L as PO ₄ ³⁻	946 mL	20597-16
Phosphate Standard Solution, Voluette® ampule, 10-mL, 50-mg/L PO ₄ ³⁻	16/pkg	171-10
Phosphate Standard Solution, 15-mg/L PO ₄ ³⁻	100 mL	14243-42
Wastewater Effluent Standard for NH ₃ -N, NO ₃ -N, PO ₄ , COD, SO ₄ , TOC	500 mL	28332-49

Optional Reagents and Apparatus

Description	Cat. No.
Ammonium Hydroxide, 500 mL	106-49
Cylinder, mixing, 25 mL	1896-40
Hydrochloric Acid Solution, 1:1, 500 mL	884-49



FOR TECHNICAL ASSISTANCE, PRICE INFORMATION AND ORDERING:

In the U.S.A. – Call toll-free 800-227-4224
Outside the U.S.A. – Contact the HACH office or distributor serving you.
On the Worldwide Web – www.hach.com; E-mail – techhelp@hach.com

HACH COMPANY
WORLD HEADQUARTERS
Telephone: (970) 669-3050
FAX: (970) 669-2932

Phosphorus, Reactive (Orthophosphate)

★Method 8048

PhosVer 3 (Ascorbic Acid) Method¹

Powder Pillows or AccuVac[®] Ampuls

(0.02 to 2.50 mg/L PO₄³⁻)

Scope and Application: For water, wastewater, and seawater; USEPA Accepted for reporting for wastewater analyses²

¹ Adapted from *Standard Methods for the Examination of Water and Wastewater*

² Procedure is equivalent to USEPA method 365.2 and Standard Method 4500-P-E for wastewater.



Test Preparation

Before starting the test:

For more accurate results, determine a reagent blank value for each new lot of reagent. Follow the procedure using deionized water instead of the sample. Subtract the reagent blank value from the final results or perform a reagent blank adjust.

Collect the following items:

Quantity

Collect the following items:	Quantity
Powder Pillow Test:	
PhosVer [®] 3 Phosphate Reagent powder pillow	1
Sample Cells, 1-in. square, 10-mL	2
Stopper for 18 mm Tube	1
AccuVac Test:	
Collect at least 40 mL of sample in a 50-mL beaker	40 mL
PhosVer [®] 3 Phosphate Reagent AccuVac [®] Ampul	1
Beaker, 50-mL	1
Sample Cell, 10-mL round	1
Stopper for 18-mm Tube (supplied with PhosVer AccuVacs)	1

Note: Reorder information for consumables and replacement items is on page 6.

Note: A blue color will develop if phosphorus is present.

Powder Pillows

Method 8048



1. Press **STORED PROGRAMS**.

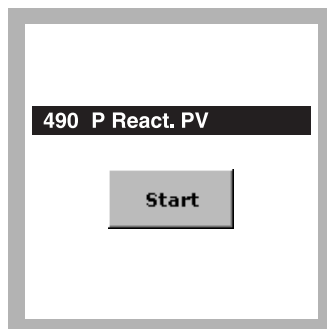

2. Select the test.

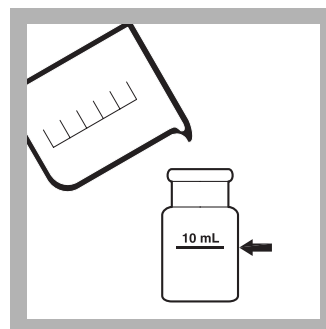

3. Fill a square sample cell with 10-mL of sample.

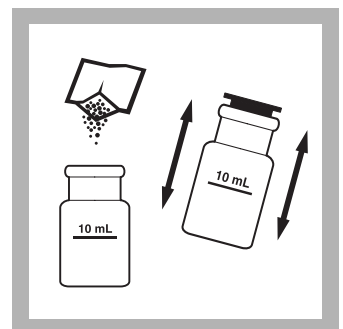

4. **Prepared Sample:** Add the contents of one PhosVer 3 phosphate Powder Pillow to the cell. Immediately stopper and shake vigorously for 30 seconds.

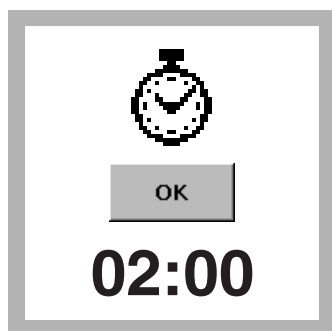

5. Press TIMER>OK.

A two-minute reaction period will begin. If the sample was digested using the Acid Persulfate digestion, a ten-minute reaction period is required.

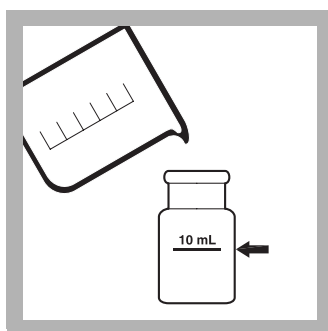

6. Blank Preparation:

Fill a second square sample cell with 10 mL of sample.

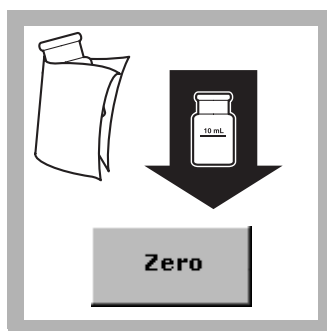

7. When the timer expires, wipe the blank and insert it into the cell holder with the fill line facing right.

Press **ZERO**. The display will show:

0.00 mg/L PO₄³⁻

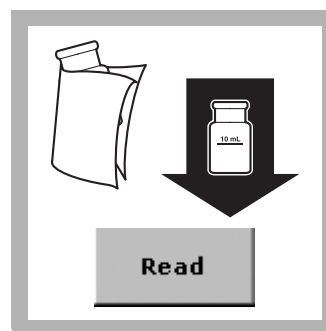

8. Wipe the prepared sample and insert it into the cell holder with the fill line facing right.

Press **READ**. Results are in mg/L PO₄³⁻.

AccuVac® Ampul

Method 8048

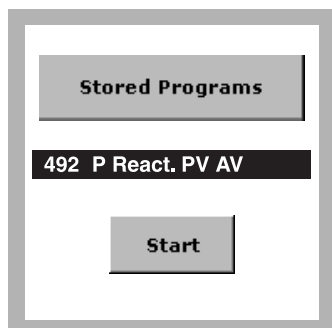

1. Select the test.

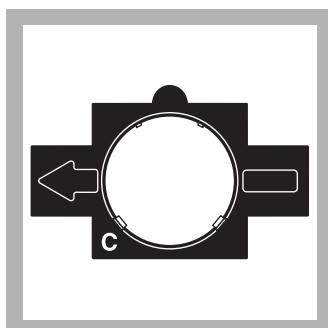

2. Insert Adapter C.

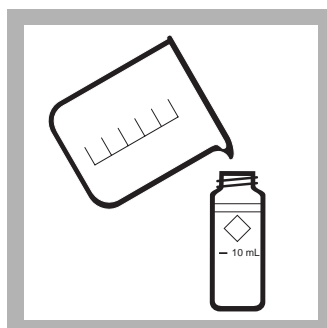

3. Blank Preparation:

Fill a round sample cell with 10-mL of sample.

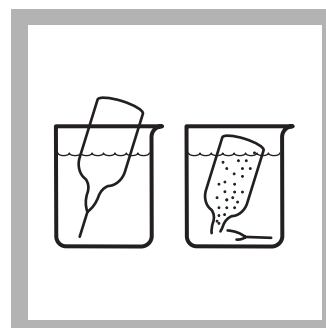

4. Prepared Sample:

Fill a PhosVer 3 Phosphate AccuVac Ampul with sample. Keep the tip immersed while the Ampul fills completely.

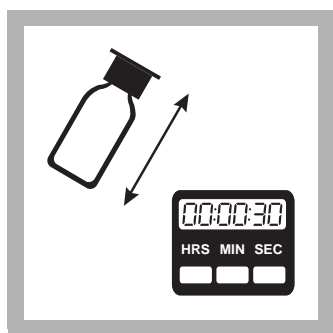

5. Secure an Ampul cap over the tip of the Ampul. Shake the Ampul for approximately 30 seconds. Accuracy is unaffected by undissolved powder.

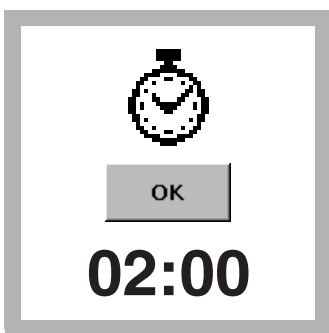

6. Press **TIMER>OK**. A two-minute reaction period will begin. If the sample was digested using the Acid Persulfate digestion, a ten-minute reaction period is required.

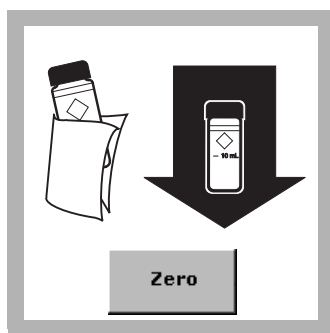

7. When the timer expires, wipe the blank and insert it into the cell holder. Press **ZERO**. The display will show:
0.00 mg/L PO₄³⁻



8. Wipe the prepared sample and insert it into the cell holder. Press **READ**. Results are in mg/L PO₄³⁻.

Interference

Table 1 Interfering Substances and Levels

Interfering Substance	Interference Levels and Treatments
Aluminum	Greater than 200 mg/L
Arsenate	Interferes at any level.
Chromium	Greater than 100 mg/L
Copper	Greater than 10 mg/L
Hydrogen Sulfide	Interferes at any level
Iron	Greater than 100 mg/L
Nickel	Greater than 300 mg/L
pH, excess buffering	Highly buffered samples or extreme sample pH may exceed the buffering capacity of the reagents and require sample pretreatment. pH 2–10 is recommended.
Silica	Greater than 50 mg/L
Silicate	Greater than 10 mg/L
Turbidity (large amounts) or color	May cause inconsistent results because the acid in the powder pillow may dissolve some of the suspended particles and because of variable desorption of orthophosphate from the particles. For highly turbid or colored samples, add the contents of one Phosphate Pretreatment ¹ Powder Pillow to 25 mL of sample. Mix well. Use this solution to zero the instrument.
Zinc	Greater than 80 mg/L

¹ See [Optional Reagents and Apparatus](#) on page 6.

Sample Collection, Storage, and Preservation

Collect sample in plastic or glass bottles that have been cleaned with 1:1 Hydrochloric Acid Solution* and rinsed with deionized water. Do not use commercial detergents containing phosphate for cleaning glassware used in phosphate analysis.

Analyze samples immediately for best results. If prompt analysis is not possible, preserve samples by filtering immediately and storing at 4 °C (39 °F) for up to 48 hours. The sample should be at room temperature before analysis.

Accuracy Check

Standard Additions Method (Sample Spike)

1. After reading test results, leave the sample cell (unspiked sample) in the instrument. Verify the chemical form.
2. Press **OPTIONS>MORE**. Press **STANDARD ADDITIONS**. A summary of the standard additions procedure will appear.
3. Press **OK** to accept the default values for standard concentration, sample volume, and spike volumes. Press **EDIT** to change these values. After values are accepted, the unspiked sample reading will appear in the top row. See the user manual for more information.
4. Open a Phosphate 10-mL Ampule Standard, 50-mg/L PO₄³⁻.
5. Prepare a 0.1-mL sample spike by adding 0.1 mL of standard to the unspiked sample. Press the timer icon. After the timer expires, read the result.
6. Prepare a 0.2-mL sample spike by adding 0.1 mL of standard to the 0.1-mL sample spike. Press the timer icon. After the timer expires, read the result.
7. Prepare a 0.3-mL sample spike by adding 0.1 mL of standard to the 0.2-mL sample spike. Press the timer icon. After the timer expires, read the result. Each addition should reflect approximately 100% recovery.

Note: For AccuVac® Ampuls, fill three Mixing Cylinders† with 50 mL of sample and spike with 0.2 mL, 0.4 mL, and 0.6 mL of standard. Transfer 40 mL from each of the three mixing cylinders to three 50-mL beakers*. Analyze each standard addition sample as described in the procedure above. Accept each standard additions reading by pressing **READ**. Each addition should reflect approximately 100% recovery.

8. After completing the sequence, press **GRAPH** to view the best-fit line through the standard additions data points, accounting for matrix interferences. Press **IDEAL LINE** to view relationships between the sample spikes and the "Ideal Line" of 100% recovery.

* See [Optional Reagents and Apparatus on page 6](#).

† See [Optional Reagents and Apparatus on page 6](#).

Standard Solution Method

1. Prepare a 2.00 mg/L phosphate standard by pipetting 4.00 mL of 50 mg/L Phosphate Standard Solution into a 100 mL volumetric flask. Dilute to volume with demineralized water and mix. Use this solution in place of the sample, and perform the test as described above.

(Alternately, use one of the mixed parameter standards listed in [Recommended Standards on page 6](#). These contain 2.0 mg/L phosphate.)

2. To adjust the calibration curve using the reading obtained with the standard solution, press **OPTIONS>MORE** on the current program menu. Press **STANDARD ADJUST**.
3. Press **ON**. Press **ADJUST** to accept the displayed concentration. If an alternate concentration is used, press the number in the box to enter the actual concentration, then press **OK**. Press **ADJUST**.

Summary of Method

Orthophosphate reacts with molybdate in an acid medium to produce a mixed phosphate/molybdate complex. Ascorbic acid then reduces the complex, giving an intense molybdenum blue color. Test results are measured at 880 nm.

Phosphorus, Reactive (Orthophosphate) (0.02 to 2.50 mg/L PO₄³⁻)

Consumables and Replacement Items

Required Reagents

Description	Quantity/Test	Unit	Cat. No.
PhosVer® 3 Phosphate Reagent Powder Pillows, 10-mL	1	100/pkg	21060-69
OR			
PhosVer® 3 Phosphate Reagent AccuVac® Ampuls	1	25/pkg	25080-25

Required Apparatus (Powder Pillows)

Description	Quantity/Test	Unit	Cat. No.
Sample Cells, 1-inch square, 10 mL, matched pair	2	2/pkg	24954-02
Stopper for 18 mm Tube	1	6/pkg	1731-06

Required Apparatus (AccuVac)

Description	Quantity/Test	Unit	Cat. No.
Adapter, 1-inch round, for AccuVac Ampuls	1	each	LZV584
Beaker, 50-mL	1	each	500-41H
Sample Cell, 10-mL, with cap	1	each	21228-00

Recommended Standards

Description	Unit	Cat. No.
Phosphate Standard Solution, 10-mL Voluette® Ampul, 50-mg/L as PO ₄	16/pkg	171-10
Phosphate Standard Solution, 50-mg/L as PO ₄	500 mL	171-49
Phosphate Standard Solution, 1-mg/L as PO ₄	500 mL	2569-49
Standard, Drinking Water, Mixed Parameter, Inorganic: F-, NO ₃ , PO ₄ , SO ₄	500 mL	28330-49
Wastewater Effluent Standard, for mixed parameters: NH ₃ -N, NO ₃ -N, PO ₄ , COD, SO ₄ , TOC	500 mL/L	28332-49
Water, deionized	4 L	272-56

Optional Reagents and Apparatus

Description	Unit	Cat. No.
Beaker, 50-mL	—	500-41H
Hydrochloric Acid Solution 1:1 500 mL	—	884-49
Mixing Cylinder 50 mL	—	1896-41
Phosphate Treatment Powder Pillow	—	14501-99
Stopper for 18 mm Tube	25/pkg	1731-06



FOR TECHNICAL ASSISTANCE, PRICE INFORMATION AND ORDERING:
In the U.S.A. – Call toll-free 800-227-4224
Outside the U.S.A. – Contact the HACH office or distributor serving you.
On the Worldwide Web – www.hach.com; E-mail – techhelp@hach.com

HACH COMPANY
WORLD HEADQUARTERS
Telephone: (970) 669-3050
FAX: (970) 669-2932

Phosphorus, Reactive (Orthophosphate)

★ Method 8048

PhosVer® 3 Method

Test 'N Tube™ Vials

(0.06 to 5.00 mg/L PO₄³⁻
or 0.02 to 1.60 mg/L P)

Scope and Application: For water, wastewater, and seawater; USEPA accepted for reporting wastewater analysis¹

¹ Procedure is equivalent to USEPA Method 365.2 and Standard Method 4500-P E for wastewater.



Tips and Techniques

Before starting the test:

Important Note: Install the light shield in Cell Compartment #2 before performing this test.

For more accurate results, determine a reagent blank value for each new lot of reagent. Follow the procedure using deionized water instead of the sample. Subtract the reagent blank value from the final results or perform a reagent blank adjust.

Collect the following items:

Quantity

PhosVer® 3 Reagent Powder Pillow	1
Reactive Phosphorus Test 'N Tube Vial	1
Light Shield	1
Micro funnel	1
Pipet, TenSette®, 1–10 mL	1
Pipet Tips for TenSette Pipet	1
Test Tube Rack	varies

Note: Reorder information for consumables and replacement items is on page 4.

Test 'N Tube

Method 8048

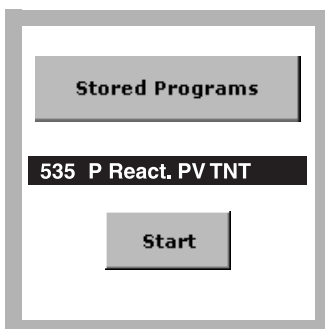

1. Select the test.

Install the Light Shield in Cell Compartment #2.

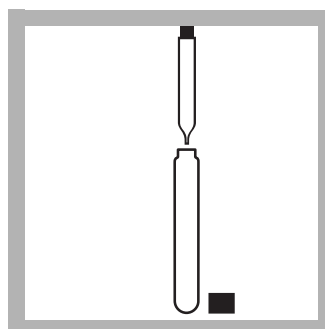

2. Use a TenSette® Pipet to add 5.0 mL of sample to a Reactive Phosphorus Test 'N Tube Dilution Vial. Cap and mix.

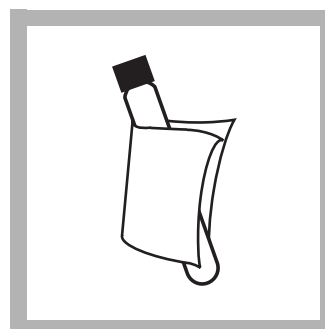

3. Wipe the outside of the vial with a damp towel, followed by a dry one, to remove fingerprints or other marks.

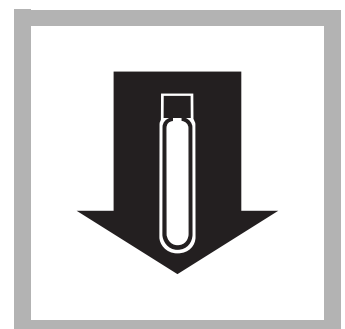

4. Insert the vial into the 16-mm round cell holder.

Phosphorus, Reactive (Orthophosphate) (0.06 to 5.00 mg/L PO₄³⁻ or 0.02 to 1.60 mg/L P)

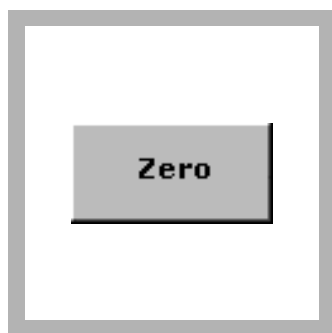

5. Press Zero.

The display will show:
0.00 mg/L PO₄³⁻

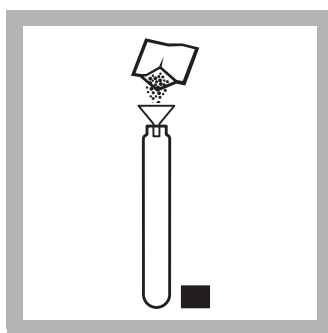

6. Using a funnel, add the contents of one PhosVer 3 Phosphate Powder Pillow to the vial.

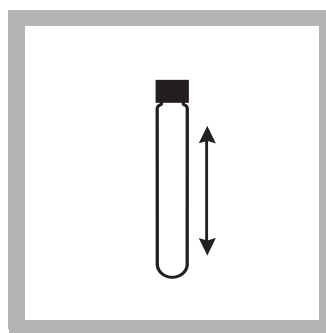

7. Immediately cap the vial tightly and shake for at least 20 seconds. The powder will not dissolve completely.

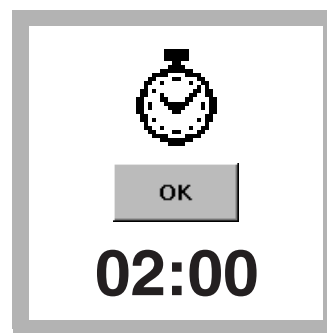

8. Press TIMER>OK.

A two-minute reaction period will begin. Read samples between two and eight minutes after adding the PhosVer 3 reagent.



9. Wipe the outside of the vial with a damp towel, followed by a dry one, to remove fingerprints or other marks.



10. When the timer expires, insert the vial into the 16 mm round cell holder.



11. Press READ.
Results are in mg/L PO₄³⁻.

Interferences

Table 1 Interfering Substances and Levels

Interfering Substance	Interference Levels and Treatments
Aluminum	Greater than 200 mg/L
Arsenate	All levels
Chromium	Greater than 100 mg/L
Copper	Greater than 10 mg/L
Iron	Greater than 100 mg/L
Nickel	Greater than 300 mg/L
Silica	Greater than 50 mg/L
Silicate	Greater than 10 mg/L
Sulfide	Greater than 6 mg/L. Remove sulfide interference as follows: <ol style="list-style-type: none"> 1. Measure 25 mL of sample into a 50-mL beaker. 2. Swirling constantly, add Bromine Water drop-wise until a permanent yellow color appears. 3. Swirling constantly, add Phenol Solution drop-wise just until the yellow color disappears. Proceed with <i>step 1</i> of the phosphorus procedure.

Table 1 Interfering Substances and Levels (continued)

Interfering Substance	Interference Levels and Treatments (continued)
Turbidity	Large amounts may cause inconsistent results in the test because the acid present in the powder pillows may dissolve some of the suspended particles and because of variable desorption of orthophosphate from the particles.
Zinc	Greater than 80 mg/L
Highly buffered samples or extreme sample pH	May exceed the buffering capacity of the reagents and require sample pretreatment.

Sample Collection, Storage, and Preservation

Collect samples in plastic or glass bottles that have been acid cleaned with 1:1 Hydrochloric Acid Solution* and rinsed with deionized water. Do not use commercial detergents containing phosphate for cleaning glassware used in this test.

Analyze samples immediately after collection for best results. If prompt analysis is impossible, preserve samples up to 48 hours by filtering immediately and storing at 4 °C. Warm samples to room temperature before analysis.

Accuracy Check

Standard Additions Method (Sample Spike)

1. Clean glassware with 1:1 Hydrochloric Acid Solution. Rinse again with deionized water. Do not use phosphate detergents to clean glassware.
2. After reading test results, leave the sample cell (unspiked sample) in the instrument. Verify the chemical form.
3. Press **OPTIONS>MORE**. Press **STANDARD ADDITIONS**. A summary of the standard additions procedure will appear.
4. Press **OK** to accept the default values for standard concentration, sample volume, and spike volumes. Press **EDIT** to change these values. After values are accepted, the unspiked sample reading will appear in the top row. See the user manual for more information.
5. Snap the neck off a Phosphate 2-mL Ampule Standard, 50-mg/L as PO₄³⁻.
6. Prepare three sample spikes. Use the TenSette® Pipet to add 0.1 mL, 0.2 mL, and 0.3 mL of standard, respectively to three 25-mL samples and mix each thoroughly.
7. Analyze each sample spike as described in the procedure above, starting with the 0.1 mL sample spike. Accept each standard additions reading by pressing **READ**. Each addition should reflect approximately 100% recovery.
8. After completing the sequence, press **GRAPH** to view the best-fit line through the standard additions data points, accounting for matrix interferences. Press **IDEAL LINE** to view relationships between the sample spikes and the “Ideal Line” of 100% recovery.

Standard Solution Method

1. Use a 3.0-mg/L phosphate standard solution instead of the sample. Perform the procedure as describe above.
2. To adjust the calibration curve using the reading obtained with the standard solution, press **OPTIONS>MORE** on the current program menu. Press **STANDARD ADJUST**.

* See [Optional Reagents and Apparatus on page 4](#).

Phosphorus, Reactive (Orthophosphate) (0.06 to 5.00 mg/L PO₄³⁻ or 0.02 to 1.60 mg/L P)

- Press **ON**. Press **ADJUST** to accept the displayed concentration. If an alternate concentration is used, press the number in the box to enter the actual concentration, then press **OK**. Press **ADJUST**.

Summary of Method

Orthophosphate reacts with molybdate in an acid medium to produce a mixed phosphate/molybdate complex. Ascorbic acid then reduces the complex, giving an intense molybdenum blue color. Test results are measured at 880 nm.

Consumables and Replacement Items

Required Reagents

Description	Quantity/Test	Unit	Cat. No.
Reactive Phosphorus Test 'N Tube™ Reagent Set (50 tests), includes:	—	—	27425-45
PhosVer® 3 Phosphate Reagent Powder Pillows	1	50/pkg	21060-46
Reactive Phosphorus Test 'N Tube Dilution Vials	1	50/pkg	NA ¹

¹ Not available separately

Required Apparatus

Description	Quantity/Test	Unit	Cat. No.
Funnel, micro	1	each	25843-35
Light Shield	1	each	LZV646
Pipet, TenSette®, 1 to 10 mL	1	each	19700-10
Pipet Tips, for TenSette Pipet 19700-10	1	50/pkg	21997-96
Test Tube Rack	1-3	each	18641-00

Recommended Standards

Description	Unit	Cat. No.
Phosphate Standard Solution, Voluette™ Ampule, 50-mg/L as PO ₄ ³⁻ , 2-mL	20/pkg	17120-H
Phosphate Standard Solution, 50-mg/L	500 mL	171-49
Phosphate Standard Solution, 1-mg/L as PO ₄ ³⁻	500 mL	2569-49
Phosphate Standard Solution, 3 mg/L as PO ₄ ³⁻	946 mL	20597-16
Standard, Drinking Water, Mixed Parameter, Inorganic for F ⁻ , NO ₃ , PO ₄ , SO ₄	500 mL	28330-49
Wastewater Effluent Standard, for mixed parameters: NH ₃ -N, NO ₃ -N, PO ₄ , COD, SO ₄ , TOC	500 mL	28332-49

Optional Reagents and Apparatus

Description	Unit	Cat. No.
Bromine Water 30 g/L	25 mL	2211-20
Hydrochloric Acid Solution 1:1	500 mL	884-49
Phenol Solution 30 g/L	29 mL	2112-20



FOR TECHNICAL ASSISTANCE, PRICE INFORMATION AND ORDERING:
In the U.S.A. – Call toll-free 800-227-4224
Outside the U.S.A. – Contact the HACH office or distributor serving you.
On the Worldwide Web – www.hach.com; E-mail – techhelp@hach.com

HACH COMPANY
WORLD HEADQUARTERS
Telephone: (970) 669-3050
FAX: (970) 669-2932

Phosphorus, Reactive (Orthophosphate) and Total

Method 10209 Reactive; Method 10210 Total

Ascorbic Acid Method

TNTplus 843

LR (0.15–4.50 mg/L PO₄³⁻ or 0.05–1.50 mg/L PO₄-P)

Scope and Application: For wastewater, drinking water, boiler water, surface water, and process water



Test Preparation

Before starting the test:

Important Note: Install the light shield in Cell Compartment #2 before performing this test.

Please read Safety Advice and Expiration Date on package.

Recommended sample and reagent temperature is 15–25 °C (59–77 °F). Recommended reagent storage temperature is 15–25 °C (59–77 °F).

Recommended sample pH is between 2–10.

The final samples will contain molybdenum. In addition, the final samples will have a pH less than 2 and are considered corrosive (D002) by the Federal RCRA. Refer to the current MSDS for safe handling and disposal instructions.

TNT plus methods are activated from the Main Menu screen when the sample vial is inserted into the sample cell holder.

Collect the following items:

Quantity

Phosphorus, Reactive and Total LR TNT843 Reagent Set	1
DRB Reactor for use with 13 mm wells (use adapters with 16 mm holes)	1
Light Shield	1
Pipettor for 100–1000 µL Sample	1
Pipettor Tips for 100–1000 µL Pipettor	1
Pipettor for 5.0 mL Sample	1
Pipettor Tip	varies
Test Tube Tack	1

Note: Reorder information for consumables and replacement items is on page 6.

TNTplus—Phosphorus, Total

Method 10210

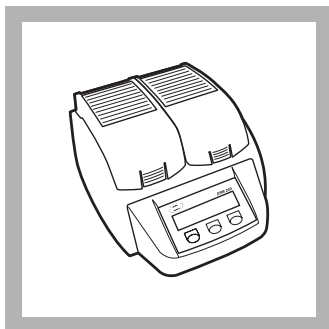

1. Turn on the DRB200 Reactor. Heat to 100 °C.

Note: For DRB200 Reactors with 16-mm wells, insert a 16-mm to 13-mm adapter sleeve into each well before turning on the reactor.

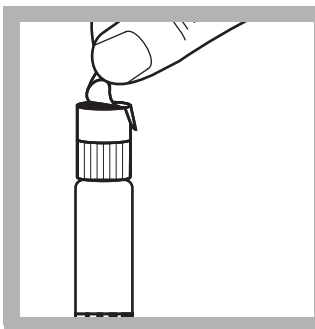

2. Carefully remove the protective foil lid from the DosiCap™ Zip. Unscrew the cap from the vial.

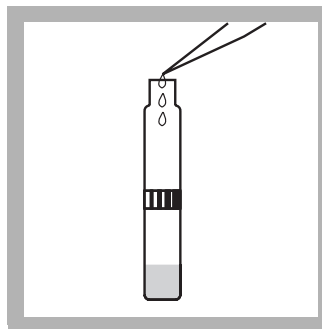

3. Carefully pipet 2.0 mL of sample into the vial.

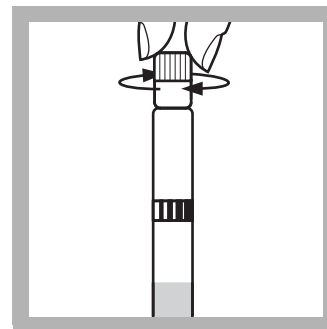

4. Flip the DosiCap Zip over so the reagent side faces the vial. Screw the cap tightly onto the vial.

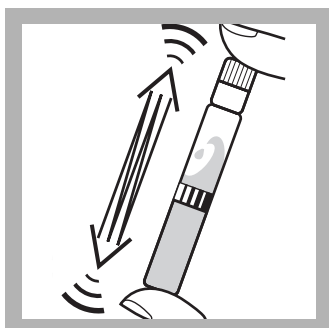

5. Shake the capped vial with 2–3 times to dissolve the reagent in the cap.

Verify that the reagent has dissolved by looking down through the open end of the DosiCap Zip.

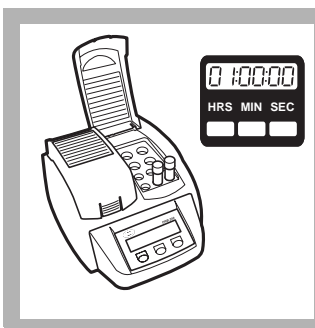

6. Insert the vial in the DRB200 Reactor. Close the protective cover. Heat for 1 hour at 100 °C.

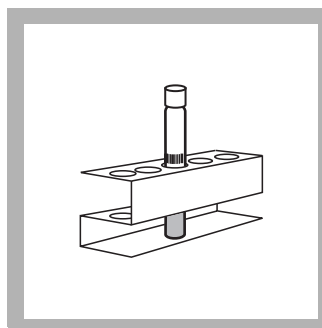

7. After the timer expires, carefully remove the hot vial from the reactor. Insert them in a test tube rack and allow to cool to room temperature (15–25 °C).

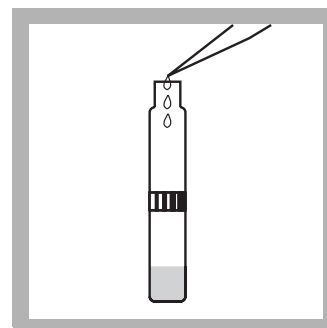

8. Pipet 0.2 mL (200 µL) of Reagent B into the cooled vial.

Immediately close the Reagent B container.

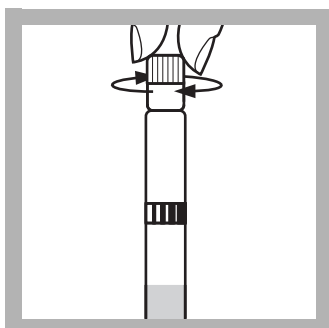

9. Screw a grey DosiCap C onto the vial.

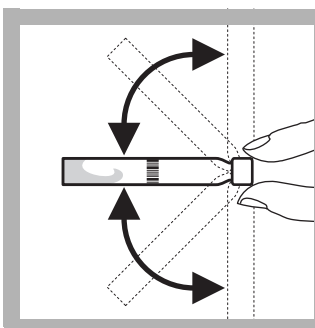

10. Invert the capped vial 2–3 times to dissolve the reagent in the DosiCap.



11. Wait 10 minutes. Install the Light Shield in Cell Compartment #2.

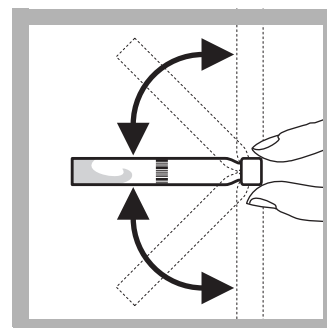

12. When the timer expires, invert the vial again 2–3 times.

Phosphorus, Reactive (Orthophosphate) and Total LR (0.15–4.50 mg/L PO₄³⁻ or 0.05–1.50 mg/L PO₄-P)

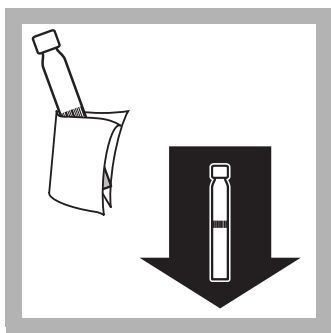

13. Clean the outside of the vial and insert it into the cell holder. The instrument reads the barcode, then selects and performs the correct test.

Results are in mg/L PO₄.

No instrument Zero is required.

TNTplus—Phosphorus, Reactive (Orthophosphate)

Method 10209

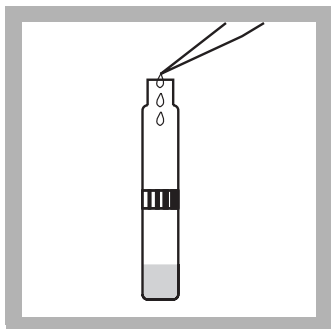

1. Carefully pipet 2.0 mL of sample into the vial.

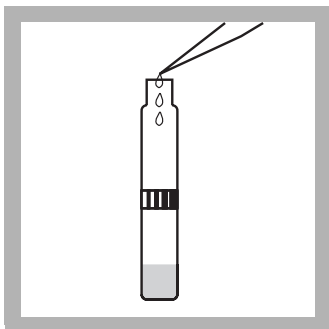

2. Pipet 0.2 mL (200 µL) of Reagent B into the vial.
Note: Immediately close the Reagent B container.

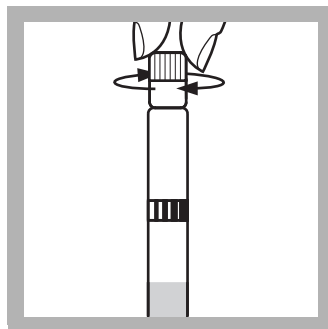

3. Screw a grey DosiCap C onto the vial.

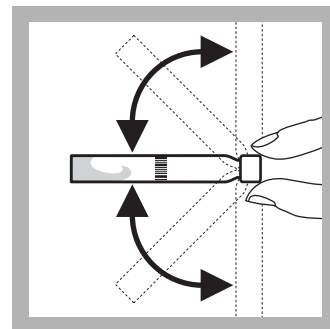

4. Invert the capped vial 2–3 times to dissolve the reagent in the DosiCap.

Phosphorus, Reactive (Orthophosphate) and Total LR (0.15–4.50 mg/L PO₄³⁻ or 0.05–1.50 mg/L PO₄-P)



5. Wait 10 minutes.
Install the Light Shield in Cell Compartment #2.

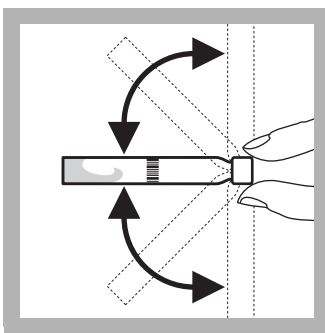

6. When the timer expires, invert the vial again 2–3 times.

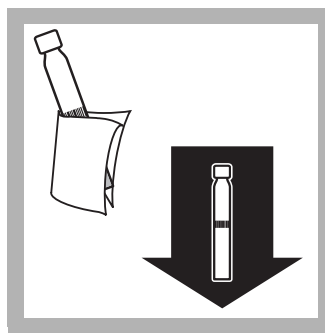

7. Clean the outside of the vial and insert it into the cell holder. The instrument reads the barcode, then selects and performs the correct test.

Results are in mg/L PO₄.

No instrument Zero is required.

Reagent Blanks

A reagent blank can be measured, and the value subtracted from the results of each test performed using the same reagent lot number. Use deionized water in place of sample and run the procedure as described.

To subtract the value of the blank from a series of measurements, measure the blank per step 13 of the total phosphorus procedure or step 7 of the reactive phosphorus procedure. Press **OPTIONS>MORE>REAGENT BLANK**. Press **ON**. The measured value of the blank should be displayed in the highlighted box. Press **OK** to accept this value. The reagent blank value will now be subtracted from all results until the function is turned off, or a different method is selected. Alternately, the blank can be recorded and entered at any later time by pressing the highlighted box and using the keypad to enter the value.

Sample Blanks

Color or turbidity in samples can cause high results. The digestion in the total phosphate procedure usually destroys all color and turbidity and a sample blank is not required.

To compensate for color or turbidity in the reactive phosphate procedure the color forming reagent that is present in the DosiCap C is not added.

To determine the sample blank run the reactive procedure as given, but do not add the DosiCap C in step 3. Cap the vial with the original DosiCap **Zip** (do not remove the foil). Use the side of the cap without the reagent. The value obtained in step 7 is then subtracted from the value obtained on the original reactive phosphate sample to give the corrected sample concentration.

Alternatively, reactive phosphate samples that contain only turbidity may be first filtered through a membrane filter and then analyzed. Samples without color or turbidity do not require sample blanks.

Interferences

The ions listed in [Table 1](#) have been individually checked up to the given concentrations and do not cause interference. Cumulative effects and the influence of other ions have not been determined. Measurement results can be verified using sample dilutions or standard additions.

Phosphorus, Reactive (Orthophosphate) and Total LR (0.15–4.50 mg/L PO₄³⁻ or 0.05–1.50 mg/L PO₄-P)

Table 1 Interfering Substances and Levels

Interfering Substance	Interference Level
SO ₄ ²⁻	5000 mg/L
Cl ⁻	2000 mg/L
K ⁺ , Na ⁺	1000 mg/L
NO ₃ ⁻	500 mg/L
Ca ²⁺	250 mg/L
Mg ²⁺	100 mg/L
CO ₃ ²⁻ , Fe ²⁺ , Fe ³⁺ , Zn ²⁺ , Cu ²⁺ , Ni ²⁺ , I ⁻ , NO ₂ ⁻ , Cd ²⁺ , NH ₄ ⁺ , Mn ²⁺ , Al ³⁺ , CO ₃ ²⁻ , SiO ₂	50 mg/L
Sn ⁴⁺ , Hg ²⁺	5 mg/L
Ag ⁺ , Pb ²⁺	2.5 mg/L
Cr ³⁺	1 mg/L
Cr ⁸⁺	0.5 mg/L

Sampling and Storage

Collect samples in plastic or glass bottles that have been acid cleaned with 1:1 Hydrochloric Acid Solution* and rinsed with deionized water. Do not use commercial detergents containing phosphate for cleaning glassware used in this test.

Analyze samples immediately after collection for best results. If prompt analysis is impossible, preserve samples for total phosphorus up to 28 days by adjusting the pH to 2 or less with concentrated Sulfuric Acid* (about 2 mL per liter) and storing at 4 °C. Samples to be analyzed for reactive phosphorus should not be preserved with acid. These samples should be stored at 4 °C and analyzed within 48 hours. Warm samples to 15–25 °C and neutralize with 5.0 N Sodium Hydroxide* before analysis if acid has been added. Correct for volume additions.

Accuracy Check

Standard Solution Method

1. Check the accuracy of the reactive and total phosphorus methods with a 3 mg/L phosphate standard solution. Use 2.0 mL this 3 mg/L standard in place of the sample in step 3 of the total phosphorus procedure or step 2 of the reactive phosphorus procedure.
2. Alternately, use 2.0 mL of a Wastewater Effluent Mixed Parameters Inorganics Standard in place of the sample in step 2. This standard contains 2 mg/L phosphate in the presence of several other ions such as nitrate, sulfate and ammonia.

Summary of Method

Phosphates present in organic and condensed inorganic forms (meta-, pyro-, or other polyphosphates) are first converted to reactive orthophosphate in the total phosphorus procedure. Treatment of the sample with acid and heat provides the conditions for hydrolysis of the condensed inorganic forms. Organic phosphates are also converted to orthophosphates in the total phosphorus procedure by heating with acid and persulfate. The reactive phosphorus procedure measures only the reactive (ortho) phosphorus present in the sample.

The reactive or orthophosphate ions react with molybdate and antimony ions in an acidic solution to form an antimonyl phosphomolybdate complex, which is reduced by ascorbic acid to phosphomolybdenum blue. Test results are measured at 890 nm.

* See [Optional Reagents and Apparatus on page 6](#).

Phosphorus, Reactive (Orthophosphate) and Total LR (0.15–4.50 mg/L PO₄³⁻ or 0.05–1.50 mg/L PO₄-P)

Consumables and Replacement Items

Required Reagents

Description	Quantity/Test	Unit	Cat. No.
Phosphorus, Reactive and Total, LR TNT843 Reagent Set	1	25/pkg	TNT843

Required Apparatus

Description	Quantity/Test	Unit	Cat. No.
DRB200 Reactor, 115 V, 9x13mm + 2x20 mm (mono block)	1	each	DRB200-01
OR			
DRB200 Reactor, 230 V, 9x13mm + 2x20 mm (mono block)	1	each	DRB200-05
Light Shield	1	each	LZV646
Pipettor, variable volume, 100–1000 µL	1	each	27949-00
Pipettor Tips, for 27949-00 pipettor	1	400/pkg	27950-00
Pipettor, variable volume, 1–5 mL	1	each	27951-00
Pipettor Tips, for 27951-00 pipettor	1	400/pkg	27952-00
Test Tube Rack	1–3	each	18641-00

Recommended Standards and Apparatus

Description	Unit	Cat. No.
Phosphate Standard Solution, 3-mg/L as PO ₄ ³⁻	946 mL	20597-16
Wastewater Effluent Inorganics Standard for NH ₃ -N, NO ₃ -N, PO ₄ , COD, SO ₄ , TOC	500 mL	28332-49

Optional Reagents and Apparatus

Description	Unit	Cat. No.
TNTplus Reactor adapter sleeves, 16-mm to 13-mm diameter	5/pkg	28958-05
Bottle, sampling, low density poly, w/cap, 500 mL	12/pkg	20870-79
DRB200 Reactor, 115 V, 21x13 mm + 4x20 mm (dual block)	each	DRB200-02
DRB200 Reactor, 115 V, 15x13 mm + 15x13 mm (dual block)	each	DRB200-03
DRB200 Reactor, 115 V, 12x13 mm + 8x20 mm (dual block)	each	DRB200-04
DRB200 Reactor, 230 V, 21x13mm + 4x20 mm (dual block)	each	DRB200-06
DRB200 Reactor, 230 V, 15x13mm + 15x13 mm (dual block)	each	DRB200-07
DRB200 Reactor, 230 V, 12x13mm + 8x20 mm (dual block)	each	DRB200-08
Filter Holder, glass for vacuum filtration (SUVA)	each	2340-00
Filter, membrane, 47-mm, 0.45-micron, hydrophilic, polyethersulfone for SUVA	each	28947-00
Flask, filtering, glass, 1000-mL (SUVA)	each	546-53
Hydrochloric Acid 6N (1:1)	500 mL	884-49
Sodium Hydroxide, 5.0 N, 1000 mL	1000 mL	2450-53
Sulfuric Acid, concentrated, 500 mL	500 mL	979-49
Tubing, rubber	12 ft	560-19



FOR TECHNICAL ASSISTANCE, PRICE INFORMATION AND ORDERING:
In the U.S.A. – Call toll-free 800-227-4224
Outside the U.S.A. – Contact the HACH office or distributor serving you.
On the Worldwide Web – www.hach.com; E-mail – techhelp@hach.com

HACH COMPANY
WORLD HEADQUARTERS
Telephone: (970) 669-3050
FAX: (970) 669-2932

Phosphorus, Reactive (Orthophosphate) and Total

Method 10209 Reactive; Method 10210 Total

Ascorbic Acid Method

TNTplus™ 844

HR (1.5 to 15.0 mg/L PO₄³⁻ or 0.5 to 5.0 mg/L PO₄-P)

Scope and Application: For wastewater, drinking water, boiler water, surface water, and process analysis



Test Preparation

Before starting the test:

Important Note: Install the light shield in Cell Compartment #2 before performing this test.

Please read Safety Advice and Expiration Date on package.

Recommended sample and reagent temperature is 15–25 °C (59–77 °F). Recommended reagent storage temperature is 15–25 °C (59–77 °F).

Recommended sample pH is between 2–10.

The final samples will contain molybdenum. In addition, the final samples will have a pH less than 2 and are considered corrosive (D002) by the Federal RCRA. Refer to the current MSDS for safe handling and disposal instructions.

TNT plus methods are activated from the Main Menu screen when the sample vial is inserted into the sample cell holder.

Collect the following items:

Quantity

Phosphorus, Reactive Total HR TNT844 Reagent Set	1
DRB Reactor for use with 13-mm wells (use adapters with 16-mm holes)	1
Light Shield	1
Pipettor for 100–1000 µL Sample	1
Pipettor Tips for 100–1000 µL Pipettor	1
Test Tube Rack	2

Note: Reorder information for consumables and replacement items is on page 7.

TNTplus—Phosphorus, Total

Method 10210

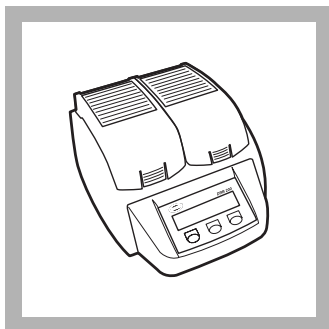

1. Turn on the DRB200 Reactor Heat to 100 °C.

Note: For DRB200 Reactors with 16-mm wells, insert a 16-mm to 13-mm adapter sleeve into each well before turning on the reactor.

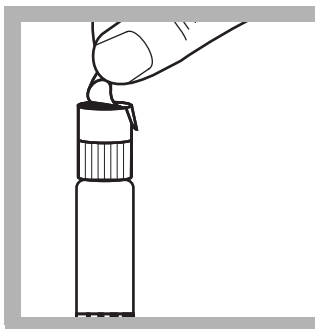

2. Carefully remove the protective foil lid from the DosiCap™ Zip. Unscrew the cap from the vial.

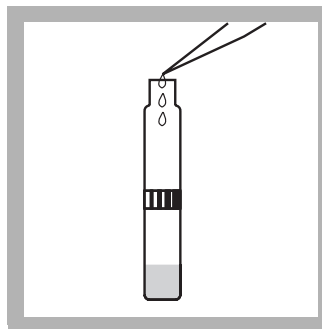

3. Carefully pipet 0.5 mL (500 µL) of sample into the vial.

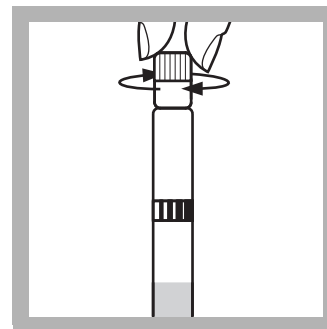

4. Flip the DosiCap Zip over so the reagent side faces the vial. Screw the cap tightly onto the vial.

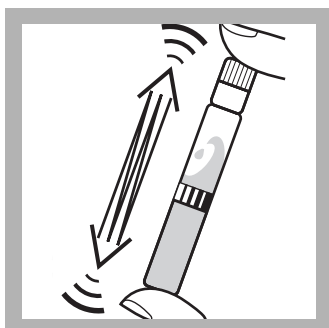

5. Shake the vial 2–3 times to dissolve the reagent in the cap.

Verify that the reagent has dissolved by looking down through the open end of the DosiCap Zip.

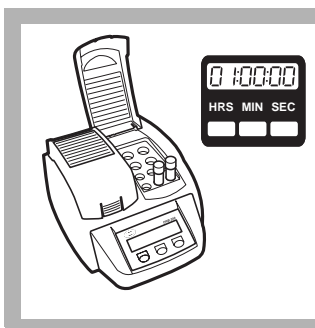

6. Insert the vial in the DRB200 Reactor. Close the protective cover. Heat for 1 hour at 100 °C.

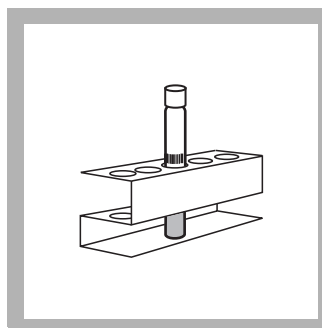

7. After the timer expires, carefully remove the hot vial from the reactor. Insert them in a test tube rack and allow to cool to room temperature (15–25 °C).

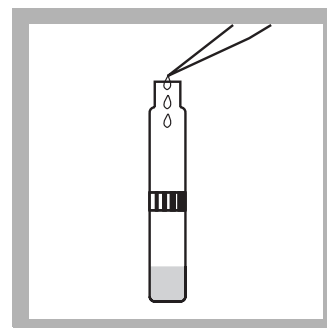

8. Pipet 0.2 mL (200 µL) of Reagent B into the cooled vial. Immediately close the Reagent B container.

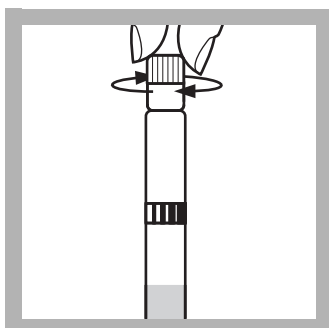

9. Screw a gray DosiCap C onto the vial.

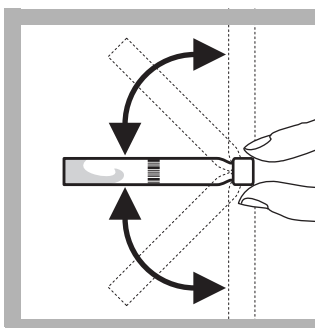

10. Invert the vial 2–3 times to dissolve the reagent in the DosiCap.



11. Wait 10 minutes. Install the Light Shield in Cell Compartment #2.

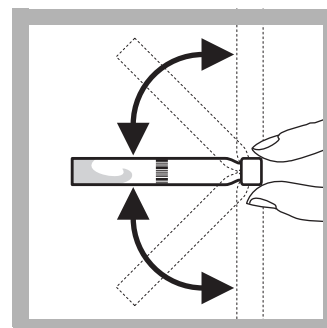

12. When the timer expires, invert the vial again 2–3 times.

Phosphorus, Reactive (Orthophosphate) and Total HR (1.5 to 15.0 mg/L PO₄³⁻ or 0.5 to 5.0 mg/L PO₄-P)



13. Clean the outside of the vial and insert it into the cell holder. The instrument reads the barcode, then selects and performs the correct test.

Results are in mg/L PO₄.

No instrument Zero is required.

TNTplus—Phosphorus, Reactive (Orthophosphate)

Method 10209

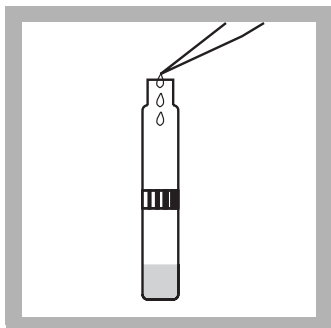

1. Carefully pipet 0.5 mL (500 µL) of sample into the vial.

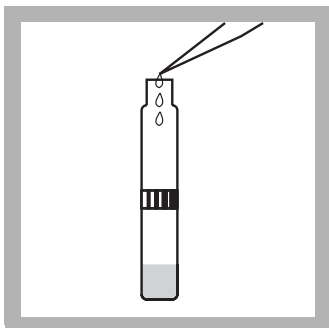

2. Pipet 0.2 mL (200 µL) of Reagent B into the vial. Immediately close the Reagent B container.

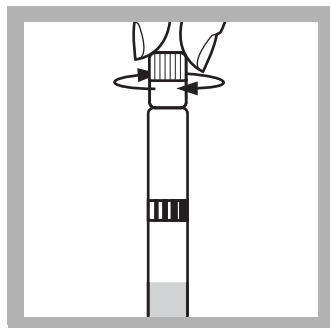

3. Screw a grey DosiCap C onto the vial.

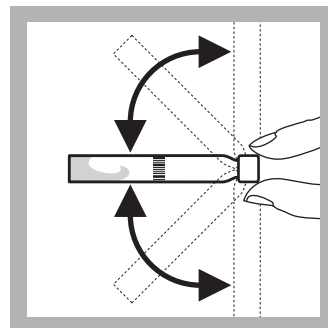

4. Invert the capped vial 2–3 times to dissolve the reagent in the DosiCap.

Phosphorus, Reactive (Orthophosphate) and Total HR (1.5 to 15.0 mg/L PO₄³⁻ or 0.5 to 5.0 mg/L PO₄-P)



5. Wait 10 minutes.
Install the Light Shield in Cell Compartment #2.

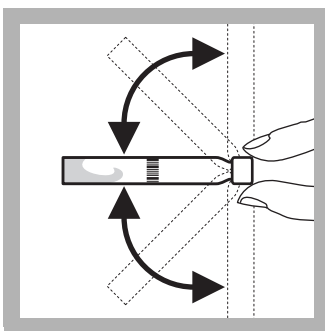

6. When the timer expires, invert the vial again 2–3 times.

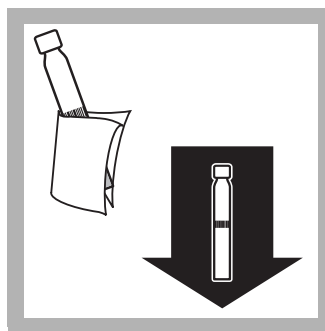

7. Clean the outside of the vial and insert it into the cell holder. The instrument reads the barcode, then selects and performs the correct test.

Results are in mg/L PO₄.

No instrument Zero is required.

Reagent Blanks

A reagent blank can be measured, and the value subtracted from the results of each test performed using the same reagent lot number. Use deionized water in place of sample and run the procedure as described.

To subtract the value of the blank from a series of measurements, measure the blank per step 13 of the total phosphorus procedure or step 7 of the reactive phosphorus procedure. Press **OPTIONS>MORE>REAGENT BLANK**. Press **ON**. The measured value of the blank should be displayed in the highlighted box. Press **OK** to accept this value. The reagent blank value will now be subtracted from all results until the function is turned off, or a different method is selected. Alternately, the blank can be recorded and entered at any later time by pressing the highlighted box and using the keypad to enter the value.

Sample Blanks

Color or turbid samples can cause high results. The digestion in the total phosphate procedure usually destroys all color and turbidity and a sample blank is not required.

To compensate for color or turbidity in the reactive phosphate procedure the color forming reagent that is present in the DosiCap C is not added.

To determine the sample blank run the reactive procedure as given, but do not add the DosiCap C in step 3. Cap the vial with the original DosiCap **Zip** (do not remove the foil). Use the side of the cap without the reagent. The value obtained in step 7 is then subtracted from the value obtained on the original reactive phosphate sample to give the corrected sample concentration.

Alternatively, reactive phosphate samples that contain only turbidity may be first filtered through a membrane filter and then analyzed. Samples without color or turbidity do not require sample blanks.

Phosphorus, Reactive (Orthophosphate) and Total HR (1.5 to 15.0 mg/L PO₄³⁻ or 0.5 to 5.0 mg/L PO₄-P)

Interferences

The ions listed in [Table 1](#) have been individually checked up to the given concentrations and do not cause interference. Cumulative effects and the influence of other ions have not been determined. Measurement results can be verified using sample dilutions or standard additions.

Table 1 Interfering Substances and Levels

Interfering Substance	Interference Level
SO ₄ ²⁻	20 g/L
Cl ⁻	10 g/L
Ca ²⁺	1000 mg/L
K ⁺ , Na ⁺	4000 mg/L
NO ₃ ⁻	500 mg/L
Mg ²⁺	400 mg/L
Co ²⁺ , Fe ²⁺ , Fe ³⁺ , Zn ²⁺ , Cu ²⁺ , Ni ²⁺ , NO ₂ ⁻ , Cd ²⁺ , NH ₄ ⁺ , Mn ²⁺ , Al ³⁺ , CO ₃ ²⁻	200 mg/L
I ⁻	100 mg/L
SiO ₂	50 mg/L
Hg ²⁺	40 mg/L
Pb ²⁺	20 mg/L
Ag ⁺ , Sn ⁴⁺	10 mg/L
Cr ³⁺	5 mg/L
Cr ⁶⁺	1 mg/L

Sampling and Storage

Collect samples in plastic or glass bottles that have been acid cleaned with 1:1 Hydrochloric Acid Solution and rinsed with deionized water. Do not use commercial detergents containing phosphate for cleaning glassware used in this test.

Analyze samples immediately after collection for best results. If prompt analysis is impossible, preserve samples for total phosphorus up to 28 days by adjusting the pH to 2 or less with concentrated Sulfuric Acid (about 2 mL per liter) and storing at 4 °C. Samples to be analyzed for reactive phosphorus should not be preserved with acid. These samples should be stored at 4 °C and analyzed within 48 hours. Warm samples to 15–25 °C and neutralize with 5.0 N Sodium Hydroxide before analysis if acid has been added. Correct for volume additions.

Accuracy Check

Standard Solution Method

1. Check the accuracy of the reactive and total phosphorus methods with a 10 mg/L phosphate standard solution. Use 5.0 mL of this standard in place of the sample in [step 3](#) of the total phosphorus procedure or in [step 2](#) of the reactive phosphorus procedure.
2. Alternately, use 0.5 mL of a Wastewater Effluent Mixed Parameters Inorganics Standard in place of the sample. This standard contains 10 mg/L phosphate in the presence of several other ions such as nitrate, sulfate and ammonia.

Summary of Method

Phosphates present in organic and condensed inorganic forms (meta-, pyro-, or other polyphosphates) are first converted to reactive orthophosphate in the total phosphorus procedure. Treatment of the sample with acid and heat provides the conditions for hydrolysis of the condensed inorganic forms. Organic phosphates are also converted to orthophosphates by heating with acid and persulfate in the total phosphorus procedure. The reactive phosphorus procedure measures only the reactive (ortho) phosphorus present in the sample.

The reactive or orthophosphate ions react with molybdate and antimony ions in an acidic solution to form an antimonyl phosphomolybdate complex, which is reduced by ascorbic acid to phosphomolybdenum blue. Test results are measured at 890 nm.

Phosphorus, Reactive (Orthophosphate) and Total HR (1.5 to 15.0 mg/L PO₄³⁻ or 0.5 to 5.0 mg/L PO₄-P)

Consumables and Replacement Items

Required Reagents

Description	Quantity/Test	Unit	Cat. No.
Phosphorus, Reactive and Total, HR TNT844 Reagent Set	1	25/pkg	TNT844

Required Apparatus

Description	Quantity/Test	Unit	Cat. No.
DRB200 Reactor, 115 V, 9x13mm + 2x20 mm (mono block)	1	each	DRB200-01
OR			
DRB200 Reactor, 230 V, 9x13mm + 2x20 mm (mono block)	1	each	DRB200-05
Light Shield	1	each	LZV646
Pipettor, variable volume, 100–1000 µL	1	each	27949-00
Pipettor Tips, for 27949-00 pipettor	1	400/pkg	27950-00
Test Tube Rack	1–3	each	18641-00

Recommended Standards and Apparatus

Description	Unit	Cat. No.
Phosphate Standard Solution, 10-mg/L as PO ₄	946 mL	14204-16
Wastewater Influent Inorganics Standard for NH ₃ -N, NO ₃ -N, PO ₄ , COD, SO ₄ , TOC	500 mL	28331-49

Optional Reagents and Apparatus

Description	Unit	Cat. No.
TNTplus Reactor adapter sleeves, 16-mm to 13-mm diameter	5/pkg	28958-05
Bottle, sampling, low density poly, w/cap, 500 mL	12/pkg	20870-79
DRB200 Reactor, 115 V, 21x13 mm + 4x20 mm (dual block)	each	DRB200-02
DRB200 Reactor, 115 V, 15x13 mm + 15x13 mm (dual block)	each	DRB200-03
DRB200 Reactor, 115 V, 12x13 mm + 8x20 mm (dual block)	each	DRB200-04
DRB200 Reactor, 230 V, 21x13mm + 4x20 mm (dual block)	each	DRB200-06
DRB200 Reactor, 230 V, 15x13mm + 15x13 mm (dual block)	each	DRB200-07
DRB200 Reactor, 230 V, 12x13mm + 8x20 mm (dual block)	each	DRB200-08
Filter Holder, glass for vacuum filtration (SUVA)	each	2340-00
Filter, membrane, 47-mm, 0.45-micron, hydrophilic, polyethersulfone for SUVA	each	28947-00
Flask, filtering, glass, 1000-mL (SUVA)	each	546-53
Hydrochloric Acid 6N (1:1)	500 mL	884-49
Sodium Hydroxide, 5.0 N, 1000 mL	1000 mL	2450-53
Sulfuric Acid, concentrated, 500 mL	500 mL	979-49
Tubing, rubber	12 ft	560-19



FOR TECHNICAL ASSISTANCE, PRICE INFORMATION AND ORDERING:

In the U.S.A. – Call toll-free 800-227-4224
Outside the U.S.A. – Contact the HACH office or distributor serving you.
On the Worldwide Web – www.hach.com; E-mail – techhelp@hach.com

HACH COMPANY
WORLD HEADQUARTERS
Telephone: (970) 669-3050
FAX: (970) 669-2932

Phosphorus, Reactive (Orthophosphate) and Total

Method 10209 Reactive; Method 10210 Total

Ascorbic Acid Method

TNTplus™ 845

UHR (6 to 60 mg/L PO₄³⁻ or 2 to 20 mg/L PO₄-P)

Scope and Application: For wastewater, drinking water, boiler water, surface water, and process analysis



Test Preparation

Before starting the test:

Important Note: Install the light shield in Cell Compartment #2 before performing this test.

Please read Safety Advice and Expiration Date on package.

Recommended sample and reagent temperature is 15–25 °C (59–77 °F). Recommended reagent storage temperature is 15–25 °C (59–77 °F).

Recommended sample pH is between 2–10.

TNT plus methods are activated from the Main Menu screen when the sample vial is inserted into the sample cell holder.

The final samples will contain molybdenum. In addition, the final samples will have a pH less than 2 and are considered corrosive (D002) by the Federal RCRA. Refer to the current MSDS for safe handling and disposal instructions.

Collect the following items:

Quantity

Phosphorus, Reactive Total HR TNT845 Reagent Set	1
DRB200 Reactor with 13-mm wells (adapter available for DRB Reactors with 16-mm holes)	1
Light Shield	1
Pipettor for 100–1000 µL Sample	1
Pipettor Tips for 100–1000 µL Pipettor	2
Test Tube Rack	1–3

Note: Reorder information for consumables and replacement items is on page 7.

Phosphorus, Reactive (Orthophosphate) and Total UHR (6 to 60 mg/L PO₄³⁻ or 2 to 20 mg/L PO₄-P)

TNTplus—Phosphorus, Total

Method 10210

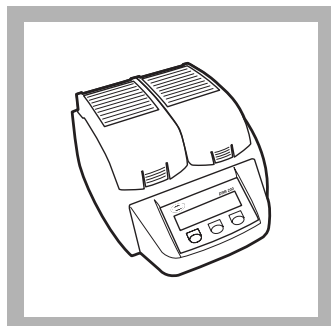

1. Turn on the DRB200 Reactor Heat to 100 °C.

Note: For DRB200 Reactors with 16-mm wells, insert a 16-mm to 13-mm adapter sleeve into each well before turning on the reactor.

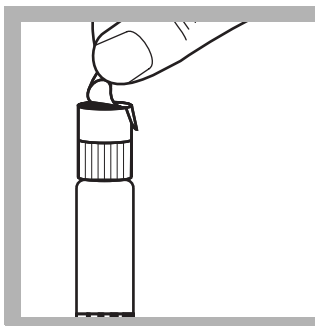

2. Carefully remove the protective foil lid from the DosiCap™ Zip. Unscrew the cap from the vial.

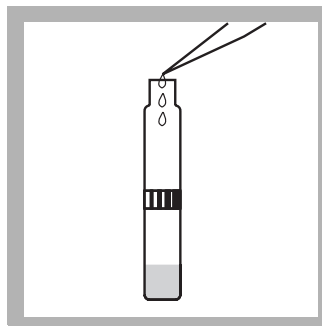

3. Carefully pipet 0.4 mL (400 µL) of sample into the vial.

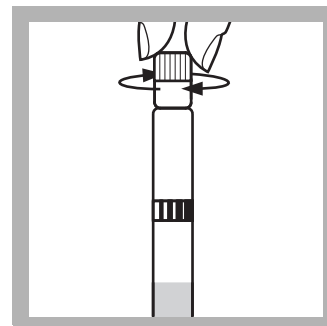

4. Flip the DosiCap Zip over so the reagent side faces the vial. Screw the cap tightly onto the vial.

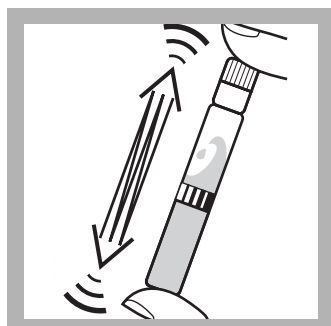

5. Shake the vial 2–3 times to dissolve the reagent in the cap.

Verify that the reagent has dissolved by looking down through the open end of the DosiCap Zip.

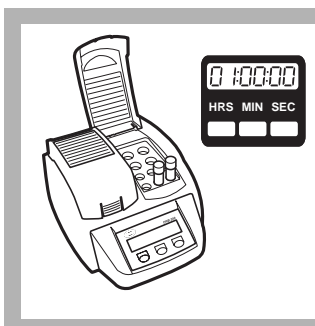

6. Insert the vial in the DRB200 Reactor. Close the protective cover. Heat for 1 hour at 100 °C.

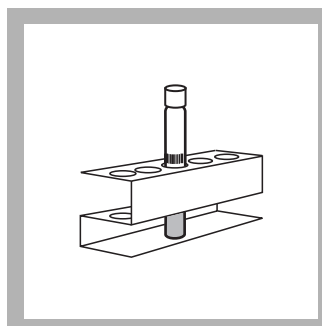

7. After the timer expires, carefully remove the hot vial from the reactor. Insert them in a test tube rack and allow to cool to room temperature (15–25 °C).

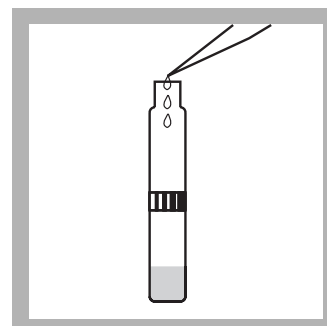

8. Pipet 0.5 mL (500 µL) of Reagent B into the cooled vial. Immediately close the Reagent B container.

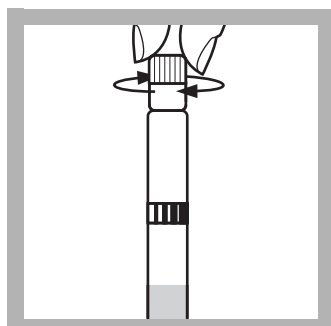

9. Screw a gray DosiCap C onto the vial.

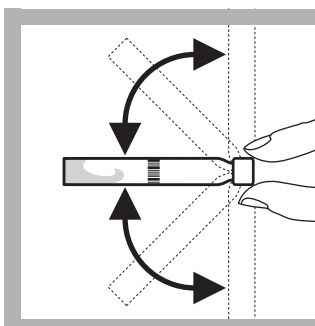

10. Invert the vial 2–3 times to dissolve the reagent in the DosiCap.



11. Wait 10 minutes. Install the Light Shield in Cell Compartment #2.

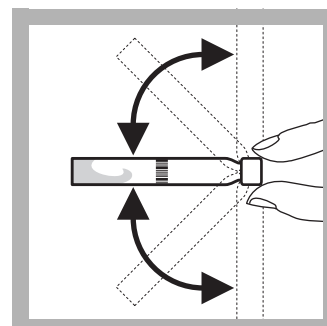

12. When the timer expires, invert the vial again 2–3 times.

Phosphorus, Reactive (Orthophosphate) and Total UHR (6 to 60 mg/L PO₄³⁻ or 2 to 20 mg/L PO₄-P)



13. Clean the outside of the vial and insert it into the cell holder. The instrument reads the barcode, then selects and performs the correct test.

Results are in mg/L PO₄.

No instrument Zero is required.

TNTplus—Phosphorus, Reactive

Method 10209

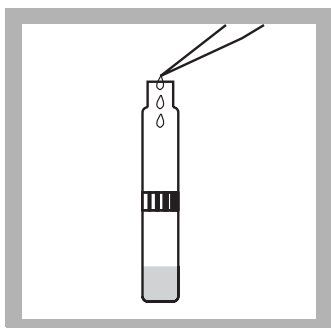

1. Carefully pipet 0.4 mL (400 µL) of sample into the vial.

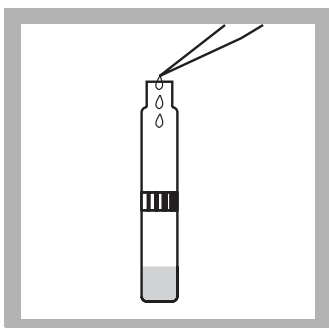

2. Pipet 0.5 mL (500 µL) of Reagent B into the vial. Immediately close the Reagent B container.

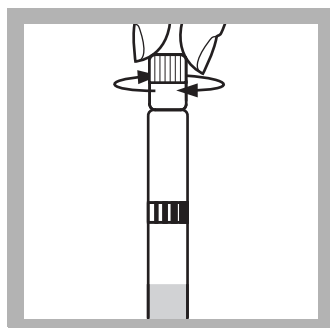

3. Screw a grey DosiCap C onto the vial.

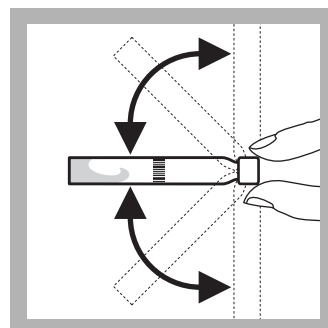

4. Invert the vial 2–3 times to dissolve the reagent in the DosiCap.

Phosphorus, Reactive (Orthophosphate) and Total UHR (6 to 60 mg/L PO₄³⁻ or 2 to 20 mg/L PO₄-P)



5. Wait 10 minutes.
Install the Light Shield in Cell Compartment #2.

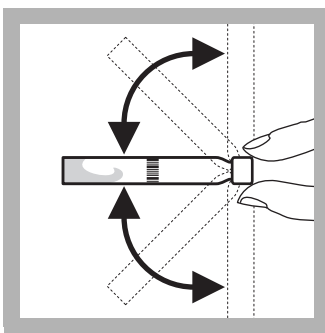

6. When the timer expires, invert the vial again 2–3 times.

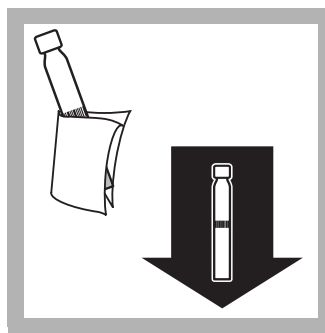

7. Clean the outside of the vial and insert it into the cell holder. The instrument reads the barcode, then selects and performs the correct test.

Results are in mg/L PO₄.

No instrument Zero is required.

Reagent Blanks

A reagent blank can be measured, and the value subtracted from the results of each test performed using the same reagent lot number. Use deionized water in place of sample and run the procedure as described.

To subtract the value of the blank from a series of measurements, measure the blank per step 13 of the total phosphorus procedure or step 7 of the reactive phosphorus procedure. Press **OPTIONS>MORE>REAGENT BLANK**. Press **ON**. The measured value of the blank should be displayed in the highlighted box. Press **OK** to accept this value. The reagent blank value will now be subtracted from all results until the function is turned off, or a different method is selected. Alternately, the blank can be recorded and entered at any later time by pressing the highlighted box and using the keypad to enter the value.

Sample Blanks

Color or turbidity in samples can cause high results. The digestion in the total phosphate procedure usually destroys all color and turbidity and a sample blank is not required.

To compensate for color or turbidity in the reactive phosphate procedure the color forming reagent that is present in the DosiCap C is not added.

To determine the sample blank run the reactive procedure as given, but do not add the DosiCap C in step 3. Cap the vial with the original DosiCap **Zip** (do not remove the foil). Use the side of the cap without the reagent. The value obtained in step 7 is then subtracted from the value obtained on the original reactive phosphate sample to give the corrected sample concentration.

Alternatively, reactive phosphate samples that contain only turbidity may be first filtered through a membrane filter and then analyzed. Samples without color or turbidity do not require sample blanks.

Interferences

The ions listed in [Table 1](#) have been individually checked up to the given concentrations and do not cause interference. Cumulative effects and the influence of other ions have not been determined. Measurement results can be verified using sample dilutions or standard additions.

Table 1 Interfering Substances and Levels

Interfering Substance	Interference Level
SO ₄ ²⁻	5000 mg/L
Cl ⁻	2000 mg/L
K ⁺ , Na ⁺ , Ca ²⁺	1000 mg/L
Mg ²⁺ , NO ₃ ⁻	500 mg/L
Co ²⁺ , Fe ²⁺ , Fe ³⁺ , Zn ²⁺ , Cu ²⁺ , Ni ²⁺ , I ⁻ , NO ₂ ⁻ , Cd ²⁺ , Sn ⁴⁺ , NH ₄ ⁺ , Mn ²⁺ , Al ³⁺ , Hg ²⁺ , Pb ²⁺ , SiO ₂	50 mg/L
Ag ⁺	25 mg/L
Cr ³⁺	10 mg/L
Cr ⁶⁺	5 mg/L

Sampling and Storage

Collect samples in plastic or glass bottles that have been acid cleaned with 1:1 Hydrochloric Acid Solution* and rinsed with deionized water. Do not use commercial detergents containing phosphate for cleaning glassware used in this test.

Analyze samples immediately after collection for best results. If prompt analysis is impossible, preserve samples for total phosphorus up to 28 days by adjusting the pH to 2 or less with concentrated Sulfuric Acid* (about 2 mL per liter) and storing at 4 °C. Samples to be analyzed for reactive phosphorus should not be preserved with acid. These samples should be stored at 4 °C and analyzed within 48 hours. Warm samples to 15–25 °C and neutralize with 5.0 N Sodium Hydroxide* before analysis if acid has been added. Correct for volume additions.

Accuracy Check

Standard Solution Method

1. Check the accuracy of the reactive and total phosphorus methods with a 50 mg/L phosphate standard solution. Use 0.4 mL this 50 mg/L standard in place of the sample in step 3 of the total phosphorus procedure or in step 2 of the reactive phosphorus procedure.
2. Alternately, use 0.4 mL of a Wastewater Influent Mixed Parameters Inorganics Standard in place of the sample. This standard contains 10 mg/L phosphate in the presence of several other ions such as nitrate, sulfate and ammonia.

* See [Optional Reagents and Apparatus on page 7](#).

Summary of Method

Phosphates present in organic and condensed inorganic forms (meta-, pyro-, or other polyphosphates) are first converted to reactive orthophosphate in the total phosphorus procedure. Treatment of the sample with acid and heat provides the conditions for hydrolysis of the condensed inorganic forms. Organic phosphates are also converted to orthophosphates by heating with acid and persulfate in the total phosphorus procedure. The reactive phosphorus procedure measures only the reactive (ortho) phosphorus present in the sample.

The reactive or orthophosphate ions react with molybdate and antimony ions in an acidic solution to form an antimonyl phosphomolybdate complex, which is reduced by ascorbic acid to phosphomolybdenum blue. Test results are measured at 890 nm.

Phosphorus, Reactive (Orthophosphate) and Total UHR (6 to 60 mg/L PO₄³⁻ or 2 to 20 mg/L PO₄-P)

Consumables and Replacement Items

Required Reagents

Description	Quantity/Test	Unit	Cat. No.
Phosphorus, Reactive and Total, UHR TNT845 Reagent Set	1	25/pkg	TNT845

Required Apparatus

Description	Quantity/Test	Unit	Cat. No.
DRB200 Reactor, 115 V, 9x13mm + 2x20 mm (mono block)	1	each	DRB200-01
DRB200 Reactor, 230 V, 9x13mm + 2x20 mm (mono block)	1	each	DRB200-05
Light Shield	1	each	LZV646
Pipet, variable volume, 100–1000 µL	1	each	27949-00
Pipet Tips, for 27949-00 pipet	1	400/pkg	27950-00
Test Tube Rack	1–3	each	18641-00

Recommended Standards and Apparatus

Description	Unit	Cat. No.
Phosphate Standard Solution, 50-mg/L as PO ₄ ³⁻	500 mL	171-49
Wastewater Influent Inorganics Standard for NH ₃ -N, NO ₃ -N, PO ₄ , COD, SO ₄ , TOC	500 mL	28331-49

Optional Reagents and Apparatus

Description	Unit	Cat. No.
TNTplus Reactor adapter sleeves, 16-mm to 13-mm diameter	5/pkg	28958-05
Bottle, sampling, low density poly, w/cap, 500 mL	12/pkg	20870-79
DRB200 Reactor, 115 V, 21x13 mm + 4x20 mm (dual block)	each	DRB200-02
DRB200 Reactor, 115 V, 15x13 mm + 15x13 mm (dual block)	each	DRB200-03
DRB200 Reactor, 115 V, 12x13 mm + 8x20 mm (dual block)	each	DRB200-04
DRB200 Reactor, 230 V, 21x13mm + 4x20 mm (dual block)	each	DRB200-06
DRB200 Reactor, 230 V, 15x13mm + 15x13 mm (dual block)	each	DRB200-07
DRB200 Reactor, 230 V, 12x13mm + 8x20 mm (dual block)	each	DRB200-08
Filter Holder, glass for vacuum filtration (SUVA)	each	2340-00
Filter, membrane, 47-mm, 0.45-micron, hydrophilic, polyethersulfone for SUVA	each	28947-00
Flask, filtering, glass, 1000-mL (SUVA)	each	546-53
Hydrochloric Acid Solution, 1:1	500 mL	884-49
Sodium Hydroxide, 5.0 N	1000 mL	2450-53
Sulfuric Acid, concentrated	500 mL	979-49
Tubing, rubber	12 ft	560-19



FOR TECHNICAL ASSISTANCE, PRICE INFORMATION AND ORDERING:

In the U.S.A. – Call toll-free 800-227-4224
Outside the U.S.A. – Contact the HACH office or distributor serving you.
On the Worldwide Web – www.hach.com; E-mail – techhelp@hach.com

HACH COMPANY
WORLD HEADQUARTERS
Telephone: (970) 669-3050
FAX: (970) 669-2932

Phosphorus, Reactive (Orthophosphate)

Method 10214

Molybdovanadate Method

TNTplus™ 846

(5.0 to 90.0 mg/L PO₄³⁻ or 1.6 to 30 mg/L PO₄-P)

Scope and Application: For wastewater, drinking water, boiler water, surface water, and process water



Test Preparation

Before starting the test:

Important Note: Install the light shield in Cell Compartment #2 before performing this test.

Please read Safety Advice and Expiration Date on package.

Recommended sample and reagent temperature is 15–25 °C (59–77 °F). If the test is not performed at the recommended temperature an incorrect result may be obtained.

Recommended sample pH is between 3–10.

Recommended reagent storage is 15–25 °C (59–77 °F).

TNTplus methods are activated from the Main Menu when the same vial is inserted into the sample cell holder.

Collect the following items:

Quantity

Phosphorus, Reactive TNT846 Reagent Set	1
Light Shield	1
Pipettor for 5.0 mL Sample	1
Pipettor Tip	varies

Note: Reorder information for consumables and replacement items is on page 4.

TNTplus

Method 10214

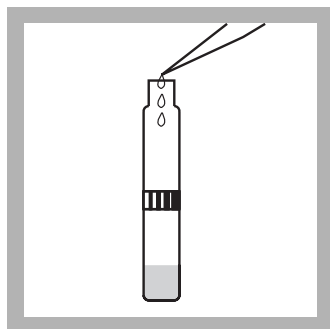

1. Pipet 5.0 mL of sample into the vial.

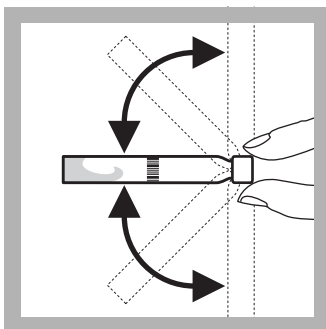

2. Cap and invert the vial gently 2–3 times.



3. Wait 10 minutes.
Install the Light Shield in Cell Compartment #2.

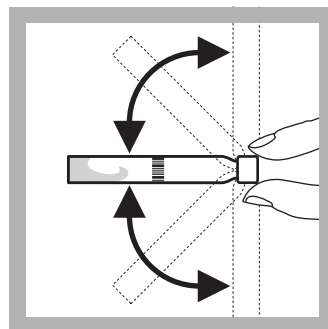

4. After the timer expires, invert the vial 2–3 times again.

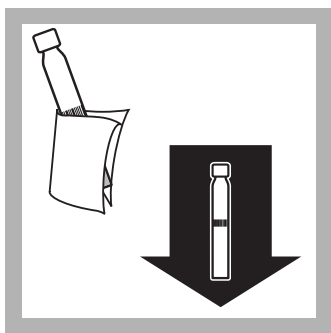

5. Clean the outside of the vial and insert it into the cell holder. The instrument reads the barcode, then selects and performs the correct test.

Results are in mg/L PO₄³⁻

No Zero is required.

Reagent Blanks

A reagent blank can be measured, and the value subtracted from the results of each test performed using the same reagent lot number. Use deionized water in place of sample and run the procedure as described.

To subtract the value of the blank from a series of measurements, measure the blank per step 5. Press **OPTIONS>MORE>REAGENT BLANK**. Press **ON**. The measured value of the blank should be displayed in the highlighted box. Press **OK** to accept this value. The reagent blank value will now be subtracted from all results until the function is turned off, or a different method is selected. Alternately, the blank can be recorded and entered at any later time by pressing the highlighted box and using the keypad to enter the value.

Sample Blanks

Color or turbidity in samples can cause high results. An optional Sample Blank Vial (TNT919) is available to correct for color or turbidity in these types of samples.

To use the Sample Blank Vial:

1. Insert the prepared sample vial for the TNT846 method into the photometer. This will launch the correct method and display the uncorrected sample result.
2. Remove the sample vial. Fill an TNT919 vial with 5.0 mL of sample and 1.0 mL of deionized water. Cap with the red stopper.
3. Insert the TNT919 Sample Blank Vial containing the untreated sample into the instrument. The barcode tells the instrument that this is the Sample Blank.

If the Sample Blank value falls within the allowable range, this value will be used to correct the result automatically. The instrument will subtract the Sample Blank from the uncorrected result. Alternatively, samples that contain only turbidity may be first filtered through a membrane filter and then analyzed. Samples without color or turbidity do not require sample blanks.

Interferences

The items listed in [Table 1](#) have been individually checked up to the given concentrations and do not cause interference. The cumulative effects and influence of other ions has not been determined. Measurement results can be verified using sample dilutions or standard additions.

Table 1 Interfering Substances and Levels

Interfering Substance	Interference Level
SO ₄ ²⁻ , Cl ⁻	1000 mg/L
K ⁺ , Na ⁺ , Ca ²⁺	500 mg/L
CO ₃ ²⁻ , Fe ²⁺ , Fe ³⁺ , NO ₃ ⁻ , Zn ²⁺ , Cu ²⁺ , Ni ²⁺ , Cr ³⁺	50 mg/L
Pb ²⁺	5 mg/L

Sampling and Storage

Collect samples in plastic or glass bottles that have been acid cleaned with 1:1 Hydrochloric Acid Solution* and rinsed with deionized water. Do not use commercial detergents containing phosphate for cleaning glassware used in this test.

Analyze samples immediately after collection for best results. If prompt analysis is impossible, preserve samples by storing at 4 °C. Samples to be analyzed for reactive phosphorus should not be preserved with acid. These samples should be analyzed within 48 hours. Warm samples to 15–25 °C and neutralize with 5.0 N Sodium Hydroxide* before analysis. Correct for volume additions.

Accuracy Check

Standard Solution Method

4. Check the accuracy of the reactive and total phosphorus methods with a 50 mg/L phosphate standard solution. Use 5.0 mL of this 50 mg/L standard in place of the sample in step 1.
5. Alternately, use 5.0 mL of a Wastewater Influent Mixed Parameters Inorganics Standard in place of the sample in step 1. This standard contains 10 mg/L phosphate in the presence of several other ions such as nitrate, sulfate and ammonia.

Summary of Method

Phosphate ions react with vanadate-molybdate reagent to form a yellow dye. Test results are measured at 435 nm.

* See [Optional Reagents and Apparatus on page 4](#).

Phosphorus, Reactive (Orthophosphate) (5.0 to 90.0 mg/L PO₄³⁻ or 1.6 to 30 mg/L PO₄-P)

Consumables and Replacement Items

Required Reagents

Description	Quantity/Test	Unit	Cat. No.
Phosphorus, Reactive TNT846 Reagent Set	1	25/pkg	TNT845

Required Apparatus

Description	Quantity/Test	Unit	Cat. No.
Light Shield	1	each	LZV646
Pipettor, variable volume, 1–5 mL	1	each	27951-00
Pipettor Tips, for 27951-00 pipettor	1	100/pkg	27952-00

Recommended Standards and Apparatus

Description	Unit	Cat. No.
Phosphate Standard Solution, 50-mg/L as PO ₄ ³⁻	500 mL	171-49
Wastewater Influent Inorganics Standard, inorganics for NH ₃ -N, NO ₃ -N, PO ₄ , COD, SO ₄ , TOC	500 mL	28331-49

Optional Reagents and Apparatus

Description	Unit	Cat. No.
Bottle, sampling, low density poly, w/cap, 500 mL	12/pkg	20870-79
Filter Holder, glass for vacuum filtration (SUVA)	each	2340-00
Filter, membrane, 47-mm, 0.45-micron, hydrophilic, polyethersulfone for SUVA	each	28947-00
Flask, filtering, glass, 1000-mL (SUVA)	each	546-53
Hydrochloric Acid 6N (1:1)	500 mL	884-49
Sample Blank Vials	—	TNT919
Sodium Hydroxide, 5.0 N	1000 mL	2450-53
Sulfuric Acid, concentrated	500 mL	979-49
Test Tube Rack, for 13-mm vials	each	24979-00
Tubing, rubber	12 ft	560-19



FOR TECHNICAL ASSISTANCE, PRICE INFORMATION AND ORDERING:
In the U.S.A. – Call toll-free 800-227-4224
Outside the U.S.A. – Contact the HACH office or distributor serving you.
On the Worldwide Web – www.hach.com; E-mail – techhelp@hach.com

HACH COMPANY
WORLD HEADQUARTERS
Telephone: (970) 669-3050
FAX: (970) 669-2932

Phosphorus, Total

PhosVer[®] 3 with Acid Persulfate Digestion
Method

★Method 8190

Test 'N Tube[™] Vials

(0.06 to 3.50 mg/L PO₄³⁻ or 0.02 to 1.10 mg/L P)

Scope and Application: For water, wastewater, and seawater; USEPA Accepted for reporting wastewater analyses



Test Preparation

Before starting the test:

Important Note: Install the light shield in Cell Compartment #2 before performing this test.

For more accurate results, determine a reagent blank value for each new lot of reagent. Follow the procedure using deionized water in place of the sample. Subtract the reagent blank value from the final results or perform a reagent blank adjust.

The test range for total phosphate is limited to 0.06 to 3.5 mg/L PO₄³⁻. Values greater than 3.5 mg/L may be used to estimate dilution ratios, but should NOT be used for reporting purposes. If the value is greater than 3.5 mg/L, dilute the sample and repeat the digestion and the colorimetric test.

Final samples will contain molybdenum. In addition, final samples will have a pH less than 2 and are considered corrosive (D002) by the Federal RCRA. Refer to the current MSDS for safe handling and disposal instructions.

Collect the following items:

Quantity

Total Phosphorus Test 'N Tube [™] Reagent Set	1
Deionized water	varies
DRB200 Reactor	1
Funnel, micro	1
Light Shield	1
Pipet, TenSette [®] , 1 to 10 mL, plus tips	
Test Tube Rack	1

Note: Reorder information for consumables and replacement items is on page 6.

Test 'N Tube

Method 8190

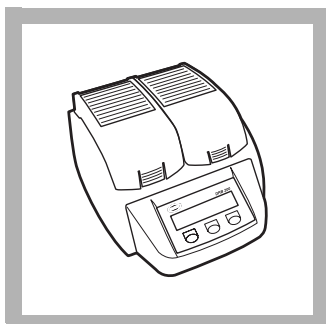

1. Turn on the DRB200 Reactor. Preheat to 150 °C.

See the DRB200 User Manual for selecting pre-programmed temperature applications.

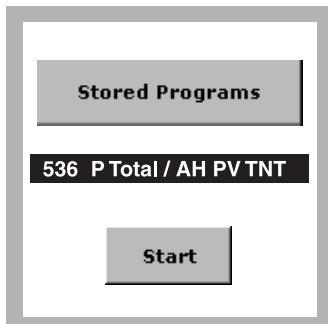

2. Select the test.
Install the Light Shield in Cell Compartment #2.

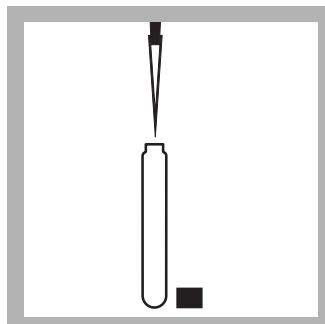

3. Use a TenSette® Pipet to add 5.0 mL of sample to a Total and Acid Hydrolyzable Test Vial.

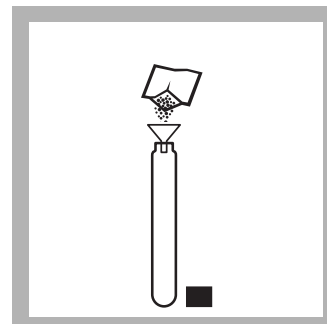

4. Use a funnel to add the contents of one Potassium Persulfate Powder Pillow for Phosphonate to the vial.

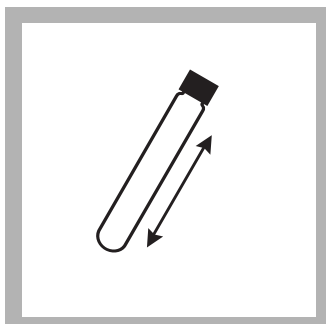

5. Cap tightly and shake to dissolve.

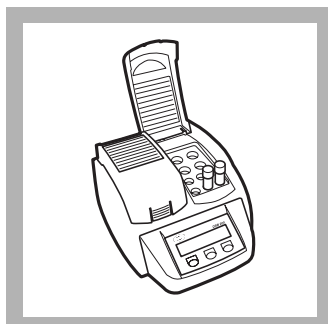

6. Insert the vial into the DRB200. Close the protective cover.



7. Press **TIMER>OK**.
A 30-minute heating period will begin.

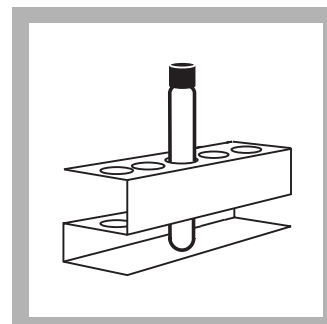

8. When the timer expires, carefully remove the hot vial from the reactor. Insert it in a test tube rack and cool to room temperature.

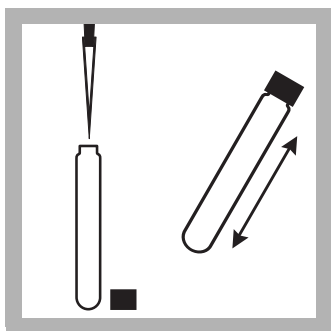

9. Use a TenSette Pipet to add 2 mL of 1.54 N Sodium Hydroxide Standard Solution to the vial. Cap and mix.



10. Wipe the outside of the vial with a damp cloth followed by a dry one.

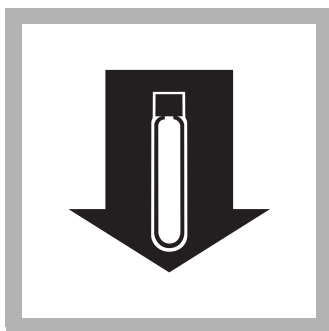

11. Insert the vial into the 16 mm cell holder.

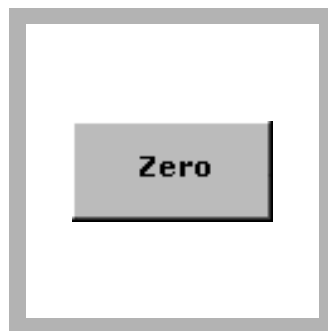

12. Press **ZERO**.
The display will show:
0.00 mg/L PO₄³⁻

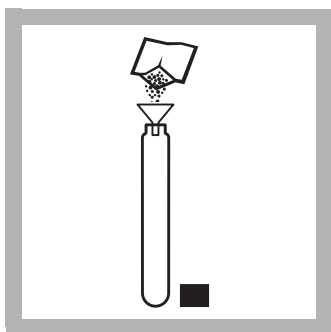

13. Use a funnel to add the contents of one PhosVer 3 Powder Pillow to the vial.

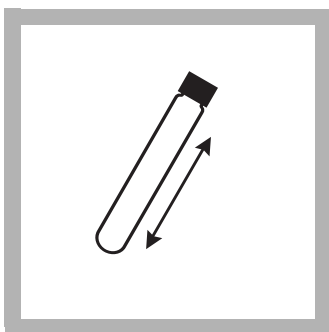

14. Immediately cap tightly and shake to mix for 20–30 seconds.
The powder will not dissolve completely.

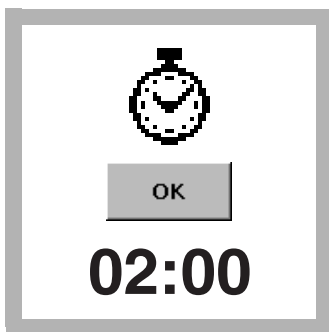

15. Press **TIMER>OK**.
A two-minute reaction period will begin.
Read the sample within 2–8 minutes after the timer expires.

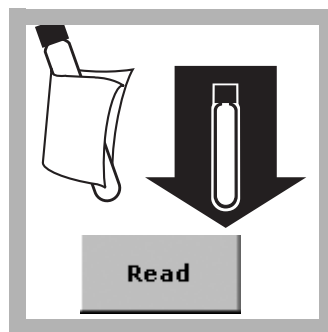

16. After the timer expires, wipe the outside of the vial with a wet towel, then a dry one. Insert the prepared sample vial into the 16 mm cell holder.
Press **READ**. Results are in mg/L PO₄³⁻.

Interferences

Table 1 Interfering Substances and Levels

Interfering Substance	Interference Levels and Treatments
Aluminum	Greater than 200 mg/L
Arsenate	Interferes at any level
Chromium	Greater than 100 mg/L
Copper	Greater than 10 mg/L
Iron	Greater than 100 mg/L
Nickel	Greater than 300 mg/L
pH, excess buffering	Highly buffered samples or extreme sample pH may exceed the buffering capacity of the reagents and require sample pretreatment.
Silica	Greater than 50 mg/L
Silicate	Greater than 10 mg/L
Sulfide	Greater than 90 mg/L
Turbidity (large amounts) or color	May cause inconsistent results because the acid in the powder pillow may dissolve some of the suspended particles and because of variable desorption of orthophosphate from the particles.
Zinc	Greater than 80 mg/L

Sample Collection, Storage, and Preservation

Collect samples in plastic or glass bottles that have been acid washed with 1:1 Hydrochloric Acid Solution* and rinsed with deionized water. Do not use commercial detergents containing phosphate for cleaning glassware used in this test.

Analyze the samples immediately for the most reliable results. If prompt analysis is not possible, samples may be preserved up to 28 days by adjusting the pH to 2 or less with concentrated Sulfuric Acid* (about 2 mL per liter) and storing at 4 °C. Warm the sample to room temperature and neutralize with 5.0 N Sodium Hydroxide* before analysis. Correct for volume additions.

Accuracy Check

Standard Additions Method (Sample Spike)

1. Clean glassware with 1:1 Hydrochloric Acid Standard Solution. Rinse again with deionized water. Do not use phosphate detergents to clean glassware.
2. After reading test results, leave the sample cell (unspiked sample) in the instrument. Verify the chemical form.
3. Press **OPTIONS>MORE**. Press **STANDARD ADDITIONS**. A summary of the standard additions procedure will appear.
4. Press **OK** to accept the default values for standard concentration, sample volume, and spike volumes. Press **EDIT** to change these values. After values are accepted, the unspiked sample reading will appear in the top row.
5. Open a Phosphate 10-mL Ampule Standard, 50-mg/L as PO₄³⁻.

* See [Optional Reagents on page 6](#).

6. Prepare three sample spikes. Fill three Mixing Cylinders* with 25 mL of sample. Use the TenSette® Pipet to add 0.1 mL, 0.2 mL, and 0.3 mL of standard, respectively, to each sample and mix thoroughly.
7. Analyze each standard addition sample as described above (use a 5-mL aliquot of the spiked sample as the sample). Accept each standard additions reading by pressing **READ**. Each addition should reflect approximately 100% recovery.
8. After completing the sequence, press **GRAPH** to view the best-fit line through the standard additions data points, accounting for the matrix interferences. Press **IDEAL LINE** to view the relationship between the sample spikes and the "Ideal Line" of 100% recovery.

Standard Solution Method

1. Use a 3.0-mg/L phosphate standard solution in place of the sample. Perform the procedure as describe above.
2. To adjust the calibration curve using the reading obtained with the 3.0-mg/L PO₄³⁻ Phosphate Standard Solution, press **OPTIONS>MORE** on the current program menu. Press **STANDARD ADJUST**.
3. Press **ON**. Press **ADJUST** to accept the displayed concentration. If an alternate concentration is used, press the number in the box to enter the actual concentration, then press **OK**. Press **ADJUST**.

Summary of Method

Phosphates present in organic and condensed inorganic forms (meta-, pyro-, or other polyphosphates) must be converted to reactive orthophosphate before analysis. Pretreatment of the sample with acid and heat provides the conditions for hydrolysis of the condensed inorganic forms. Organic phosphates are converted to orthophosphates by heating with acid and persulfate.

Orthophosphate reacts with molybdate in an acid medium to produce a mixed phosphate/molybdate complex. Ascorbic acid then reduces the complex, giving an intense molybdenum blue color. Test results are measured at 880 nm.

* See [Optional Reagents on page 6](#).

Consumables and Replacement Items

Required Reagents

Description	Quantity/Test	Unit	Cat. No.
Total Phosphorus Test 'N Tube™ Reagent Set, 50 tests, includes:	—	—	27426-45
PhosVer® 3 Phosphate Reagent Powder Pillows	1	50/pkg	21060-46
Potassium Persulfate Powder Pillows	1	50/pkg	20847-66
Sodium Hydroxide Solution, 1.54 N	2 mL	100 mL	27430-42
Total and Acid Hydrolyzable Test Vials ¹	1	50/pkg	—
Water, deionized	varies	4 L	272-56

¹ Not sold separately

Required Apparatus

Description	Quantity/Test	Unit	Cat. No.
DRB200 Reactor, 110 V, 15 x 16 mm	1	each	LTV082.53.40001
DRB200 Reactor, 220 V, 15 x 16 mm	1	each	LTV082.52.40001
Funnel, micro	1	each	25843-35
Light Shield	1	each	LZV646
Pipet, TenSette®, 1.0 to 10 mL	1	each	19700-10
Pipet Tips for TenSette Pipet 19700-10	1	250/pkg	21997-25
Pipet, volumetric, Class A, 2.00 mL	1	each	14515-36
Test Tube Rack	1–2	each	18641-00

Recommended Standards

Description	Unit	Cat. No.
Drinking Water Standard, Mixed Parameter, Inorganic for F ⁻ , NO ₃ ⁻ , PO ₄ ³⁻ , SO ₄ ²⁻	500 mL	28330-49
Phosphate Standard Solution, 10-mL Voluette® Ampule, 50-mg/L as PO ₄ ³⁻	16/pkg	171-10
Phosphate Standard Solution, 1-mg/L as PO ₄ ³⁻	500 mL	2569-49
Phosphate Standard Solution, 3 mg/L as PO ₄ ³⁻	946 mL	20597-16
Wastewater Standard, Effluent Inorganics, for NH ₃ -N, NO ₃ -N, PO ₄ , COD, SO ₄ , TOC	500 mL	28332-49

Optional Reagents

Description	Cat. No.
Cylinder, mixing, 25 mL	1896-40
Hydrochloric Acid Solution, 1:1, 500 mL	884-49
Sodium Hydroxide, 5.0 N, 1000 mL	2450-53
Sulfuric Acid, concentrated, 500 mL	979-49



FOR TECHNICAL ASSISTANCE, PRICE INFORMATION AND ORDERING:
 In the U.S.A. – Call toll-free 800-227-4224
 Outside the U.S.A. – Contact the HACH office or distributor serving you.
 On the Worldwide Web – www.hach.com; E-mail – techhelp@hach.com

HACH COMPANY
 WORLD HEADQUARTERS
 Telephone: (970) 669-3050
 FAX: (970) 669-2932

Phosphorus, Total

Molybdovanadate Method with
Acid Persulfate Digestion¹

HR (1.0 to 100.0 mg/L PO₄³⁻)

Method 10127

Test 'N Tube™ Vials

Scope and Application: For water and wastewater

¹ Adapted from *Standard Methods for the Examination of Water and Wastewater*.



Test Preparation

Before starting the test:

Important Note: Install the light shield in Cell Compartment #2 before performing this test.

Reagent blanks can be used more than once, but should not be used more than one day.

The final samples will contain molybdenum. In addition, the final samples will have a pH less than 2 and are considered corrosive (D002) by the Federal RCRA. Refer to the current MSDS for safe handling and disposal instructions.

Collect the following items:

Quantity

Total High Range Phosphorus Test 'N Tube™ Reagent Set	1
DRB200 Reactor, 15 x 16 mm	1
Light Shield	1
Pipet, TenSette®, 1 to 10 mL, plus tips	1
Test Tube Rack	1-3

Note: Reorder information for consumables and replacement items is on page 5.

Test 'N Tube

Method 10127

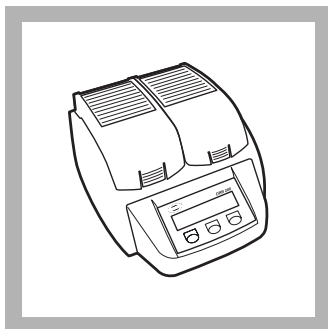

1. Turn on the DRB 200 Reactor. Heat to 150 °C.

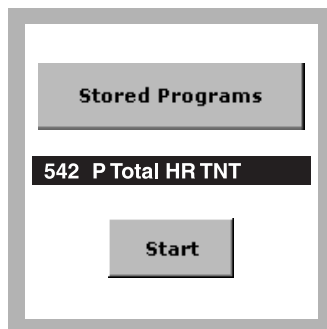

2. Select the test.
Install the Light Shield in Cell Compartment #2.

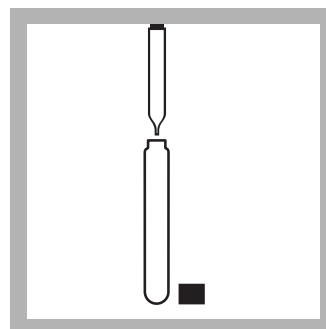

3. **Blank Preparation:**
Use a TenSette® Pipet to add 5.0 mL of deionized water to a Total Phosphorus Test 'N Tube Vial.

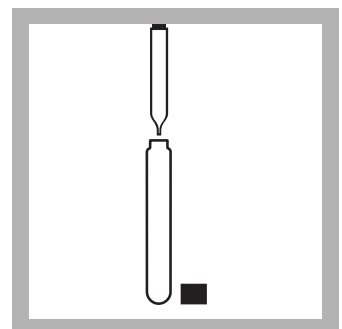

4. **Prepared Sample:**
Use a TenSette Pipet to add 5.0 mL of sample to a Total Phosphorus Test 'N Tube Vial.

Phosphorus, Total HR (1.0 to 100.0 mg/L PO₄³⁻)

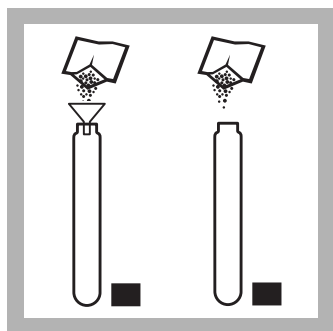

5. Use a funnel to add the contents of one Potassium Persulfate Powder Pillow to each vial.

Cap tightly and shake to dissolve.

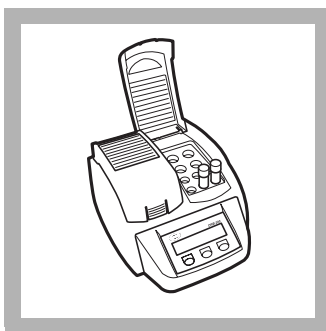

6. Insert the vials in the DRB 200 Reactor. Close the protective cover.

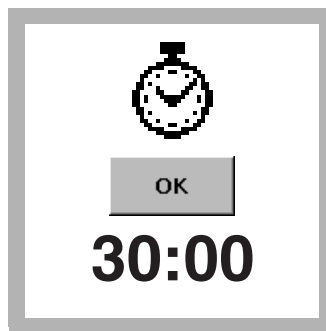

7. Press **TIMER>OK**. A 30-minute heating period will begin.

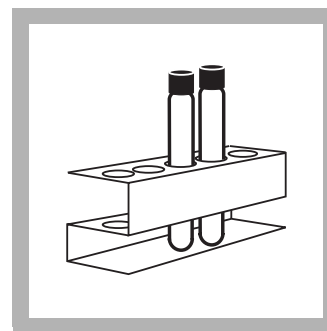

8. After the timer expires, carefully remove the hot vials from the reactor. Insert them in a test tube rack and allow to cool to room temperature (18–25 °C).

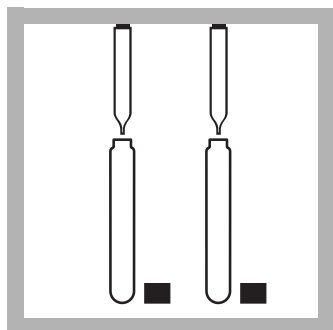

9. Use a TenSette Pipet to add 2.0 mL of 1.54 N sodium hydroxide to each vial.

Cap and invert to mix.

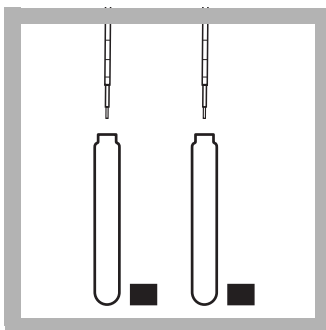

10. Use a polyethylene dropper to add 0.5 mL of Molybdovanadate Reagent to each vial.

Cap and invert to mix.

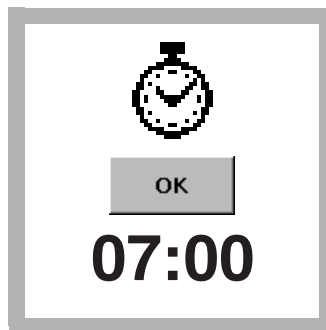

11. Press **TIMER>OK**. A 7-minute reaction period will begin. Read the sample within seven to nine minutes after adding the Molybdovanadate Reagent.

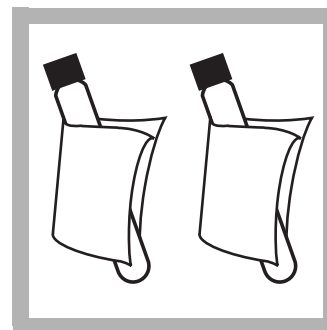

12. Wipe the vials with a damp towel, followed by a dry one, to remove fingerprints or other marks.



13. When the timer expires, insert the blank into the 16-mm cell holder.

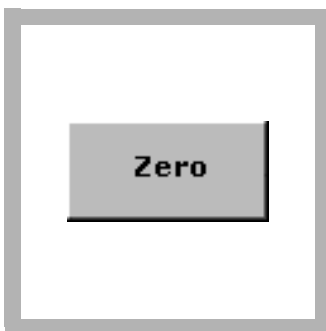

14. Press **ZERO**. The display will show: 0.0 mg/L PO₄³⁻

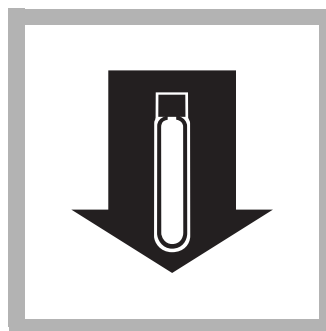

15. Insert the prepared sample into the 16-mm cell holder.

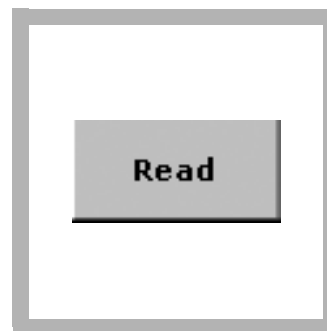

16. Press **READ**. Results are in mg/L PO₄³⁻.

Interferences

Large amounts of sample turbidity may cause inconsistent results in the test because the acid present in the reagents may dissolve some of the suspended particles and because of variable desorption of orthophosphate from the particles.

Table 1 Interfering Substances and Levels

Interfering Substance	Interference Levels and Treatments
Arsenate	Causes positive interference if the sample is warm when the molybdovanadate reagent is added (after the digestion). ¹ Cool the sample after digestion before adding reagent.
Iron, ferrous	Blue color caused by ferrous iron does not interfere if iron concentration is less than 100 mg/L.
Molybdate	Causes negative interference above 1000 mg/L.
Silica	Causes positive interference if the sample is warm when the molybdovanadate reagent is added (after the digestion). Cool the sample after digestion before adding reagent.
Extreme pH or highly buffered samples	May exceed buffering capacity of the reagents. Samples may require pretreatment. Sample pH should be about 7.
Fluoride, thorium, bismuth, thiosulfate or thiocyanate	Cause a negative interference.
Temperature, Cold (less than 18 °C)	Cause a negative interference.
Temperature, Hot (greater than 25 °C)	Causes a positive interference. Post-digestion samples should be brought to room temperature (18–25 °C) before the addition of the Molybdovanadate Reagent or sodium hydroxide.

¹ Gentle warming of the sample to reach room temperature will not cause this substance to interfere.

Table 2 Noninterfering Below 1000 mg/L

Pyrophosphate	Tetraborate	Selenate	Benzoate
Citrate	Oxalate	Lactate	Tartrate
Formate	Salicylate	Al ³⁺	Fe ³⁺
Mg ²⁺	Ca ²⁺	Ba ²⁺	Sr ²⁺
Li ⁺	Na ⁺	K ⁺	NH ₄ ⁺
Cd ²⁺	Mn ²⁺	NO ₃ ⁻	NO ₂ ⁻
SO ₄ ²⁻	SO ₃ ²⁻	Pb ²⁺	Hg ⁺
Hg ²⁺	Sn ²⁺	Cu ²⁺	Ni ²⁺
Ag ⁺	U ⁴⁺	Zr ⁴⁺	AsO ₃ ⁻
Br ⁻	CO ₃ ²⁻	ClO ₄ ⁻	CN ⁻
IO ₃ ⁻	SiO ₄ ⁴⁻	—	

Sampling and Storage

Collect samples in plastic or glass bottles that have been acid washed with 1:1 Hydrochloric Acid Solution* and rinsed with deionized water. Do not use commercial detergents containing phosphate for cleaning the glassware used in this test.

Analyze samples immediately after collection for best results. If prompt analysis is impossible, preserve samples up to 28 days by adjusting the pH to 2 or less with concentrated Sulfuric Acid* (about 2 mL per liter) and storing at 4 °C. Warm the sample to room temperature and neutralize with 5.0 N Sodium Hydroxide* before analysis. Correct for volume additions.

Accuracy Check

Standard Additions Method (Sample Spike)

1. Clean glassware with 1:1 Hydrochloric Acid Standard Solution. Rinse again with deionized water. Do not use detergents containing phosphate to clean glassware.
2. After reading test results, leave the sample cell (unspiked sample) in the instrument. Verify the chemical form.
3. Press **OPTIONS>MORE**. Press **STANDARD ADDITIONS**. A summary of the standard additions procedure will appear.
4. Press **OK** to accept the default values for standard concentration, sample volume, and spike volumes. Press **EDIT** to change these values. After values are accepted, the unspiked sample reading will appear in the top row. See the user manual for more information.
5. Snap the neck off a 10-mL Voluette[®] Ampule of Phosphate Standard Solution, 500 mg/L as PO₄³⁻.
6. Prepare three sample spikes. Fill three mixing cylinders* with 10 mL of sample. Use the TenSette Pipet to add 0.1 mL, 0.2 mL, and 0.3 mL of standard, respectively to each cylinder. Mix well.
7. Analyze each sample spike as described in the procedure above, starting with the 0.1 mL sample spike. Accept each standard additions reading by pressing **READ**. Each addition should reflect approximately 100% recovery.
8. After completing the sequence, press **GRAPH** to view the best-fit line through the standard additions data points, accounting for matrix interferences. Press **IDEAL LINE** to view the relationship between the sample spikes and the "Ideal Line" of 100% recovery.

Standard Solution Method

1. Use a 50-mg/L Phosphate standard in place of the sample. Perform the procedure as described.
2. To adjust the calibration curve using the reading obtained with the 50-mg/L PO₄³⁻ Phosphate Standard Solution, press **OPTIONS>MORE** on the current program menu. Press **STANDARD ADJUST**.
3. Press **ON**. Press **ADJUST** to accept the displayed concentration (the value depends on the selected chemical form). If an alternate concentration is used, press the number in the box to enter the actual concentration, then press **OK**. Press **ADJUST**.

* See [Optional Reagents and Apparatus on page 5](#).

Summary of Method

Phosphates present in organic and condensed inorganic forms (meta-, pyro-, or other polyphosphates) must be converted to reactive orthophosphate before analysis. Pretreatment of the sample with acid and heat provides the conditions for hydrolysis of the condensed inorganic forms. Organic phosphates are converted to orthophosphates by heating with acid and persulfate.

Orthophosphate reacts with molybdate in an acid medium to produce a mixed phosphate/molybdate complex. In the presence of vanadium, yellow molybdovanadophosphoric acid forms. The intensity of the yellow color is proportional to the phosphate concentration. Test results are measured at 420 nm.

Consumables and Replacement Items

Required Reagents

Description	Quantity/Test	Unit	Cat. No.
Total High Range Phosphorus Test 'N Tube™ Reagent Set, includes:	—	50 vials	27672-45
(1) Molybdovanadate Reagent	0.5 mL	25 mL	20760-26
(1) Potassium Persulfate powder Pillows	1	50/pkg	20847-66
(1) Sodium Hydroxide Solution, 1.54 N	2 mL	100 mL	27430-42
(1) Total Phosphorus Test Vials ¹	1	50/pkg	—
(2) Water, deionized	5 mL	100 mL	272-42

¹ Not available separately.

Required Apparatus

Description	Quantity/Test	Unit	Cat. No.
DRB200 Reactor, 110 V, 15 x 16 mm	1	each	LTV082.53.40001
DRB200 Reactor, 220 V, 15 x 16 mm	1	each	LTV082.52.40001
Light Shield	1	each	LZV646
Pipet, TenSette®, 1 to 10 mL	1	each	19700-10
Pipet Tips, for TenSette Pipet 19700-10	1	250/pkg	21997-25
Test Tube Rack	1-3	each	18641-00

Recommended Standards

Description	Unit	Cat. No.
Phosphate Standard Solution, Voluette® ampule, 500-mg/L as PO ₄ ³⁻ , 10-mL	16/pkg	14242-10
Phosphate Standard Solution, 50-mg/L as PO ₄ ³⁻	500 mL	171-49
Wastewater Standard, Influent Inorganics for NH ₃ -N, NO ₃ -N, PO ₄ , COD, SO ₄ , TOC	500 mL	28331-49

Optional Reagents and Apparatus

Description	Unit	Cat. No.
Hydrochloric Acid Solution, 1:1	500 mL	884-49
Sodium Hydroxide, 5.0 N	1000 mL	2450-53
Sulfuric Acid, concentrated	500 mL	979-49



FOR TECHNICAL ASSISTANCE, PRICE INFORMATION AND ORDERING:

In the U.S.A. – Call toll-free 800-227-4224
Outside the U.S.A. – Contact the HACH office or distributor serving you.
On the Worldwide Web – www.hach.com; E-mail – techhelp@hach.com

HACH COMPANY
WORLD HEADQUARTERS
Telephone: (970) 669-3050
FAX: (970) 669-2932

Potassium

Method 8049

Tetraphenylborate Method

Powder Pillows

(0.1 to 7.0 mg/L)

Scope and Application: For water, wastewater, and seawater



Test Preparation

Before starting the test:

Program # 905 has a calibration curve for potassium; however, due to potential variation between lots of Potassium 3 Reagent, perform a new calibration for each lot of reagent to obtain best accuracy. Prepare and store the calibration as directed under [Calibration on page 4](#).

Filter highly colored or turbid samples before analysis.

The final samples are highly acidic. Neutralize to pH 6–9 and flush to drain for disposal. Refer to a current MSDS for pollution prevention and waste management information.

After the test, clean the cells with soap and a brush.

Collect the following items:

Quantity

Potassium Reagent 1 Powder Pillow	1
Potassium Reagent 2 Powder Pillow	1
Potassium Reagent 3 Powder Pillow	1
Potassium Standard Solution, 100-mg/L	varies
Clippers	1
Cylinder, mixing, 25-mL	1
Flask, volumetric, 100-mL Class A	8
Pipet, TenSette®, 1–10 mL, plus tips	varies
Sample Cells, 1-inch square, 10-mL	2
Water, deionized	varies

Note: Reorder information for consumables and replacement items is on [page 6](#).



1. Press **USER PROGRAMS**.

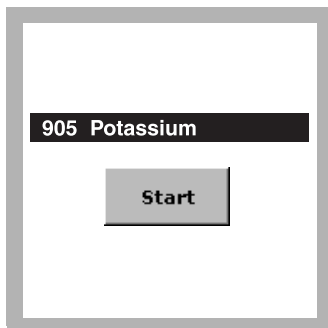

2. Select the test.
When performing this procedure for the first time the instrument must be programmed. See [User Programming on page 4](#).

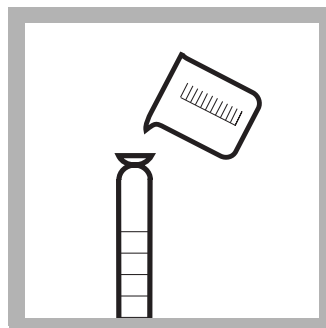

3. Fill a graduated mixing cylinder with 25 mL of sample.

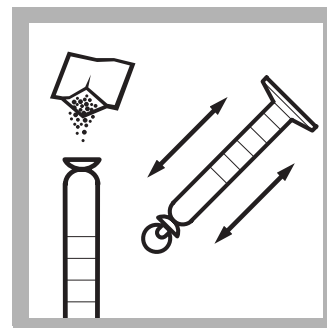

4. Add the contents of one Potassium 1 Reagent Pillow. Add the contents of one Potassium 2 Reagent Pillow. Stopper and invert several times to mix.

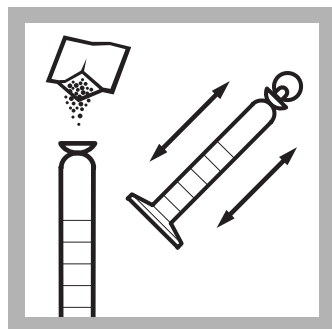

5. Add the contents of one Potassium 3 Reagent Pillow after the solution clears. Stopper and shake the solution for 30 seconds.

A white turbidity will form if potassium is present.

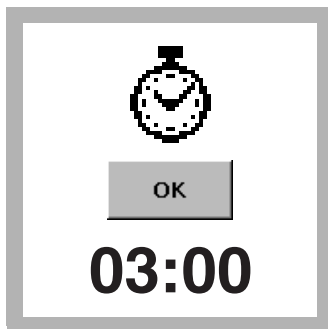

6. Press **TIMER>OK**.
A three-minute reaction period will begin.

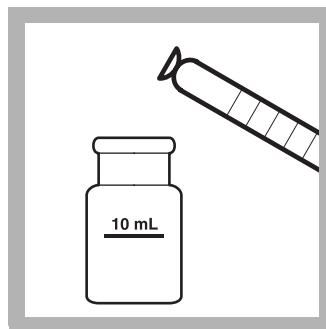

7. **Prepared Sample:**
Pour at least 10-mL of the solution from the cylinder into a square sample cell.

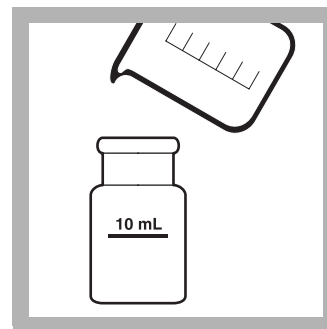

8. **Blank Preparation:**
When the timer expires, fill the second square sample cell with 10 mL of sample.

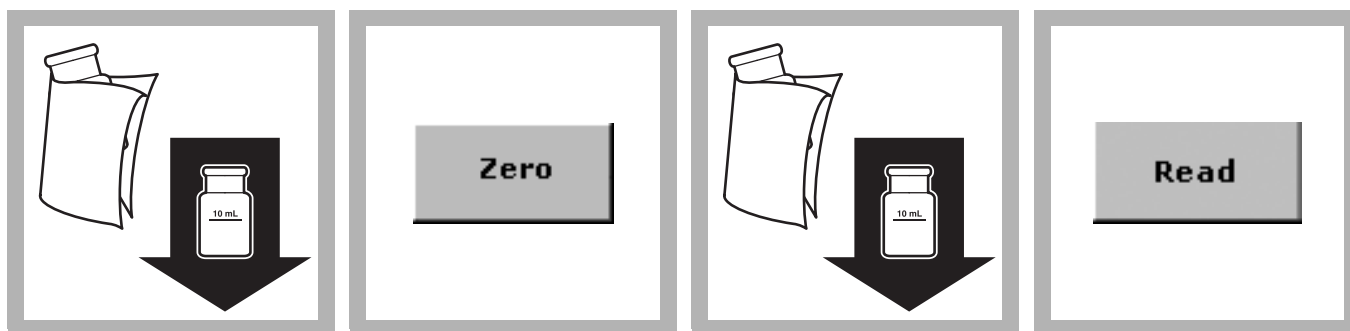

9. Wipe the blank and insert it into the cell holder with the fill line facing right.

10. Press **ZERO**.
The display will show:
0.0 mg/L K

11. Within seven minutes after the timer expires, wipe the prepared sample and insert it into the cell holder with the fill line facing right.

12. Press **READ**.
Results are in mg/L K.

Interferences

The substances listed below have been tested and will not interfere at or below the levels stated. If these substances are present at higher levels, conduct interference studies at the higher levels to determine if the substance interferes.

Table 1 Interfering Substances and Levels

Interfering Substance	Interference Levels and Treatments
Ammonium Nitrogen	15 mg/L as N
Calcium	7000 mg/L as CaCO ₃
Chloride	15,000 mg/L
Magnesium	6000 mg/L as CaCO ₃

Sample Collection, Preservation, and Storage

Collect samples in acid-washed plastic bottles. Adjust the pH to 2 or less with Nitric Acid (about 2 mL per liter)*. Preserved samples may be stored at least six months at room temperature. Before analysis, adjust the pH to 4–5 with 5.0 N Sodium Hydroxide*. Do not measure pH in the sample container with a pH electrode, as this will introduce potassium from the filling solution. Use pH Paper* or pour off sample and test pH in a separate beaker. Correct the test result for volume additions.

Accuracy Check

Standard Additions Method (Sample Spike)

Note: This procedure is applicable only to Stored Program 905, and not to User Programs.

1. After reading test results, leave the sample cell (unspiked sample) in the instrument.
2. Press **OPTIONS>MORE**. Press **STANDARD ADDITIONS**. A summary of the standard additions procedure will appear.

* See [Optional Reagents and Apparatus on page 6](#).

3. Press **OK** to accept the default values for standard concentration, sample volume, and spike volumes. Press **EDIT** to change these values. After values are accepted, the unspiked sample reading will appear in the top row. See the user manual for more information.
4. Snap the neck off a Potassium Voluette[®] Ampule Standard, 250-mg/L K.
5. Prepare three sample spikes. Fill three mixing cylinders* with 25 mL of sample. Use the TenSette[®] Pipet to add 0.1 mL, 0.2 mL, and 0.3 mL of standard, respectively, and mix thoroughly.
6. Analyze each sample spike as described in the procedure above, starting with the 0.1 mL sample spike. Accept each standard additions reading by pressing **READ**. Each addition should reflect approximately 100% recovery.
7. After completing the sequence, press **GRAPH** to view the best-fit line through the standard additions data points, accounting for matrix interferences. Press **IDEAL LINE** to view the relationship between the sample spikes and the "Ideal Line" of 100% recovery.

Calibration

Standard Preparation

An approximate calibration curve is preprogrammed within Program 905. For improved accuracy, a new calibration should be performed with each new lot of reagents. Prepare calibration standards containing 1, 2, 3, 4, 5, 6, 7, and 8 mg/L potassium as follows:

1. Into eight different 100-mL Class A volumetric flasks, pipet 1.0, 2.0, 3.0, 4.0, 5.0, 6.0, 7.0, and 8.0 mL of the 100-mg/L Potassium Standard Solution using class A glassware or TenSette Pipet.
2. Dilute to the mark with deionized water. Mix thoroughly.
3. Use deionized water for the 0-mg/L potassium standard.

User Programming

1. Press **USER PROGRAMS** on the main menu.
2. To perform the initial potassium calibration, press **PROGRAM OPTIONS** and **NEW**. Key in any available program number (950-999). Press **OK**.
3. Use the alphanumeric keys to enter a name for the potassium test into the "Program Name?" field. Press **NEXT**.
4. Set up the rest of the parameters as follows, pressing **NEXT** to move to the next screen:
 - Program Type: Single wavelength
 - Concentration Resolution: 0.1
 - Units: mg/L
 - Chemical Form: K
 - Wavelength 1 (nm): 650
 - Calibration: Read Standards
5. Press **NEXT>EXIT**.

* See [Optional Reagents and Apparatus on page 6](#).

6. To enter the remainder of the test parameters, press each line to highlight it, press **EDIT**, then enter the value specified below. Press **OK** to accept the value, and press **OK** again to return to the list. Set up the following parameters as:
 - Upper Limit: On, 8.0
 - Lower Limit: On, -0.2
 - Timer 1: Timer 3:00
 - Press Calibration: C=a + bA >Edit>OK
7. Enter the concentrations for the calibration, starting with 0.0, in the left column. (Press **+** and enter each value, then press **OK**.)
8. When all standard concentrations have been entered, press the **UP** arrow several times to move to the 0.0 line.
9. Insert the cell containing the blank (deionized water) and press **ZERO**.
10. Perform the potassium test on each standard and insert the first prepared standard into the cell holder. Press the **DOWN** arrow, if necessary, to highlight the line corresponding to this standard concentration. Press **READ**. Repeat for each standard concentration.
11. Press **GRAPH**. If the graph is acceptable, press **DONE>EXIT**. It may be possible to obtain a better fit to the data by pressing **NEXT CURVE**. The curve which results in the highest r^2 value is generally the best fit. After selection of the best curve, press **DONE>EXIT**.
12. Press **YES** in response to the "Store Program?" prompt to save the calibration.

Summary of Method

Potassium in the sample reacts with sodium tetraphenylborate to form potassium tetraphenylborate, an insoluble white solid. The amount of turbidity produced is proportional to the potassium concentration. Test results are measured at 650.

Consumables and Replacement Items**Required Reagents**

Description	Quantity/Test	Unit	Cat. No.
Potassium Reagent Set:	—	—	24591-00
Potassium Reagent 1 Powder Pillow	1	25/pkg	14321-98
Potassium Reagent 2 Powder Pillow	1	25/pkg	14322-98
Potassium Reagent 3 Powder Pillow	1	100/pkg	14323-99
Potassium Standard Solution, 100-mg/L	varies	500 mL	23517-49
Water, deionized	varies	4 L	272-56

Required Apparatus

Description	Quantity/Test	Unit	Cat. No.
Clippers	1	each	968-00
Cylinder, mixing, 25-mL	1	each	1896-40
Flask, volumetric, 100-mL Class A	8	each	14574-42
Pipet, TenSette®, 1–10 mL	1	each	19700-10
Pipet Tips, for TenSette Pipet 19700-10	varies	50/pkg	21997-96
Sample Cells, 1-inch square, 10 mL, matched pair	2	2/pkg	24954-02

Recommended Standards

Description	Unit	Cat. No.
Potassium Standard Solution, 10-mL Voluette® Ampule, 250 mg/L	16/pkg	14790-10

Optional Reagents and Apparatus

Description	Unit	Cat. No.
Nitric Acid, 1:1	500 mL	2540-49
pH Paper, 1.0–11.0	—	391-33
Sodium Hydroxide, 5.0 N	50 mL	2450-26



FOR TECHNICAL ASSISTANCE, PRICE INFORMATION AND ORDERING:
In the U.S.A. – Call toll-free 800-227-4224
Outside the U.S.A. – Contact the HACH office or distributor serving you.
On the Worldwide Web – www.hach.com; E-mail – techhelp@hach.com

HACH COMPANY
WORLD HEADQUARTERS
Telephone: (970) 669-3050
FAX: (970) 669-2932

Quaternary Ammonium Compounds

Method 8337

Direct Binary Complex Method

Powder Pillows

(0.2 to 5.0 mg/L as CTAB)

Scope and Application: For cooling tower water and pool/spa water



Test Preparation

Collect the following items:

Quantity

QAC Reagent 1 Powder Pillows	2 pillows
QAC Reagent 2 Powder Pillows	2 pillows
Bottle, square, with 25 mL mark	2
Clippers, for opening powder pillows	1
Sample Cells, 1-inch square, 10 mL, matched pair	2

Note: Reorder information for consumables and replacement items is on page 4.

Powder Pillows

Method 8337



1. Press **STORED PROGRAMS**.

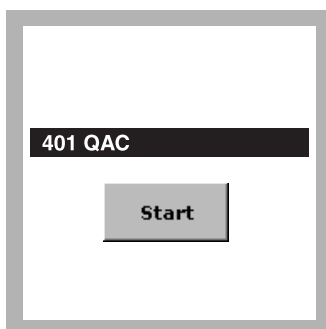

2. Select the test.

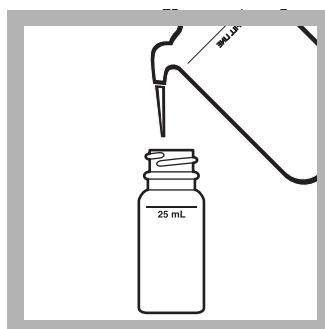

3. **Blank Preparation:** Fill one 25-mL mixing bottle with 25 mL of deionized water.

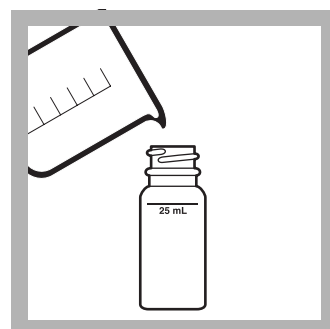

4. **Prepared Sample:** Fill another mixing bottle with 25 mL of sample.

Quaternary Ammonium Compounds (0.2 to 5.0 mg/L as CTAB)

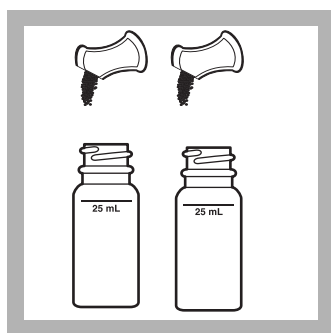

5. Add the contents of one QAC Reagent 1 Powder Pillow to each bottle.

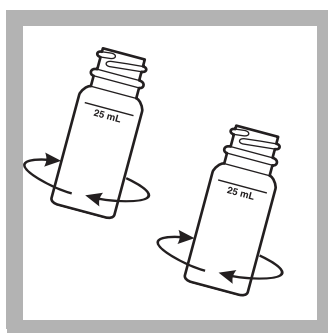

6. Swirl the bottles to dissolve the reagent. **Do not shake!** Shaking creates air bubbles that interfere with test results.



7. Add the contents of one QAC Reagent 2 Powder Pillow to each bottle.

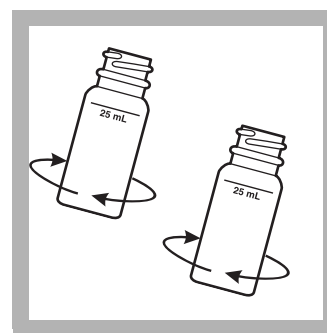

8. Swirl the bottles to dissolve the reagent. **Do not shake.**

A purple color will form if a quaternary ammonium compound is present

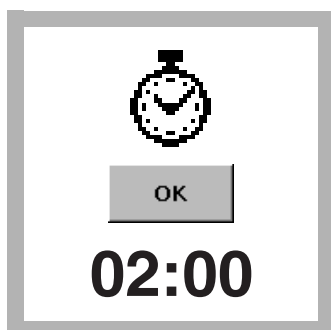

9. Press **TIMER>OK**. A two-minute reaction period will begin.

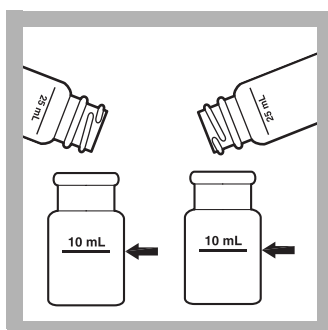

10. Pour at least 10 mL of the solutions from the bottles into square sample cells.

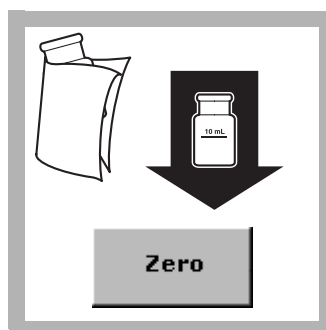

11. When the timer expires, insert the blank into the cell holder with the fill line facing right.

Press **ZERO**.

The display will show:
0.0 mg/L CTAB

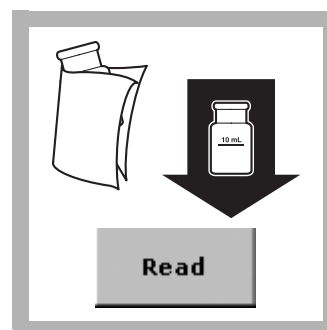

12. Insert the prepared sample into the cell holder with the fill line facing right.

Press **READ**. Results are in mg/L CTAB (cetyl-trimethylammonium bromide).

Interferences

Interference studies were conducted by preparing a CTAB standard solution of approximately 3 mg/L as well as a solution of the potential interference. The constituent was said to interfere when the resulting concentration changed by 10%.

Table 1 Interfering Substances and Levels

Interfering Substance	Interference Levels and Treatments
Calcium (as CaCO ₃)	Positive interference above 1350 mg/L
Chlorine, HOCl and OCl ⁻	Positive interference above 7 mg/L
Cyanuric acid	Negative interference above 70 mg/L
Igepal™ nonionic surfactant	Positive interference above 3 mg/L
Iodine, I ₃ ⁻	Positive interference above 3 mg/L
Iron, Fe ³⁺	Positive interference above 80 mg/L
Liquimine™ 14-P, filming amine	Positive interference above 1825 mg/L

Table 1 Interfering Substances and Levels (continued)

Interfering Substance	Interference Levels and Treatments
Magnesium, Mg ²⁺	Positive interference above 1350 mg/L
Niaproof™ anionic surfactant	Negative interference above 11 mg/L
Polyacrylic acid	Negative interference above 16 mg/L
Sodium lauryl sulfate	Negative interference above 8 mg/L
Sodium polyphosphate	Positive interference above 1325 mg/L
Tribenzylamine	Positive interference above 7 mg/L
Triton X-100™ nonionic surfactant	Positive interference above 4 mg/L
Urea	Positive interference above 8 mg/L
Highly buffered samples or extreme sample pH	May exceed the buffering capacity of the reagents and require sample pretreatment. Adjust the sample pH between 3 and 5 by using a pH meter or pH paper and adding dropwise an appropriate amount of acid or base such as 1.0 N Sulfuric Acid Standard Solution or 1.0 N Sodium Hydroxide Standard Solution. If significant volumes of acid or base are used, a volume correction should be made.

Table 2 Noninterfering Substances

Non-interfering Substance	Highest Concentration Tested (mg/L)
Silica, SiO ₂	400
Potassium alum, AlK(SO ₄) ₂	500
Sodium thiosulfate, Na ₂ S ₂ O ₃	30

After several samples have been analyzed, the sample cells may exhibit a build-up of a pink or purple color. A rinse with 1.0 N Sodium Hydroxide Solution followed by an Alconox™ detergent wash and deionized water rinse will eliminate the build-up when it occurs.

Sample Collection, Storage, and Preservation

Collect samples in glass bottles that have been rinsed several times with sample before final sample filling. Do not use plastic containers as plastic adsorbs QACs. Acidify the sample to a pH of less than 2. Store at 4 ± 2 °C.

Accuracy Check

Standard Additions Method (Sample Spike)

1. After reading test results, leave the sample cell (unspiked sample) in the instrument.
2. Press **OPTIONS>MORE**. Press **STANDARD ADDITIONS**. A summary of the standard additions procedure will appear.
3. Press **OK** to accept the default values for standard concentration, sample volume, and spike volumes. Press **EDIT** to change these values. After values are accepted, the unspiked sample reading will appear in the top row. See in the user manual for more information.
4. Open a QAC Standard Solution, 100-mg/L CTAB.
5. Prepare three sample spikes. Use a graduated cylinder to fill three mixing bottles with 25 mL of sample. Use the TenSette® Pipet to add 0.1 mL, 0.2 mL, and 0.3 mL of standard, respectively, to each sample and mix thoroughly.
6. Analyze each sample spike as described in the procedure above, starting with the 0.1 mL sample spike. Accept each standard additions reading by pressing **READ**. Each addition should reflect approximately 100% recovery.

Quaternary Ammonium Compounds (0.2 to 5.0 mg/L as CTAB)

- After completing the sequence, press **GRAPH** to view the best-fit line through the standard additions data points, accounting for matrix interferences. Press **IDEAL LINE** to view the relationship between the sample spikes and the "Ideal Line" of 100% recovery.

Standard Solution Method

Prepare a 5.0-mg/L CTAB standard solution as follows:

- Pipet 5.0 mL of QAC Standard, 100-mg/L as CTAB, into a 100-mL volumetric flask. Dilute to the mark with deionized water. Mix well. Prepare this solution daily. Perform the quaternary ammonium compound procedure as described above.
- To adjust the calibration curve using the reading obtained with the standard solution, press **OPTIONS>MORE** on the current program menu. Press **STANDARD ADJUST**.
- Press **ON**. Press **ADJUST** to accept the displayed concentration. If an alternate concentration is used, press the number in the box to enter the actual concentration, then press **OK**. Press **ADJUST**.

Summary of Method

The test method makes use of a colorimetric chemistry in which a quaternary ammonium compound reacts with an indicator to produce a color change from pale pink to vivid purple. The test is conducted in a stabilized, acid-buffered solution containing a masking agent to eliminate potential interferences. This test is applicable to the monitoring of QACs in swimming pools and cooling towers. Test results are measured at 575 nm.

Consumables and Replacement Items

Required Reagents

Description	Quantity/Test	Unit	Cat. No.
Quaternary Ammonium Compounds Reagent Set (100 tests), includes:	—	—	24592-00
(4) QAC Reagent 1 Powder Pillows	2 pillows	50/pkg	24010-66
(8) QAC Reagent 2 Powder Pillows	2 pillows	25/pkg	24012-68

Required Apparatus

Description	Quantity/Test	Unit	Cat No.
Bottle, square, with 25 mL mark	2	each	17042-00
Clippers, for opening powder pillows	1	each	968-00
Sample Cells, 1-inch square, 10 mL, matched pair	2	2/pkg	24954-02

Recommended Standards

Description	Unit	Cat. No.
QAC Standard Solution, 100-mg/L as CTAB	100 mL	24153-42
Water, deionized	4 liters	272-56

Optional Reagents and Apparatus

Description	Cat. No.
Alconox™ detergent	20880-00
Sodium Hydroxide Standard Solution, 1.0 N	1045-32
Sodium Hydroxide Solution, 1.0 N	1045-53
Sulfuric Acid Standard Solution, 1.0 N	1270-32



FOR TECHNICAL ASSISTANCE, PRICE INFORMATION AND ORDERING:
In the U.S.A. – Call toll-free 800-227-4224
Outside the U.S.A. – Contact the HACH office or distributor serving you.
On the Worldwide Web – www.hach.com; E-mail – techhelp@hach.com

HACH COMPANY
WORLD HEADQUARTERS
Telephone: (970) 669-3050
FAX: (970) 669-2932

Method 8194

Diaminobenzidine Method¹
(0.01 to 1.00 mg/L)

Scope and Application: For water and wastewater

¹ Adapted from *Standard Methods for the Examination of Water and Wastewater*.



Test Preparation

Before starting the test:

Distillation is required for determining total selenium. See [Distillation on page 5](#) at the end of the procedure. Use the distillate as the sample in step 3.

Acetone¹ is a suitable solvent for removing toluene from glassware after results are measured.

Toluene (F005) solutions are regulated as hazardous waste by the Federal RCRA. Do not pour these materials down the drain. Water saturated with toluene, toluene solutions, and the cotton plug used in the delivery tube of the separatory funnel should be collected for disposal with laboratory solvent wastes. Refer to the current MSDS for safe disposal and handling information.

If there are visible water bubbles on the bottom of the cell, decant the top portion into a clean, dry 25-mL cell prior to reading the sample.

In bright light conditions (e.g. direct sunlight) it may be necessary to close the cell compartment with the protective cover during measurements.

¹ See [Optional Reagents and Apparatus on page 8](#).

Collect the following items:**Quantity**

Buffer Solution, sulfate type, pH 2.0	10 mL
Cotton Ball	1
Cylinder, Graduated: 50- and 100-mL	1 of each
Diaminobenzidine, tetrahydrochloride	0.1 g
Distillation Reagents and Apparatus (page 8)	—
Dropper, 0.5 and 1.0 mL marks, one glass and one plastic	1 of each
Flask, Erlenmeyer, 500-mL	2
Funnel, separation	2
Hot Plate, 4-inch diameter	1
Pipet, volumetric, 5-mL, plus safety bulb filler	1
Potassium Hydroxide Standard Solution, 12 N	4 mL
Ring support (3-inch) and stand	1
Sample Cells, 1-inch square glass, 25-mL	2
Spoons, measuring, 0.2 and 0.05 g	1 of each
TitraVer® Hardness Reagent	0.4 g
Toluene, ACS	60 mL
Water, Deionized	100 mL

Note: Reorder information for consumables and replacement items is on page 7.

Diaminobenzidine

Method 8194



1. Press **STORED PROGRAMS**.

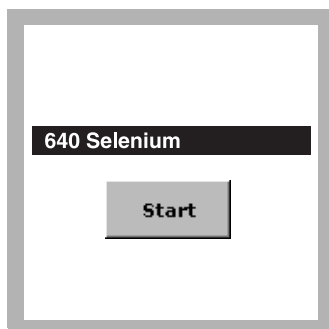

2. Select the test.

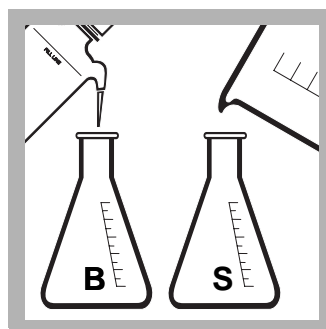

3. Measure 100 mL of deionized water into a 500-mL Erlenmeyer flask. Label the flask "blank".

Measure 100 mL of sample into a 500-mL Erlenmeyer flask. Label the flask "sample".

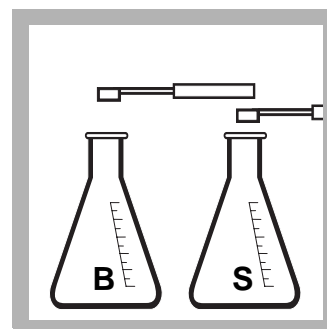

4. Add a 0.2-g spoonful of TitraVer® Hardness Reagent to each flask. Swirl to mix.

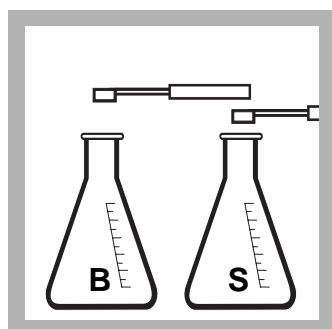

5. Add a 0.05-g spoonful of diaminobenzidine tetrahydrochloride to each flask. Swirl to mix.



6. If you have not distilled the sample, add 5.0 mL of Buffer Solution, sulfate type, pH 2.0 to each flask. Swirl to mix.

If the sample has been distilled, adjust the pH of the distillate to $\text{pH } 2.7 \pm 0.2$ using 5 N Sodium Hydroxide Standard Solution. Adjust the blank to $\text{pH } 2.7 \pm 0.2$ using 5.25 N Sulfuric Acid Standard Solution.

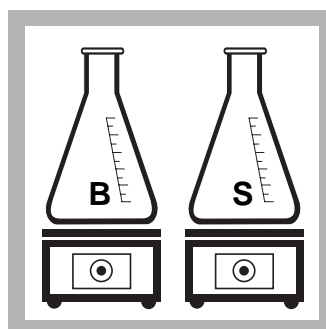

7. Heat each flask on a hot plate. Bring the contents to a gentle boil.

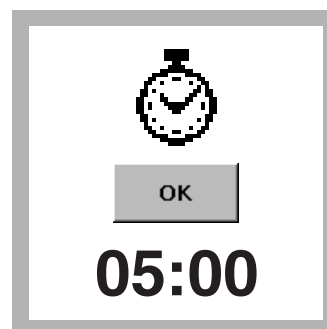

8. Press **TIMER>OK**.

A five-minute reaction period will begin. Continue to boil the contents gently during this time period.

A yellow color will develop if selenium is present.



9. When the timer expires, remove both flasks. Cool to room temperature using a water bath.

Do not boil more than one minute after the timer expires.



10. Transfer the contents of each flask to separate 250-mL separatory funnels. Label the funnels "blank" and "sample".

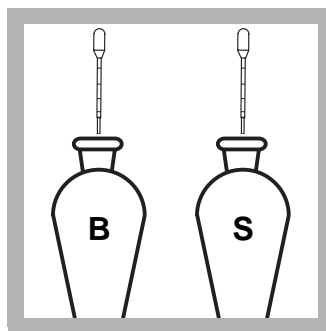

11. Add 2.0 mL of 12 N Potassium Hydroxide Standard Solution to each funnel using a calibrated 1.0-mL plastic dropper. Stopper. Shake each funnel to mix.

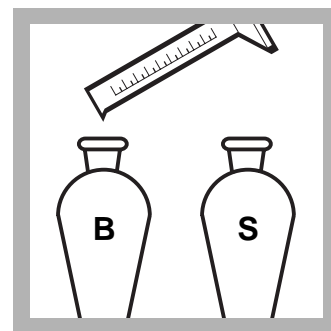

12. Add 30-mL of toluene to each funnel. Stopper. Swirl and invert each funnel, then open the stopcock to vent the funnel. Close the stopcock. Repeat twice with each funnel.

Use toluene only with adequate ventilation.

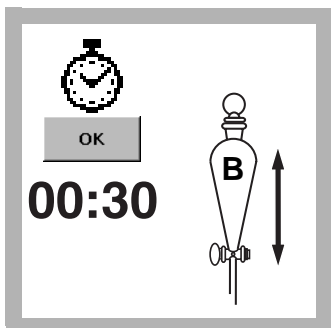

13. Press **TIMER>OK**.

A 30-second reaction period will begin. During this time, vigorously shake the funnel that contains the blank.

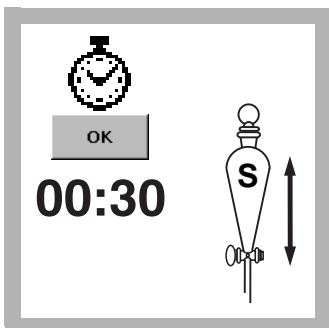

14. Press **TIMER>OK**.

A 30-second reaction period will begin. During this time, vigorously shake the funnel that contains the sample.



15. Press **TIMER>OK**.

A four-minute reaction period will begin.

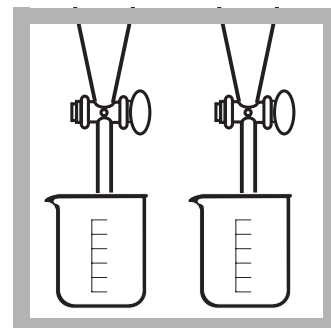

16. When the timer expires, drain the lower water layer from each funnel and discard.

Complete steps 17–20 within five minutes after the timer expires. The developed color is stable, but should be measured as soon as possible.

Selenium (0.01 to 1.00 mg/L)

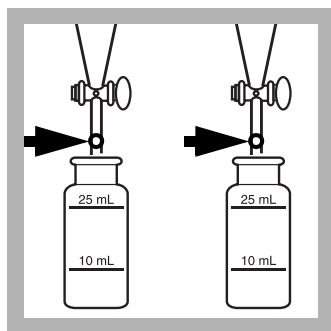

17. Insert a cotton plug into the delivery tube of each separatory funnel. Slowly drain the toluene into respective sample cells labeled “blank” and “sample”. Stopper the sample cells.

Filtering the toluene through dry, absorbent cotton will remove water or suspended particles.



18. Wipe the blank and insert it into the cell holder with the fill line facing right.

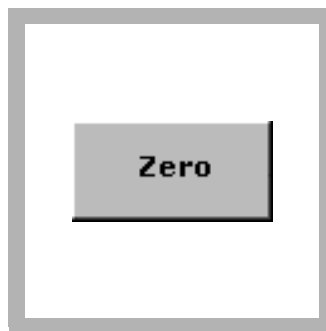

19. Press **ZERO**.
The display will show:
0.00 mg/L Se

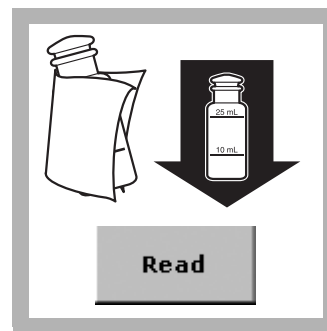

20. Wipe the prepared sample and insert it into the cell holder with the fill line facing right.

Press **READ**. Results are in mg/L Se.

Interferences

Table 1 Interfering Substances and Levels

Interfering Substance	Interference Levels and Treatments
Ferric iron	Up to 2.5 mg/L. Distill sample to eliminate interference.
Manganese	Will not interfere.
Strong oxidizing agents (i.e., iodine, bromine, or chlorine)	Can react with the indicator to give low results. Distill sample to eliminate interference.

Note: There are no positive inorganic interferences with this method.

Sample Collection, Storage, and Preservation

Collect samples in clean glass or plastic containers. Adjust the pH to 2 or less with Nitric Acid* (about 1.5 mL per liter). Preserved samples can be stored for up to six months at room temperature. Correct the test result for volume additions.

* See [Optional Reagents and Apparatus](#) on page 8.

Distillation

CAUTION

Always perform this procedure under a fume hood!

This distillation involves the use of a strong acid and oxidizer at high temperatures. To avoid personal injury, observe all laboratory safety precautions when operating the distilling apparatus.

1. Measure 500 mL of sample into a 1000-mL beaker.
2. Add 1 mL of Methyl Orange Indicator Solution. Stir with a glass rod.
3. Use a dropper to add 0.1 N Hydrochloric Acid Standard Solution dropwise until the solution becomes pink. Then add an additional 2 mL.
4. Use a pipet to add 5.0 mL Calcium Chloride Solution. Mix well.
5. Use a dropper to add 1-g/L Potassium Permanganate Standard Solution drop-wise until the solution is purple.
6. Place the beaker on a hot plate. Evaporate the solution to approximately 250 mL. Periodically add 1-g/L Potassium Permanganate Solution to keep the solution purple.
7. Any precipitate formed at this step is manganese dioxide, and may be ignored.
8. Cool the solution. While cooling, set up the distillation apparatus for the general purpose distillation as shown in the distillation manual.
9. Pour the treated sample solution into the distillation flask. Add a stirring bar to the flask.
10. Pipet 5.0 mL of 0.1 N Sodium Hydroxide Standard Solution into the flask. Turn the stirrer power switch to ON. Set the stir control to 5.
11. Turn on the water and adjust so a constant flow is maintained through the condenser. Set the heat control to 10.
12. When only a few milliliters are left in the distillation flask, turn the power switch off. The distillate in the Erlenmeyer flask may be discarded.

CAUTION

Perform step 13 under a fume hood.

13. When the flask has cooled, add 50 mL of 19.2 N Sulfuric Acid Standard Solution to the flask. Add the contents of one Potassium Bromide Powder Pillow to the flask.
14. Fill a 250-mL beaker to the 75-mL mark with deionized water. Place it under the drip tube. Elevate the beaker with a laboratory jack so the tube extends below the level of the water.
15. Add 1.0 mL of 30% hydrogen peroxide solution to the flask. Turn the stir control to 5 and the heat control to 10. Cap the distillation flask.
16. Heat the distillation flask until the yellow color is gone from the complete distillation apparatus, including the J-tube and condenser. Remove the beaker from under the drip tube.

17. Turn off the heater switch. When the J-tube and condenser have cooled, rinse them with deionized water. Add the washings to the 250-mL beaker. Total volume in the beaker should be approximately 100 mL.
18. Add the Phenol Solution drop-wise to the distilled sample to discharge the bromine color (a white precipitate of tribromophenol will form).
19. Allow the precipitate to settle. Using a dropper, collect about 5 mL of the clear, colorless distillate and transfer to a test tube.
20. Test the solution for completeness of precipitation by adding 2 drops of Phenol Solution. If the solution becomes cloudy or white precipitate forms, residual bromine is still present (proceed to next step). If no cloudiness occurs, the sample is ready for analysis.
21. Transfer the 5-mL aliquot back to the beaker and continue to add Phenol Solution until no turbidity is formed in subsequent 5-mL aliquots.
22. Transfer the entire sample into a 500-mL volumetric flask. Rinse the beaker with deionized water and add to the flask.
23. Dilute to volume with deionized water, stopper and mix well. The distillate is now ready for analysis.

Accuracy Check

Standard Additions Method (Sample Spike)

1. After reading test results, leave the sample cell (unspiked sample) in the instrument.
2. Press **OPTIONS>MORE**. Press **STANDARD ADDITIONS**. A summary of the standard additions procedure will appear.
3. Press **OK** to accept the default values for standard concentration, sample volume, and spike volumes. Press **EDIT** to change these values. After values are accepted, the unspiked sample reading will appear in the top row.
4. Prepare a 100 mg/L selenium standard solution by pipetting 10 mL of 1000 mg/L Selenium Standard Solution into a 100 mL volumetric flask, and diluting to volume with demineralized water.
5. Prepare three sample spikes. Fill three mixing cylinders with 100 mL of sample. Use the TenSette Pipet to add 0.1 mL, 0.2 mL, and 0.3 mL of standard, respectively, to each sample and mix thoroughly.
6. Analyze each sample spike as described in the procedure above, starting with the 0.1 mL sample spike. Accept each standard additions reading by pressing **READ**. Each addition should reflect approximately 100% recovery.
7. After completing the sequence, press **GRAPH** to view the best-fit line through the standard additions data points, accounting for matrix interferences. Press **VIEW: FIT**, then select **IDEAL LINE** and press **OK** to view the relationship between the sample spikes and the "Ideal Line" of 100% recovery.

Standard Solution Method

Prepare a 0.5-mg/L Se standard solution as follows:

1. Prepare a 100 mg/L selenium standard solution by pipetting 10 mL of 1000 mg/L Selenium Standard Solution into a 100 mL volumetric flask, and diluting to volume with demineralized water. Pipet 1.00 mL of this 100 mg/L standard into a 200 mL volumetric flask. Dilute to volume with deionized water. Transfer 100 mL of the standard into a 500-mL Erlenmeyer flask. Perform the test as described above.
2. To adjust the calibration curve using the reading obtained with the 0.5-mg/L standard solution, press **OPTIONS>MORE** on the current program menu. Press **STANDARD ADJUST**.
3. Press **ON**. Press **ADJUST** to accept the displayed concentration. If an alternate concentration is used, press the number in the box to enter the actual concentration, then press **OK**. Press **ADJUST**.

Summary of Method

An EDTA masking agent is added to the sample to remove interferences such as iron prior to the test. The addition of a sulfate buffer adjusts the sample to the optimum pH of 1 to 2. Under these conditions, diaminobenzidine reacts with all selenium present as selenite (Se^{4+}) to give a yellow-colored piaszelenol complex which is extracted and the color intensity measured colorimetrically. Selenium present as Se^{2+} and Se^{6+} is not detected unless the sample is distilled. Test results are measured at 420 nm.

Consumables and Replacement Items**Required Reagents**

Description	Quantity/Test	Unit	Cat. No.
Selenium Reagent Set (100 tests), includes:			22442-00
(1) Buffer Solution, sulfate type, pH 2.0	10 mL	500 mL	452-49
(1) Diaminobenzidine, tetrahydrochloride	0.1 g	5 g	7062-22
(2) Potassium Hydroxide Standard Solution, 12 N	4 mL	100 mL	230-32
(1) TitraVer® Hardness Reagent, ACS	0.4 g	100 g	204-26
(1) Toluene, ACS	60 mL	4 L	14470-17
Water, deionized	100 mL	4 L	272-56

Required Apparatus

Description	Quantity/Test	Unit	Cat. No.
Cotton Balls, absorbent	1	100/pkg	2572-01
Cylinder, graduated, 50-mL	1	each	508-41
Cylinder, graduated, 100-mL	1	each	508-42
Dropper, 0.5 & 1.0 mL marks, glass	1	5/pkg	14197-05
Dropper, 0.5 & 1.0 mL marks, plastic	1	20/pkg	21247-20
Flask, Erlenmeyer, 500-mL	2	each	505-49
Funnel, separatory, 250-mL	2	each	520-46
Hot Plate, 4-inch diameter, 120 VAC	1	each	12067-01
OR			
Hot Plate, 4-inch diameter, 240 VAC	1	each	12067-02
Pipet, volumetric, 5-mL	1	each	14515-37

Selenium (0.01 to 1.00 mg/L)

Required Apparatus (continued)

Description	Quantity/Test	Unit	Cat. No.
Pipet filler, safety bulb	1	each	14651-00
Ring, support, (3-inch) 83-mm	1	each	580-00
Sample Cells, 1-inch square, 25 mL with stopper, matched pair	2	2/pkg	26126-02
Spoon, measuring, 0.05-g	1	each	492-00
Spoon, measuring, 0.2-g	1	each	638-00
Support, ring stand, (5 x 8 inch) 127 x 203 mm	1	each	563-00

Distillation Reagents and Apparatus

Description	Unit	Cat. No.
Calcium Chloride Solution	1000 mL	428-53
Hydrochloric Acid Standard Solution, 0.1 N	1000 mL	14812-53
Hydrogen Peroxide, 30%, ACS	473 mL	144-11
Methyl Orange Indicator Solution, (0.50-g/L)	500 mL	148-49
Phenol Solution, 30-g/L	29 mL	2112-20
Potassium Permanganate Standard Solution, 1-g/L	100 mL	14164-42
Sodium Hydroxide Standard Solution, 0.100 N	1000 mL	191-53
Sulfuric Acid Standard Solution, 19.2 N	500 mL	2038-49
Distillation Apparatus Set, general purpose	each	22653-00
Distillation Apparatus Heater, 115 VAC	each	22744-00
Distillation Apparatus Heater, 230 VAC	each	22744-02

Recommended Standards

Description	Unit	Cat. No.
Selenium Standard Solution, 1000-mg/L	100 mL	22407-42

Optional Reagents and Apparatus

Description	Cat. No.
Acetone	14429-49
Nitric Acid	152-49
Sodium Hydroxide, 5.0 N	2450-32
Sulfuric Acid, 5.25 N	2449-32



FOR TECHNICAL ASSISTANCE, PRICE INFORMATION AND ORDERING:
In the U.S.A. – Call toll-free 800-227-4224
Outside the U.S.A. – Contact the HACH office or distributor serving you.
On the Worldwide Web – www.hach.com; E-mail – techhelp@hach.com

HACH COMPANY
WORLD HEADQUARTERS
Telephone: (970) 669-3050
FAX: (970) 669-2932

Method 8282

Heteropoly Blue Method¹

Pour-Thru Cell

ULR(3 to 1000 µg/L as SiO₂)

Scope and Application: For testing trace levels of soluble silica in pure and ultrapure water

¹ Adapted from *Standard Methods for the Examination of Water and Wastewater*.



Test Preparation

Before starting the test:

See the user manual for Pour-Thru Module installation instructions.

Clean the Pour-Thru cell and all labware as specified in [Labware on page 4](#)

Protect the Pour-Thru Cell from contamination when not in use by inverting a small beaker over the top of the glass funnel.

See [Reagent Preparation on page 4](#) for instructions on preparing the Amino Acid F Reagent.

Reagent blank values printed on analyzer reagent containers vary because the reagents' dilutions vary according to instrument. For this method, use the 1234D analyzer reagent blank value for a 3.78 L volume of Molybdate 3 Reagent. For a Series 5000, 2.9 L volume of Molybdate 3 Reagent, multiply the reagent blank on the label by 1.09. For 100-mL Molybdate 3 Reagent and 1 L Molybdate 3 Reagent, use the lab blank values on the bottle labels.

The four-minute reaction time in step 11 is for samples at 20 °C; for samples at 10 °C, wait eight minutes; for samples at 30 °C, wait two minutes.

The one-minute reaction time in step 13 is for samples at 20 °C; for samples at 10 °C, wait two minutes; for samples at 30 °C, wait 30 seconds.

Collect the following items:

Quantity

Amino Acid F Reagent Solution	1 mL
Citric Acid F Reagent	1 mL
Molybdate 3 Reagent	1 mL
Cylinder, graduated, 50-mL, poly	1
Flask, Erlenmeyer, 250-mL, PMP, with cap	2
Pipet, TenSette®, 0.1 to 1.0 mL with tips	1
Pour-Thru Cell Module	1

Note: Reorder information for consumables and replacement items is on [page 6](#).

Pour-Thru Cell

Method 8282

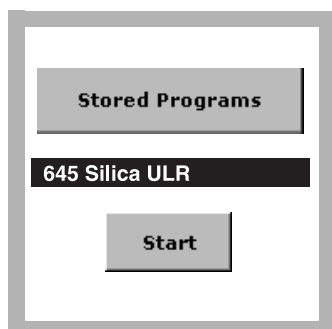

1. Select the test.

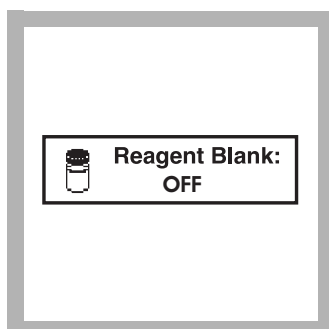

2. Account for the Molybdate 3 reagent blank by pressing **OPTIONS>MORE>REAGENT BLANK>ON**.

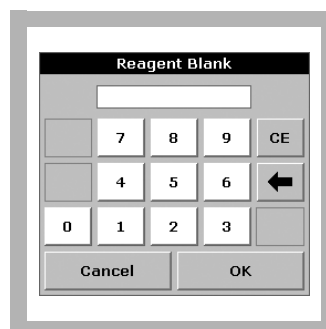

3. To adjust the reagent blank value, press the existing value and adjust it with the numeric keypad. Press **OK>OK>RETURN**.

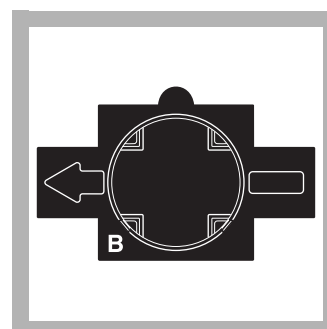

4. Insert Adapter B. Install the Pour-Thru Cell with the 1-inch (round) path in line with the adapter arrow. Flush the Pour-Thru cell with 50 mL of low-silica deionized water.

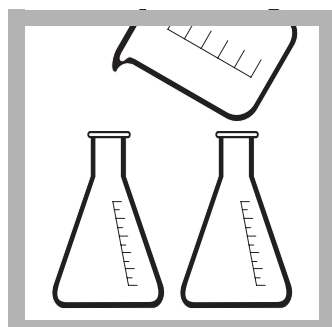

5. Fill two clean 250-mL Erlenmeyer flasks to overflowing with sample.

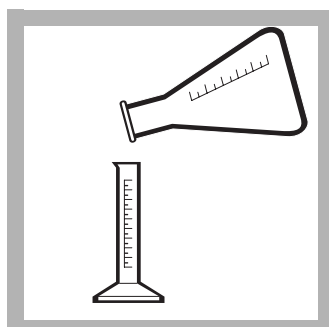

6. Fill a clean 50-mL plastic graduated cylinder with sample from one of the flasks; then discard the contents of the cylinder. Repeat three times.

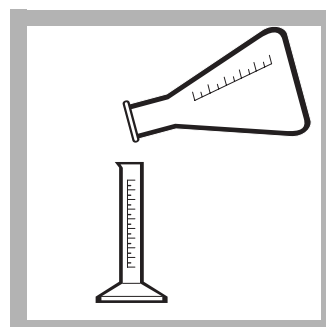

7. Fill the rinsed cylinder to the 50-mL mark with sample from the same flask. Discard any remaining sample in the flask.

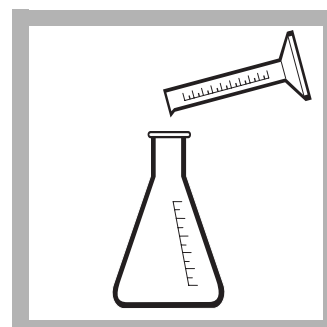

8. Pour the contents of the 50-mL cylinder back into the original flask.

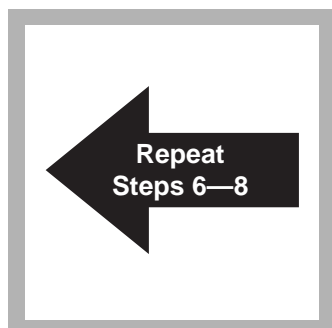

9. Repeat steps 6 through 8 for the second flask containing sample.

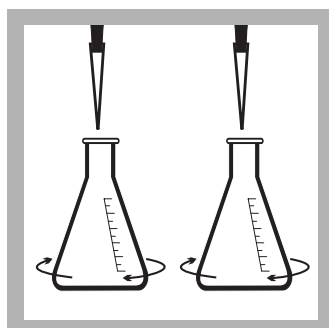

10. Use a TenSette® Pipet to add 1.0 mL of Molybdate 3 Reagent to each flask. Swirl to mix.

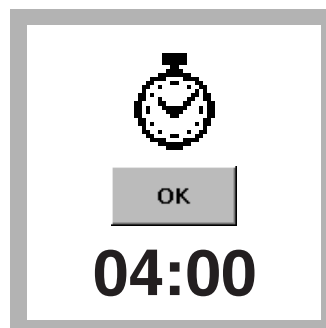

11. Press **TIMER>OK**. A four-minute reaction period will begin.

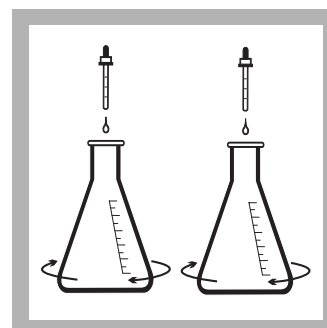

12. When the timer expires, add 1.0 mL of Citric Acid F Reagent to each flask. Swirl to mix.



13. Press **TIMER>OK.**
A one-minute reaction period will begin. The destruction of possible phosphate interference occurs during this period.



14. When the timer expires, pour the contents of one flask into the Pour-Thru Cell.

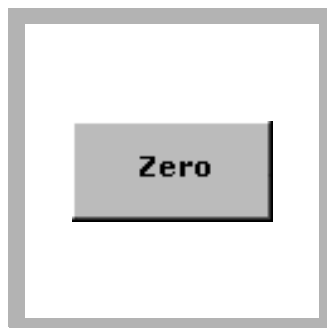

15. After the flow stops, press **ZERO.**
The display will show:
0 µg/L SiO₂

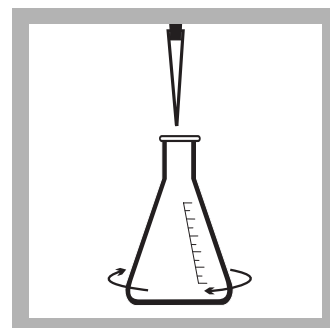

16. Add 1.0 mL of Amino Acid F Reagent to the remaining flask. Swirl to mix.
A faint blue color will develop if silica is present.

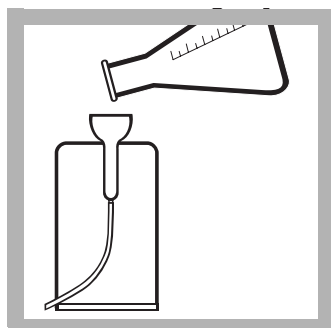

17. Wait at least 15 seconds, then pour the contents of the second flask into the Pour-Thru Cell.

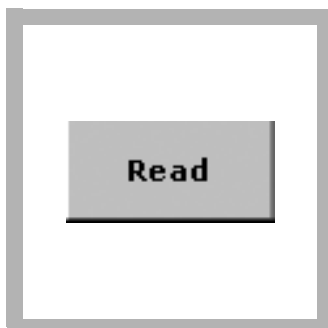

18. Press **READ.**
Results are in µg/L SiO₂.

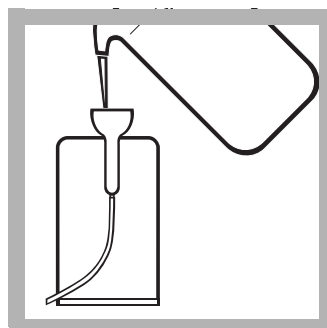

19. Flush the Pour-Thru Cell with at least 50 mL of deionized water immediately after use.

Interferences

Table 1 Interfering Substances and Levels

Interfering Substance	Interference Levels and Treatments
Color	Eliminated by zeroing the instrument with the original sample (follow procedure).
Iron	Interferes at high levels.
pH (extreme)	Adjust pH to less than 7.
Phosphate (PO ₄ ³⁻)	Interferes at levels greater than 50 mg/L PO ₄ ³⁻ .
Sulfides	Interfere at all levels.
Turbidity	Eliminated by zeroing the instrument with the original sample (follow procedure).

Sample Collection, Storage, and Preservation

Use only plastic containers with tight-fitting closures. Do not use glass containers; they will contaminate the sample with silica. Soak sampling containers with a solution made of one part Molybdate 3 Reagent to 50 parts of high quality deionized water of low silica concentration. Fill completely and let stand for several hours. Rinse thoroughly with low-level silica water, drain and close. Repeat this cleaning periodically.

Allow the sample stream to flow for 1–2 minutes before collection. Do not adjust the flow during the sampling period as this may introduce particulates. Rinse the container well with sample before collecting the portion for analysis. Analyze as soon as possible.

Reagent Preparation

Amino Acid F Reagent Solution is available in either 100-mL bottles or a package of 20 unit-dose ampules. The bottled reagent is stable for up to one year if the bottle is kept closed when not in use. The ampuled reagent is sealed under argon and is more stable with a shelf life greater than 1 year. Reduced sensitivity at high concentrations (1000 µg/L) indicates reagent instability. Check the bottled reagent on a routine basis by performing an analysis on a 1-mg/L Silica Standard Solution. If the concentration is less than 950 µg/L, use a fresh bottle of Amino Acid F Reagent Solution.

Prepare larger or smaller volumes of Amino Acid F Reagent by dissolving Amino Acid F Reagent Powder in Amino Acid F Reagent Solvent at a ratio of 11 grams per 100 mL of reagent solvent. These reagents are available as the Amino Acid F Reagent Package. This prepared solution has limited stability; test routinely with the 1-mg/L Silica Standard Solution.

Labware

All containers used in this test must be cleansed thoroughly to remove any traces of silica. Use plastic containers for all analysis and storage because glass can contaminate the sample with silica. Small bottles or flasks with screw-type closures work well.

Clean containers by normal means (do not use phosphate detergents), then rinse with high quality deionized water of low-level silica concentration. Soak for 10 minutes with a 1:50 dilution of Molybdate 3 Reagent in low-level silica water. Rinse repeatedly with either low-level silica water or the sample before use. Keep containers tightly closed when not in use. Fill the Pour-Thru Cell with this same mixture of Molybdate 3 and water, and let stand for several minutes before use. Rinse with low-level silica water.

Cleaning the Pour-Thru Cell

The Pour-Thru Cell may accumulate a buildup of colored products, especially if the reacted solutions are allowed to stand in the cell for long periods after measurement. Remove the color by rinsing with a 1:5 dilution of ammonium hydroxide, followed by several deionized water rinses. Cover the Pour-Thru Cell when it is not in use.

Accuracy Check

Standard Additions Method (Sample Spike)

1. After reading test results, leave the sample cell (unspiked sample) in the instrument. Verify the chemical form.
2. Press **OPTIONS>MORE**. Press **STANDARD ADDITIONS**. A summary of the standard additions procedure will appear.
3. Press **OK** to accept the default values for standard concentration, sample volume, and spike volumes. Press **EDIT** to change these values. After values are accepted, the unspiked sample reading will appear in the top row. See the user manual for more information.
4. Prepare three samples as instructed in the procedure. Fill three 250-mL Erlenmeyer flasks with 50 mL of sample. Use the TenSette® Pipet to add 0.2 mL, 0.4 mL, and 0.6 mL of 1-mg/L (1000-µg/L) Silica standard, respectively, to each flask and mix thoroughly.
5. Analyze each sample spike as described in the procedure above, starting with the 0.1 mL sample spike. Accept each standard additions reading by pressing **READ**. Each addition should reflect approximately 100% recovery.
6. After completing the sequence, press **GRAPH** to view the best-fit line through the standard additions data points, accounting for matrix interferences. Press **IDEAL LINE** to view the relationship between the sample spikes and the "Ideal Line" of 100% recovery.

Standard Solution Method

1. Use the 500-µg/L SiO₂ Standard Solution listed under Recommended Standards in place of the sample. Perform the silica procedure as described above.
2. To adjust the calibration curve using the reading obtained with the 500-µg/L Standard Solution, press **OPTIONS>MORE** on the current program menu. Press **STANDARD ADJUST**.
3. Press **ON**. Press **ADJUST** to accept the displayed concentration (the value depends on the selected chemical form). If an alternate concentration is used, press the number in the box to enter the actual concentration, then press **OK**. Press **ADJUST**.

Summary of Method

A number of modifications are necessary to adapt the Low Range Silica method for analyzing trace levels in the Ultra Low Range method. It is absolutely necessary to use the one-inch Pour-Thru Cell and liquid reagents. The Pour-Thru Cell increases the reproducibility of the optics and reduces the instability of the readings that result from moveable sample cells. Liquid reagents produce more reproducible readings and lower blank values by eliminating slight turbidity that may remain when using powdered reagents. Use of liquid reagents in continuous monitors for silica provides a means of confirming the analyzer performance.

Silica and phosphate in the sample react with molybdate ions under acidic conditions to form yellow silicomolybdic acid complexes and phosphomolybdic acid complexes. Addition of citric acid destroys the phosphate complexes. Amino Acid F Reagent is then added to reduce the yellow silicomolybdic acid to an intense blue color, which is proportional to the silica concentration. Test results are measured at 815 nm.

Consumables and Replacement Items

Required Reagents

Description	Quantity/Test	Unit	Cat. No.
ULR Silica Reagent Set (using Amino Acid F solution, 100 tests) Includes: (2) 1995-32, (2) 22542-32, (1) 23864-42	—	—	25535-00
ULR Silica Reagent Set (using Amino Acid F ampules, 40 tests) Includes: (1) 1995-32, (1) 22542-32, (2) 23864-20	—	—	25814-00
Amino Acid F Reagent Solution OR	1.0 mL	100 mL	23864-42
Amino Acid F Reagent Solution, 1.2-mL Ampules	1 each	20/pkg	23864-20
Citric Acid Reagent Solution	2 mL	500 mL	22542-49
Molybdate 3 Reagent Solution	2.0 mL	500 mL	1995-49

Required Apparatus

Description	Quantity/Test	Unit	Cat. No.
Adapter, for Multi-path and Pour-Thru cells	1	each	LZV585
Cylinder, graduated, 50-mL, poly	1	each	1081-41
Flask, Erlenmeyer, 250-mL, PMP, w/cap	2	each	20898-46
Pipet, TenSette®, 0.1 to 1.0 mL	1	each	19700-01
Pipet Tips, for TenSette Pipet 19700-01	5	50/pkg	21856-96
Pour-Thru Cell Kit	1	each	59404-00

Recommended Standards

Description	Unit	Cat. No.
Silica Standard Solution, 1-mg/L SiO ₂	500 mL	1106-49
Silica Standard Solution, 10-mg/L SiO ₂	500 mL	1403-49
Silica Standard Solution, 500-µg/L SiO ₂	3.78 L	21008-17
Water, deionized	4 L	272-56

Optional Reagents and Apparatus

Description	Unit	Cat. No.
Ammonium Hydroxide, 58%	500 mL	106-49
Molybdate 3 Reagent	2.9 L	1995-03
Molybdate 3 Reagent	3.78 L	1995-17
Molybdate 3 Reagent	100 mL	1995-32
Molybdate 3 Reagent	1 L	1995-53



FOR TECHNICAL ASSISTANCE, PRICE INFORMATION AND ORDERING:
 In the U.S.A. – Call toll-free 800-227-4224
 Outside the U.S.A. – Contact the HACH office or distributor serving you.
 On the Worldwide Web – www.hach.com; E-mail – techhelp@hach.com

HACH COMPANY
 WORLD HEADQUARTERS
 Telephone: (970) 669-3050
 FAX: (970) 669-2932

Method 8282

Heteropoly Blue Rapid Liquid Method¹

Pour-Thru Cell

ULR(3 to 1000 µg/L as SiO₂)

Scope and Application: For testing trace levels of soluble silica in pure and ultrapure water

¹ Adapted from *Standard Methods for the Examination of Water and Wastewater*.



Test Preparation

Before starting the test:

See the User Manual for Pour-Thru Module installation instructions.

Clean the Pour-Thru cell and all labware as specified in [Labware on page 4](#)

Protect the Pour-Thru Cell from contamination when not in use by inverting a small beaker over the top of the glass funnel.

See [Reagent Preparation on page 4](#) for instructions on preparing the Amino Acid F Reagent.

Reagent blank values printed on analyzer reagent containers vary because the reagents' dilutions vary according to instrument. For this method, use the 1234D analyzer reagent blank value for a 3.78 L volume of Molybdate 3 Reagent. For a Series 5000, 2.9 L volume of Molybdate 3 Reagent, multiply the reagent blank on the label by 1.09. For 100-mL Molybdate 3 Reagent and 1 L Molybdate 3 Reagent, use the lab blank values on the bottle labels.

The four-minute reaction time in step [11](#) is for samples at 20 °C; for samples at 10 °C, wait eight minutes; for samples at 30 °C, wait two minutes.

The one-minute reaction time in step [13](#) is for samples at 20 °C; for samples at 10 °C, wait two minutes; for samples at 30 °C, wait 30 seconds.

Collect the following items:

Quantity

Amino Acid F Reagent Powder	varies
Amino Acid Reagent Dilution Solvent	varies
Citric Acid F Reagent	1 mL
Molybdate 3 Reagent	1 mL
Cylinder, graduated, 50-mL, poly	1
Dispenser, fixed volume, 1.0-mL, w/bottle	3
Flask, Erlenmeyer, 250-mL, PMP, w/cap	2
Pour-Thru Cell Module	1

Note: Reorder information for consumables and replacement items is on [page 5](#).

Pour-Thru Cell

Method 8282

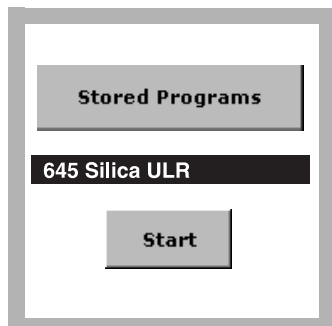

1. Select the test.

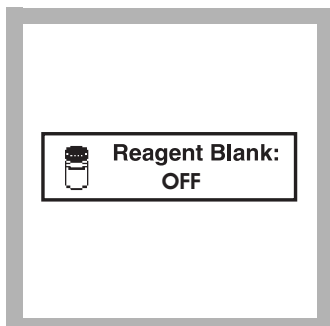

2. Account for the Molybdate 3 reagent blank by pressing **OPTIONS>MORE>REAGENT BLANK>ON**.

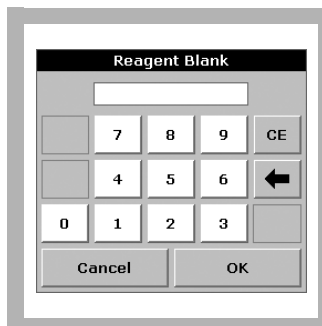

3. To adjust the reagent blank value, press the existing value and adjust it with the numeric keypad. Press **OK>OK>RETURN**.

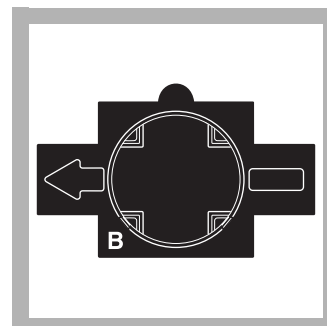

4. Insert Adapter B. Install the Pour-Thru Cell with the 1-inch (round) path in line with the adapter arrow. Flush the Pour-Thru cell with 50 mL of low-silica deionized water.

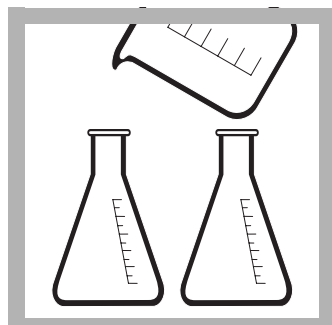

5. Fill two clean 250-mL Erlenmeyer flasks to overflowing with sample.



6. Fill a clean 50-mL plastic graduated cylinder with sample from one of the flasks; then discard the contents of the cylinder. Repeat three times.



7. Fill the rinsed cylinder to the 50-mL mark with sample from the same flask. Discard any remaining sample in the flask.

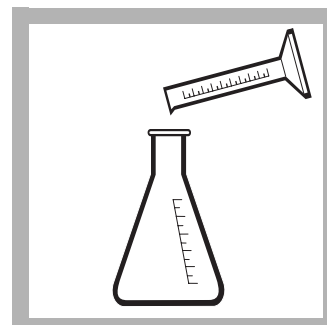

8. Pour the contents of the 50-mL cylinder back into the original flask.

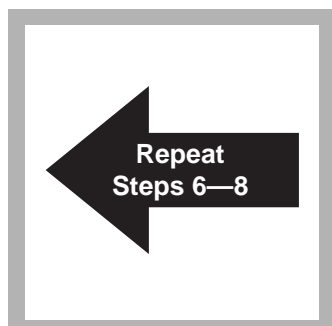

9. Repeat *step 6* through *step 8* for the second flask containing sample.

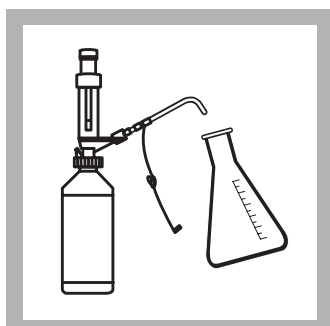

10. Add 1.0 mL of Molybdate 3 Reagent to each flask. Swirl to mix.

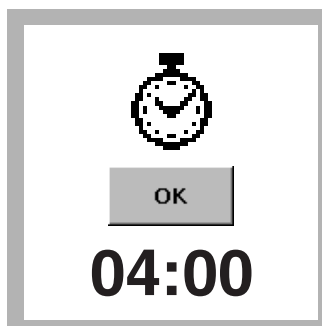

11. Press **TIMER>OK**. A four-minute reaction period will begin.

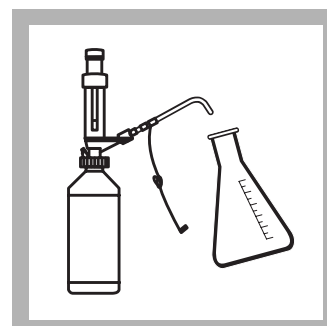

12. When the timer expires, add 1.0 mL of Citric Acid F Reagent to each flask. Swirl to mix.

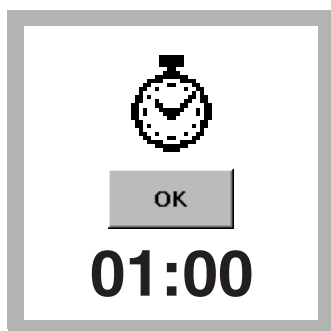

13. Press TIMER>OK.
A one-minute reaction period will begin. The destruction of possible phosphate interference occurs during this period.



14. When the timer expires, pour the contents of one flask into the Pour-Thru Cell.

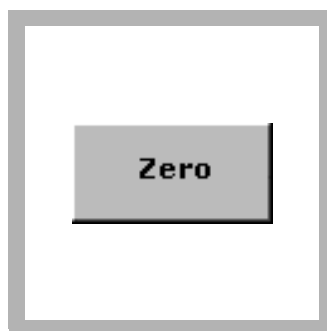

15. After the flow stops, press ZERO.
The display will show:
0 µg/L SiO₂



16. Add 1.0 mL of Amino Acid F Reagent to the remaining flask. Swirl to mix.
A faint blue color will develop if silica is present.

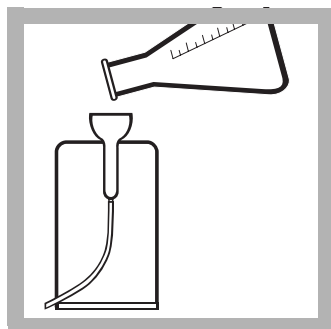

17. Wait at least 15 seconds, then pour the contents of the second flask into the Pour-Thru Cell.

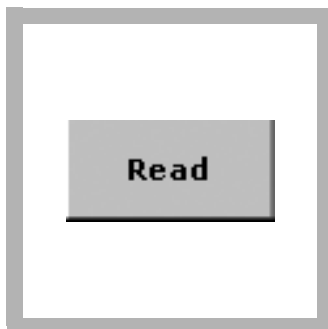

18. Press READ.
Results are in µg/L SiO₂.

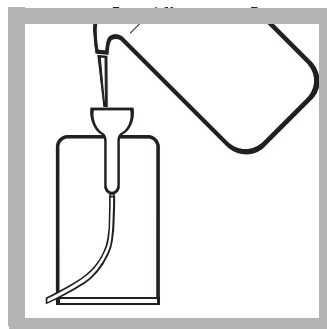

19. Flush the Pour-Thru Cell with at least 50 mL of deionized water immediately after use.

Interferences

Table 1 Interfering Substances and Levels

Interfering Substance	Interference Levels and Treatments
Color	Eliminated by zeroing the instrument with the original sample (follow procedure).
Iron	Interferes at high levels.
pH (extreme)	Adjust pH to less than 7.
Phosphate (PO ₄ ³⁻)	Interferes at levels greater than 50 mg/L PO ₄ ³⁻ .
Sulfides	Interfere at all levels.
Turbidity	Eliminated by zeroing the instrument with the original sample (follow procedure).

Sample Collection, Storage, and Preservation

Use only plastic containers with tight-fitting closures. Do not use glass containers; they will contaminate the sample with silica. Soak sampling containers with a solution made of one part Molybdate 3 Reagent to 50 parts of high quality deionized water of low silica concentration. Fill completely and let stand for several hours. Rinse thoroughly with low-level silica water, drain and close. Repeat this cleaning periodically.

Allow the sample stream to flow for 1–2 minutes before collection. Do not adjust the flow during the sampling period as this may introduce particulates. Rinse the container well with sample before collecting the portion for analysis. Analyze as soon as possible.

Reagent Preparation

Dissolve the contents of one bottle of Amino Acid F Reagent Powder in one bottle of Amino Acid Reagent Dilution Solvent. Install a bottle-top dispenser on this bottle, as well as on the Molybdate 3 Reagent and Citric Acid Reagent bottles.

Prepare smaller volumes of Amino Acid F Reagent by dissolving Amino Acid F Reagent Powder in Amino Acid F Reagent Solvent at a ratio of 11 grams per 100 mL of reagent solvent. This prepared solution has limited stability; test routinely with the 1-mg/L Silica Standard Solution.

Reduced sensitivity at high concentrations (1000 µg/L) indicates reagent instability. Check the reagent on a routine basis by performing an analysis on a 1-mg/L Silica Standard Solution. If the concentration is less than 950 µg/L, use fresh Amino Acid F Reagent Solution.

Labware

All containers used in this test must be cleansed thoroughly to remove any traces of silica. Use plastic containers for all analysis and storage because glass can contaminate the sample with silica. Small bottles or flasks with screw-type closures work well.

Clean containers by normal means (do not use phosphate detergents), then rinse with high quality deionized water of low-level silica concentration. Soak for 10 minutes with a 1:50 dilution of Molybdate 3 Reagent in low-level silica water. Rinse repeatedly with either low-level silica water or the sample before use. Keep containers tightly closed when not in use. Fill the Pour-Thru Cell with this same mixture of Molybdate 3 and water, and let stand for several minutes before use. Rinse with low-level silica water.

Cleaning the Pour-Thru Cell

The Pour-Thru Cell may accumulate a buildup of colored products, especially if the reacted solutions are allowed to stand in the cell for long periods after measurement. Remove the color by rinsing with a 1:5 dilution of ammonium hydroxide, followed by several deionized water rinses. Cover the Pour-Thru Cell when it is not in use.

Accuracy Check

Standard Additions Method (Sample Spike)

1. After reading test results, leave the sample cell (unspiked sample) in the instrument. Verify the chemical form.
2. Press **OPTIONS>MORE**. Press **STANDARD ADDITIONS**. A summary of the standard additions procedure will appear.
3. Press **OK** to accept the default values for standard concentration, sample volume, and spike volumes. Press **EDIT** to change these values. After values are accepted, the unspiked sample reading will appear in the top row. See the user manual for more information.
4. Prepare three samples as instructed in the procedure. Fill three 250-mL Erlenmeyer flasks with 50 mL of sample. Use the TenSette® Pipet to add 0.2 mL, 0.4 mL, and 0.6 mL of 1-mg/L (1000-µg/L) Silica standard, respectively, to each flask and mix thoroughly.

- Analyze each sample spike as described in the procedure above, starting with the 0.1 mL sample spike. Accept each standard additions reading by pressing **READ**. Each addition should reflect approximately 100% recovery.
- After completing the sequence, press **GRAPH** to view the best-fit line through the standard additions data points, accounting for matrix interferences. Press **IDEAL LINE** to view the relationship between the sample spikes and the "Ideal Line" of 100% recovery.

Standard Solution Method

- Use the 500-µg/L SiO₂ Standard Solution listed under Recommended Standards in place of the sample. Perform the silica procedure as described above.
- To adjust the calibration curve using the reading obtained with the 500-µg/L Standard Solution, press **OPTIONS>MORE** on the current program menu. Press **STANDARD ADJUST**.
- Press **ON**. Press **ADJUST** to accept the displayed concentration (the value depends on the selected chemical form). If an alternate concentration is used, press the number in the box to enter the actual concentration, then press **OK**. Press **ADJUST**.

Summary of Method

A number of modifications are necessary to adapt the Low Range Silica method for analyzing trace levels in the Ultra Low Range method. It is absolutely necessary to use the one-inch Pour-Thru Cell and liquid reagents. The Pour-Thru Cell increases the reproducibility of the optics and reduces the instability of the readings that result from moveable sample cells. Liquid reagents produce more reproducible readings and lower blank values by eliminating slight turbidity that may remain when using powdered reagents. Use of liquid reagents in continuous monitors for silica provides a means of confirming the analyzer performance.

Silica and phosphate in the sample react with molybdate ions under acidic conditions to form yellow silicomolybdic acid complexes and phosphomolybdic acid complexes. Addition of citric acid destroys the phosphate complexes. Amino Acid F Reagent is then added to reduce the yellow silicomolybdic acid to an intense blue color, which is proportional to the silica concentration. Test results are measured at 815 nm.

Consumables and Replacement Items

Required Reagent

Description	Quantity/Test	Unit	Cat. No.
Rapid Liquid ULR Silica Reagent Set, includes:			26785-00
Amino Acid F Reagent Powder	varies	55 g	26511-55
Amino Acid Reagent Dilution Solvent	varies	475 mL	23530-11
Citric Acid F Reagent	1 mL	500 mL	22542-49
Molybdate 3 Reagent	1 mL	500 mL	1995-49

Required Apparatus

Description	Quantity/Test	Unit	Cat. No.
Adapter, for Multi-path and Pour-Thru cells	1	each	LZV585
Cylinder, graduated, 50-mL, poly	1	each	1081-41
Dispenser, fixed volume, 1.0-mL, w/bottle	3	each	21113-02
Flask, Erlenmeyer, 250-mL, PMP, w/cap	2	each	20898-46

Silica ULR(3 to 1000 µg/L as SiO₂)

Required Apparatus

Description	Quantity/Test	Unit	Cat. No.
Pour-Thru Cell Kit	1	each	59404-00

Recommended Standards

Description	Unit	Cat. No.
Silica Standard Solution, 1-mg/L SiO ₂	500 mL	1106-49
Silica Standard Solution, 10-mg/L SiO ₂	500 mL	1403-49
Silica Standard Solution, 500-µg/L SiO ₂	3.78 L	21008-17
Water, deionized	4 L	272-56

Optional Reagents and Apparatus

Description	Unit	Cat. No.
Ammonium Hydroxide 58%	500 mL	106-49
Molybdate 3 Reagent	2.9 L	1995-03
Molybdate 3 Reagent	3.78 L	1995-17
Molybdate 3 Reagent	100 mL	1995-32
Molybdate 3 Reagent	1 L	1995-53
Pipet, TenSette®, 0.1 to 1.0 mL	each	19700-01
Pipet tips for TenSette Pipet 19700-01	50/pkg	21856-96



FOR TECHNICAL ASSISTANCE, PRICE INFORMATION AND ORDERING:
In the U.S.A. – Call toll-free 800-227-4224
Outside the U.S.A. – Contact the HACH office or distributor serving you.
On the Worldwide Web – www.hach.com; E-mail – techhelp@hach.com

HACH COMPANY
WORLD HEADQUARTERS
Telephone: (970) 669-3050
FAX: (970) 669-2932

Method 8186 Powder Pillows

Heteropoly Blue Method¹ LR (0.010 to 1.600 mg/L as SiO₂)

Scope and Application: For water and seawater

¹ Adapted from *Standard Methods for the Examination of Water and Wastewater*.



Test Preparation

Before starting the test:

The four-minute reaction time in step 5 is for samples at 20 °C; for samples at 10 °C, wait eight minutes; for samples at 30 °C, wait two minutes.

The one-minute reaction time in step 7 is for samples at 20 °C; for samples at 10 °C, wait two minutes; for samples at 30 °C, wait 30 seconds.

If testing for very low levels of silica, use Method 8282.

Collect the following items:

Quantity

Amino Acid F Reagent Powder Pillows (for 10-mL sample)	1 pillow
Citric Acid Powder Pillows	2 pillows
Molybdate 3 Reagent Solution	1 mL
Sample Cells, 1-inch square, 10 mL, matched pair	2

Note: Reorder information for consumables and replacement items is on page 4.

Powder Pillows

Method 8186



1. Press **STORED PROGRAMS**.

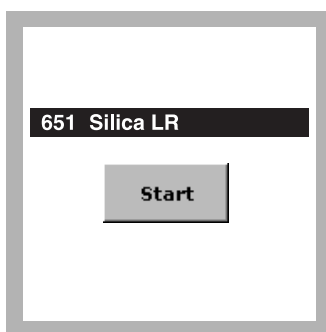

2. Select the test.

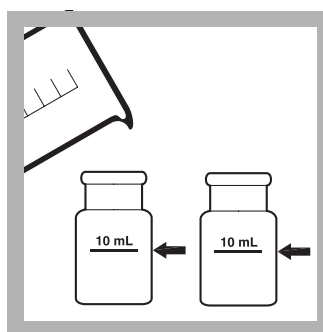

3. Fill two square sample cells with 10 mL of sample.

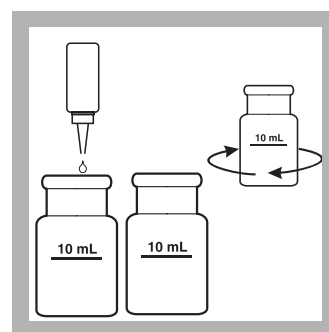

4. Add 14 drops of Molybdate 3 Reagent to each sample cell. Swirl to mix.

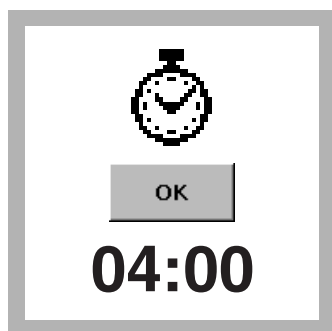

5. Press **TIMER>OK**.
A four-minute reaction period will begin.

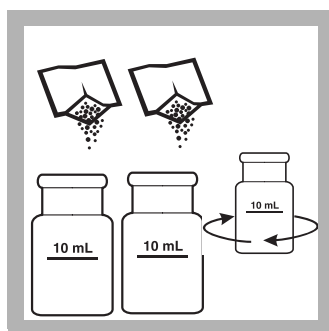

6. When the timer expires, add the contents of one Citric Acid Reagent Powder Pillow to each sample cell. Swirl to mix.

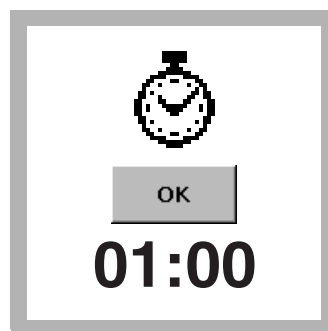

7. Press **TIMER>OK**.
A one-minute reaction period will begin. The destruction of possible phosphate interference occurs during this period.

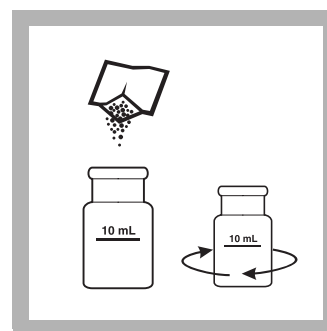

8. **Prepared Sample:**
When the timer expires, add the contents of one Amino Acid F Reagent Powder Pillow to one of the sample cells. Swirl to mix.

Blank Preparation:
The sample without the Amino Acid F Reagent is the blank.

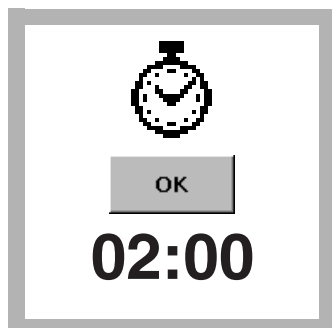

9. Press **TIMER>OK**.
A two-minute reaction period will begin.
A blue color will develop if silica is present.



10. When the timer expires, wipe the blank and insert it into the cell holder with the fill line facing right.

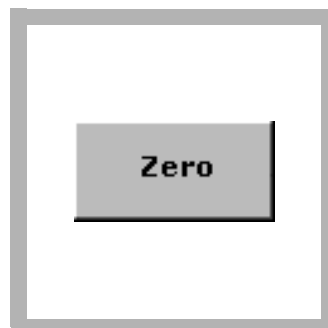

11. Press **Zero**.
The display will show:
0.000 mg/L SiO₂

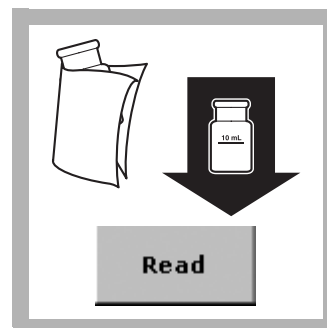

12. Wipe the prepared sample and insert it into the cell holder with the fill line facing right.
Press **READ**. Results are in mg/L SiO₂.

Interferences

Table 1 Interfering Substances and Levels

Interfering Substance	Interference Levels and Treatments
Color	Eliminated by zeroing the instrument with the original sample.
Iron	Large amounts interfere.
Phosphate	Does not interfere at levels less than 50 mg/L PO ₄ . At 60 mg/L PO ₄ , an interference of –2% occurs. At 75 mg/L PO ₄ the interference is –11%.
Slow reacting forms of silica	Occasionally a sample contains silica which reacts very slowly with molybdate. The nature of these “molybdate-unreactive” forms is not known. A pretreatment with Sodium Bicarbonate, then Sulfuric Acid will make these forms reactive to molybdate. The pretreatment is given in <i>Standard Methods for the Examination of Water and Wastewater</i> under Silica-Digestion with Sodium Bicarbonate. A longer reaction time with the sample and the molybdate and acid reagents (before adding citric acid) may help instead of the bicarbonate pretreatment.
Sulfides	Interfere at all levels.
Turbidity	Eliminated by zeroing the instrument with the original sample.

Sample Collection, Storage, and Preservation

Collect samples in clean plastic bottles. Analyze samples as soon as possible after collection. If prompt analysis is not possible, store samples for up to 7 days by cooling to 4 °C (39 °F) or below. Warm samples to room temperature before analysis.

Accuracy Check

Standard Additions Method (Sample Spike)

1. After reading test results, leave the sample cell (unspiked sample) in the instrument.
2. Press **OPTIONS>MORE**. Press **STANDARD ADDITIONS**. A summary of the standard additions procedure will appear.
3. Press **OK** to accept the default values for standard concentration, sample volume, and spike volumes. Press **EDIT** to change these values. After values are accepted, the unspiked sample reading will appear in the top row. See the user manual for more information.
4. Open a 25-mg/L Silica Standard Solution Bottle.
5. Prepare three sample spikes. Fill three sample cells with 10 mL of sample. Use the TenSette Pipet to add 0.1 mL, 0.2 mL, and 0.3 mL of standard, respectively to each sample and mix thoroughly.
6. Analyze each sample spike as described in the procedure above, starting with the 0.1 mL sample spike. Accept each standard additions reading by pressing **READ**. Each addition should reflect approximately 100% recovery.
7. After completing the sequence, press **GRAPH** to view the best-fit line through the standard additions data points, accounting for matrix interferences. Press **IDEAL LINE** to view the relationship between the sample spikes and the “Ideal Line” of 100% recovery.

Silica LR (0.010 to 1.600 mg/L as SiO₂)

Standard Solution Method

1. Use the 1.00-mg/L SiO₂ Standard Solution listed under [Consumables and Replacement Items on page 4](#) in place of the sample. Perform the silica procedure as described above.
2. To adjust the calibration curve using the reading obtained with the 1.00 mg/L Standard Solution, press **OPTIONS>MORE** on the current program menu. Press **STANDARD ADJUST**.
3. Press **ON**. Press **ADJUST** to accept the displayed concentration. If an alternate concentration is used, press the number in the box to enter the actual concentration, then press **OK**. Press **ADJUST**.

Summary of Method

Silica and phosphate in the sample react with molybdate ion under acidic conditions to form yellow silicomolybdic acid complexes and phosphomolybdic acid complexes. Addition of citric acid destroys the phosphate complexes. An Amino Acid is then added to reduce the yellow silicomolybdic acid to an intense blue color, which is proportional to the silica concentration. Test results are measured at 815 nm.

Consumables and Replacement Items

Required Reagents

Description	Quantity/Test	Unit	Cat. No.
Low Range Silica Reagent Set (100 tests), includes:	—	—	24593-00
(1) Amino Acid F Reagent Powder Pillows (for 10-mL sample)	1 pillow	100/pkg	22540-69
(2) Citric Acid Powder Pillows	2 pillows	100/pkg	21062-69
(2) Molybdate 3 Reagent Solution	1 mL	50 mL	1995-26

Required Apparatus

Description	Quantity/Test	Unit	Cat. No.
Sample Cells, 1-inch square, 10 mL, matched pair	2	2/pkg	24954-02

Recommended Standard

Description	Unit	Cat. No.
Deionized Water	4 L	272-56
Silica Standard Solution, 1-mg/L SiO ₂	500 mL	1106-49
Silica Standard Solution, 25-mg/L as SiO ₂	236 mL	21225-31

Optional Reagents and Apparatus

Description	Unit	Cat. No.
Sodium Bicarbonate	454 g	776-01
Sulfuric Acid, 1.00 N	1000 mL	1270-53
Pipet, TenSette®, 0.1–1.0 mL	each	19700-01
Pipet Tips for TenSette Pipet 19700-01	50/pkg	21856-96



FOR TECHNICAL ASSISTANCE, PRICE INFORMATION AND ORDERING:
In the U.S.A. – Call toll-free 800-227-4224
Outside the U.S.A. – Contact the HACH office or distributor serving you.
On the Worldwide Web – www.hach.com; E-mail – techhelp@hach.com

HACH COMPANY
WORLD HEADQUARTERS
Telephone: (970) 669-3050
FAX: (970) 669-2932

Method 8185 Powder Pillows

Silicomolybdate Method HR (1 to 100 mg/L)

Scope and Application: For water and seawater



Test Preparation

Before starting the test:

Sample temperature should be 15–25 °C (59–77 °F)

Collect the following items:

Quantity

High Range Silica Reagent Set

1

Deionized Water

10 mL

Sample Cell, 1-inch square, 10-mL

2

Note: Reorder information for consumables and replacement items is on page 4.

Powder Pillows

Method 8185



1. Press
STORED PROGRAMS.



2. Select the test.

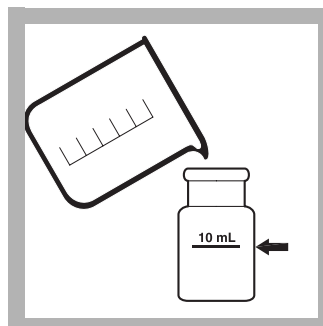

3. Fill a square sample
cell with 10-mL of sample.

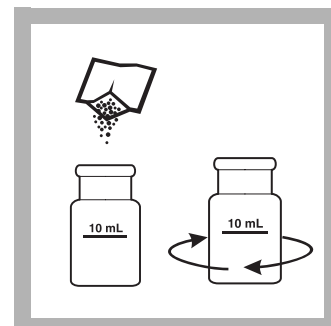

4. **Prepared Sample:**
Add the contents of one
Molybdate Reagent
Powder Pillow for High
Range Silica to the sample
cell. Swirl until completely
dissolved.

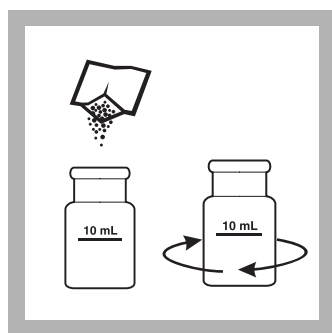

5. Add the contents of one Acid Reagent Powder Pillow for High Range Silica. Swirl to mix.

A yellow color will develop if silica or phosphorus is present.

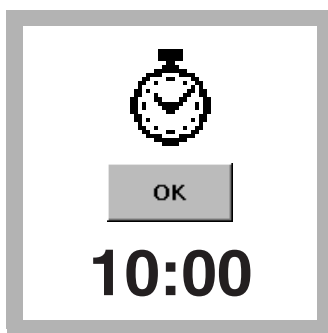

6. Press **TIMER>OK**.
A ten-minute reaction period will begin.

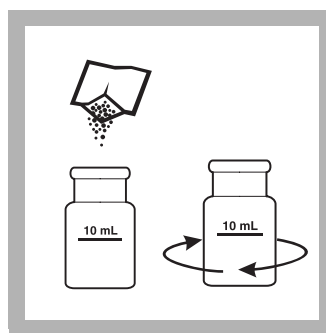

7. When the timer expires, add the contents of one Citric Acid Powder Pillow to the sample cell. Swirl to mix.

Any yellow color due to phosphorus is removed in this step.

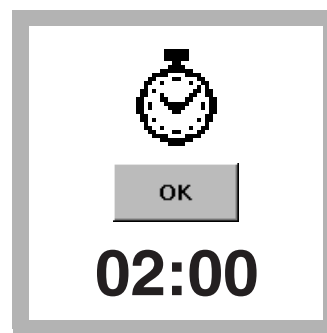

8. Press **TIMER>OK**.
A two-minute reaction period will begin.

Perform steps 9–12 within three minutes after the timer expires.

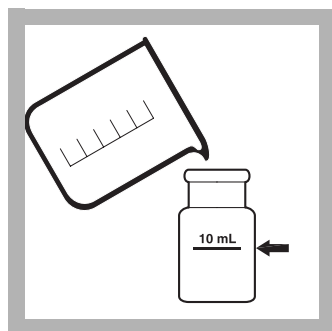

9. **Blank Preparation:**
Fill a second sample cell with 10 mL of the original sample.



10. Wipe the blank and insert the blank into the cell holder with the fill line facing right.

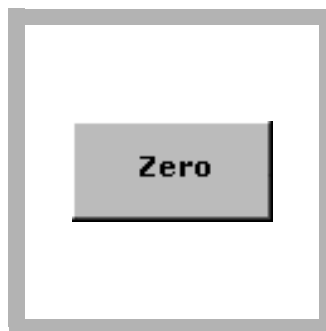

11. Press **ZERO**.
The display will show:
0 mg/L SiO₂

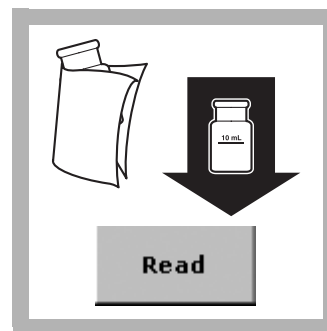

12. Wipe the prepared sample and insert the prepared sample into the cell holder with the fill line facing right.

Press **READ**. Results are in mg/L SiO₂.

Interferences

Table 1 Interfering Substances and Levels

Interfering Substance	Interference Levels and Treatments
Color	Eliminated by zeroing the instrument with the original sample.
Iron	High levels of Fe ²⁺ and Fe ³⁺ interfere.
Phosphate	Does not interfere below 50 mg/L PO ₄ ³⁻ . At 60 mg/L PO ₄ ³⁻ , a negative 2% interference occurs. At 75 mg/L PO ₄ ³⁻ , the interference is negative 11%.
Sulfides (S ²⁻)	All levels interfere.
Turbidity	Eliminated by zeroing the instrument with the original sample.

Occasionally a sample contains silica which reacts very slowly with molybdate. The nature of these "molybdate-unreactive" forms is not known. A pretreatment with Sodium Bicarbonate*, then Sulfuric Acid† will make these forms reactive to molybdate. The pretreatment is given in *Standard Methods for the Examination of Water and Wastewater* under Silica-Digestion with Sodium Bicarbonate. A longer reaction time with the sample and the molybdate and acid reagents (before adding citric acid) may help instead of the bicarbonate treatment.

Sample Collection, Storage, and Preservation

Collect samples in clean plastic bottles. Analyze samples as soon as possible after collection. If prompt analysis is not possible, store samples at 4 °C (39 °F) for up to 28 days. Warm samples to room temperature before analyzing.

Accuracy Check

Standard Additions Method (Sample Spike)

1. After reading test results, leave the sample cell (unspiked sample) in the instrument. Verify the chemical form.
2. Press **OPTIONS>MORE**. Press **STANDARD ADDITIONS**. A summary of the standard additions procedure will appear.
3. Press **OK** to accept the default values for standard concentration, sample volume, and spike volumes. Press **EDIT** to change these values. After values are accepted, the unspiked sample reading will appear in the top row. See the user manual for more information.
4. Open a 1000 mg/L Silica Standard Solution.
5. Prepare three sample spikes. Fill three sample cells with 10 mL of sample. Use the TenSette® Pipet to add 0.1 mL, 0.2 mL, and 0.3 mL of standard, respectively, to each sample and mix thoroughly.
6. Analyze each sample spike as described in the procedure above, starting with the 0.1 mL sample spike. Accept each standard additions reading by pressing **READ**. Each addition should reflect approximately 100% recovery.
7. After completing the sequence, press **GRAPH** to view the best-fit line through the standard additions data points, accounting for the matrix interferences. Press **IDEAL LINE** to view the relationship between the sample spikes and the "Ideal Line" of 100% recovery

Standard Solution Method

1. To check test accuracy, use the 50-mg/L Silica Standard Solution. Analyze according to the HR Silica procedure described above using deionized water as the blank.
2. To adjust the calibration curve using the reading obtained with the standard solution, press **OPTIONS>MORE** on the current program menu. Press **STANDARD ADJUST**.
3. Press **ON**. Press **ADJUST** to accept the displayed concentration. If an alternate concentration is used, press the number in the box to enter the actual concentration, then press **OK**. Press **ADJUST**.

* See [Optional Reagents and Apparatus on page 4](#).

† See [Optional Reagents and Apparatus on page 4](#).

Silica HR (1 to 100 mg/L)

Summary of Method

Silica and phosphate in the sample react with molybdate ion under acidic conditions to form yellow silicomolybdic acid complexes and phosphomolybdic acid complexes. Addition of citric acid destroys the phosphate complexes. Silica is then determined by measuring the remaining yellow color. Test results are measured at 452 nm.

Consumables and Replacement Items

Required Reagents

Description	Quantity/Test	Unit	Cat. No.
High Range Silica Reagent Set for 10-mL samples (100 tests), includes:			24296-00
Acid Reagent Powder Pillows for High Range Silica	1	100/pkg	21074-69
Citric Acid Powder Pillows	1	100/pkg	21062-69
Molybdate Reagent Powder Pillows for High Range Silica	1	100/pkg	21073-69
Water, deionized	10 mL	4 L	272-56

Required Apparatus

Description	Quantity/Test	Unit	Cat. No.
Sample Cells, 1-inch square, 10 mL, matched pair	2	2/pkg	24954-02

Recommended Standards

Description	Unit	Cat. No.
Silica Standard Solution, 50-mg/L	200 mL	1117-29
Silica Standard Solution, 1000-mg/L	500 mL	194-49

Optional Reagents and Apparatus

Description	Cat. No.
Sodium Bicarbonate, 454 grams	776-01
Sulfuric Acid 1.00 N, 100 mL	1270-32



FOR TECHNICAL ASSISTANCE, PRICE INFORMATION AND ORDERING:
In the U.S.A. – Call toll-free 800-227-4224
Outside the U.S.A. – Contact the HACH office or distributor serving you.
On the Worldwide Web – www.hach.com; E-mail – techhelp@hach.com

HACH COMPANY
WORLD HEADQUARTERS
Telephone: (970) 669-3050
FAX: (970) 669-2932

Method 8120

Colorimetric Method

Powder Pillows

(0.005 to 0.700 mg/L)

Scope and Application: For water and wastewater.



Test Preparation

Before starting the test:

Digestion is required for samples with interferences. See [Digestion on page 5](#).

For more accurate results, determine a reagent blank value for each new lot of reagent. Follow the procedure using deionized water instead of the sample. Subtract the reagent blank value from the final results or perform a reagent blank adjust.

The graduated cylinder must be completely dry before beginning the test. If the Silver 1 Powder becomes moist, it will not dissolve completely, which will inhibit color development.

The sample pH for this test must be between 9 and 10. Do not use a pH meter to adjust the sample pH as it will cause contamination. See [Digestion on page 5](#) for the procedure to adjust pH.

Generate a blank for each sample.

Collect the following items:

Quantity

Silver 1 Reagent Powder Pillow	1
Silver 2 Reagent Powder Pillow	1
Sodium Thiosulfate Powder Pillow	1
Clippers	1
Cylinder, graduated, 50-mL	1
Cylinder, graduated mixing, 50-mL	1
Sample Cells, 10-mL square, 1-inch	2

Note: Reorder information for consumables and replacement items is on [page 7](#).

Powder Pillows

Method 8120



1. Press
STORED PROGRAMS.

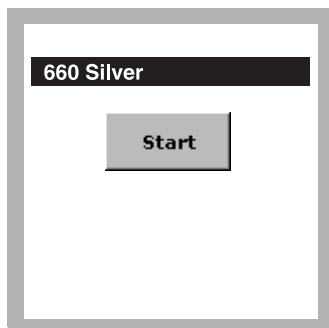

2. Select the test.

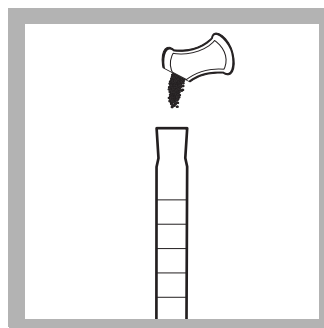

3. Add the contents of one Silver 1 Powder Pillow to a dry 50-mL graduated mixing cylinder.

If the Silver 1 Powder becomes wet at this point, the powder will not dissolve completely, which will inhibit color development.

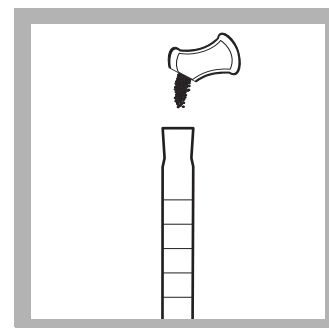

4. Add the contents of one Silver 2 Reagent Solution Pillow to the cylinder. Swirl to completely wet the powder.

If clumps of dry powder are present when the sample is poured in, the powder will not dissolve completely, which will inhibit color development.

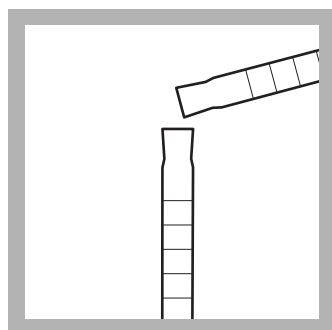

5. Use a 50-mL graduated cylinder to add 50 mL of sample to the 50-mL graduated mixing cylinder. Stopper and invert repeatedly for one minute.

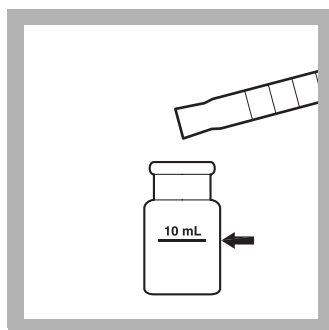

6. **Prepared Sample:** Fill a square sample cell to the 10-mL mark with the mixture.

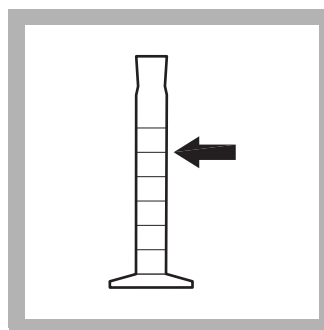

7. **Blank Preparation:** Discard all but 25-mL of the sample from step 5.

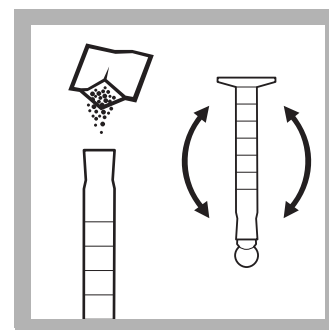

8. Add the contents of one Sodium Thiosulfate Reagent Powder Pillow to the remaining 25-mL of sample. Stopper and invert to mix.

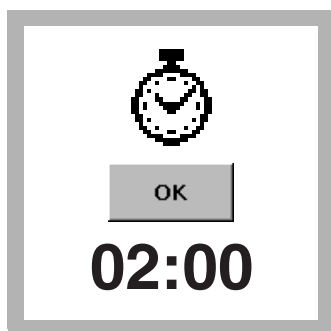
**9. Press TIMER>OK.**

A two-minute reaction period will begin.

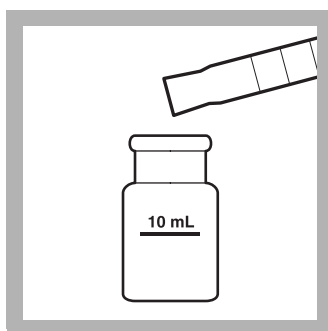

10. Pour 10 mL of the blank into a second square sample cell.

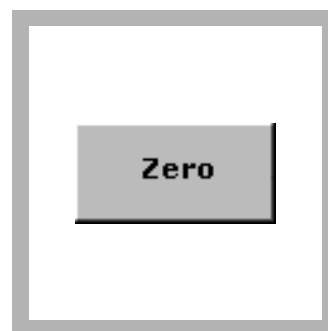

11. When the timer expires, insert the blank into the cell holder with the fill line facing right.

**12. Press ZERO.**

The display will show:
0.000 mg/L Ag



13. insert the prepared sample into the cell holder with the fill line facing right.

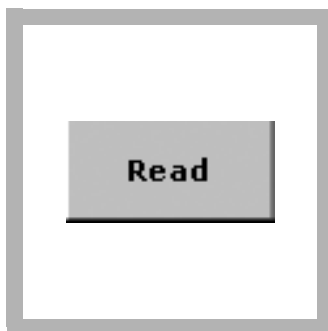

14. Press READ.
Results are in mg/L Ag.

Interferences

Interference studies were conducted by preparing a known silver solution (about 0.4 mg/L) and the potential interfering ion. The ion was said to interfere when the resulting concentration changed by $\pm 10\%$.

Table 1 Interfering Substances and Levels

Interfering Substance	Interference Levels
Aluminum	Negative interference above 30 mg/L
Ammonia	Negative interference above 750 mg/L
Cadmium	Negative interference above 15 mg/L
Calcium	Positive interference above 600 mg/L
Chloride	Negative interference above 19 mg/L
Chromium ⁶⁺	Negative interference above 90 mg/L
Copper	Negative interference above 7 mg/L
Iron	Negative interference above 30 mg/L
Lead	Negative interference above 13 mg/L
Manganese	Negative interference above 19 mg/L
Magnesium	Positive interference above 2000 mg/L

Table 1 Interfering Substances and Levels (continued)

Interfering Substance	Interference Levels
Mercury	Positive interference above 2 mg/L
Nickel	Negative interference above 19 mg/L
Zinc	Negative interference above 70 mg/L

Sample Collection, Storage, and Preservation

Collect samples in acid-cleaned glass or plastic bottles. Using pH paper, adjust the pH to 2 or less with concentrated Nitric Acid* (about 2 mL/liter). Store preserved samples at room temperature for up to 6 months. If the sample contains particulates or only dissolved metal content is being determined, filter through a 0.45 µm filter at collection. After filtration, adjust the pH to 2 or less as described above for storage.

Before analysis, adjust the pH to 9–10 with 5.0 N Sodium Hydroxide*. (See steps 13–14 of [Digestion on page 5](#).) Do not use a pH meter because of silver contamination from the electrode.

Accuracy Check

Standard Additions Method (Sample Spike)

1. After reading test results, leave the sample cell (unspiked sample) in the instrument.
2. Press **OPTIONS>MORE**. Press **STANDARD ADDITIONS**. A summary of the standard additions procedure will appear.
3. Press **OK** to accept the default values for standard concentration, sample volume, and spike volumes. Press **EDIT** to change these values. After values are accepted, the unspiked sample reading will appear in the top row. See the user manual for more information.
4. Add 5.00 mL of 1000 mg/L Silver Standard Solution to a 100-mL volumetric Class A flask. Dilute to volume with deionized water. This is a 50.0 mg/L standard solution.
5. Prepare three sample spikes. Fill three mixing cylinders* with 50-mL of sample. Use the TenSette® Pipet to add 0.1 mL, 0.2 mL, and 0.3 mL of standard, respectively, to each sample and mix thoroughly.
6. Analyze each sample spike as described in the procedure above, starting with the 0.1 mL sample spike. Accept each standard additions reading by pressing **READ**. Each addition should reflect approximately 100% recovery.
7. After completing the sequence, press **GRAPH** to view the best-fit line through the standard additions data points, accounting for matrix interferences. Press **IDEAL LINE** to view the relationship between the sample spikes and the “Ideal Line” of 100% recovery.

Standard Solution Method

Prepare a 0.5 mg/L silver standard solution as follows:

1. Pipet 0.50 mL of Silver Standard Solution, 1000 mg/L, into a 1000-mL volumetric flask using a Class A volumetric pipet. Dilute to the mark with deionized water. Prepare this solution daily. Perform the silver procedure as described above.

* See [Optional Reagents and Apparatus on page 7](#).

2. To adjust the calibration curve using the reading obtained with the 0.5-mg/L silver standard solution, press **OPTIONS>MORE** on the current program menu. Press **STANDARD ADJUST**.
3. Press **ON**. Press **OK** to accept the displayed concentration. If an alternate concentration is used, press the number to enter the actual concentration. Press **OK**. Press **ADJUST**.

Digestion

This digestion is for samples containing organic matter, thiosulfate or cyanide. Possible sources for these compounds are wastewater, silver electroplating baths and silver strike solutions. Digestion should be done with a Digesdahl Digestion Apparatus.

DANGER

Perform this digestion under a fume hood. Poisonous hydrogen cyanide gas may be generated.



CAUTION

Always wear safety glasses and use a safety shield, or operate the Digesdahl within a closed fume hood. Follow the additional safety precautions in the Digesdahl Digestion Apparatus Manual.

1. Add an appropriate size sample to the 100-mL digestion flask for use with the Digesdahl. Add several boiling chips to prevent bumping.

Note: Appropriate sample size is determined experimentally. The final sample concentration (after dilution to 100 mL) should be 0–0.6 mg/L. Larger dilutions may be necessary for electroplating baths and silver strike solutions. Do not exceed the maximum sample volume of 25 mL. Several 25-mL aliquots may be digested in succession to concentrate a very dilute sample.

2. Turn on the water aspirator and make sure there is suction in the fractionating head.
3. Add 3 mL of concentrated sulfuric acid to the sample in the volumetric flask. Immediately place the head on the digestion flask. Never use less than 3 mL of acid.
4. Place the digestion flask on the heater. Turn the temperature dial to 440 °C (825 °F).
5. After the sample begins to char or the sulfuric acid reflux line becomes visible, wait 3–5 minutes.
6. Visually confirm the presence of acid in the flask before adding hydrogen peroxide!
7. Add 10 mL of 50% hydrogen peroxide to the sample via the capillary funnel in the fractionating head.
8. After the hydrogen peroxide has boiled off, heat the sample until heavy white sulfuric acid fumes are present. Continue heating and reduce the sample volume to near dryness. Do not let the sample go completely dry at any time.

Note: If the sample evaporates, turn the Digesdahl off and cool completely. Add water to flask before handling. Repeat digestion from the beginning.

Note: If only thiosulfate is present in the sample, proceed to step 1 of the Colorimetric procedure.

9. Add another 3 mL of sulfuric acid via the capillary funnel.

10. Add another 5 mL of hydrogen peroxide. Check the solution for digestion completion. If digestion is not complete, continue adding hydrogen peroxide in 5 to 10 mL portions. Several portions may be necessary.

Note: Digestion is complete when the digestate is colorless or the color of the digestate does not change upon addition of hydrogen peroxide. Also, a completely digested sample will not foam.

11. After digestion is complete and all the hydrogen peroxide is boiled off, reduce the volume of the digestate to near dryness. Do not allow the sample to become completely dry. Remove the flask from the heater. Cool to room temperature.

12. Slowly add about 25 mL of deionized water to the cooled flask.

13. Add 2 drops of 1 g/L Phenolphthalein Indicator Solution. Add 2 drops of 1 g/L Thymolphthalein Indicator Solution.

14. Using sodium hydroxide, adjust the pH of the solution to 9–10. The solution will be pink in this pH range.

Note: A purple color indicates a pH greater than 10. If this occurs, add a drop of sulfuric acid and 2 drops of each indicator; repeat pH adjustment. Initially, use 50% sodium hydroxide, then 1 N sodium hydroxide as the end point is approached.

15. Filter turbid digestates. Quantitatively transfer the filtrate (or unfiltered sample) to a clean 100-mL volumetric flask. Dilute to the mark with deionized water. The sample is ready for analysis.

Summary of Method

Silver ions in basic solution react with cadion 2B to form a green to brown to red-purple complex. The sodium thiosulfate acts as a decolorizing agent for the blank. The Silver 1 and Silver 2 reagents contain the buffer, indicator, and masking agents. Organic extractions are not necessary and this method does not have as many interferences as the traditional dithizone method. Test results are measured at 560 nm.

Consumables and Replacement Items

Required Reagents

Description	Quantity/Test	Unit	Cat. No.
Silver Reagent Set (50 tests), includes:			22966-00
Silver 1 Reagent Powder Pillow	1	50/pkg	22935-66
Silver 2 Reagent Solution Pillow	1	50/pkg	22936-66
Sodium Thiosulfate Powder Pillow	1	50/pkg	22937-66

Required Apparatus

Description	Quantity/Test	Unit	Cat. No.
Clippers	1	each	968-00
Cylinder, graduated, 50-mL	1	each	21179-41
Cylinder, graduated, mixing, 50-mL	1	each	1896-41
Sample Cells, 1-inch square, 10 mL, matched pair	2	2/pkg	24954-02

Digestion Reagents and Apparatus

Description	Unit	Cat. No.
Hydrogen Peroxide, 50%	490 mL	21196-49
Phenolphthalein Indicator Solution, 1 g/L	15 mL SCDB	1897-36
Sodium Hydroxide Solution, 50%	500 mL	2180-49
Sodium Hydroxide Solution, 1.00 N	100 mL MDB	1045-32
Sulfuric Acid, ACS, concentrated	2.5 L	979-09
Thymolphthalein Indicator Solution, 1 g/L	15 mL SCDB	21853-36
Water, deionized	4 L	272-56
Boiling Chips, silicon carbide	500 g	20557-34
Digesdahl Digestion Apparatus, 115 V ac, 50/60 Hz	each	23130-20
Digesdahl Digestion Apparatus, 230 V ac, 50/60 Hz	each	23130-21
Safety Shield, for Digesdahl	each	50030-00

Recommended Standards

Description	Unit	Cat. No.
Silver Standard Solution, 1000 mg/L Ag	100 mL	14613-42
Water, deionized	4 L	272-56

Optional Reagents and Apparatus

Description	Unit	Cat. No.
Cylinder, mixing	50 mL	1896-41
Nitric Acid, concentrated ACS	500 mL	152-49
Sodium Hydroxide, 5.0 N	100 mL	2450-32



FOR TECHNICAL ASSISTANCE, PRICE INFORMATION AND ORDERING:

In the U.S.A. – Call toll-free 800-227-4224
Outside the U.S.A. – Contact the HACH office or distributor serving you.
On the Worldwide Web – www.hach.com; E-mail – techhelp@hach.com

HACH COMPANY
WORLD HEADQUARTERS
Telephone: (970) 669-3050
FAX: (970) 669-2932

★ Method 8051

SulfaVer 4 Method¹

Powder Pillows or AccuVac[®] Ampuls

(2 to 70 mg/L)

Scope and Application: For water, wastewater, and seawater; USEPA accepted for reporting wastewater analyses

¹ Adapted from *Standard Methods for the Examination of Water and Wastewater*. Procedure is equivalent to USEPA method 375.4 for wastewater.



Test Preparation

Before starting the test:

Adjust the standard curve for each new lot of reagent ([Standard Solutions on page 4](#)).

For best results, perform a new calibration for each lot of reagent ([Calibration Standard Preparation on page 5](#)).

For more accurate results, determine a reagent blank value for each new lot of reagent. Follow the procedure using deionized water in place of the sample. Subtract the reagent blank value from the final results or perform a reagent blank adjust.

Filter highly colored or turbid samples using filter paper¹ and a funnel¹. Use this sample in step 3 and 6. Undissolved reagent powder that has settled does not affect accuracy.

SulfaVer[®] 4 contains barium chloride. The final solution will contain barium chloride (D005) at a concentration regulated as a hazardous waste by the Federal RCRA. Refer to a current MSDS for safe handling and disposal instructions.

Collect the following items:

Quantity

	Quantity
Powder Pillow Test:	
SulfaVer [®] 4 Reagent Powder Pillows	1
Sample Cells, 1-inch square, 10-mL	2
AccuVac Test:	
SulfaVer [®] 4 Reagent AccuVac [®] Ampuls	1
Beaker, 50-mL	1
Sample Cell, 10-mL round, with cap	1
Stopper for 18 mm Tube	1

Note: Reorder information for consumables and replacement items is on [page 5](#).

¹ See [Optional Reagents and Apparatus on page 5](#).

Powder Pillows

Method 8051

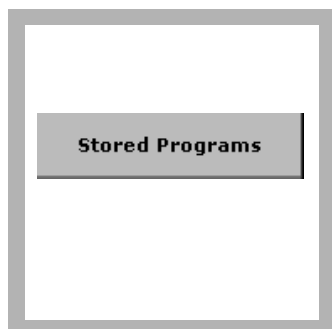

1. Press **STORED PROGRAMS**.

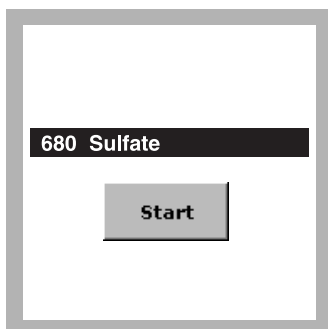

2. Select the test.

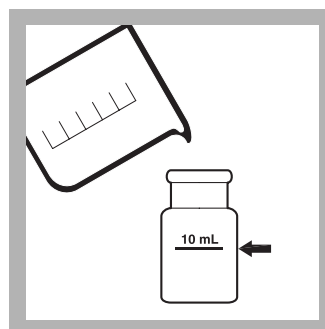

3. Fill a square sample cell with 10 mL of sample.

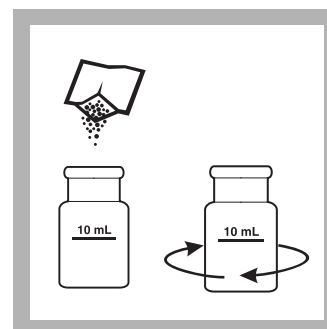

4. **Prepared Sample:** Add the contents of one SulfaVer 4 Reagent Powder Pillow to the sample cell. Swirl vigorously to dissolve powder.

White turbidity will form if sulfate is present.

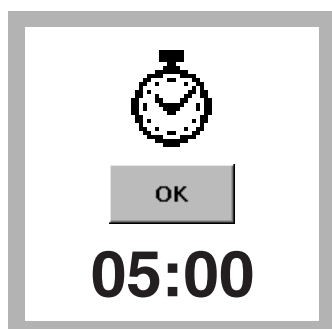

5. Press **TIMER>OK**.
A five-minute reaction period will begin. Do not disturb the cell during this time.

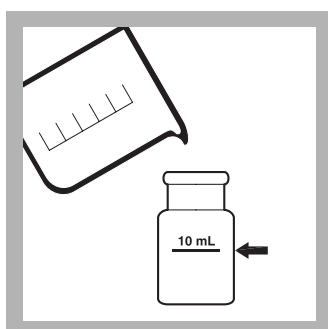

6. **Blank Preparation:** Fill a second square sample cell with 10 mL of sample.

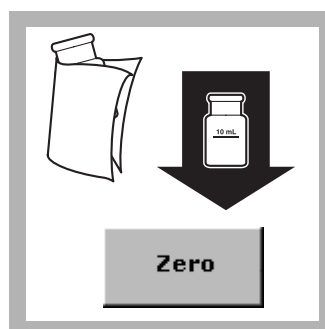

7. When the timer expires, insert the blank into the cell holder with the fill line facing right.
Press **ZERO**.

The display will show:
0 mg/L SO₄²⁻

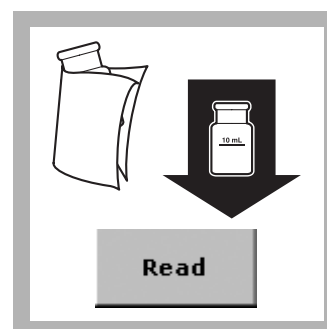

8. Within five minutes after the timer expires, insert the prepared sample into the cell holder with the fill line facing right.
Press **READ**. Results are in mg/L SO₄²⁻.
Clean sample cells with a soap and brush.

AccuVac Ampul

Method 8051

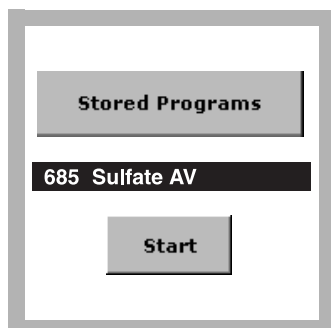

1. Select the test.

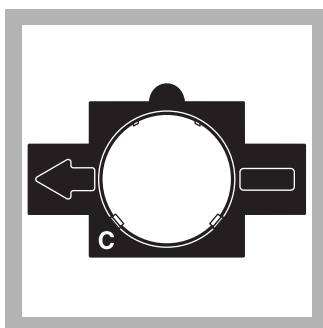

2. Insert Adapter C.



3. **Prepared Sample:**
Collect at least 40 mL of sample in a 50-mL beaker.

Fill a SulfaVer 4 Sulfate AccuVac Ampul with sample. Keep the tip immersed until the Ampul fills completely.

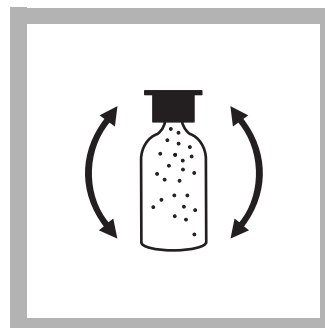

4. Quickly invert the Ampul several times to mix.

White turbidity will form if sulfate is present.

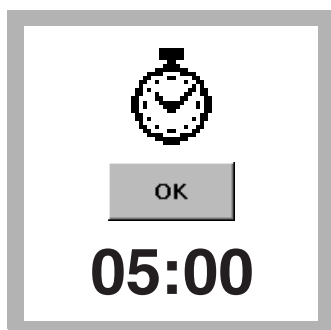

5. Press **TIMER>OK**.

A five-minute reaction period will begin. Do not disturb the cell during this time.

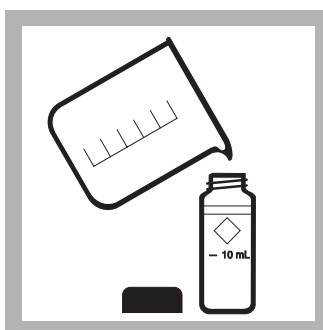

6. Fill a clean sample cell with 10 mL of sample.

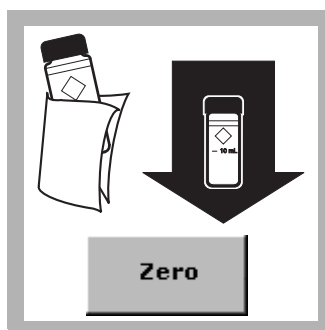

7. When the timer expires, insert the blank into the cell holder.

Press **ZERO**.

The display will show:
0 mg/L SO_4^{2-}



8. Within five minutes after the timer expires, insert the Ampul into the cell holder.

Press **READ**. Results are in mg/L SO_4^{2-} .

Interferences

Table 1 Interfering Substances and Levels

Interfering Substance	Interference Levels and Treatments
Calcium	Greater than 20,000 mg/L as CaCO_3
Chloride	Greater than 40,000 mg/L as Cl^-
Magnesium	Greater than 10,000 mg/L as CaCO_3
Silica	Greater than 500 mg/L as SiO_2

Sample Collection, Storage, and Preservation

Collect samples in clean plastic or glass bottles. Samples may be stored up to 7 days by cooling to 4 °C (39 °F) or lower. Warm to room temperature before analysis.

Accuracy Check

Standard Additions Method (Sample Spike)

1. After reading test results, leave the sample cell (unspiked sample) in the instrument.
2. Press **OPTIONS>MORE**. Press **STANDARD ADDITIONS**. A summary of the standard additions procedure will appear.
3. Press **OK** to accept the default values for standard concentration, sample volume, and spike volumes. Press **EDIT** to change these values. After values are accepted, the unspiked sample reading will appear in the top row. See the user manual for more information.
4. Snap the neck off a Sulfate Ampule Standard, 2500-mg/L sulfate.
5. Prepare three sample spikes. Fill three mixing cylinders* with 25 mL of sample. Use the TenSette® Pipet to add 0.1 mL, 0.2 mL, and 0.3 mL of standard, respectively, to each sample and mix thoroughly.
6. Transfer 10 mL of each sample spike to a clean sample cell and analyze each sample spike as described in the procedure above, starting with the 0.1 mL sample spike. Accept each standard additions reading by pressing **READ**. Each addition should reflect approximately 100% recovery.

Note: For AccuVac® Ampuls, fill three Mixing Cylinders* with 50 mL of sample and spike with 0.2 mL, 0.4 mL, and 0.6 mL of standard. Transfer 40 mL from each of the three mixing cylinders to three 50-mL Beakers†. Analyze each standard addition sample as described in the procedure above. Accept each standard additions reading by pressing **READ**. Each addition should reflect approximately 100% recovery.

7. After completing the sequence, press **GRAPH** to view the best-fit line through the standard additions data points, accounting for the matrix interferences. Press **IDEAL LINE** to view the relationship between the sample spikes and the “Ideal Line” of 100% recovery.

Standard Solutions

Prepare a 70-mg/L sulfate standard solution as follows:

1. Using Class A glassware, Pipet 7 mL of Sulfate Standard Solution, 1000-mg/L, into a 100-mL volumetric flask. Dilute to the mark with deionized water. Prepare this solution daily. Perform the SulfaVer procedure as described above.
2. To adjust the calibration curve using the reading obtained with the standard solution, press **OPTIONS>MORE** on the current program menu. Press **STANDARD ADJUST**.
3. Press **ON**. Press **ADJUST** to accept the displayed concentration. If an alternate concentration is used, press the number in the box to enter the actual concentration, then press **OK**. Press **ADJUST**.

* See [Optional Reagents and Apparatus on page 5](#).

† See [Required Apparatus \(AccuVac\) on page 5](#).

Calibration Standard Preparation

To perform a sulfate calibration using the SulfaVer method, use Class A glassware to prepare calibration standards containing 10, 20, 30, 40, 50, 60, and 70 mg/L SO_4^{2-} as follows:

1. Into seven different 100-mL Class A volumetric flasks, pipet 1, 2, 3, 4, 5, 6, and 7 mL of the 1000-mg/L Sulfate Standard Solution.
2. Dilute to the mark with deionized water. Mix thoroughly.
3. Using the SulfaVer method and the calibration procedure described in the User Programs section of the user manual, generate a calibration curve from the calibration standards prepared above.

Summary of Method

Sulfate ions in the sample react with barium in the SulfaVer 4 and form a precipitate of barium sulfate. The amount of turbidity formed is proportional to the sulfate concentration. Test results are measured at 450 nm.

Consumables and Replacement Items**Required Reagents**

Description	Quantity/Test	Unit	Cat. No.
SulfaVer® 4 Reagent Powder Pillows	1	100/pkg	21067-69
OR			
SulfaVer® 4 Sulfate Reagent AccuVac® Ampuls	1	25/pkg	25090-25

Required Apparatus (Powder Pillows)

Description	Quantity/Test	Unit	Cat. No.
Sample Cells, 1-inch square, 10 mL, matched pair	2	2/pkg	24954-02

Required Apparatus (AccuVac)

Description	Quantity/Test	Unit	Cat. No.
Adapter, 1-inch round, for AccuVac Ampuls	1	each	LZV584
Beaker, 50-mL	1	each	500-41H
Sample Cell, 10-mL, with cap	1	each	21228-00
Stopper for 18 mm Tube	1/test	6/pkg	1731-06

Recommended Standards

Description	Unit	Cat. No.
Sulfate Standard Solution, 1000-mg/L	500 mL	21757-49
Sulfate Standard Solution, 2500-mg/L, 10-mL Ampules	16/pkg	14252-10
Standard, Drinking Water, Mixed Parameter, Inorganic for F^- , NO_3^- , PO_4^{3-} , SO_4^{2-}	500 mL	28330-49

Optional Reagents and Apparatus

Description	Unit	Cat. No.
Cylinder, mixing, 25-mL	each	1896-40
Cylinder, mixing, 50 mL	each	1896-41
Stopper for 18 mm Tube	25/pkg	



FOR TECHNICAL ASSISTANCE, PRICE INFORMATION AND ORDERING:

In the U.S.A. – Call toll-free 800-227-4224
Outside the U.S.A. – Contact the HACH office or distributor serving you.
On the Worldwide Web – www.hach.com; E-mail – techhelp@hach.com

HACH COMPANY
WORLD HEADQUARTERS
Telephone: (970) 669-3050
FAX: (970) 669-2932

Scope and Application: For testing total sulfides, H₂S, HS⁻, and certain metal sulfides in groundwater, wastewater brines, and seawater; USEPA Approved for reporting wastewater analysis²

¹ Adapted from *Standard Methods for the Examination of Water and Wastewater*.

² Procedure is equivalent to USEPA method 376.2 and Standard Method 4500-S²⁻ D for wastewater.



Test Preparation

Before starting the test:

Analyze samples immediately. Do not preserve for later analysis.

Avoid excessive agitation of samples to minimize sulfide loss.

Some sulfide loss may occur if dilution is necessary.

Sulfide 2 reagent contains potassium dichromate. The final solution will contain hexavalent chromium (D007) at a concentration regulated as a hazardous waste by Federal RCRA. Refer to the current MSDS for safe handling and disposal instructions.

Collect the following items:

Quantity

Sulfide 1 Reagent	2 mL
Sulfide 2 Reagent	2 mL
Water, deionized	25 mL
Pipet, serological, 10-mL	1
Pipet Filler, safety bulb	1
Sample Cells, 1-inch square, 10 mL, matched pair	2
Stopper for 18-mm tube	2

Note: Reorder information for consumables and replacement items is on page 3.

Method 8131



1. Press **STORED PROGRAMS**.

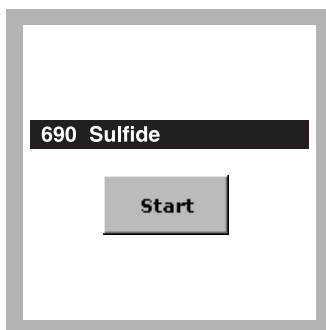

2. Select the test.

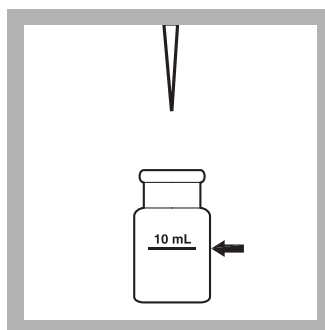

3. **Prepared Sample:** Avoiding excess agitation of the sample, use a pipet add 10 mL of sample to a square sample cell.

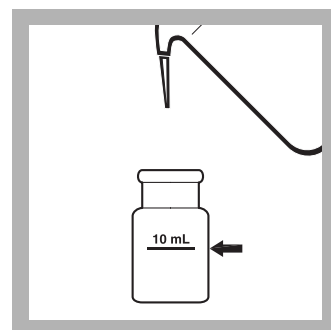

4. **Blank Preparation:** Measure 10 mL of deionized water into a second square sample cell.

Sulfide (5 to 800 µg/L)

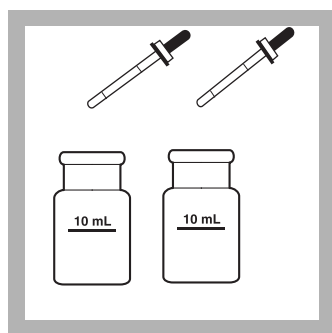

5. Use the calibrated dropper to add 0.5 mL of Sulfide 1 Reagent to each cell. Swirl to mix.

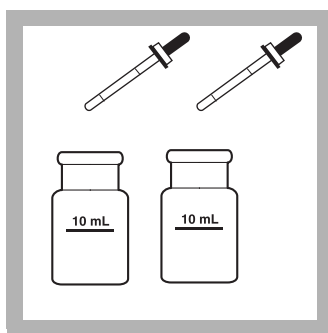

6. Use the calibrated dropper to add 0.5 mL of Sulfide 2 Reagent to each cell.

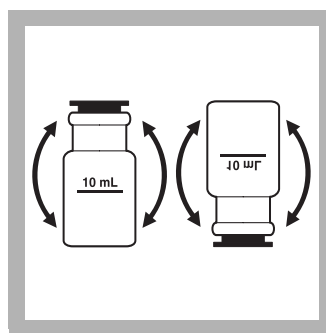

7. Cap the cell and immediately invert to mix. A pink color will develop, then the solution will turn blue if sulfide is present.

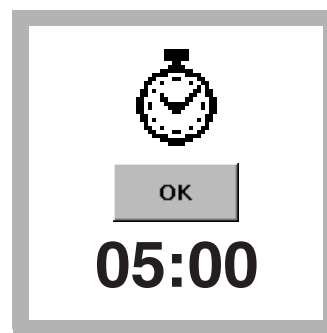

8. Press **TIMER>OK**. A five-minute reaction period will begin.



9. When the timer expires, wipe the blank and insert it into the cell holder with the fill line facing right.

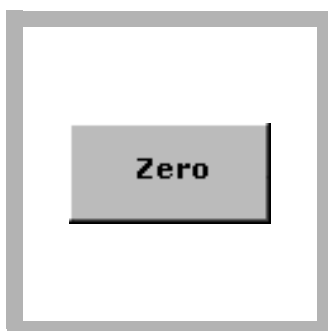

10. Press **ZERO**. The display will show:
0 µg/L S²⁻



11. Wipe the prepared sample and insert it into the cell holder with the fill line facing right.



12. Press **READ**. Results are in µg/L S²⁻.

Determining Soluble Sulfides

Determine soluble sulfides by centrifuging the sample in completely filled, capped tubes and analyzing the supernatant. Insoluble sulfides are then estimated by subtracting the soluble sulfide concentration from the total sulfide result.

Interferences

Table 1 Interfering Substances and Levels

Interfering Substance	Interference Levels and Treatments
Strong reducing substances (sulfite, thiosulfate and hydrosulfite)	Interferes by reducing the blue color or preventing its development.
Sulfide, high levels	High concentrations of sulfide may inhibit full color development and require sample dilution. Some sulfide loss may occur when the sample is diluted.

Table 1 Interfering Substances and Levels (continued)

Interfering Substance	Interference Levels and Treatments
Turbidity	<p>For turbid samples, prepare a sulfide-free blank as follows. Use it in place of the deionized water blank in the procedure.</p> <ol style="list-style-type: none"> 1. Measure 25 mL of sample into a 50-mL Erlenmeyer flask. 2. Add Bromine Water dropwise with constant swirling until a permanent yellow color just appears. 3. Add Phenol Solution dropwise until the yellow color just disappears. Use this solution to replace the deionized water in step 4 of the procedure.

Sample Collection, Storage, and Preservation

Collect samples in clean plastic or glass bottles. Fill completely and cap tightly. Avoid excessive agitation or prolonged exposure to air. Analyze samples immediately.

Summary of Method

Hydrogen sulfide and acid-soluble metal sulfides react with N,N-dimethyl-p-phenylenediamine sulfate to form methylene blue. The intensity of the blue color is proportional to the sulfide concentration. High sulfide levels in oil field waters may be determined after proper dilution. Test results are measured at 665 nm.

Consumables and Replacement Items

Required Reagents

Description	Quantity/Test	Unit	Cat. No.
Sulfide Reagent Set (100 tests), includes:	—	—	22445-00
(2) Sulfide 1 Reagent	2 mL	100 mL MDB	1816-32
(2) Sulfide 2 Reagent	2 mL	100 mL MDB	1817-32
Water, deionized	25 mL	4 liters	272-56

Required Apparatus

Description	Quantity/Test	Unit	Cat. No.
Pipet, serological, 10-mL	1	each	532-38
Pipet Filler, safety bulb	1	each	14651-00
Sample Cells, 1-inch square, 10 mL, matched pair	2	2/pkg	24954-02
Stopper, for 18-mm Tube	2	6/pkg	1731-06

Optional Reagents and Apparatus

Description	Unit	Cat. No.
Bromine Water	29 mL	2211-20
Phenol Solution	29 mL	2112-20
Stopper, for 18-mm Tube	25/pkg	1731-25



FOR TECHNICAL ASSISTANCE, PRICE INFORMATION AND ORDERING:

In the U.S.A. – Call toll-free 800-227-4224
Outside the U.S.A. – Contact the HACH office or distributor serving you.
On the Worldwide Web – www.hach.com; E-mail – techhelp@hach.com

HACH COMPANY
WORLD HEADQUARTERS
Telephone: (970) 669-3050
FAX: (970) 669-2932

Sulfite

Colorimetric Method¹

(0.10 to 5.00 mg/L)

Scope and Application: For boiler water, foodstuffs

¹ Reagent sets for this method are only available in Europe.



Test Preparation

Before starting the test:

Samples must be analyzed immediately.

Sample and Reagent temperature must be between 15–25 °C (59–77 °F).

Adjust the sample pH between 3–10.

Collect the following items:

Quantity

Sulfite Colorimetric Reagent Set:	
Sulfite Reagent A	5 drops
Sulfite Reagent B	2 drops
Water, deionized	varies
Pipet, 10-mL serological	1
Pipet Filler, safety bulb	1
Sample Cells, 1-inch square, 10 mL, matched pair	2

Note: Reorder information for consumables and replacement items is on page 3.

Colorimetric Method



1. Press **STORED PROGRAMS**.

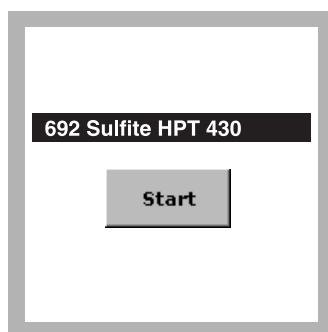

2. Select the test.

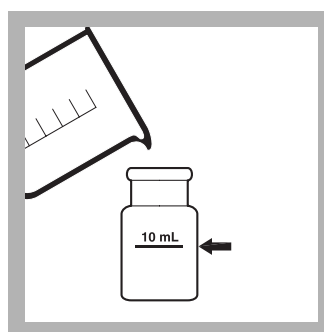

3. **Blank Preparation:**
Fill a clean square sample cell with 10 mL of sample.

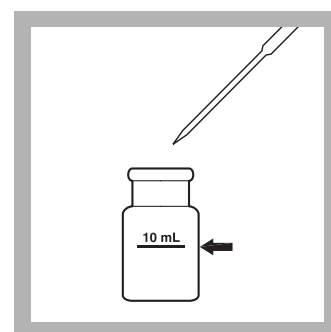

4. **Prepared Sample:**
Pipet 10 mL of sample into a second clean square sample cell.

Sulfite (0.10 to 5.00 mg/L)

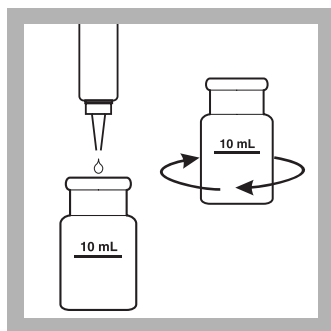

5. Add 5 drops of Sulfite Reagent A (HPT 430 A) to the prepared sample. Swirl to mix.

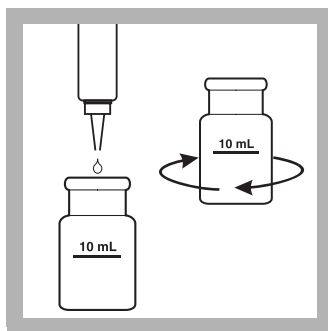

6. Add 2 drops of Sulfite Reagent B (HPT 430 B) to the prepared sample. Swirl to mix.

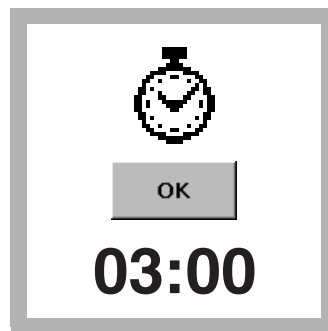

7. Press **TIMER>OK**.
A 3-minute reaction period will begin. Do not disturb the cell during this time.



8. Wipe the blank and insert it into the cell holder with the fill line facing right.

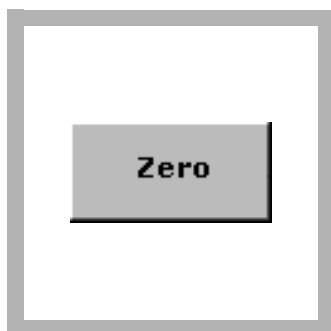

9. Press **ZERO**.
The display will show:
0.00 mg/L SO_3^{2-}



10. When the timer expires, wipe the prepared sample and insert it into the cell holder with the fill line facing right.

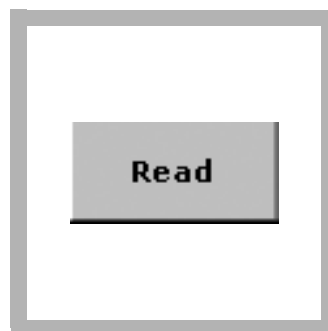

11. Press **READ**.
Results are in mg/L SO_3^{2-} .

Interferences

Table 1 Interfering Substances and Levels

Interfering Substance	Interference Levels
Sulfide	Greater than 5 mg/L

Sample Collection, Storage, and Preservation

Collect samples in clean plastic or glass bottles. Samples may be stored up to 7 days by cooling to 4 °C (39 °F) or lower. Warm to 15–25 °C (59–77 °F) before analysis.

Summary of Method

The reagents react with sulfite to form a yellow complex. The samples are measured at 435 nm.

Consumables and Replacement Items

Required Reagents

Description	Quantity/Test	Unit	Cat. No.
Sulfite Colorimetric Reagent Set, includes:	—	100/pkg	HPT430
Sulfite Reagent A ¹	5 drops	28 mL	—
Sulfite Reagent B ¹	2 drops	8.7 mL	—

¹ Not available separately

Required Apparatus

Description	Quantity/Test	Unit	Cat. No.
Pipet, 10-mL serological	1	each	532-38
Pipet Filler, safety bulb	1	each	14651-00
Sample Cells, 1-inch square, 10 mL, matched pair	2	2/pkg	24954-02



FOR TECHNICAL ASSISTANCE, PRICE INFORMATION AND ORDERING:

In the U.S.A. – Call toll-free 800-227-4224
Outside the U.S.A. – Contact the HACH office or distributor serving you.
On the Worldwide Web – www.hach.com; E-mail – techhelp@hach.com

HACH COMPANY
WORLD HEADQUARTERS
Telephone: (970) 669-3050
FAX: (970) 669-2932

Surfactants, Anionic (Detergents)

Method 8028

Crystal Violet Method¹
(0.002 to 0.275 mg/L as LAS)

Scope and Application: For water, wastewater, and seawater

¹ *Analytical Chemistry*, 38, 791 (1966).



Test Preparation

Before starting the test:

Use benzene only in a well-ventilated area.

Benzene (D018) solutions are regulated as hazardous waste by the Federal RCRA. Do not pour these materials down the drain. Collect water saturated with benzene and benzene solutions for disposal with laboratory solvent wastes. Refer to the current MSDS for safe handling and disposal instructions.

To prevent water droplets from forming in the sample cells, use only dry sample cells and discard the first few mL of benzene. Additionally, it helps to transfer the liquid from the funnel to a sample cell, let it sit for a few seconds, and decant to a second cell for reading.

Excessive agitation may cause an emulsion to form, which in turn makes the phases separate more slowly. Should this occur, remove most of the water layer, then gently agitate the contents of the funnel with a clean Teflon[®]-coated rod or other such inert tool.

Spilled reagent will affect test accuracy and is hazardous to the skin and other materials.

Acetone may be used to clean benzene from glassware.

For more accurate results, determine a reagent blank value for each new lot of reagent. Follow the procedure using deionized water in place of the sample. Subtract the reagent blank value from the final results or perform a reagent blank adjust.

Spilled reagent will affect test accuracy and is hazardous to the skin and other materials.

In bright light conditions (e.g. direct sunlight) it may be necessary to close the cell compartment with the protective cover during measurements.

Collect the following items:

Quantity

Benzene, ACS	55 mL
Buffer Solution, sulfate-type	10 mL
Detergent Reagent Powder Pillows	1 pillow
Clippers, for opening powder pillows	1
Cylinder, graduated, 25-mL	1
Cylinder, graduated, 50-mL	1
Cylinder, graduated, 500-mL	1
Funnel, separatory, 500-mL	1
Sample Cells, 10, 25 mL stoppered	2
Support Ring, 4-inch	1
Support, Ring Stand, 5 x 8 inch base	1

Note: Reorder information for consumables and replacement items is on page 5.

Method 8028



1. Press **STORED PROGRAMS**.

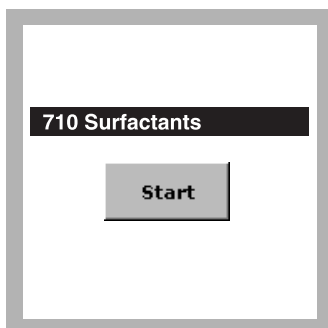

2. Select the test.

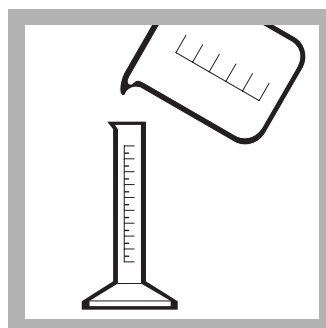

3. Fill a clean 500-mL graduated cylinder to the 300 mL mark with sample. Pour the sample into a clean 500-mL separatory funnel.

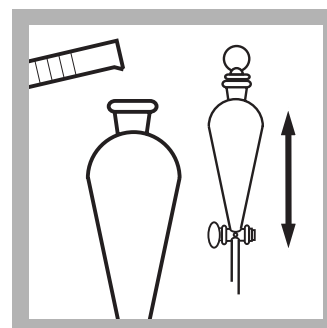

4. Add 10 mL of Sulfate Buffer Solution. Stopper the funnel. Shake the funnel for five seconds.

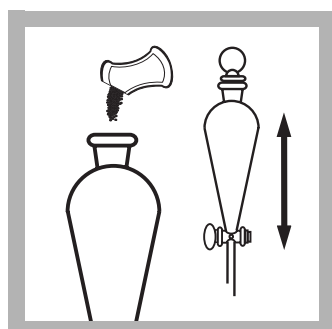

5. Add the contents of one Detergents Reagent Powder Pillow to the funnel. Stopper the funnel and shake until the powder dissolves completely.

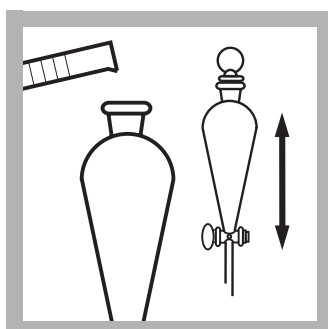

6. Add 30 mL of benzene to the funnel. Stopper the funnel and shake gently for one minute.

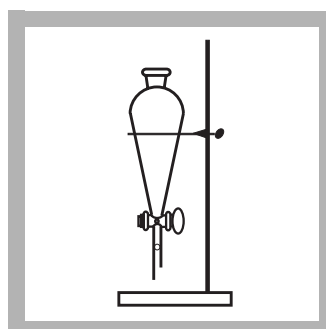

7. Place the separatory funnel in a support stand.



8. Press **TIMER>OK**. A 30-minute reaction period will begin.

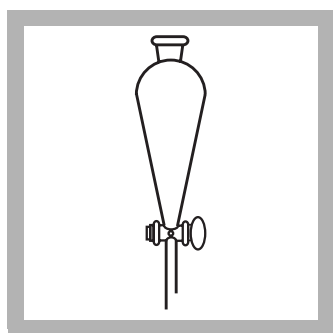

9. After the timer expires, remove the stopper and drain the bottom water layer. Discard this layer.

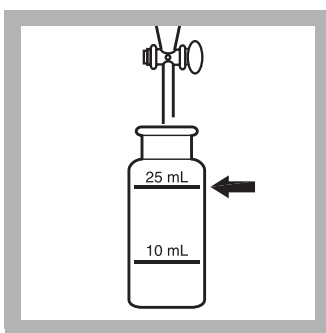

10. Prepared Sample: Drain the top benzene layer into a clean 25-mL sample cell.

Do not filter the benzene layer before color measurement. Filtration removes the blue color.

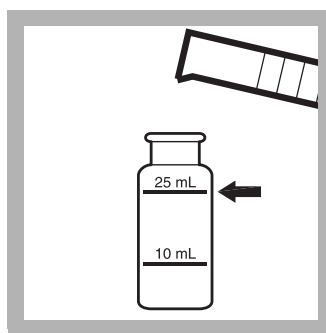

11. Blank Preparation: Fill another sample cell to the 25-mL mark with pure benzene.



12. Insert the blank into the cell holder with the fill line facing right.

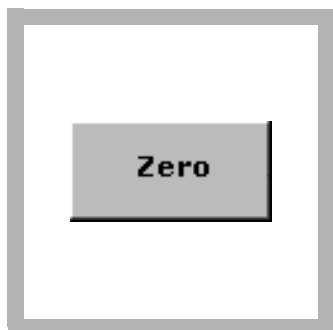

13. Press **ZERO**.
The display will show:
0.000 mg/L LAS



14. Insert the prepared sample into the cell holder with the fill line facing right.

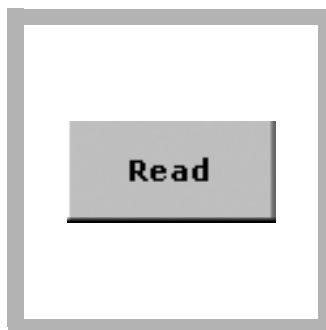

15. Press **READ**.
Results are in mg/L LAS.

Interferences

Table 1 Interfering Substances and Levels

Interfering Substance	Interference Levels and Treatments
Chloride	High amounts of chloride, such as those levels found in brines and seawater, will cause low results.
Perchlorate ions	Interferes at all levels.
Periodate ions	Interferes at all levels.

Sample Collection, Storage, and Preservation

Collect samples in clean plastic or glass bottles. Analyze samples as soon as possible, but they may be stored at least 24 hours by cooling to 4 °C (39 °F). Warm to room temperature before testing.

Accuracy Check

Standard Additions Method (Sample Spike)

1. After reading test results, leave the sample cell (unspiked sample) in the instrument. Verify that the units displayed are in mg/L.
2. Press **OPTIONS>MORE**. Press **STANDARD ADDITIONS**. A summary of the standard additions procedure will appear.
3. Press **OK** to accept the default values for standard concentration, sample volume, and spike volumes. Press **EDIT** to change these values. After values are accepted, the unspiked sample reading will appear in the top row. See the user manual for more information.
4. Snap the neck off a Detergent Voluette® Ampule Standard, 60-mg/L LAS.
5. Prepare three sample spikes. Fill three beakers with 300 mL of sample. Use the TenSette® Pipet to add 0.1 mL, 0.2 mL, and 0.3 mL of standard, respectively, to each sample and mix thoroughly.
6. Analyze each sample spike as described in the procedure above, starting with the 0.1 mL sample spike. Accept each standard additions reading by pressing **READ**. Each addition should reflect approximately 100% recovery.
7. After completing the sequence, press **GRAPH** to view the best-fit line through the standard additions data points, accounting for matrix interferences. Press **IDEAL LINE** to view the relationship between the sample spikes and the “Ideal Line” of 100% recovery.

Standard Solution Method

Prepare a 0.180-mg/L LAS standard solution as follows:

1. Pipet 3.0 mL of Detergent Standard, 60-mg/L as LAS, into a 1000-mL volumetric flask. Dilute to the mark with deionized water. Mix well. Prepare this solution daily. Perform the surfactants procedure as described above.
2. To adjust the calibration curve using the reading obtained with the standard solution, press **OPTIONS>MORE** on the current program menu. Press **STANDARD ADJUST**.
3. Press **ON**. Press **ADJUST** to accept the displayed concentration. If an alternate concentration is used, press the number in the box to enter the actual concentration, then press **OK**. Press **ADJUST**.

Summary of Method

Detergents, ABS (alkyl benzene sulfonate), or LAS (linear alkylate sulfonate) are determined by association with crystal violet dye and extraction of the ion-pair complex into benzene. Test results are measured at 605 nm.

Consumables and Replacement Items

Required Reagents

Description	Quantity/Test	Unit	Cat. No.
Detergents Reagent Set, includes:	—	—	24468-00
(1) Benzene, ACS	55 mL	4 liters	14440-17
(2) Buffer Solution, sulfate-type	10 mL	500 mL	452-49
(3) Detergent Reagent Powder Pillows	1 pillow	25/pkg	1008-68

Required Apparatus

Description	Quantity/Test	Unit	Cat. No.
Clippers, for opening powder pillows	1	each	968-00
Cylinder, graduated, 25-mL	1	each	508-40
Cylinder, graduated, 50-mL	1	each	508-41
Cylinder, graduated, 500-mL	1	each	508-49
Funnel, separatory, 500-mL	1	each	520-49
Sample Cells, 10, 25 mL stoppered	2	2/pkg	26126-02
Support Ring, 4-inch	1	each	580-01
Support, Ring Stand, 5 x 8 inch base	1	each	563-00

Recommended Standards

Description	Unit	Cat. No.
Detergent Standard Solution, 10-mL Voluette® Ampule, 60-mg/L LAS	16/pkg	14271-10

Optional Reagents and Apparatus

Description	Cat. No.
Acetone	14429-49
Beaker, 600 mL	500-52
Flask, volumetric, 1000 mL	14574-53
Pipet filler	14651-00
Pipet, TenSette®, 0.1 to 1.0 mL	19700-01
Pipet tips for TenSette Pipet 19700-01	21856-96
Pipet, volumetric, 3.00 mL	14515-03



FOR TECHNICAL ASSISTANCE, PRICE INFORMATION AND ORDERING:

In the U.S.A. – Call toll-free 800-227-4224
Outside the U.S.A. – Contact the HACH office or distributor serving you.
On the Worldwide Web – www.hach.com; E-mail – techhelp@hach.com

HACH COMPANY
WORLD HEADQUARTERS
Telephone: (970) 669-3050
FAX: (970) 669-2932

Suspended Solids

Method 8006

Photometric Method¹
(5 to 750 mg/L)

Scope and Application: For water and wastewater

¹ Adapted from *Sewage and Industrial Wastes*, 31, 1159 (1959).



Test Preparation

Collect the following items:

Quantity

Beaker, 600-mL, polypropylene	1
Blender	1
Cylinder, 500-mL polypropylene, graduated	1
Pipet, serological, 25-mL	1
Pipet Filler, safety bulb	1
Sample Cells, 1-inch square, 10 mL	2

Note: Reorder information for consumables and replacement items is on page 3.

Method 8006

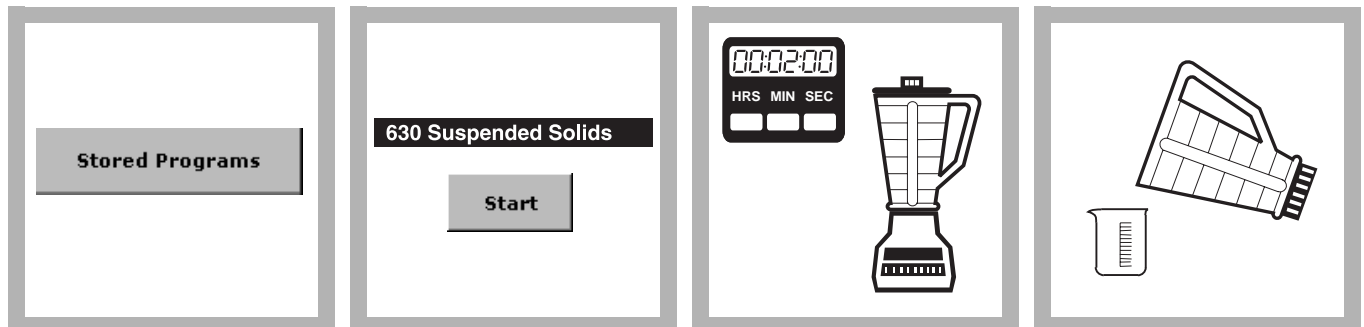

1. Press
STORED PROGRAMS.

2. Select the test.

3. Blend 500 mL of
sample in a blender at
high speed for exactly two
minutes.

4. Pour the blended
sample into a 600-mL
beaker.

Suspended Solids (5 to 750 mg/L)

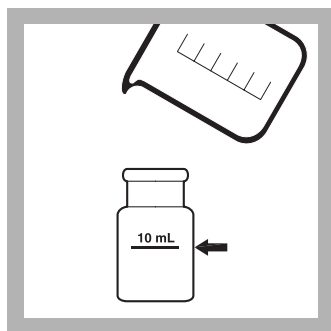

5. Prepared Sample:
Stir the sample and immediately pour 10 mL of the blended sample into a sample cell.

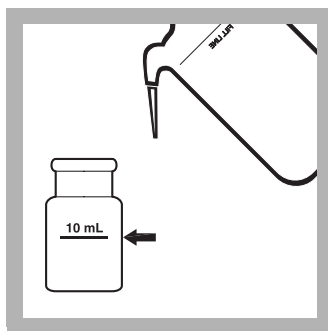

6. Blank Preparation:
Fill a second sample cell with 10 mL of tap water or deionized water.

Remove gas bubbles in the water by swirling or tapping the bottom of the cell on a table.



7. Insert the blank into the cell holder with the fill line facing right.

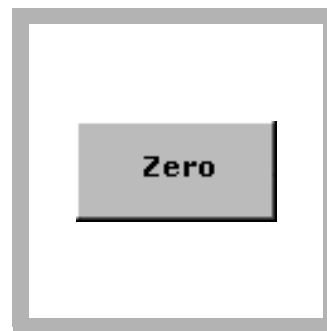

8. Press **ZERO**.
The display will show:
0 mg/L TSS

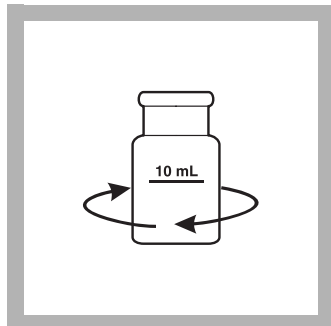

9. Swirl the prepared sample to remove any gas bubbles and uniformly suspend any residue.



10. Insert the prepared sample into the cell holder with the fill line facing right.

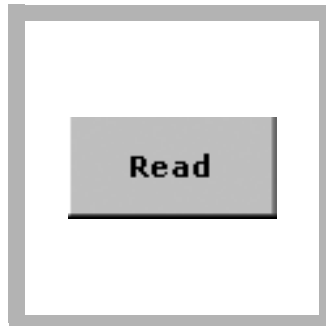

11. Press **READ**.
Results are in mg/L TSS.

Interferences

Samples that absorb strongly at 810 nm, such as blue dyes, may give false, high-bias readings. A user-entered calibration is advised for these samples.

Calibration for this test is based on parallel samples using the gravimetric technique on sewage samples from a municipal sewage plant. For most samples, this calibration will provide satisfactory results. When higher accuracy is required, run parallel spectrophotometric and gravimetric determinations with portions of the same sample. The new calibration should be made on your particular sample using a gravimetric technique as a basis.

Sampling and Storage

Collect samples in clean plastic or glass bottles. Analyze samples as soon as possible after collection. The sample may be stored seven days by cooling to 4 °C (39 °F).

Summary of Method

This method of determining suspended solids is a simple, direct measurement which does not require the filtration or ignition/weighing steps that gravimetric procedures do. The USEPA specifies the gravimetric method for solids determinations, while this method is often used for checking in-plant processes. Test results as mg/L total suspended solids (TSS) are measured at 810 nm.

Consumables and Replacement Items

Required Apparatus

Description	Quantity/Test	Unit	Cat. No.
Beaker, 600-mL, polypropylene	1	each	1080-52
Blender, 1.2-L, 120 VAC	1	each	26161-00
Blender, 1.2 L, 240 VAC	1	each	26161-02
Cylinder, 500-mL graduated, polypropylene	1	each	1081-49
Pipet, serological, 25-mL	1	each	2066-40
Pipet Filler, safety bulb	1	each	14651-00
Sample Cells, 1-inch square, 10 mL, matched pair	2	2/pkg	24954-02



FOR TECHNICAL ASSISTANCE, PRICE INFORMATION AND ORDERING:

In the U.S.A. – Call toll-free 800-227-4224
Outside the U.S.A. – Contact the HACH office or distributor serving you.
On the Worldwide Web – www.hach.com; E-mail – techhelp@hach.com

HACH COMPANY
WORLD HEADQUARTERS
Telephone: (970) 669-3050
FAX: (970) 669-2932

Tannin and Lignin

Method 8193

Tyrosine Method¹
(0.1 to 9.0 mg/L)

Scope and Application: For water, wastewater, and boiler water

¹ Adapted from Kloster, M.B., *Journal American Water Works Association*, Vol. 66, No. 1, p. 44 (1974)



Test Preparation

Before starting the test:

Filter turbid samples and report results as mg/L soluble tannic acid.

Results will be given in mg/L tannins (as tannic acid).

For best accuracy, use a pipet to add the TanniVer[®] 3 solution.

Collect the following items:

Quantity

Tannin and Lignin Reagent Set:

Sodium Carbonate Solution

10 mL

TanniVer[®] 3 Tannin-Lignin Reagent

1 mL

Cylinder, graduated mixing, 25-mL

2

Pipet Filler

1

Pipet, volumetric Class A, 5.0-mL

1

Pipet, volumetric Class A, 0.5-mL

1

Sample Cells, 1-inch square glass, 10-mL

2

Water, deionized

25 mL

Note: Reorder information for consumables and replacement items is on page 4.

Tyrosine

Method 8193



1. Select the test.

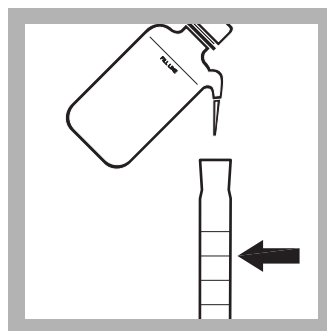

2. **Blank Preparation:**
Fill a 25-mL graduated mixing cylinder to the 25-mL mark with deionized water.

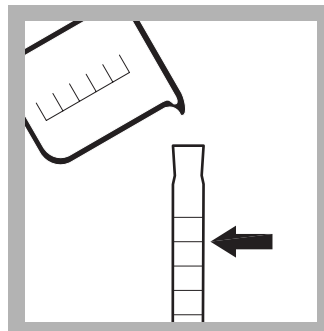

3. **Prepared Sample:**
Fill a second 25-mL graduated mixing cylinder to the 25-mL mark with sample.

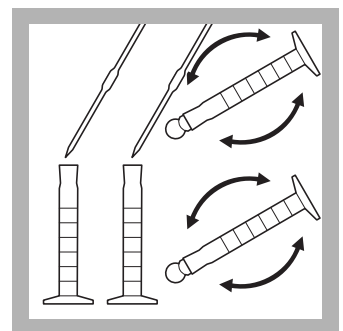

4. Pipet 0.5 mL of TanniVer[®] 3 Tannin-Lignin Reagent into each cylinder. Insert stopper and invert to mix.

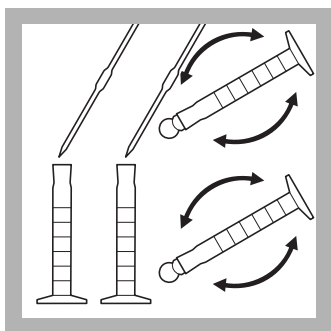

5. Pipet 5.0 mL of Sodium Carbonate Solution into each cylinder. Insert stopper and invert to mix.

A blue color will develop if tannins and/or lignins are present.

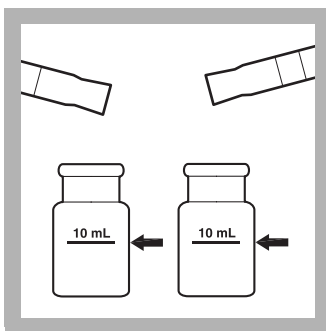

6. Pour 10 mL of each solution into two square sample cells.



7. Press **TIMER>OK**. A 25-minute reaction period will begin.



8. When the timer expires, insert the blank into the cell holder with the fill line facing right.

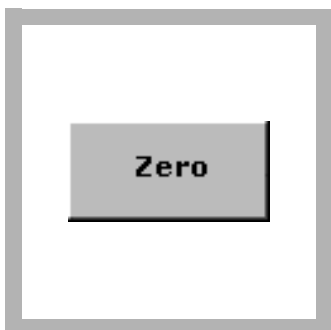

9. Press **ZERO**. The display will show: 0.0 mg/L Tannins (as Tannic Acid)



10. Insert the prepared sample into the cell holder with the fill line facing right.

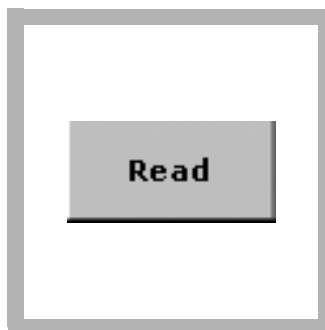

11. Press **READ**. Results are in mg/L Tannins.

Interferences

Table 1 Interfering Substances and Levels

Interfering Substance	Interference Levels and Treatments
Ferrous iron	Causes a positive interference. (2 mg/L of ferrous iron produces a color equivalent to about 1 mg/L of tannic acid.) To eliminate interference of ferrous iron up to 20 mg/L, add one 0.2 g scoop of Sodium Pyrophosphate ¹ to the sample before testing.
Sulfite	Interference is eliminated by adding 1 mL of formaldehyde ¹ to the sample before testing the sample.

¹ See [Optional Reagents and Apparatus](#) on page 4.

Sample Collection, Storage, and Preservation

Collect samples in clean plastic or glass bottles.

Accuracy Check

Standard Solution Method

Prepare a 200-mg/L tannic acid standard solution as follows:

1. Dissolve 0.200 grams of tannic acid in deionized water and dilute to 1000 mL. Prepare this solution monthly. Further prepare a 6.0-mg/L tannic acid standard by diluting 15.00 mL of the stock solution to 500 mL with deionized water. Prepare this standard daily. Perform the tannin and lignin test on the standard solution as described above.
2. To adjust the calibration curve using the reading obtained with the standard solution, press **OPTIONS>MORE** on the current program menu. Press **STANDARD ADJUST**.
3. Press **ON**. Press **ADJUST** to accept the displayed concentration. If an alternate concentration is used, press the number in the box to enter the actual concentration, then press **OK**. Press **ADJUST**.

Summary of Method

This test measures all hydroxylated aromatic compounds, including tannin, lignin, phenol, and cresol. This method produces a blue color proportional to the amount of these compounds present in the sample. The results are reported as total tannin and lignin and expressed as mg/L tannic acid. Test results are measured at 700 nm.

Tannin and Lignin (0.1 to 9.0 mg/L)

Consumables and Replacement Items

Required Reagents

Description	Quantity/Test	Unit	Cat. No.
Tannin and Lignin Reagent Set (up to 100 tests), includes:			22446-00
(2) Sodium Carbonate Solution	10 mL	500 mL	675-49
(1) TanniVer® 3 Tannin-Lignin Reagent	1 mL	100 mL	2560-32
Water, deionized	25 mL	4 L	272-56

Required Apparatus

Description	Quantity/Test	Unit	Cat. No.
Cylinder, mixing, with stopper, 25-mL	2	each	20886-40
Pipet filler, safety bulb	1	each	14651-00
Pipet, volumetric, Class A, 5.0-mL	1	each	14515-37
Pipet, volumetric, Class A, 0.5-mL	1	each	14515-34
Sample Cells, 1-inch square, 10 mL, matched pair	2	2/pkg	24954-02

Recommended Standards and Apparatus

Description	Unit	Cat. No.
Balance, analytical	each	28014-01
Flask, volumetric, 1000 mL	each	14574-53
Flask, volumetric, 500 mL	each	14574-49
Pipet, volumetric, 15.0 mL	each	14515-39
Tannic Acid	113 g	791-14

Optional Reagents and Apparatus

Description	Unit	Cat. No.
Formaldehyde	100 mL	2059-32
Sodium Pyrophosphate	50 g	14295-25



FOR TECHNICAL ASSISTANCE, PRICE INFORMATION AND ORDERING:
In the U.S.A. – Call toll-free 800-227-4224
Outside the U.S.A. – Contact the HACH office or distributor serving you.
On the Worldwide Web – www.hach.com; E-mail – techhelp@hach.com

HACH COMPANY
WORLD HEADQUARTERS
Telephone: (970) 669-3050
FAX: (970) 669-2932

Method 10017

ToxTrak™ Method ^{1, 2, 3}
(0 to 100% Inhibition)

Scope and Application: For drinking water, wastewater and natural waters

¹ U.S. Pat. No. 5,413,916

² Liu, D., Bull. Environ. Contm. Toxicol. 26, 145-149 (1981)

³ Environmental Technology Verification ETV Program evaluated, November, 2003



Test Preparation

Before starting the test:

Important Note: Install the light shield in Cell Compartment #2 before performing this test.

Do not leave the cells in the instrument during incubation. All samples and control cells should be allowed to react under similar conditions of temperature and light.

When testing chlorinated samples, the blank and the samples should be dechlorinated by adding two drops of sodium thiosulfate.

When testing drinking water, the control should be taken from a reservoir of tap water known to be free of toxicants, if possible.

Collect the following items:

Quantity

ToxTrak™ Reagent Set:	
Media Set, Bacterial Count Broth Tubes	1 set
Pipet, transfer, sterile	1
Reaction tubes, with cap	1
Sodium Thiosulfate	varies
ToxTrak™ Reagent Powder Pillows	2
ToxTrak™ Accelerator Solution	4 drops
Water, deionized	varies
Clippers	1
Dropper with 0.5 and 1.0 mL marks	1
Forceps	1
Incubator	1
Light Shield	1
Pipet, volumetric, Class A, 5.00 mL and pipet filler	1

Note: Reorder information for consumables and replacement items is on page 6.

Inoculum Development Using Indigenous Biomass

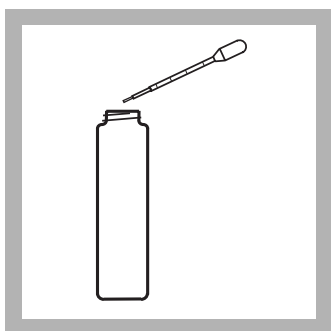

1. Using one of the dropper pipets provided, add 1.0 mL of source culture to a Total Bacteria Count Broth Tube.

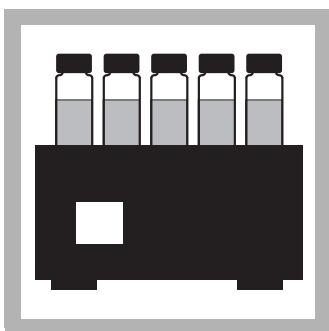

2. Incubate the tube contents at 35 °C (95 °F) until the medium is visibly turbid (approximately 12 hours). Turbidity develops much faster in the incubator than at room temperature.

Note: Commercial sources of freeze-dried bacteria may also be used.

Reaction Tube Colorimetric Test

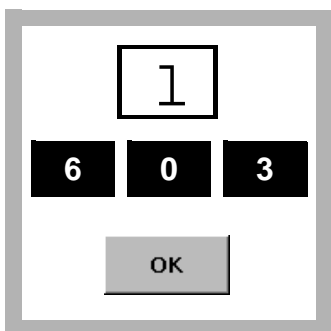

1. Press **SINGLE WAVELENGTH>OPTIONS** then press the λ button. Type in **603 nm** and press **OK**.

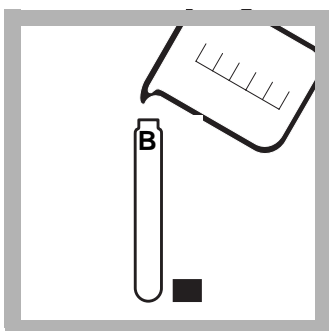

2. **Blank Preparation:** Fill an empty reaction sample cell with deionized water.

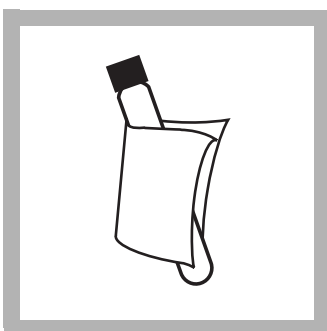

3. Wipe the outside of all the cells with a tissue to remove fingerprints and other marks.

Install the Light Shield in Cell Compartment #2.

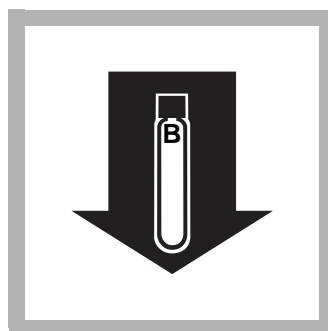

4. Wipe the blank and insert it into the 16-mm round cell holder.

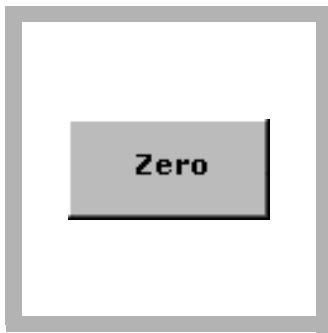

5. Touch ZERO.
The display will show:
0.000 ABS

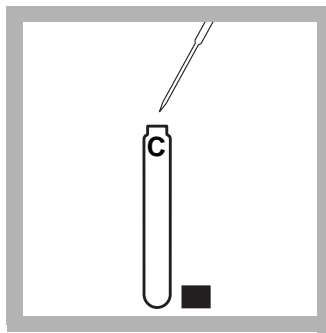

6. Add 5.0 mL of deionized water to the control cell.
Use deionized water that is free of toxicity or another water source that represents baseline toxicity.

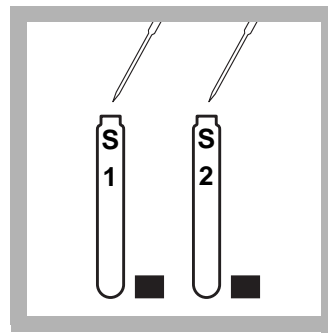

7. Add 5.0 mL of sample (or dilutions) to each sample cell.
To determine the approximate threshold level of toxicity for a sample, dilute 1 mL of sample to 10 mL with deionized water and run the test. Continue to make serial 1/10 dilutions of the sample until a level is reached that gives 0% Inhibition in the final calculation.

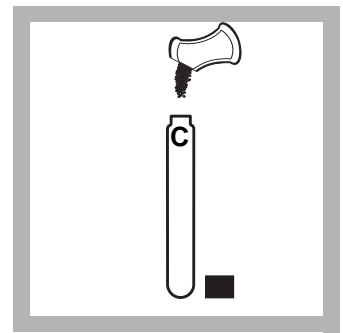

8. Label a cell "control". Open one ToxTrak Reagent Powder Pillow and add the contents to the empty reaction cell.

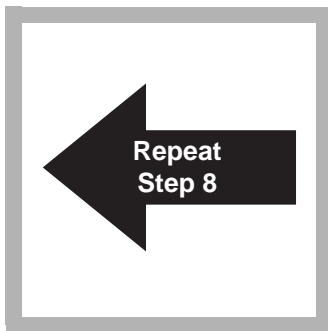

9. For each sample or dilution, repeat step 8 and label each cell.

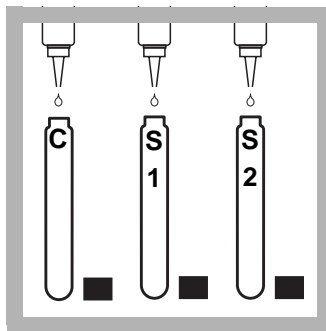

10. Add two drops of Accelerator Solution to each cell.

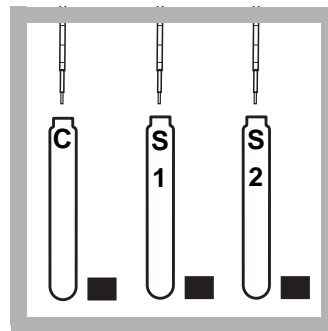

11. Add 0.5 mL of inoculum (previously prepared) to each cell. Cap and shake to mix.

Shaking fully oxygenates the samples and assures that the oxygen concentration is not a factor in determining the respiration rate.



12. Insert the control in the cell holder. Record the absorbance.

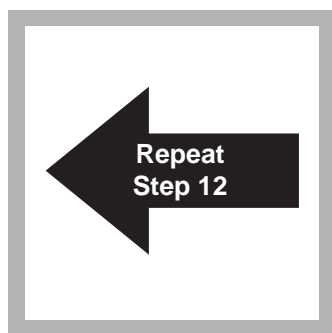

13. Repeat *step 12* for all samples and dilutions. Be sure to record each absorbance.



14. Allow the solutions in the tubes to react until the absorbance of the control decreases 0.60 ± 0.10 abs. This takes 45–75 minutes. Invert occasionally.

Reaction time varies according to temperature, age of the culture, bacteria concentrations, etc.

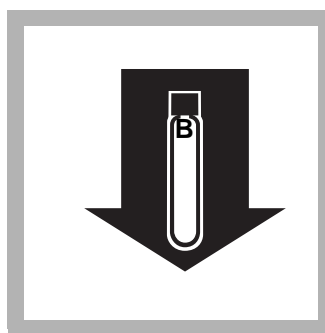

15. After the absorbance of the control has decreased by 0.60 ± 0.10 ABS, insert the blank into the cell holder.

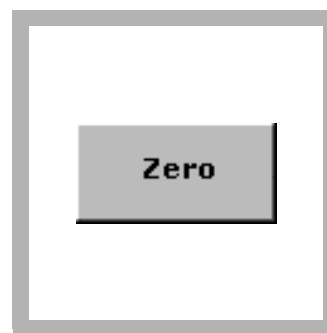

16. Press **ZERO**.
The display will show:
0.000



17. Insert the control into the cell holder.

Press **READ**. The absorbance value of the control will appear.

Record this value.

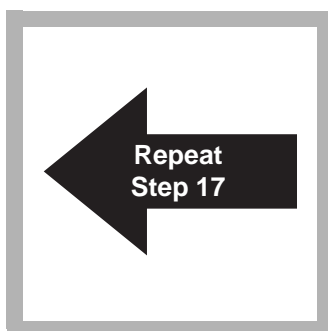

18. Repeat *step 17* for each sample or dilution. Record each absorbance value.

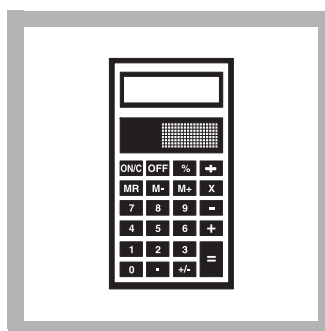

19. Calculate the % Inhibition:

$$\%I = \left[1 - \left(\frac{\Delta A_{\text{sample}}}{\Delta A_{\text{control}}} \right) \right] \times 100$$

Where:

ΔA = Initial absorbance value – Final absorbance value

Some toxins increase respiration and will give a negative percent Inhibition on all respiration-based toxicity tests. After repeated testing, samples that give a percent Inhibition that is more negative than –10% should be considered toxic.

Interpreting Results

The percent Inhibition (%) results obtained are only a relative measurement. They do not represent a true quantitative measurement of toxic concentration. The percent Inhibition does not necessarily increase in direct proportion to the concentration of toxins. To determine the minimum inhibition concentration of a toxin, it is possible to make tenfold dilutions of the sample and determine the percent Inhibition for the dilutions until the sample is diluted sufficiently so that no inhibition is observed. This is the No Observed Effect Concentration (NOEC).

Due to the many variables involved in the test, the limits of detection are on the order of 10% Inhibition. This would correlate to the Lowest Observable Effect Concentration (LOEC). If a sample shows less than 10% Inhibition, repeat the test. After several repetitions, look at the series of data to determine the likelihood of toxicity. Results below 10% are not reliable, but can be used to surmise some presence of toxicity if they are consistent. See examples below:

Data Points: Percent Inhibition	Conclusion
7%, 9%, 5%, 8%, 5%	May be slightly toxic
7%, -4%, -5%, 5%, 1%	Most likely not toxic
-7%, -9%, -5%, -8%, -5%	May be slightly toxic

Some toxins will increase respiration and will give a negative percent Inhibition on this and all other respiration-based toxicity tests. After repeated testing, samples that always give a percent Inhibition that is more negative than -10percent should be considered toxic.

Disposal of Test Cultures

Dispose of active bacterial cultures grown during incubation by using one of these methods:

- Autoclave used test containers at 121 °C (250 °F) for 15 minutes at 15 pounds of pressure. Once the containers are sterile, pour the contents down the drain with running water. The reaction tubes may be washed and re-used.
- Sterilize test containers by using a 1:10 dilution of commercial laundry bleach. Pour the test container contents and test containers into the bleach solution. Allow 10–15 minutes of contact time with the bleach solution. Then pour the liquid down the drain and wash the reaction tubes for reuse.

Summary of Method

This method is based on the reduction of resazurin, a redox-active dye, by bacterial respiration. When it is reduced, resazurin changes color from blue to pink. Toxic substances can inhibit the rate of resazurin reduction. A chemical accelerant has been added to shorten the reaction time. The absorbance of the color change is measured at 603 nm.

Consumables and Replacement Items**Required Reagents**

Description	Quantity/Test	Unit	Cat. No.
ToxTrak™ Reagent Set, includes:	1	25/set	25972-00
Media Set, Total Bacteria Count Tubes	1	15/pkg	22777-00
Pipet, transfer, sterile	1	15/pkg	22325-12
ToxTrak Reagent Powder Pillows	2	50/pkg	25607-66
ToxTrak Accelerator Solution	4 drops	15 mL SCDB	25608-36
Tubes, 16 x 100 mm	1	30 tubes	22758-06
Tube caps for 22758-00	1	30 caps	22411-06
Water, deionized	varies	500 mL	272-49

Required Apparatus

Description	Unit	Cat. No.
Clippers	each	936-00
Dropper, 0.5 and 1.0 mL marks	20/pkg	21247-20
Forceps, flat square tip	each	14537-00
Light Shield	each	LZV646
Incubator Body, 120 V	each	22816-00
Incubator block, Dri-Bath, 12 well	each	22817-00
Pipet, volumetric, Class A, 5.00 mL	each	14515-37
Pipet Filler, safety bulb	each	14651-00

Required Apparatus

Description	Cat. No.
Pipet, TenSette®, 0.1 to 1.0 mL	19700-01
Pipet Tips for TenSette Pipet 19700-01	21856-96
Pipet, TenSette, 1.0 to 10.0 mL	19700-10
Pipet Tips for TenSette Pipet 19700-10	21997-96
Rack, test tube	18641-00



FOR TECHNICAL ASSISTANCE, PRICE INFORMATION AND ORDERING:
In the U.S.A. – Call toll-free 800-227-4224
Outside the U.S.A. – Contact the HACH office or distributor serving you.
On the Worldwide Web – www.hach.com; E-mail – techhelp@hach.com

HACH COMPANY
WORLD HEADQUARTERS
Telephone: (970) 669-3050
FAX: (970) 669-2932

TPH (Total Petroleum Hydrocarbons)

Method 10050

Immunoassay Method¹

Scope and Application: For soil and water

¹ This test is semi-quantitative. Results are expressed as greater or less than the threshold value used.



Test Preparation

This TPH test can be used for both soil and water testing. When testing soil, perform the [Soil Extraction Procedure on page 2](#). See [Soil Extraction Reagents and Apparatus on page 10](#). When testing water samples only, proceed directly with Immunoassay Procedure for Soil Extracts and Water Samples. The test requires about 20 to 30 minutes for complete analysis. As many as 10 cuvettes can be run simultaneously.

Before starting the test:

Read the entire procedure before starting. Identify and make ready all the necessary reagents, cuvettes, and other apparatus before beginning the analysis.

Timing is critical; follow instructions carefully.

A consistent technique when mixing the cuvettes is critical to this test. The best results come from using the cuvette rack and mixing as described in [Using the 1-cm MicroCuvette Rack on page 6](#). Cuvettes can be mixed individually, but test results may not be as consistent.

Handle the cuvettes carefully. Scratches on the inside or outside may cause erroneous results. Carefully clean the outside of the cuvettes with a clean absorbent cloth or tissue before placing them into the instrument.

Antibody cuvettes and enzyme conjugate are made in matched lots. Do not mix reagent lots.

Twenty Antibody Cuvettes are provided with each reagent set. One Antibody Cuvette will be used for each calibrator or sample. Antibody Cuvettes are not reusable.

To avoid damaging the Color Developing Solution, do not expose it to direct sunlight.

Store the reagents at 4 °C when they are not in use. Allow the reagents to reach room temperature before using them in an analysis. Actual testing may be done at temperatures ranging from 1– 38 °C.

The Soil Extractant contains methyl alcohol which is poisonous and flammable. Before using this and other reagents, read the Material Safety Data Sheet (MSDS) for proper use of protective equipment and other safety information.

Protective nitrile gloves are recommended for this procedure.

Collect the following items:

Quantity

TPH Reagent Set	1
Water, deionized	varies
Caps, flip spout	1
Marker, laboratory	1
Rack, for 1-cm Micro Cuvettes	1
Wipes, disposable	1
Pipet, TenSette®, 0.1–1.0 mL and pipet tips	1
Soil Extraction Kit and Soil Scoop	1

Note: Reorder information for consumables and replacement items is on page 10.

Soil Extraction Procedure

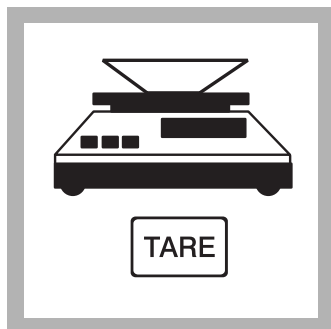

1. Weigh out 5 g of soil in the plastic weighing boat.

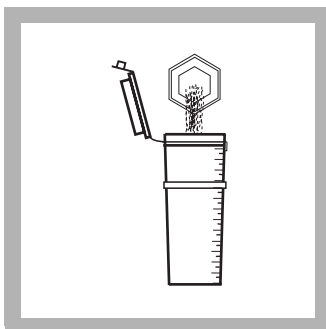

2. Carefully pour the soil into an extraction vial.

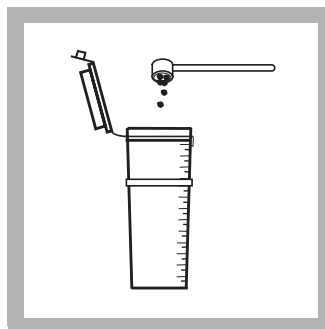

3. Use the 5-gram scoop to add one scoop of sodium sulfate to the extraction vial.



4. Use the graduated cylinder to transfer 10 mL of Soil Extractant into the extraction vial.

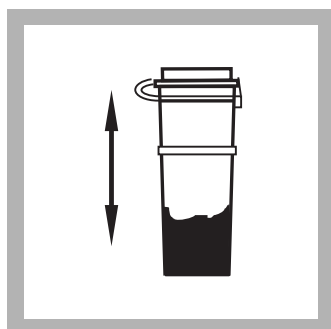

5. Cap the extraction vial tightly and shake vigorously for one minute.



6. Allow to settle for at least one minute. Carefully open the extraction vial.

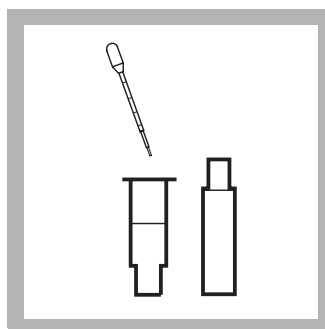

7. Using the disposable bulb pipet, withdraw 1.0–1.5 mL from the liquid layer at the top of the extraction vial.

Transfer it into the filtration barrel (the bottom part of the filtering assembly into which the plunger inserts).

Do not use more than 1.5 mL. The bulb is marked in 0.25-mL increments.

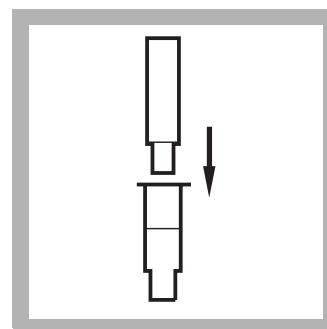

8. Insert the filtration plunger into the filtration barrel. Press firmly on the plunger until the sample extract is forced upward into the center of the plunger.

Use the resultant filtrate for the immunoassay in the [Immunoassay for Soil Extracts and Water Samples on page 3](#).

It may be necessary to place the filtration assembly on a table and press down on the plunger.

Immunoassay for Soil Extracts and Water Samples

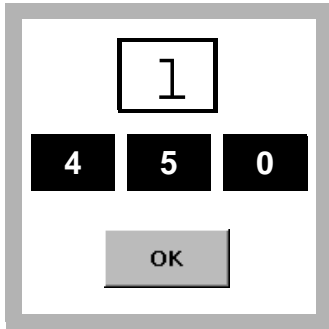

1. Press
SINGLE
WAVELENGTH>OPTIONS
 then press the λ button.
 Type in **450 nm** and
 press **OK**.

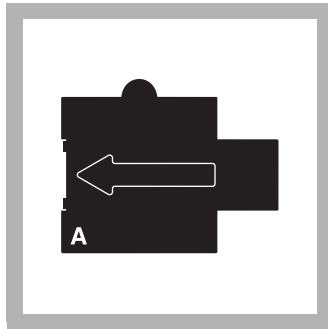

2. Insert Adapter A.

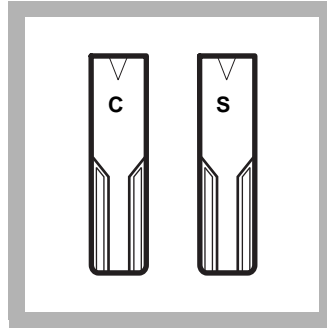

Label an Antibody Cuvette
 for each calibrator and
 each sample to be tested.
 To select the proper
 calibrators, see [Table 2 on
 page 8](#) or [Table 3 on page
 8](#).

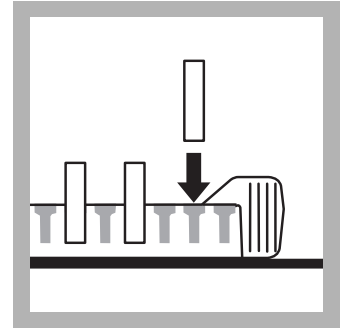

3. Insert the cuvettes into
 the rack snugly.

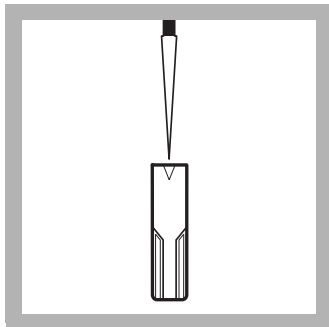

4. Pipet 0.5 mL of Diluent
 Solution into each
 Calibrator cuvette.
 The same pipette tip can be
 used repeatedly for this
 step.

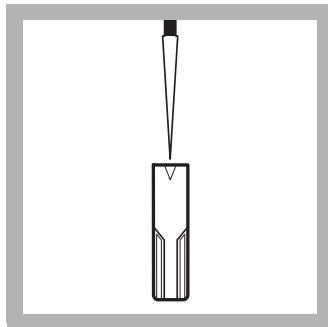

5. **If testing soil:** Pipet
 0.5 mL of *Diluent Solution*
 into each sample cuvette.
If testing water: Pipet
 0.5 mL of each *water
 sample* into the appropriate
 cuvette. Use a new pipette
 tip for each water sample.

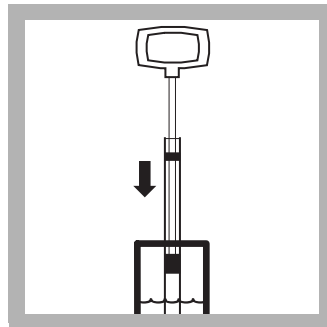

6. Have the necessary
 apparatus at hand for the
 next four steps as they
 must be done without
 delay.
 Use a Wiretrol® pipet to
 transfer 50 μ L of each
 calibrator to be used into
 the calibrator cuvettes.

Mix the contents of the
 cuvettes after each
 addition. Use a separate
 capillary tube for each
 solution.

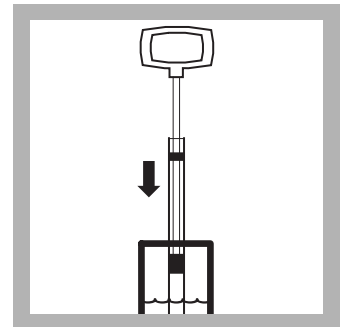

7. **If testing soil:** Use a
 Wiretrol pipet to transfer
 50 μ L of the filtered extract
 from step 8 of the [Soil
 Extraction Procedure](#) into
 the appropriately labeled
 cuvette. Use a separate
 capillary tube for each
 solution.

Mix the contents of the
 cuvettes after the addition
 of each sample.

If testing water: Use a
 Wiretrol pipet to transfer
 50 μ L of methanol into each
 sample cuvette

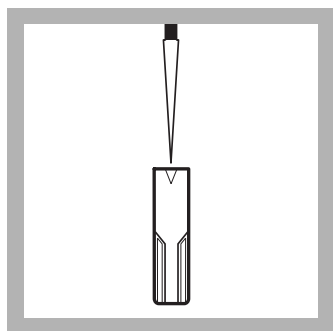

8. Immediately pipet 0.5 mL of TPH Enzyme Conjugate into each calibrator and sample cuvette.

The same pipette tip can be used repeatedly for this step.

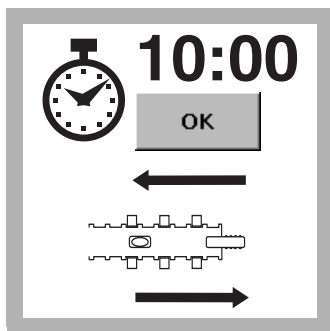

9. Press **TIMER**. Enter **10:00** minutes and press **OK**.

A 10-minute reaction time will begin. Proceed immediately to the next step.

Mix the contents of the cuvettes for 30 seconds using the technique described in [Using the 1-cm MicroCuvette Rack on page 6](#).



10. After 5 minutes, mix the contents of the rack a second time for a period of 30 seconds using the same technique.

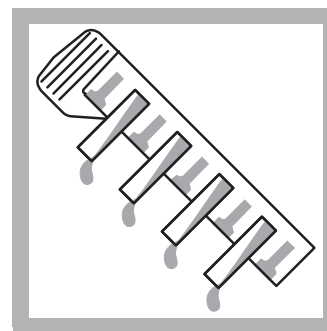

11. At the end of the 10-minute period, discard the contents of all the cuvettes into an appropriate waste container.

Color Development

Important Note: Timing is critical. Follow instructions carefully.

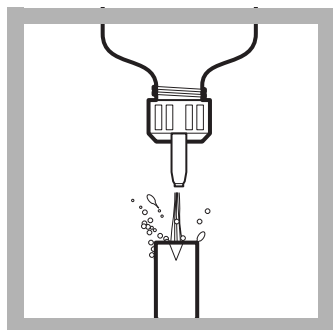

12. Wash each cuvette forcefully and thoroughly four times with deionized water. Empty the rinse water into the waste container.

Ensure most of the water is drained from the cuvettes by turning the cuvettes upside down and tapping them lightly on a paper towel.

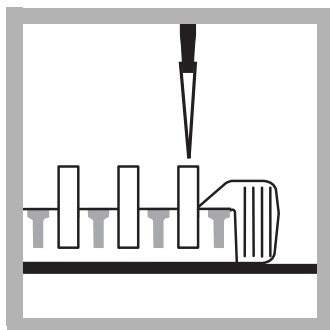

13. With the cuvettes still held snugly in the rack, pipet 0.5 mL of Color Developing Solution into each Antibody Cuvette.

Use a new pipette tip for each cuvette.

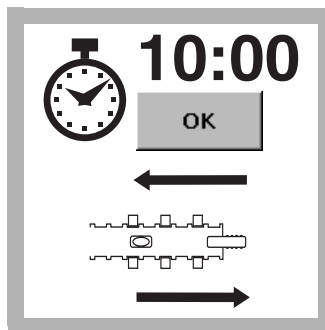

14. Press **OPTIONS>TIMER**. Enter **10:00** minutes and press **OK**.

A reaction period will begin. Mix, using the instructions in [Using the 1-cm MicroCuvette Rack on page 6](#).



15. After 5 minutes, mix the contents of the rack a second time for a period of 30 seconds using the same technique.

Solutions will turn blue in some or all of the cuvettes.

Measuring the Color

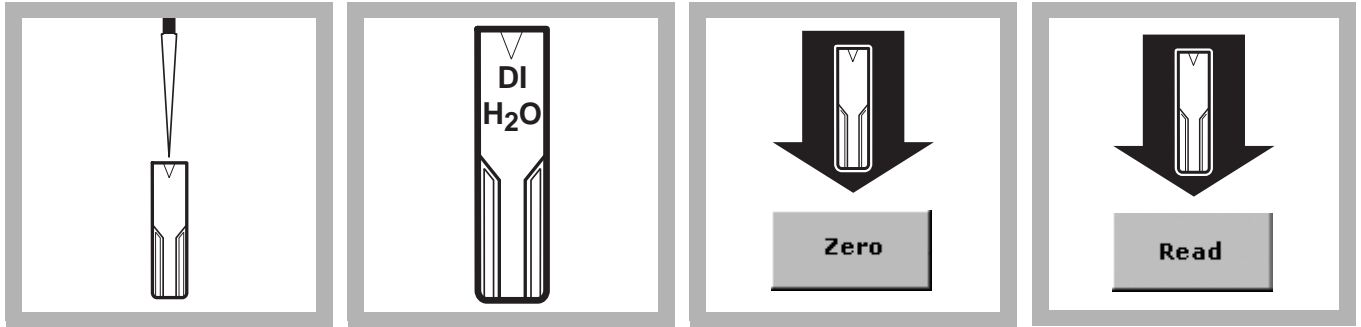

16. At the end of the 10-minute reaction period, pipette 0.5 mL of Stop Solution into each cuvette in the same order as the Color Developing Solution was added in step 12. Use the same pipette tip repeatedly for this step.

Slide the rack for 20 seconds ([Using the 1-cm MicroCuvette Rack on page 6.](#))

Blue solutions will turn yellow with the addition of the Stop Solution.

17. Label and fill a Zeroing Cuvette with deionized water. Wipe the outside of all the cuvettes with a tissue to remove water, smudges, and fingerprints.

18. Insert the filled zeroing cuvette into the cell holder with the arrow to the right.

Orient the arrow in the same direction for all cuvettes.

Press **ZERO**.

The display will show:

0.000 Abs

19. Insert the first calibrator into the cell holder.

Press **READ**. The display will give an absorbance reading. Record the results for each calibrator and sample.

Repeat this step for all remaining calibrators and samples.

See [Interpreting and Reporting Results](#) for help with interpretation of results.

Using the Wiretrol®* Pipet

The Wiretrol Pipet can accurately measure small quantities of liquids. It consists of two parts: a Teflon®-tipped plunger and a calibrated capillary tube. The plunger can be reused; the capillary tubes must be discarded after one use..

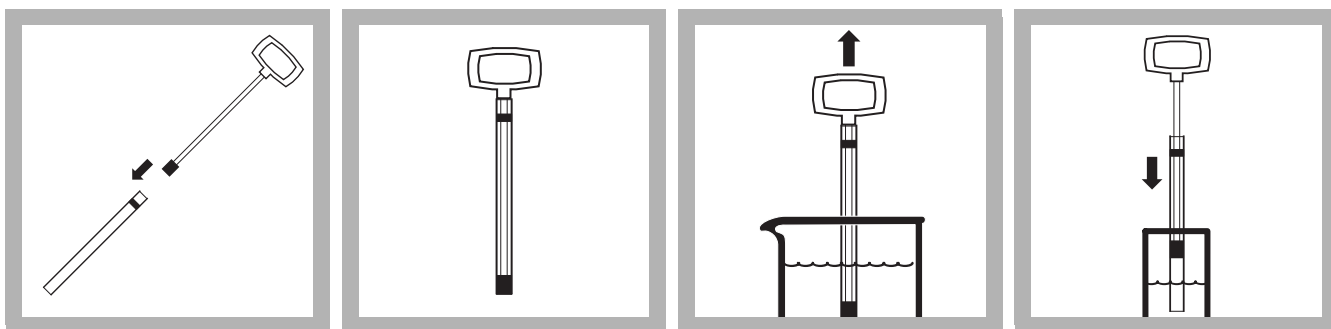

1. Wet the orange Teflon® tip of the Wiretrol plunger in the sample and carefully insert it into the end of the capillary tube with the colored band.

2. Push the tip to the other end of the capillary tube until it barely extends beyond the end of the capillary tube.

3. Submerge the capillary tube below the surface of the liquid to be pipetted. Slowly and smoothly draw the Wiretrol plunger up until the bottom of the plunger tips reaches the appropriate volume line.

Touch the end of the tube to the side of the vessel to release remaining drops on the capillary tube tip.

4. To discharge the pipet, place the tip of the capillary tube below the surface of the solution and push the Wiretrol plunger down in one smooth motion. Change capillary tubes for each calibrator and sample.

Using the 1-cm MicroCuvette Rack

This rack (Figure 1) has been designed specifically to aid in achieving precise and accurate results when using the immunoassay technique to analyze several samples at the same time.

Figure 1 The 1-cm MicroCuvette Rack

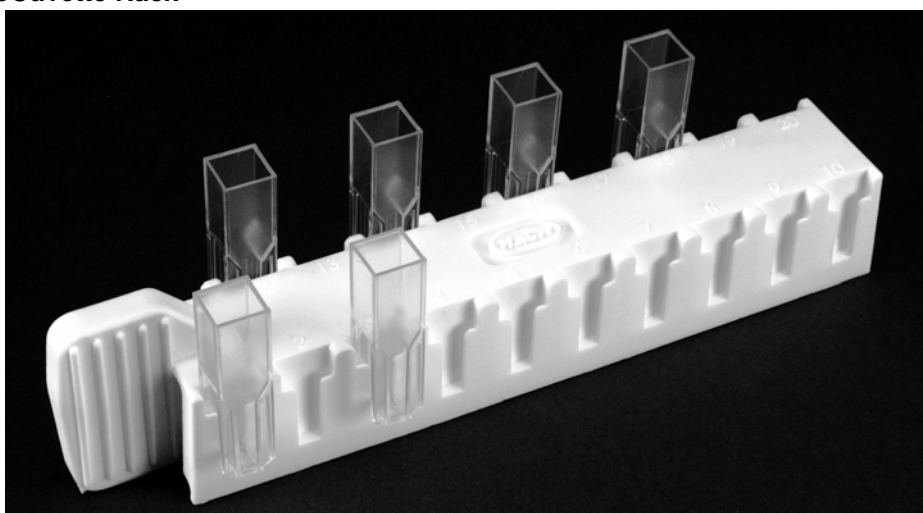

* Wiretrol is a registered trademark of Drummond Scientific.

Loading the Rack—The cuvette rack is designed so that it may be inverted with the cuvettes in place. Identify each cuvette with a sample or calibrator number and insert all the cuvettes in the rack before beginning the procedure. Fit the cuvettes snugly into the rack, but do not force them or they may be difficult to remove and their contents may spill. The cuvettes should remain in place when the rack is inverted and tapped lightly.

Mixing—Set the rack on a hard, flat surface that is at least twice the length of the rack. Hold the rack by one end and vigorously slide it back and forth along its long axis for 30 seconds. The rack should move through a distance equal to its own length in each direction.

Interpreting and Reporting Results

There is an inverse relationship between the concentration of TPH and the reading. In other words, the higher the reading, the lower the concentration of TPH.

Table 1 Relative TPH Concentration

If the sample reading is...	the sample TPH Concentration is...
...less than calibrator reading	...greater than the calibrator concentration
...greater than calibrator reading	...less than the calibrator concentration

Example

Readings:

TPH Calibrator #1: **0.480 Abs**

TPH Calibrator #2: **0.360 Abs**

Sample #1: **0.200 Abs**

Sample #2: **0.400 Abs**

Sample #3: **0.550 Abs**

Interpretation for a Soil Sample

Sample #1—Sample reading is less than the readings for both calibrators. Therefore the sample concentration of TPH is greater than both 20 ppm and 50 ppm diesel fuel.

Sample #2—Sample reading is between the readings for the TPH calibrators. Therefore the sample concentration of TPH is between 20 ppm and 50 ppm diesel fuel.

Sample #3—Sample reading is greater than the readings for both calibrators. Therefore the sample concentration of TPH is less than both 20 ppm and 50 ppm diesel fuel.

Interpretation for a Water Sample

Sample #1—Sample reading is less than the readings for both calibrators. Therefore the sample concentration of TPH is greater than both 2 ppm and 5 ppm diesel fuel.

Sample #2—Sample reading is between the readings for the TPH calibrators. Therefore the sample concentration of TPH is between 2 ppm and 5 ppm diesel fuel.

Sample #3—Sample reading is greater than the readings for both calibrators. Therefore the sample concentration of TPH is less than both 2 ppm and 5 ppm diesel fuel.

Storing and Handling Reagents

- Wear protective gloves and eyewear.
- When storing reagent sets for extended periods of time, keep them out of direct sunlight. Store reagents at a temperature of 4 °C when not in use.

TPH (Total Petroleum Hydrocarbons)

- Keep the foil pouch containing the Antibody Cuvettes sealed when not in use.
- If Stop Solution comes in contact with eyes, wash thoroughly for 15 minutes with cold water and seek immediate medical help.

Sensitivity

The antibodies used in the TPH Test Kit react with a variety of compounds found in petroleum fuels; however, each TPH calibrator has been formulated to represent a specific concentration of diesel fuel. To use the calibrators for other TPH compounds, see *Table 1* or *Table 2* to select the proper TPH calibrator for the compound, sample, and range you want to test.

Example:

To use the TPH calibrators for gasoline, find “Gasoline” in the first column of [Table 2](#) or [Table 3](#). Read across the column to find the ppm represented by each calibrator. For gasoline, calibrator #1 = 15 ppm, calibrator #2 = 35 ppm, and so forth.

Table 2 Various TPHs in Soil

Compound	TPH calibrator #1	TPH calibrator #2	TPH calibrator #3	TPH calibrator #4
	ppm			
Diesel	20	50	100	200
Gasoline	15	35	70	140
Kerosene	35	75	140	250
Benzene	20	45	85	160
Toluene	15	30	50	90
Ethylbenzene	5	15	35	75
m-Xylene	9	20	35	70
o-Xylene	10	20	40	80
p-Xylene	3	5	9	16
BTEX	5	15	25	45

Table 3 Various TPHs in Water

Compound	TPH calibrator #1	TPH calibrator #2	TPH calibrator #3	TPH calibrator #4 ¹
	ppm			
Diesel	2	5	10	20
Gasoline	1.5	3.5	7	14
Kerosene	3.5	7.5	14	25
Benzene	2	4.5	8.5	16
Toluene	1.5	3	5	9
Ethylbenzene	0.5	1.5	3.5	7.5
m-Xylene	0.9	2	3.5	7
o-Xylene	1	2	4	8
p-Xylene	0.3	0.5	0.9	16
BTEX	0.5	1.5	2.5	4.5

¹ To test concentrations in water higher than those covered by the calibrators, dilute the original sample as described below.

Diluting Water Samples

Higher concentrations in water can be tested by first diluting the sample with deionized water (see [Sensitivity on page 8](#)). Test for other TPH compounds (i.e., gasoline) by using the

conversion factors given in Table 2 and Table 3. Dilute the sample to 50 mL with deionized water in a graduated cylinder.

Choose the mL of sample from Table 4. Use the multiplier value for the chosen quantity to multiply the value from Table 3.

Table 4 Sample Multipliers

mL Sample	Multiplier
0.5	100
1.0	50
2.0	25
5.0	10
10.0	5
25.0	2

For example: If a 0.5 mL water sample is diluted to 50 mL and tested, the calibrator levels for diesel fuel in water would represent 200, 500, 1000, and 2000 ppm respectively.

Interferences

Table 5 Interfering Substances and Levels

Interfering Substance	Interference Levels and Treatments
Chlorine in water samples	Interferes above 2 ppm. Remove with sodium thiosulfate

Sample Collection and Storage

Analyze the samples as soon as possible after collection. If the samples must be stored, collect them in glass or Teflon® containers that have been washed with soap and water and rinsed with methanol. The container should be capped with a Teflon-lined cap. If a Teflon cap is not available, aluminum foil rinsed in methanol may be used as a substitute cap liner.

When collecting water samples, fill the container completely (no head space) and cover the container with a tightly-sealed lid immediately after collection.

For Soil: Store the samples at 4 °C (40 °F) for no longer than 14 days.

For Water: Chill the sample in an ice bath or refrigerator to limit the loss of volatile compounds. Store samples no longer than 24 hours.

Summary of Method

This method provides semi-quantitative screening based on thresholds for TPH as diesel fuel in the following concentrations:

Soil	20, 50, 100, 200 ppm as diesel fuel
Water	2, 5, 10, 20 ppm as diesel fuel

Immunoassay tests use antigen/antibody reactions to test for specific organic compounds in water and soil. Antibodies specific for TPH are attached to the walls of plastic cuvettes. They selectively bind and remove TPH from complex sample matrices. A prepared sample and a reagent containing enzyme-conjugate molecules (analyte molecules attached to molecules of an enzyme) are added to the Antibody Cuvettes. During incubation, enzyme-conjugate molecules and TPH compete for binding sites on the antibodies. Samples with higher levels of

TPH (Total Petroleum Hydrocarbons)

analyte will have more antibody sites occupied by TPH and fewer antibody sites occupied by the enzyme-conjugate molecules.

After incubation, the sample and unbound enzyme conjugate are washed from the cuvette and a color-development reagent is added. The enzyme in the conjugate catalyzes the development of color. Therefore, there is an inverse relationship between color intensity and the amount of TPH in the sample. The resulting color is then compared with a calibrator to determine whether the TPH concentration in the sample is greater or less than the threshold levels. The TPH concentration is inversely proportional to the color development: the lighter the color, the higher the TPH concentration. Test results are measured at 450 nm.

Consumables and Replacement Items

Required Reagents

Description	Unit	Cat. No.
TPH Reagent Set ¹	20 cuvettes	27743-00
Deionized Water	500 mL	272-48

¹ Immunoassay components are manufactured by Beacon Analytical Systems, Inc.

Required Apparatus

Description	Unit	Cat. No.
Adapter, 1-cm square cell	each	
Caps, flip spout	2/pkg	25818-02
Marker, laboratory	each	20920-00
Rack, for 1-cm Micro Cuvettes	each	48799-00
Wipes, disposable	box	20970-00
Pipet, TenSette®, 0.1–1.0 mL	each	19700-01
Pipet Tips, for TenSette Pipet 19700-01	1000/pkg	21856-28

Soil Extraction Reagents and Apparatus

Description	Unit	Cat. No.
Balance, AccuLab Pocket Pro 250 B	each	27969-00
Gloves, disposable, Nitrile, medium	each	25505-02 ¹
Pipet tips for 19700-01	50/pkg	21856-96
Soil Scoop, 5-g, 4.25-cc	20/pkg	26572-05
Soil Extraction Refill Kit, includes:	each	27752-00
Dropper, LDPE, 0.5 and 1.0-mL	20/pkg	21247-20
Filter and Barrel Assembly	20/pkg	25676-20
Sodium Sulfate, anhydrous	250 g	7099-29
Soil Extractant Solution	200 mL	25677-29
Soil Sample Container	20/pkg	25929-20
Weighing Boat, 8.9-cm square	20/pkg	21790-20
Spatula, disposable	2/pkg	25693-20

¹ Other sizes available.



FOR TECHNICAL ASSISTANCE, PRICE INFORMATION AND ORDERING:
In the U.S.A. – Call toll-free 800-227-4224
Outside the U.S.A. – Contact the HACH office or distributor serving you.
On the Worldwide Web – www.hach.com; E-mail – techhelp@hach.com

HACH COMPANY
WORLD HEADQUARTERS
Telephone: (970) 669-3050
FAX: (970) 669-2932

Trihalomethanes

Method 10132

THM Plus™ Method

Water Bath Method

(10 to 600 ppb as Chloroform)

Scope and Application: For screening THMs in drinking water samples and Formation Potential tests.



Test Preparation

Before starting the test:

If analyzing more than four samples, use 450 mL of water in the water bath.

THM Plus Reagent 2 **must** be at room temperature before use.

A Repipet Jr. may be used in place of the TenSette® Pipet.

Trihalomethane compounds are extremely volatile. Immediately cap sample cells after filling with sample.

Reagent blank is stable for 1–2 hours and need not be prepared for each test.

Collect the following items:

Quantity

THM Plus Reagent Set	varies
Beaker, 600-mL	1
Cell Holder Assembly, TTHM	1
Evaporating Dish, 125 mm x 65 mm	1
Hot Plate, 7 x 7 inch	1
Pipet, TenSette®, 0.1–1.0 mL and tips	1
Pipet, TenSette®, 1–10 mL and tips	1
Sample Cells, 10 mL, with caps.	2
Sample Cells, 10-mL, 1-inch square, matched pair	2
Wipers, disposable, KimWipes®	varies

Note: Reorder information for consumables and replacement items is on page 7.



1. Press
STORED PROGRAMS.

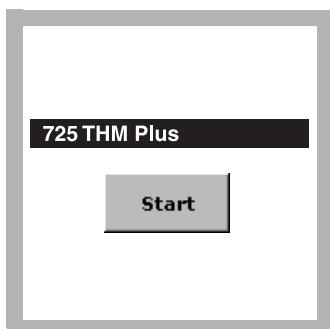

2. Select the test.

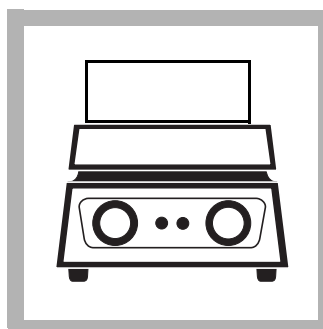

3. Prepare a hot water bath by adding 500 mL of water to an evaporating dish. Put the dish on a hot plate and turn the heater on high.

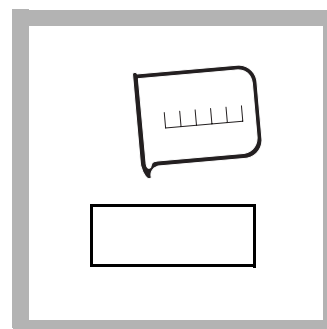

4. Prepare a cooling bath by adding 500 mL of cold (18–25 °C) tap water to a second evaporating dish. Put the dish on a hot plate and turn the heater on high. Maintain the temperature in this range.

Important Note: Perform steps 5–10 rapidly to avoid loss of THMs from the sample. When testing more than one sample, complete steps 5–10 for one sample before going on to another. If dispensing sample with a pipette, the pipette must dispense quickly without causing aeration or back pressure.



5. **Prepared Sample:** Fill one round sample cell to the 10-mL mark with sample. Cap and label as “sample”.



6. **Blank Preparation:** Fill the second sample cell with deionized water. Cap and label as “blank”.

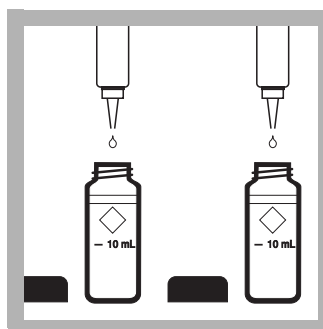

7. Add three drops of THM Plus Reagent 1 to each cell.

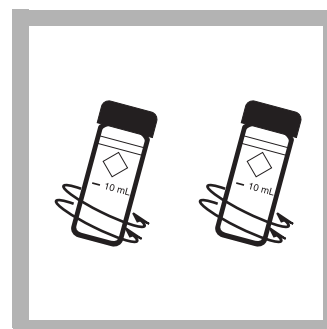

8. Cap tightly and mix gently by swirling each cell three times.

Vigorous shaking can cause loss of THMs into the sample cell headspace.

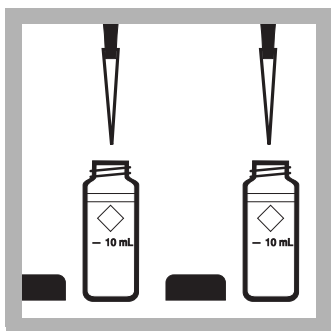

9. Use a TenSette® Pipet to add 3 mL of THM Plus Reagent 2 to each cell. Avoid excess agitation of the sample when dispensing the reagent.

The reagent is viscous and a small amount may remain on the tip after dispensing. This will not affect the results.

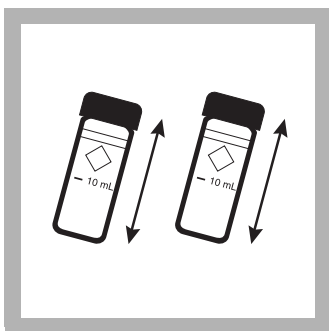

10. Cap tightly and mix by shaking.

Thorough mixing ensures that all of the THM goes into the liquid and does not accumulate in the air above the sample.

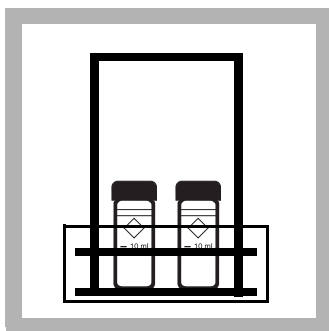

11. Place the sample cells in the cell holder assembly.

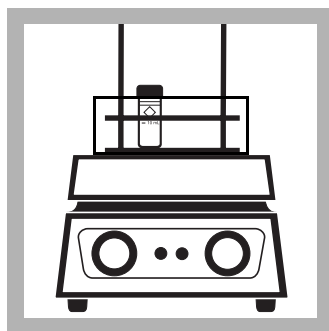

12. Place the assembly in the hot water bath when the water is boiling rapidly.

Do not allow the water to rise above the white “diamond” near the top of the sample cells.



13. Press **TIMER>OK**. A five-minute reaction period will begin.

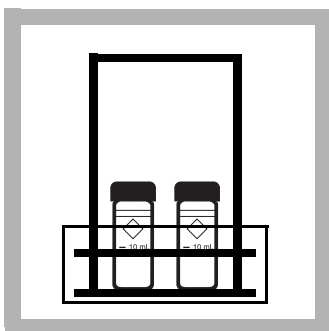

14. When the timer expires, remove the assembly and sample cells from the hot water bath. Place in the cooling bath.

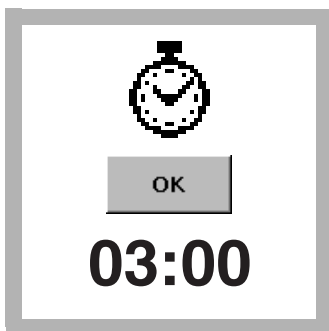

15. Press **TIMER>OK**. A three-minute cooling period will begin. When the timer expires, remove the cells from the cooling bath.

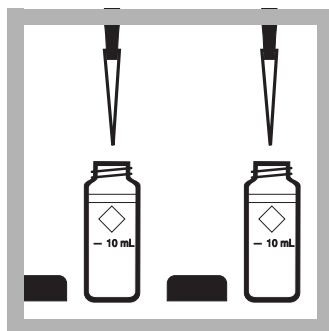

16. Use a TenSette Pipet to add 1 mL of THM Plus Reagent 3 to each cell. The sample and blank will become warm.

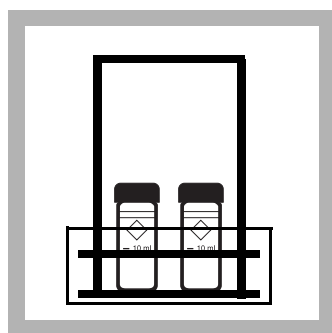

17. Replace the cooling water with fresh, cold tap water. Place the assembly that contains the sample and blank cells into the cooling bath.



18. Press **TIMER>OK**.
A second three-minute cooling period will begin.
After the timer expires, remove the cells from the cooling bath.
The temperature of the sample should be 15–25 °C.

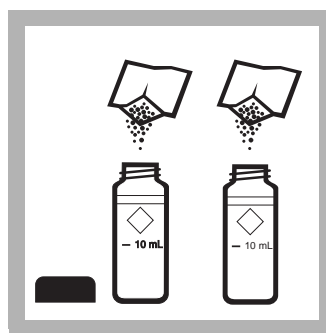

19. Add the contents of one THM Plus Reagent 4 Powder Pillow to the sample cell and one to the blank.

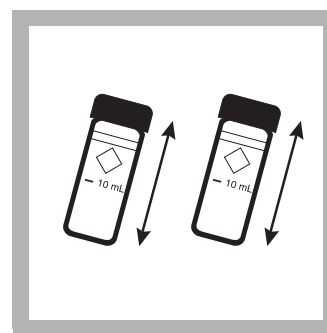

20. Cap each cell tightly and mix by shaking until all the powder dissolves.
The powder dissolves slowly. Intermittent shaking during the first five minutes of the color development period will help dissolve the reagent powder.



21. Press **TIMER>OK**.
A 15-minute development time will begin.

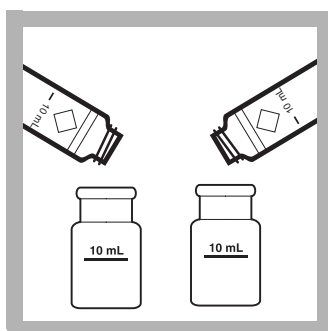

22. After the timer expires, pour the prepared sample and prepared blank into two square sample cells.

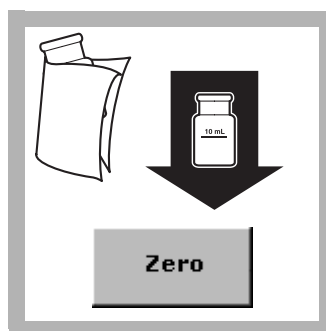

23. Insert the blank into the cell holder with the fill line facing right. Close the cover.
Press **ZERO**.
The display will show:
0 ppb CHCl_3

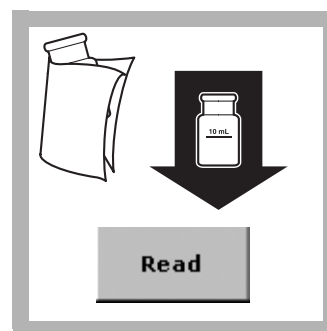

24. Insert the prepared sample into the cell holder with the fill line facing right. Close the cover.
Press **READ**.
Results are in ppb chloroform.
“Underrange” will appear in the display if results are below the Estimated Detection Limit.

Interferences

The substances in [Table 1](#) have been tested and found not to interfere up to the indicated levels (in ppm):

Table 1 Interferences That Have No Effect Up to the Maximum Level Tested

Interfering Substance	Interference Levels and Treatments
Chlorine	<10 ppm
Copper	<1000 ppm
Hardness, Ca	<1000 ppm as CaCO ₃ May have some turbidity until Reagent 3 is added
Hardness, Mg	<4000 ppm as CaCO ₃ May have some turbidity until Reagent 3 is added
Iron	<10 ppm
Lead	<2 ppm
Mercury	<10 ppm
Monochloramine	<20 ppm
Nickel	<10ppm
Sodium Bisulfite	<100 ppm
EDTA	Interferes negatively at all levels

Table 2 Additional Disinfection By-Products That React

Compound	Effect
1,1,1-trichloro-2-propanone	Interferes positively
1,1,1-trichloroacetone	Interferes positively
Chloral hydrate	Interferes positively
Dibromochloroacetic acid	Interferes positively
Dichlorobromoacetic acid	Interferes positively
Tribromoacetic acid	Interferes positively
Trichloroacetic acid	Interferes positively

Sampling and Storage

Collect samples in 40-mL glass bottles sealed with Teflon[®]-lined septa caps. Fill the bottles slowly to overflowing so that no air is included with the sample. Seal the bottles tightly and invert to check that no air has been trapped.

Because trihalomethane compounds (THMs) are extremely volatile, immediate analysis yields the greatest accuracy. If the samples cannot be analyzed immediately, cool samples to 4 °C. This will slow the formation of any additional THM compounds in chlorinated samples. Store the samples at 4 °C in an atmosphere free of organic vapors. Samples should not be held more than 14 days. Allow the samples to equilibrate to 15–25 °C before analyzing.

Accuracy Check

Standard Additions Method (Sample Spike)

Prepare the standard additions sample at the same time as the unspiked water sample.

1. Snap the neck off a THM Standard Ampule, 10 ppm as chloroform.
2. Using a Wiretrol™ Pipet, add 0.050 mL of the standard to 10 mL of water sample. Immerse the tip of the pipet below the surface of the water sample and dispense the aliquot of chloroform standard.
3. Cap the sample cell immediately and swirl three times to mix. Prepare the sample and the spiked sample according to the procedure steps 7–24.
4. After reading test results, leave the sample cell (unspiked sample) in the instrument. Verify that the units displayed are in ppb.
5. Press **OPTIONS>MORE**. Press **STANDARD ADDITIONS**. A summary of the standard additions procedure will appear.
6. Press **OK** to accept the default values for standard concentration, sample volume, and spike volume. Press **EDIT** to change these values. After values are accepted, the unspiked sample reading will appear in the top row
7. Insert the prepared spiked sample into the cell holder. Press **READ**.
8. After completing the sequence, press **GRAPH** to view the best-fit line through the standard additions data points. Press **IDEAL LINE** to view the relationship between the sample spikes and the “Ideal Line” of 100% recovery. The addition should reflect 80–120% recovery.

CAUTION

Chloroform is extremely volatile! Do not shake it when mixing.

Standard Solutions Method

Prepare a 99 ppb chloroform standard by pipetting 10.0 mL of organic-free water into a sample cell. Snap the neck off a THM Standard Ampule, 10 ppm as chloroform. Using a Wiretrol Pipette, transfer 0.100 mL of the chloroform standard into the organic-free water. Immerse the end of the pipet tip under the water to dispense the chloroform. Cap the sample cell immediately and swirl three times to mix. Immediately perform steps 7–24 of the procedure. Do not make up the standard in advance. Use the standard immediately upon preparation.

Summary of Method

The THM Plus method reacts with the trihalogenated disinfection by-products formed as the result of the disinfection of drinking water with chlorine in the presence of naturally occurring organic materials. These disinfection by-products (DBPs) may be produced in the treatment plant or the distribution system as long as the water is in contact with free chlorine residual. The formation of the DBPs is influenced by chlorine contact time, chlorine dose and residual, temperature, pH, precursor concentration, and bromide concentration.

The predominant DBPs formed by the chlorination of drinking water are the trihalomethanes or THMs. The four trihalogenated compounds that form are chloroform, bromoform, dichlorobromomethane, and dibromochloromethane. These four compounds comprise the Total Trihalomethanes (TTHMs) group which is regulated under the Safe Drinking Water Act. The combined concentration of the TTHMs, is regulated to be 80 ppb or less in drinking water samples. Other DBPs that may be present and react under the conditions of the THM Plus method are listed in Interferences.

In the THM Plus method, THM compounds present in the sample react with N, N,-diethylnicotinamide under heated alkaline conditions to form a dialdehyde intermediate.

The sample is then cooled and acidified to pH 2.5. The dialdehyde intermediate formed is then reacted with 7-amino-1,3 naphthalene disulfonic acid to form a colored Schiff base. The color formed is directly proportional to the total amount of THM compounds present in the sample. Test results are measured at 515 nm and reported as ppb chloroform.

Consumables and Replacement Items

Required Apparatus

Description	Quantity/Test	Unit	Cat. No.
Reagent Set (50 tests ¹), includes:			27908-00
THM Plus™ Reagent 1	6 drops	15 mL	27539-29
THM Plus™ Reagent 2	6 mL	330 mL	27540-48
THM Plus™ Reagent 3	2 mL	110 mL	27541-42
THM Plus™ Reagent 4	2 pillows	100 pillows	27566-99

¹ Fifty tests equals 25 samples and 25 individual blanks. Additional tests can be obtained when multiple samples are run using a single blank.

Required Apparatus

Description	Quantity/Test	Unit	Cat. No.
Beaker, 600-mL	1	each	500-52
Cell Holder Assembly, TTHM	1	each	47880-00
Evaporating Dish, 125 mm x 65 mm	1	each	27647-00
Hot Plate, 7 x 7 in., 120 VAC, digital	1	each	28816-00
Hot Plate, 7 x 7 in., 240 VAC, digital	1	each	28816-02
Pipet, TenSette®, 0.1–1.0 mL	1	each	19700-01
Pipet Tips for TenSette Pipet 19700-01	varies	50/pkg	21856-96
Pipet, TenSette®, 1–10 mL	1	each	19700-10
Pipet Tips, for TenSette Pipet 19700-10	varies	50/pkg	25589-96
Sample Cells, 10 mL, with caps.	2	6/box	24276-06
Sample Cells, 1-inch square, 10 mL, matched pair	2	2/pkg	24954-02
Wipers, disposable, KimWipes®	varies	280/pkg	20970-00

Recommended Standards

Description	Unit	Cat. No.
Chloroform, 10-ppm ampule	each	27567-07
Water, Reagent, Organic-free	500 mL	26415-49

Recommended Apparatus

Description	Unit	Cat. No.
Flask, volumetric, 100 mL, class A	.each	14574-42
Pipet, filler, safety bulb	each	14651-00
Pipet, volumetric, class A, 10 mL	each	14515-38
Pipettes, Wiretrol™, 50–100 µL	250/pkg	25689-05
Repipet Jr., 1-mL	each	21113-02
Vials, glass, 40-mL, with Septa cap	5/pkg	27940-05



FOR TECHNICAL ASSISTANCE, PRICE INFORMATION AND ORDERING:

In the U.S.A. – Call toll-free 800-227-4224
Outside the U.S.A. – Contact the HACH office or distributor serving you.
On the Worldwide Web – www.hach.com; E-mail – techhelp@hach.com

HACH COMPANY
WORLD HEADQUARTERS
Telephone: (970) 669-3050
FAX: (970) 669-2932

Volatile Acids

Method 8196

Esterification Method¹

Powder Pillows

(27 to 2800 mg/L)

Scope and Application: For digester sludges

¹ Adapted from *The Analyst*, 87, 949 (1962)



Test Preparation

Collect the following items:

Quantity

Centrifuge	1
Centrifuge Tubes and Caps	2
Cylinder, 10-mL graduated	1
Ethylene Glycol	3 mL
Ferric Chloride-Sulfuric Acid Solution	20 mL
Funnel and Filter Paper	—
Hot Plate	1
Hydroxylamine Hydrochloride Solution, 100-g/L	1 mL
Pipet Filler	1
Pipet, 2 mL	1
Pipet, volumetric, Class A, 0.50-mL	1
Pipet, volumetric, Class A, 10-mL	1
Sample Cells, 10-20-25 mL	2
Sample Cells, 1-inch square glass	2
Sodium Hydroxide Standard Solution, 4.5 N	4 mL
Sulfuric Acid Standard Solution, 19.2 N	0.4 mL
Water Bath and Rack	1
Water, deionized	20.5 mL

Note: Reorder information for consumables and replacement items is on page 5.

Esterification

Method 8196

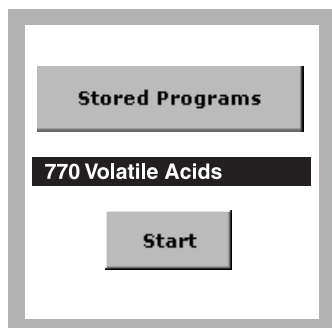

1. Select the test.

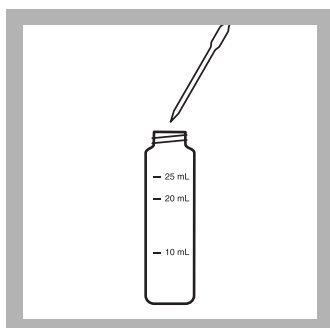

2. **Blank Preparation:**
Pipet 0.5 mL of deionized water into a dry 25-mL sample cell.

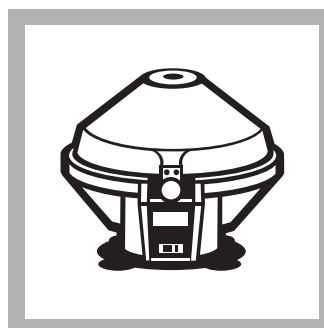

3. Filter or centrifuge 25 mL of sample. Centrifuging is faster than filtration.

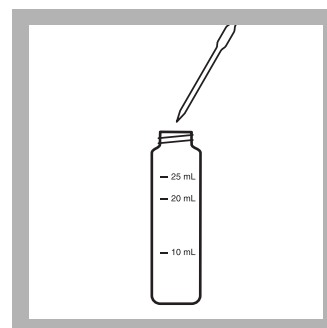

4. **Prepared Sample:**
Pipet 0.5 mL of the filtrate or supernatant into a second dry 25-mL sample cell.

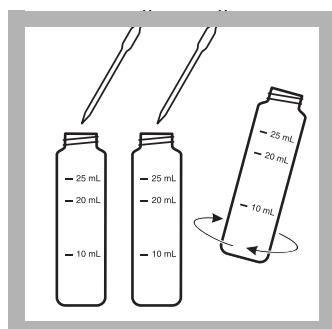

5. Pipet 1.5 mL of ethylene glycol into each sample cell. Swirl to mix.

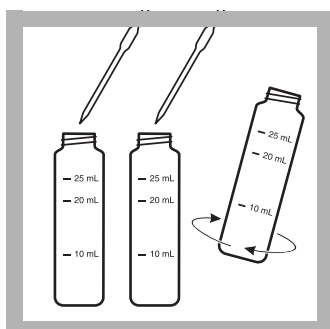

6. Pipet 0.2 mL of 19.2 N Sulfuric Acid Standard Solution into each cell. Swirl to mix.



7. Insert both cells into a boiling water bath. Alternatively, the cells may be boiled in a 500-mL beaker.

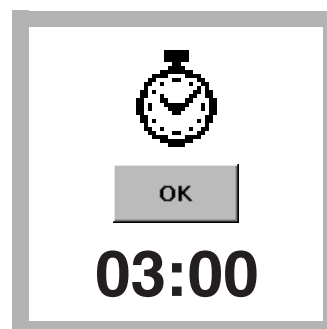

8. Press **TIMER>OK**. A three-minute reaction period will begin.

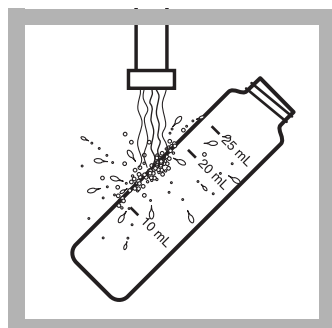

9. When the timer expires, cool the solutions to 25 °C (until the cell feels cold) with running tap water.

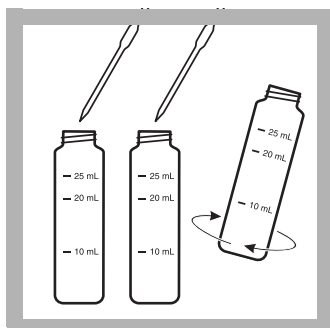

10. Using a pipet filler, pipet 0.5 mL of Hydroxylamine Hydrochloride Solution into each cell. Swirl to mix.

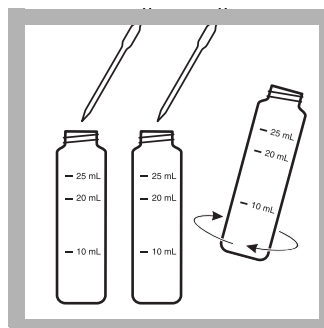

11. Using a pipet filler, pipet 2.0 mL of 4.5 N Sodium Hydroxide Standard Solution into each cell. Swirl to mix.

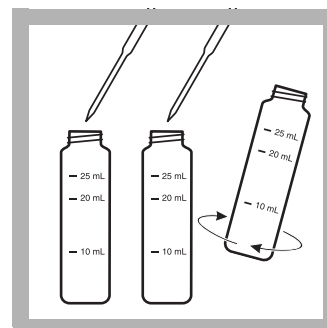

12. Add 10 mL of Ferric Chloride Sulfuric Acid Solution to each cell. Swirl to mix.

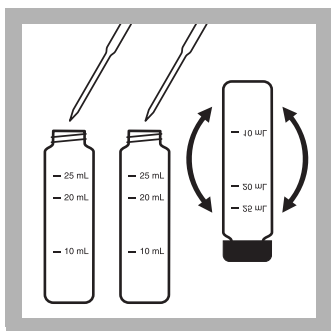

13. Add 10 mL of deionized water to each cell. Cap and invert to mix.

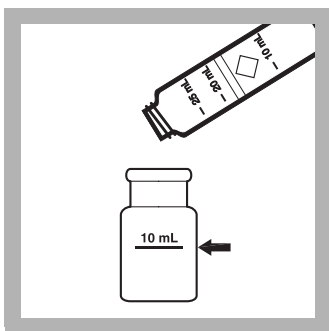

14. Transfer 10 mL of the blank solution from the round 25-mL cell to a clean dry square sample cell.

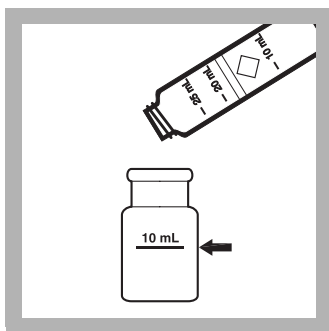

15. Transfer 10-mL of the sample solution from the round 25-mL cell to a clean dry square sample cell.

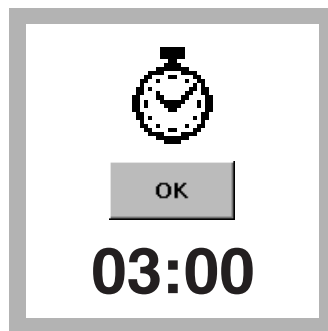

16. Immediately press **TIMER>OK**.

Another three-minute reaction period will begin. During this time, complete steps 17 and 18.



17. Blot each sample cell dry. Immediately insert the blank into the cell holder with the fill line facing right.

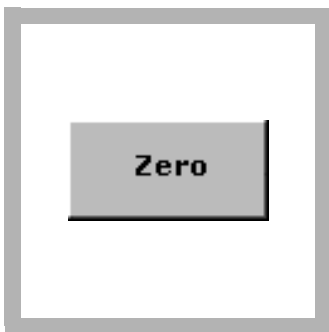

18. Press **ZERO**.
The display will show:
0 mg/L HOAC



19. Wipe the prepared sample and insert it into the cell holder with the fill line facing right.

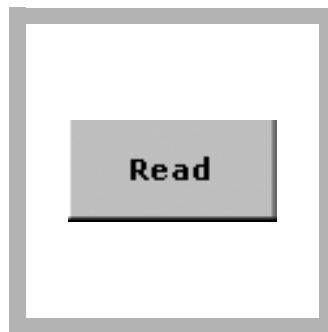

20. Press **READ**.
Results are in mg/L HOAC.

Sample Collection, Preservation, and Storage

Collect samples in clean plastic or glass bottles. Analyze as soon as possible after collection. Samples can be stored for up to 24 hours by cooling to 4 °C (40 °F) or below. Warm samples to room temperature before analysis.

Accuracy Check

Standard Additions Method (Sample Spike)

1. After reading test results, leave the sample cell (unspiked sample) in the instrument.
2. Press **OPTIONS>MORE**. Press **STANDARD ADDITIONS**. A summary of the standard additions procedure will appear.
3. Press **OK** to accept the default values for standard concentration, sample volume, and spike volumes. Press **EDIT** to change these values. After values are accepted, the unspiked sample reading will appear in the top row. See the user manual for more information.

4. Snap the neck off a Volatile Acid Voluette® Ampule Standard, 62,500-mg/L as acetic acid.
5. Prepare three sample spikes. Fill three Mixing Cylinders* with 25 mL of sample. Use the TenSette® Pipet to add 0.1 mL, 0.2 mL, and 0.3 mL of standard, respectively, to each sample and mix thoroughly.
6. Analyze each sample spike as described in the procedure above, starting with the 0.1 mL sample spike. Accept each standard additions reading by pressing **READ**. Each addition should reflect approximately 100% recovery.
7. After completing the sequence, press **GRAPH** to view the best-fit line through the standard additions data points, accounting for matrix interferences. Press **IDEAL LINE** to view the relationship between the sample spikes and the "Ideal Line" of 100% recovery.

Standard Solution Method

Prepare a 500 mg/L volatile acid standard solution as follows:

1. Pipet 4.00 mL of a 62,500-mg/L Volatile Acid Standard Solution into a 500-mL Class A volumetric flask. Dilute to volume with deionized water. Prepare this solution daily. Perform the esterification procedure as described above.
2. To adjust the calibration curve using the reading obtained with the standard solution, press **OPTIONS>MORE** on the current program menu. Press **STANDARD ADJUST**.
3. Press **ON**. Press **OK** to accept the displayed concentration. If an alternate concentration is used, press the number in the **ADJUST TO** field and enter the actual concentration. Press **OK**. Press **ADJUST**.

Summary of Method

The volatile acid test is designed specifically for determining volatile acids in digester sludges. The method is based on esterification of the carboxylic acids present in the sample and subsequent determination of the esters by the ferric hydroxamate reaction. All volatile acids present are reported as their equivalent mg/L as acetic acid. Test results are measured at 495 nm.

* See [Optional Reagents and Apparatus on page 5](#).

Consumables and Replacement Items

Required Reagents

Description	Quantity/Test	Unit	Cat. No.
Volatile Acid Reagent Set (90 tests), includes:			22447-00
(1) Ethylene Glycol	3 mL	1000 mL	2039-53
(2) Ferric Chloride-Sulfuric Acid Solution	20 mL	1000 mL	2042-53
(1) Hydroxylamine Hydrochloride Solution, 100-g/L	1 mL	100 mL	818-42
(1) Sodium Hydroxide Standard Solution, 4.5 N	4 mL	1000 mL	2040-53
(1) Sulfuric Acid Standard Solution, 19.2 N	0.4 mL	100 mL MDB	2038-32
Water, deionized	20.5 mL	4 L	272-56

Required Apparatus

Description	Quantity/Test	Unit	Cat. No.
Centrifuge, 115 VAC, 60 Hz.	1	each	26765-00
Centrifuge Tubes, 15-mL	2	10/pkg	22787-39
Centrifuge Tube Caps	2	20/pkg	25852-20
Cylinder, graduated, 10-mL	1	each	508-38
Filter Paper, folded, 12.5-cm	1	100/pkg	1894-57
Funnel, poly, 65-mm	1	each	1083-67
Hot Plate, 4-inch micro, 120 VAC	1	each	12067-01
Hot Plate, 4-inch micro, 240 VAC	1	each	12067-02
Pipet Filler, safety bulb	1	each	14651-00
Pipet, serological, 2-mL	1	each	532-36
Pipet, volumetric, Class A, 0.50-mL	1	each	14515-34
Pipet, volumetric, Class A, 10.00-mL	1	each	14515-38
Sample Cells, 10-20-25 mL, with cap	2	6/pkg	24019-06
Sample Cells, 1-inch square, 10 mL, matched pair	2	2/pkg	24954-02
Water Bath and Rack	1	each	1955-55

Recommended Standards

Description	Unit	Cat. No.
Volatile Acids Standard Solution, 10-mL Voluette® Ampule, 62,500-mg/L as HOAC	16/pkg	14270-10

Optional Reagents and Apparatus

Description	Cat. No.
Cylinder, mixing	1896-40



FOR TECHNICAL ASSISTANCE, PRICE INFORMATION AND ORDERING:

In the U.S.A. – Call toll-free 800-227-4224
Outside the U.S.A. – Contact the HACH office or distributor serving you.
On the Worldwide Web – www.hach.com; E-mail – techhelp@hach.com

HACH COMPANY
WORLD HEADQUARTERS
Telephone: (970) 669-3050
FAX: (970) 669-2932

Method 8009

Zincon Method¹

Powder Pillows

(0.01 to 3.00 mg/L)

Scope and Application: For water and wastewater; digestion is required for determining total zinc (see [Digestion on page 4](#)); USEPA Approved for wastewater analyses²

¹ Adapted from *Standard Methods for the Examination of Water and Wastewater*.

² Federal Register, 45(105) 36166 (May 29, 1980).



Test Preparation

Before starting the test:

Use only glass-stoppered cylinders in this procedure.

Wash glassware with 1:1 HCl¹ and rinse with deionized water before use.

Use plastic droppers in this procedure. Droppers with rubber bulbs may contaminate the reagent.

ZincoVer® 5 reagent contains potassium cyanide. Cyanide solutions are regulated as hazardous wastes by the Federal RCRA. Cyanide should be collected for disposal as a reactive (D003) waste. Be sure that cyanide solutions are stored in a caustic solution with pH >11 to prevent release of hydrogen cyanide gas. Refer to the current MSDS for handling and disposal information.

¹ See [Optional Reagents and Apparatus on page 5](#).

Collect the following items:

Quantity

Zinc Reagent Set:	
Cyclohexanone	0.5 mL
ZincoVer 5 Reagent Powder Pillow	1
Cylinder, graduated mixing, 25-mL	1
Sample Cells, 1-inch square glass, 10 mL	2

Note: Reorder information for consumables and replacement items is on [page 5](#).

Powder Pillows

Method 8009

CAUTION

ZincoVer 5 Reagent contains cyanide and is very poisonous if taken internally or if fumes are inhaled. Do not add to an acidic sample (pH < 4).



1. Press **STORED PROGRAMS**.



2. Select the test.

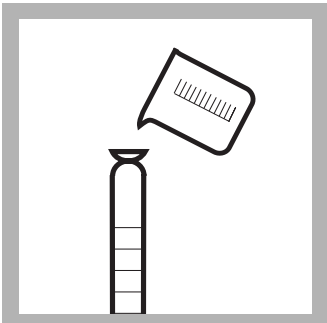

3. Fill a 25-mL graduated mixing cylinder with 20 mL of sample.

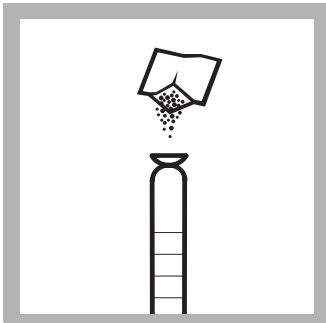

4. Add the contents of one ZincoVer 5 Reagent Powder Pillow to the cylinder. Stopper.

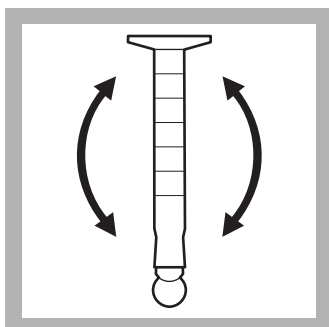

5. Invert several times to dissolve the powder completely. Inconsistent readings may result for low zinc concentrations if all the particles are not dissolved.

The sample should be orange. If the sample is brown or blue, either the zinc concentration is too high, or an interfering metal is present. Dilute the sample and repeat the test.

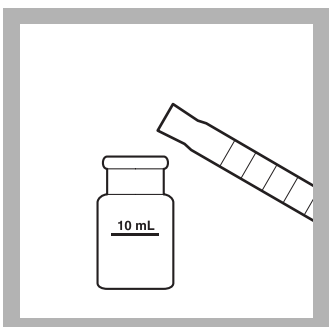

6. **Blank Preparation:** Pour 10 mL of the solution into a square sample cell.

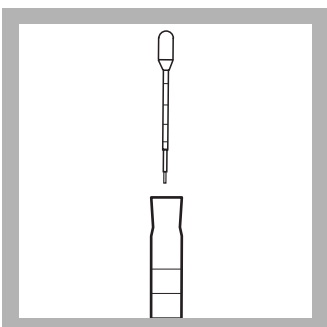

7. **Prepared Sample:** Use a plastic dropper to add 0.5 mL of cyclohexanone to the remaining solution in the graduated cylinder.



8. Press **TIMER>OK**. A 30-second reaction period will begin.

During the reaction period, stopper the cylinder and vigorously shake the prepared sample.

The sample will be reddish-orange, brown, or blue, depending on the zinc concentration.

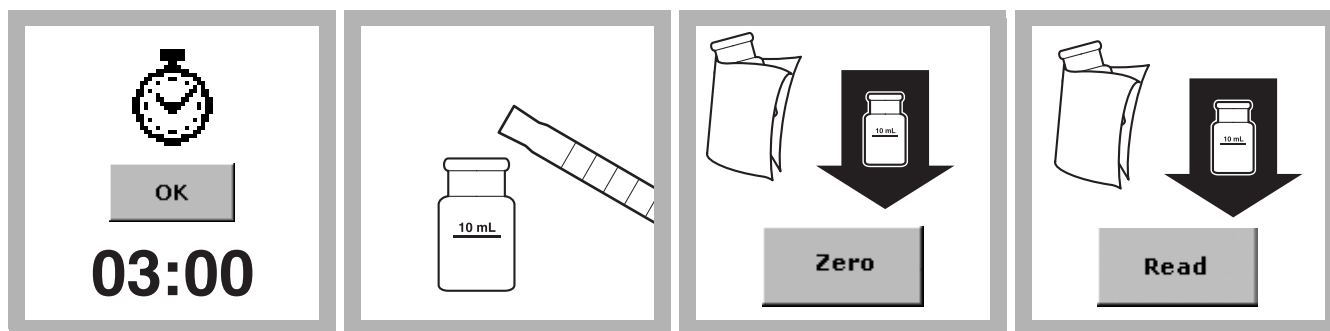
**9. Press TIMER>OK.**

A three-minute reaction period will begin. During this reaction period, complete step 10.

10. Pour the prepared sample solution from the cylinder into a second square sample cell.**11. When the timer expires, wipe the blank and insert it into the cell holder with the fill line facing right.**

Press **ZERO**. The display will show:

0.00 mg/L Zn

12. Wipe the prepared sample and insert it into the cell holder with the fill line facing right.

Press **READ**. Results are in mg/L Zn.

Interferences

Table 1 Interfering Substances and Levels

Interfering Substance	Interference Levels and Treatments
Aluminum	Greater than 6 mg/L
Cadmium	Greater than 0.5 mg/L
Copper	Greater than 5 mg/L
Iron (ferric)	Greater than 7 mg/L
Manganese	Greater than 5 mg/L
Nickel	Greater than 5 mg/L
Organic Material	Large amounts may interfere. Pretreat the sample with a mild digestion.
Highly buffered or extreme sample pH	May exceed the buffering capacity of the reagents and require sample pretreatment. Adjust pH to 4–5.

Samples containing amino-tri(methylene phosphonic acid) (AMP) will exhibit a negative interference. Perform a total phosphorus digestion (Method 8190) to eliminate this interference.

Important Note: Adjust the pH of the sample after the total phosphorus digestion to 4–5 with Sodium Hydroxide before analysis with the zinc test.

Sample Collection, Storage, and Preservation

Collect samples in acid-cleaned plastic or glass bottles. If prompt analysis is impossible, preserve the sample by adjusting to pH 2 or less with nitric acid (about 2 mL per liter). Preserved samples may be stored up to six months at room temperature.

Before analysis, adjust the pH to 4–5 with 5.0 N Sodium Hydroxide. Do not exceed pH 5 as zinc may precipitate. Correct the test result for volume additions.

Accuracy Check

1. After reading test results, leave the sample cell (unspiked sample) in the instrument.
2. Press **OPTIONS**. Press **STANDARD ADDITIONS**. A summary of the standard additions procedure will appear.
3. Press **OK** to accept the default values for standard concentration, sample volume, and spike volumes. Press **EDIT** to change these values. After values are accepted, the unspiked sample reading will appear in the top row. See the user manual for more information.
4. Snap the neck off a Zinc Voluette[®] Ampule Standard, 25-mg/L Zn.
5. Prepare three sample spikes. Fill three mixing cylinders* with 20 mL of sample and use the TenSette[®] Pipet to add 0.1 mL, 0.2 mL, and 0.3 mL of standard, respectively to each sample and mix thoroughly.
6. Analyze each sample spike as described in the procedure above, starting with the 0.1 mL sample spike. Accept each standard additions reading by pressing **READ**. Each addition should reflect approximately 100% recovery.
7. After completing the sequence, press **GRAPH** to view the best-fit line through the standard additions data points, accounting for matrix interferences. Press **IDEAL LINE** to view relationships between the sample spikes and the "Ideal Line" of 100% recovery.

Standard Solution Method

Prepare a 1.00-mg/L zinc standard solution as follows:

1. Using Class A glassware, pipet 10.00 mL of Zinc Standard Solution, 100-mg/L, into a 1000-mL volumetric flask. Dilute to the mark with deionized water. Prepare this solution daily. Perform the Zinc procedure as described above.
2. To adjust the calibration curve using the reading obtained with the standard solution, press **OPTIONS>MORE** on the current program menu. Press **STANDARD ADJUST**.
3. Press **ON**. Press **ADJUST** to accept the displayed concentration. If an alternate concentration is used, press the number in the box to enter the actual concentration, then press **OK**. Press **ADJUST**.

Digestion

Digestion is required if total zinc is being determined. The following is not the USEPA digestion.

1. If nitric acid has not been added to the sample previously, add 5 mL of Concentrated Nitric Acid* to one liter of sample (use a glass serological pipet and pipet filler). If the sample was acidified at collection, add 3 mL of nitric acid to one liter of sample.
2. Transfer 100 mL of acidified sample to a 250-mL Erlenmeyer flask.
3. Add 5 mL of 1:1 Hydrochloric Acid*.
4. Heat sample on a Hot Plate* for 15 minutes at 95 °C (203 °F). Make sure the sample does not boil.

* See [Optional Reagents and Apparatus on page 5](#).

5. Filter cooled sample through a membrane filter and adjust the volume to 100 mL with Deionized Water.
6. Adjust the pH to 4–5 with 5.0 N Sodium Hydroxide* before analysis. See [Sample Collection, Storage, and Preservation on page 3](#) for instructions.

Summary of Method

Zinc and other metals in the sample are complexed with cyanide. Adding cyclohexanone causes a selective release of zinc. The zinc reacts with 2-carboxy-2'-hydroxy-5'-sulfoformazyl benzene (zincon) indicator to form a blue-colored species. The blue color is masked by the brown color from the excess indicator. The intensity of the blue color is proportional to the amount of zinc present. Test results are measured at 620 nm.

Consumables and Replacement Items

Required Reagents

Description	Quantity/Test	Unit	Cat. No.
Zinc Reagent Set, 20-mL sample size (100 tests = 100 samples + 100 blanks), includes:	—	—	24293-00
Cyclohexanone	—	100 mL MDB	14033-32
ZincoVer® 5 Reagent Powder Pillows	1	100/pkg	21066-69

Required Apparatus

Description	Quantity/Test	Unit	Cat. No.
Cylinder, graduated, mixing, 25-mL	1	each	20886-40
Sample Cells, 1-inch square, 10 mL, matched pair	2	2/pkg	24954-02

Recommended Standards

Description	Unit	Cat. No.
Water, deionized	4 L	272-56
Zinc Standard Solution, 100-mg/L	100 mL	2378-42
Zinc Standard Solution, 2-mg/L PourRite® Ampule, 25-mg/L as Zn	20/pkg	14246-20
Zinc Standard Solution, 10-mg/L Voluette® Ampule, 25-mg/L as Zn	16/pkg	14246-10

Optional Reagents and Apparatus

Description	Cat. No.
Flask, Erlenmeyer, 250 mL	505-46
Hot Plate, 115 V	12067-01
Hot Plate, 220 V	12067-02
Hydrochloric Acid 6.0 N, 1:1	884-49
Nitric Acid, concentrated	152-49
Sodium Hydroxide 5.0 N	2450-26

* See [Optional Reagents and Apparatus on page 5](#).



FOR TECHNICAL ASSISTANCE, PRICE INFORMATION AND ORDERING:

In the U.S.A. – Call toll-free 800-227-4224
Outside the U.S.A. – Contact the HACH office or distributor serving you.
On the Worldwide Web – www.hach.com; E-mail – techhelp@hach.com

HACH COMPANY
WORLD HEADQUARTERS
Telephone: (970) 669-3050
FAX: (970) 669-2932