



XLD

Laser Detectors

Users Manual

December 2018

© 2018 Fluke Corporation. All rights reserved. Specifications are subject to change without notice.
All product names are trademarks of their respective companies.

LIMITED WARRANTY AND LIMITATION OF LIABILITY

This Fluke product will be free from defects in material and workmanship for three years from the date of purchase. This warranty does not cover fuses, disposable batteries, or damage from accident, neglect, misuse, alteration, contamination, or abnormal conditions of operation or handling. Resellers are not authorized to extend any other warranty on Fluke's behalf. To obtain service during the warranty period, contact your nearest Fluke authorized service center to obtain return authorization information, then send the product to that Service Center with a description of the problem.

THIS WARRANTY IS YOUR ONLY REMEDY. NO OTHER WARRANTIES, SUCH AS FITNESS FOR A PARTICULAR PURPOSE, ARE EXPRESSED OR IMPLIED. FLUKE IS NOT LIABLE FOR ANY SPECIAL, INDIRECT, INCIDENTAL OR CONSEQUENTIAL DAMAGES OR LOSSES, ARISING FROM ANY CAUSE OR THEORY. Since some states or countries do not allow the exclusion or limitation of an implied warranty or of incidental or consequential damages, this limitation of liability may not apply to you.

Fluke Corporation
P.O. Box 9090
Everett, WA 98206-9090
U.S.A.

Fluke Europe B.V.
P.O. Box 1186
5602 BD Eindhoven
The Netherlands

ООО «Флюк СИИЭС»
125167, г. Москва,
Ленинградский проспект дом 37,
корпус 9, подъезд 4, 1 этаж

Table of Contents

Title	Page
Introduction	1
How to Contact Fluke.....	1
Safety Information.....	1
Product Familiarization	3
Features.....	3
Display	4
Control Panel.....	5
Detection Accuracy.....	6
On Grade Measurements	6
Attach Rod Clamp.....	6
Take Measurements	7
Maintenance	8
Clean the Product	8
Batteries.....	9
Specifications.....	9

Introduction

The XLD Rotary Laser Detector (the Detector or Product) senses red and green laser beams that may be difficult to see with the human eye. The Detector is battery-powered and very portable. Use the Detector with the rod clamp, a grade rod, and a red or green rotary laser level to identify new level and grade marks.

How to Contact Fluke

To contact Fluke, call one of the following telephone numbers:

- Technical Support USA: 1-800-44-FLUKE (1-800-443-5853)
- Calibration/Repair USA: 1-888-99-FLUKE (1-888-993-5853)
- Canada: 1-800-36-FLUKE (1-800-363-5853)
- Europe: +31 402-675-200
- Japan: +81-3-6714-3114
- Singapore: +65-6799-5566
- China: +86-400-921-0835
- Brazil: +55-11-3530-8901
- Anywhere in the world: +1-425-446-5500

Or, visit the PLS website at www.plslaser.com.

To view, print, or download the latest manual supplement, visit www.plslaser.com.

Safety Information

A **Warning** identifies conditions and actions that pose hazards to the user; a **Caution** identifies conditions and actions that may damage the Product or the equipment under test.

Warning









To prevent eye damage and personal injury:

- **Read all safety information before you use the Product.**
- **Carefully read all instructions.**
- **Do not alter the Product and use only as specified, or the protection supplied by the Product can be compromised.**
- **Do not use the Product if it operates incorrectly.**
- **Do not use the Product if it is altered or damaged.**

- Batteries contain hazardous chemicals that can cause burns or explode. If exposure to chemicals occurs, clean with water and get medical aid.
- Do not disassemble the battery.
- Repair the Product before use if the battery leaks.
- The battery door must be closed and locked before you operate the Product.
- Remove the batteries if the Product is not used for an extended period of time, or if stored in temperatures above 50 °C. If the batteries are not removed, battery leakage can damage the Product.
- Replace the batteries when the low battery indicator shows to prevent incorrect measurements.
- Be sure that the battery polarity is correct to prevent battery leakage.
- Use only Fluke approved power adapters to charge the battery.
- Do not short the battery terminals together.
- Do not disassemble or crush battery cells and battery packs.
- Do not keep cells or batteries in a container where the terminals can be shorted.
- Do not put battery cells and battery packs near heat or fire. Do not put in sunlight.

Table 1 is a list of the symbols that can be used on the Product or in this manual.

Table 1. Symbols

Symbol	Description	Symbol	Description
	Consult user documentation.		Low battery indicator.
	WARNING. RISK OF DANGER		Battery or battery compartment.
	Conforms to European Union directives.		
	Conforms to relevant Australian Safety and EMC standards.		
	Conforms to relevant South Korean EMC Standards.		
	This product complies with the WEEE Directive marking requirements. The affixed label indicates that you must not discard this electrical/electronic product in domestic household waste. Product Category: With reference to the equipment types in the WEEE Directive Annex I, this product is classed as category 9 "Monitoring and Control Instrumentation" product. Do not dispose of this product as unsorted municipal waste.		

Product Familiarization

Features

Table 2 shows the features of the Product.

Table 2. Features

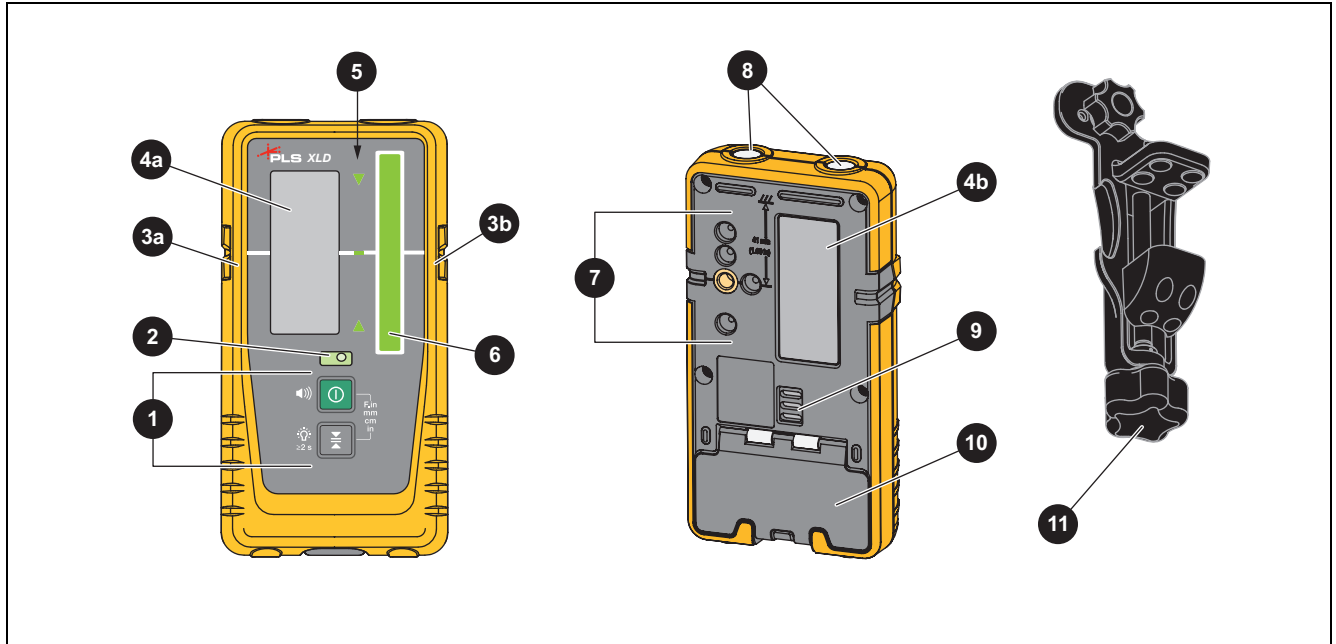

Item	Description	Function
1	Control panel	Multiple functions. See Control Panel .
2	Bubble level	Shows the horizontal position of the Product.
3	On grade offset notch	Use to transfer reference marks 41 mm from the top edge of the detector.
4	Display	See Display .
5	Grade indicator LEDs	Indicates when the detector is too high, too low, or on grade.
6	Laser beam reception window	Detects a laser beam when faced towards a laser.
7	Rod clamp guides and screw thread	Use to attach the clamp to the Detector.
8	Magnets	Use to attach the Detector to a magnetic metal surface.
9	Beeper speaker	Emits sound when the beeper is activated.
10	Battery door	Secures the battery.
11	Rod clamp	Secures the clamp to the Detector and a measuring rod or staff.

Display

Table 3 shows the items on the display.



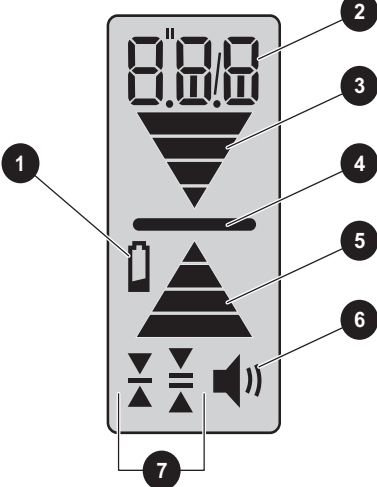
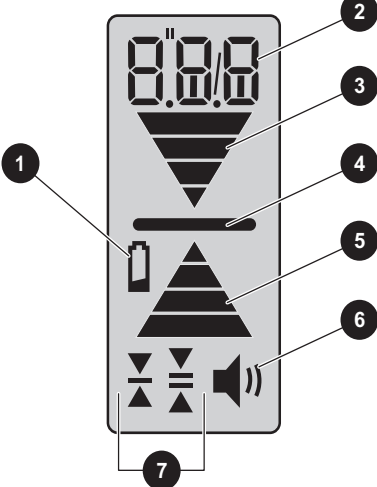
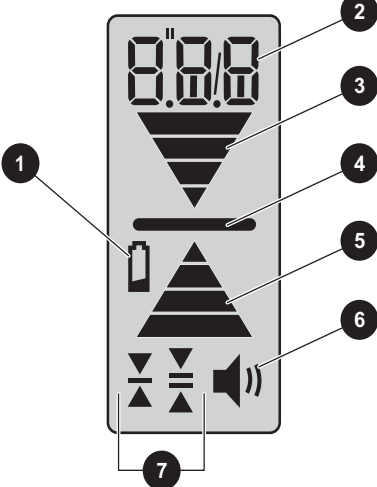
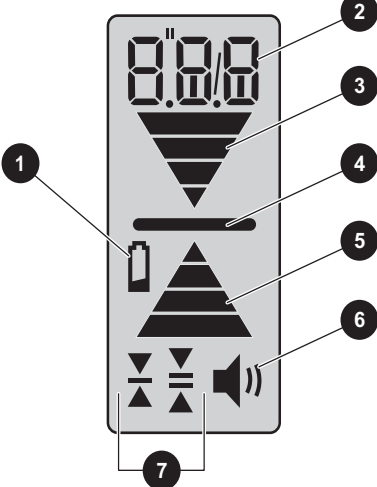
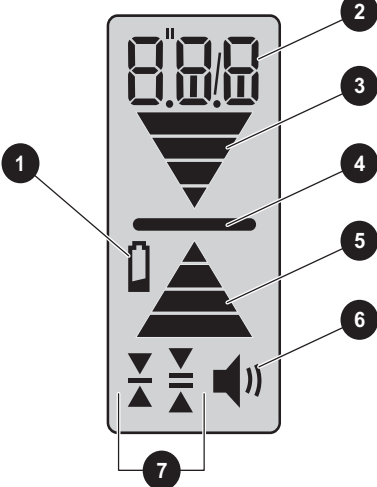
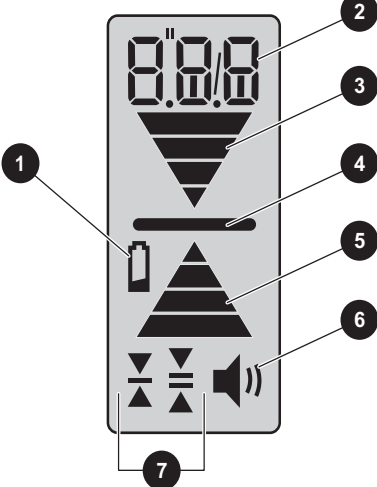
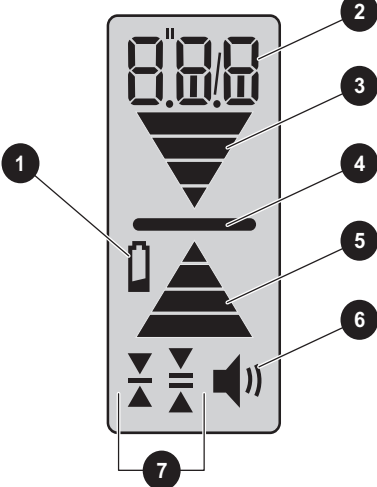





Table 3. Display

	Item	Description
	1	Battery level status
	2	Numeric or text display
	3	High grade arrows. Shows when the detector is too high and needs to be lowered.
	4	On grade indicator
	5	Low grade arrows. Shows when the detector is too low and needs to be raised.
	6	Beeper on or off status
	7	Laser beam detection accuracy status. See Detection Accuracy .

Control Panel

Table 4 lists the functions of buttons on the control panel.

Table 4. Control Panel

Description	Function
Power	<p>Push  once to turn on the Product.</p> <p>Push and hold  for ≥ 2 seconds to turn off the Product.</p>
Detection accuracy	<p>Push  once to view the current detection accuracy setting and units of measure.</p> <p>Push  twice quickly to change the detection accuracy setting. For available options, see Detection Accuracy.</p> <p>The detection accuracy numerical value and units of measure briefly show at the top of the display.</p>
Detection units of measure	<p>Push  +  at the same time to change the units of measure. For available options, see Detection Accuracy.</p> <p>The detection accuracy numerical value and unit of measure briefly show at the top of the display.</p>
Beeper volume	<p>With the Product on, push  to select the beeper volume. You can select Low, Hi, or OFF.</p> <p>The volume level briefly shows at the top of the display.</p> <p> shows on the bottom of the display when the beeper volume is set to Low or Hi.</p>
Grade indicator LEDs	<p>Push and hold  for ≥ 2 seconds to turn on or turn off the grade indicator lights.</p> <p>All three grade indicator lights flash briefly.</p> <p>With the grade indicator lights enabled, when the laser beam reception window detects a laser beam:</p> <p>The top LED lights when the Detector is too high and needs to be lowered.</p> <p>The bottom LED lights when the Detector is too low and needs to be raised.</p> <p>The middle LED lights when the Detector is on grade.</p>

Detection Accuracy

You can set the detection accuracy and units of measure. The numerical value of the detection accuracy depends on the measurement units. See Table 5.

Table 5. Detection Accuracy

	Fine	Medium	Course
	$\frac{\nabla}{\blacktriangle}$	$\frac{\nabla}{\blacktriangle} \frac{\nabla}{\blacktriangle}$	$\frac{\nabla}{\blacktriangle}$
Fractional inches (F.in)	1/8	1/4	1/2
Millimeters (mm)	1.0	2.0	5.0
Centimeters (cm)	0.1	0.2	0.5
Inches (in)	0.05	0.1	0.2

On Grade Measurements

Use the Detector with the rod clamp, a grade rod, and a red or green rotary laser level to identify new level and grade marks.

Attach Rod Clamp

Table 6 shows the features of the rod clamp.

Table 6. Rod Clamp

Item	Description	Function
1	Alignment points	Use to secure and align the rod clamp to the Detector.
2	Rod clamp screw	Turn clockwise to attach the clamp to the Detector.
3	Reference indicators	Align with the on-grade marks on the Detector for grade rod readings.
4	Clamp screw knob	Secures the clamp to a measuring rod or staff.

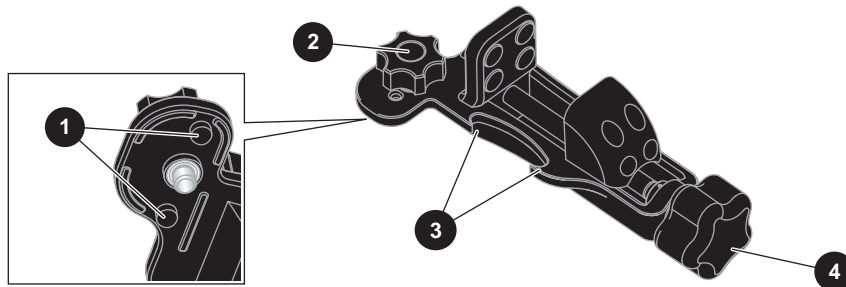

Figure 1 shows how to connect the rod clamp to the Detector and a grade rod, measuring rod, or staff.

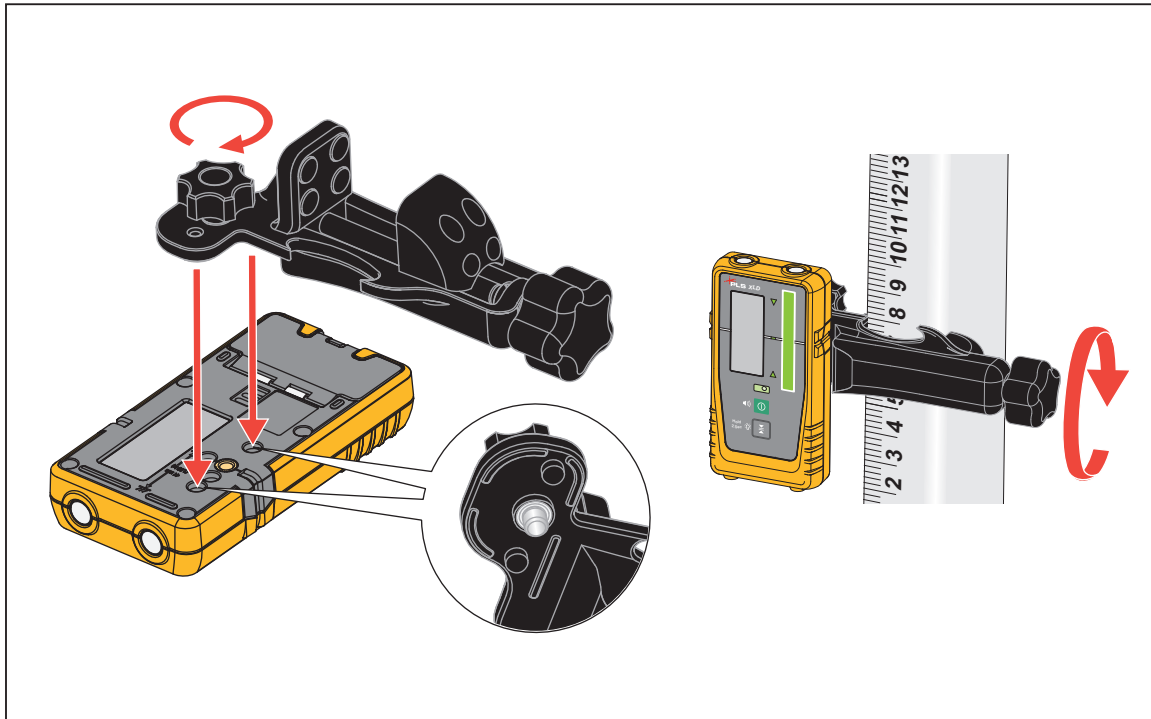

Figure 1. Rod Clamp Attachment

Take Measurements

To identify new level and grade marks:

1. Put the bottom of the laser level on a stable surface or tripod.
2. Connect the rod clamp to the Detector and a grade rod, measuring rod, or staff. See Figure 1.
3. Turn on the laser level and the Detector and direct the laser beam toward the laser reception window of the Detector. See Figure 2.
4. Move the Detector up and down the rod until the laser level on the display indicates the Detector is level with the laser beam. See Figure 2.

The number of segments of the arrows on the display decreases as the Detector gets closer to on grade.

The numerical reading shows on the display. The numerical reading decreases as the Detector gets closer to on grade.

If the beeper is on, the Detector emits a solid output signal when the Detector is level with the laser beam.

If the grade indicator lights are on, the appropriate grade indicator light turns on to indicate the position of the Detector in relationship to the laser beam.

5. Secure the Detector to the rod and take measurements as needed.

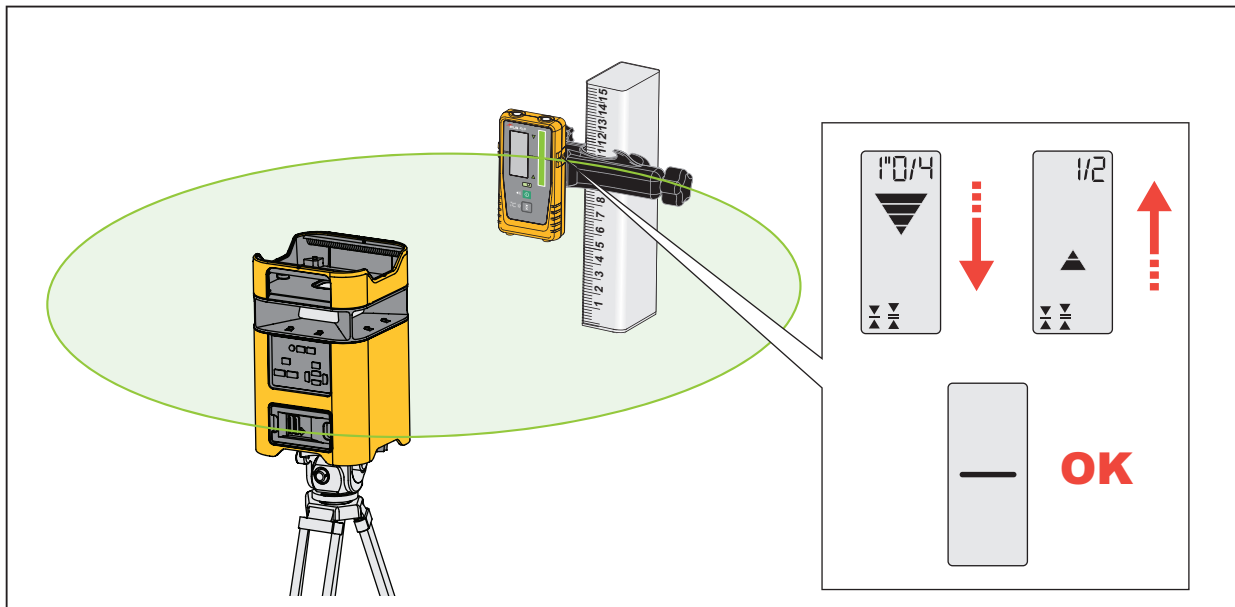

Figure 2. Level and Detector

Maintenance

To maintain the Product, clean the case, front and rear displays, and laser beam reception window and replace the battery.

⚠ Caution

To prevent damage to the Product, do not drop the Product. Treat the Product as a calibrated instrument.

Clean the Product

⚠ Caution

To prevent damage to the Product, do not use abrasives, isopropyl alcohol, or solvents to clean the Product.

Clean the case with a damp cloth and a weak soap solution.

To clean the front display, rear display, and the laser beam reception window, use a pressurized can of air or a dry nitrogen-ion gun, if available, to blow off particulates from the surfaces.

Batteries

Replace the battery when the battery indicator shows a low battery.

To install or replace the battery (See Figure 3.):

1. Open the battery door.
2. Install one AA battery with the correct polarity.
3. Close the battery door.

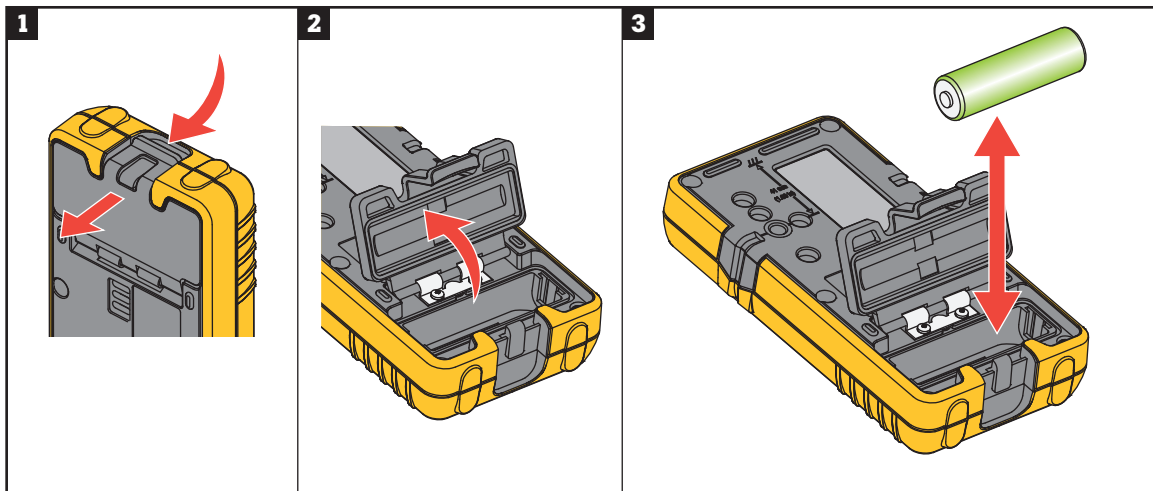

Figure 3. Battery Replacement

Specifications

Capture height	60 mm (2.4 in)
Numeric readout height	50 mm (2.0 in)
Reception angle	±45 °
Detectable spectrum	450 nm to 800 nm (blue, green, red, NIR)
Working radius	300 m (984 ft), depending on the laser level
Beeper volume	
Off	0 dBA
Low	≥75 dBA
High	≥100 dBA
Automatic shutoff	30 min without use or laser detection
Internal filter against	Flash, sunlight, LED, fluorescent lamps
Marking notch	41 mm from top edge
Size (H x W x L)	135 mm x 69 mm x 25 mm (5.3 in x 2.7 in x 1.0 in)
Weight without clamp	~0.19 kg (0.42 lb)
Battery	1 x AA Alkaline IEC LR6
Battery life, continuous use	≥50 hours

Temperature	
Operating	-20 °C to 50 °C (-4 °F to 122 °F)
Storage	
With Batteries	-18 °C to 50 °C (-0.4 °F to 122 °F)
Without Batteries	-40 °C to 70 °C (-40 °F to 158 °F)
Relative humidity	0 % to 90 % (0 °C to 35 °C) 0 % to 75 % (35 °C to 40 °C) 0 % to 45 % (40 °C to 50 °C)
Drop test	1 m
Safety	IEC 61010-1: Pollution Degree 2
Ingress Protection Rating	IP67
Electromagnetic Compatibility (EMC)	
International	IEC 61326-1: Basic Electromagnetic Environment, CISPR 11: Group 1, Class B <i>Group 1: Equipment has intentionally generated and/or uses conductively-coupled radio frequency energy that is necessary for the internal function of the equipment itself.</i> <i>Class B: Equipment is suitable for use in domestic establishments and in establishments directly connected to a low voltage power supply network which supplies buildings used for domestic purposes.</i> <i>Emissions that exceed the levels required by CISPR 11 can occur when the equipment is connected to a test object</i>
Korea (KCC)	Class B Equipment (Broadcast communications equipment for home)
USA (FCC)	47 CFR 15 subpart B. This product is considered an exempt device per clause 15.103.