

Power Clamp-On Meter Model 606



CLAMP-ON METERS



Copyright© Chauvin Arnoux®, Inc. d.b.a. AEMC® Instruments. All rights reserved.

No part of this documentation may be reproduced in any form or by any means (including electronic storage and retrieval or translation into any other language) without prior agreement and written consent from Chauvin Arnoux®, Inc., as governed by United States and International copyright laws.

Chauvin Arnoux®, Inc. d.b.a. AEMC® Instruments
15 Faraday Drive • Dover, NH 03820 USA
Phone: (603) 749-6434 or (800) 343-1391 • Fax: (603) 742-2346

This documentation is provided **as is**, without warranty of any kind, express, implied, or otherwise. Chauvin Arnoux®, Inc. has made every reasonable effort to ensure that this documentation is accurate; but does not warrant the accuracy or completeness of the text, graphics, or other information contained in this documentation. Chauvin Arnoux®, Inc. shall not be liable for any damages, special, indirect, incidental, or inconsequential; including (but not limited to) physical, emotional or monetary damages due to lost revenues or lost profits that may result from the use of this documentation, whether or not the user of the documentation has been advised of the possibility of such damages.

Statement of Compliance

Chauvin Arnoux[®], Inc. d.b.a. AEMC[®] Instruments certifies that this instrument has been calibrated using standards and instruments traceable to international standards.

We guarantee that at the time of shipping your instrument has met the instrument's published specifications.

An NIST traceable certificate may be requested at the time of purchase, or obtained by returning the instrument to our repair and calibration facility, for a nominal charge.

The recommended calibration interval for this instrument is 12 months and begins on the date of receipt by the customer. For recalibration, please use our calibration services. Refer to our repair and calibration section at www.aemc.com/calibration.

Serial #: _____

Catalog #: 2139.62

Model #: 606

Please fill in the appropriate date as indicated:









Date Received: _____



Date Calibration Due: _____



Chauvin Arnoux[®], Inc.
d.b.a AEMC[®] Instruments
www.aemc.com

TABLE OF CONTENTS

1. INTRODUCTION	7
1.1 INTERNATIONAL ELECTRICAL SYMBOLS.....	7
1.2 DEFINITION OF MEASUREMENT CATEGORIES (CAT)	7
1.3 PRECAUTIONS FOR USE.....	8
1.4 RECEIVING YOUR SHIPMENT	9
1.5 ORDERING INFORMATION.....	9
1.5.1 Accessories.....	9
1.5.2 Replacement Parts	9
2. PRODUCT FEATURES	10
2.1 FRONT & BACK OF INSTRUMENT	11
2.2 ROTARY SWITCH	12
2.3 FUNCTION BUTTONS.....	13
2.4 UNIT DISPLAY.....	14
2.4.1 Display Symbols	14
2.4.2 Measurement Capacity Exceeded (OL)	15
2.5 TERMINALS.....	16
3. FUNCTION BUTTONS	17
3.1  HOLD BUTTON	17
3.2  BUTTON (SECOND FUNCTION)	18
3.3  BACKLIGHT DISPLAY BUTTON	18
3.4  MAX/MIN/PEAK BUTTON.....	19
3.4.1 Normal Mode	19
3.4.2 The MAX/MIN/PEAK Mode + Activation of the HOLD Mode.....	20
3.4.3 Access to the True InRush® Mode ( set to ).....	20
3.5  Hz BUTTON	21
3.5.1 Normal Mode	21
3.5.2 The Hz Function + Activation of the HOLD Mode	22
3.6  REL BUTTON	22
4. OPERATION	23
4.1 INSTALLING BATTERIES.....	23
4.2 TURNING CLAMP-ON METER ON.....	23
4.3 TURNING CLAMP-ON METER OFF	23

4.4 CONFIGURATION.....	24
4.4.1 Configuring the Maximum Resistance for Continuity	24
4.4.2 Auto Power OFF	24
4.4.3 Configuring Current Threshold for True InRush® Measurement..	25
4.4.4 Default Configuration.....	25
4.5 VOLTAGE MEASUREMENT (V)	26
4.6 CONTINUITY TEST 	26
4.6.1 Automatic Lead Resistance Compensation.....	27
4.7 RESISTANCE MEASUREMENT Ω	27
4.8 DIODE TEST 	28
4.9 CURRENT MEASUREMENT (A)	29
4.9.1 AC Measurement	29
4.9.2 DC or AC+DC Measurement	30
4.10 STARTING CURRENT OR OVERCURRENT (TRUE INRUSH®) MEASUREMENT	31
4.11 POWER MEASUREMENTS W, VA, var AND PF	31
4.11.1 Single-Phase Power Measurement.....	32
4.11.2 Balanced Three-Phase Power Measurement.....	32
4.12 PHASE ROTATION MODE	33
4.13 FREQUENCY MEASUREMENT (Hz).....	34
4.13.1 Frequency Measurement (V).....	34
4.13.2 Frequency Measurement (A)	35
4.13.3 Frequency Measurement (W)	35
4.14 MEASUREMENT OF LEVEL OF HARMONICS (THD) AND FREQUENCY OF FUNDAMENTAL (NETWORK)	36
4.14.1. Measurement of THD and Frequency of Fundamental (V)	36
4.14.2. Measurement of THD and Frequency of Fundamental (A).....	37

5. SPECIFICATIONS38

5.1 REFERENCE CONDITIONS	38
5.2 SPECIFICATIONS UNDER REFERENCE CONDITIONS.....	38
5.2.1 DC Voltage Measurement.....	38
5.2.2 AC Voltage Measurement	39
5.2.3 AC+DC Voltage Measurement	39
5.2.4 DC Current Measurement	40
5.2.5 AC Current Measurement.....	40
5.2.6 AC+DC Intensity Measurement.....	41

5.2.7 True InRush® Measurement	41
5.2.8 Continuity Measurement	42
5.2.9 Resistance Measurement.....	42
5.2.10 Diode Test.....	42
5.2.11 Active DC Power Measurements	43
5.2.12 Active AC Power Measurements	43
5.2.13 Active AC+DC Power Measurements	44
5.2.14 Measurement of Apparent AC Power	45
5.2.15 Measurement of Apparent AC+DC Power.....	45
5.2.16 Measurement of Reactive AC Power.....	46
5.2.17 Measurement of Reactive AC+DC Power.....	47
5.2.18 Calculation of the Power Factor.....	47
5.2.19 Frequency Measurement	48
5.2.19.1 Voltage.....	48
5.2.19.2 Current.....	48
5.2.20 Specifications in THDr.....	49
5.2.21 Specifications in THDf.....	49
5.2.22 Indication of Order of the Phases.....	49
5.3 ENVIRONMENTAL CONDITIONS.....	49
5.4 MECHANICAL SPECIFICATIONS.....	50
5.5 POWER SUPPLY.....	50
5.6 COMPLIANCE WITH INTERNATIONAL STANDARDS.....	50
5.7 ENVIRONMENTAL VARIATIONS	50

6. MAINTENANCE52











6.1 WARNING.....	52
6.2 CLEANING.....	52
6.3 REPLACEMENT OF THE BATTERIES.....	52
6.4 REPAIR AND CALIBRATION.....	53
6.5 TECHNICAL ASSISTANCE.....	53
6.6 LIMITED WARRANTY	54
6.6.1 Warranty Repairs	54

1. INTRODUCTION

Thank you for purchasing an AEMC® Instruments **Model 606 Clamp-On Meter**.

For best results from your instrument and for your safety, read the enclosed operating instructions carefully and comply with the precautions for use. Only qualified and trained operators should use this product.

1.1 INTERNATIONAL ELECTRICAL SYMBOLS

	Signifies that the instrument is protected by double or reinforced insulation.
	CAUTION - Risk of Danger! Indicates a WARNING . Whenever this symbol is present, the operator must refer to the user manual before operation.
	Indicates a risk of electric shock. The voltage at the parts marked with this symbol may be dangerous.
	Application or withdrawal authorized on conductors carrying dangerous voltages. Type A current sensor as per IEC 61010-2-032.
	Battery
	Indicates Important information to acknowledge
	This product complies with the Low Voltage & Electromagnetic Compatibility European directives (73/23/CEE & 89/336/CEE).
	In the European Union, this product is subject to a separate collection system for recycling electrical and electronic components in accordance with directive WEEE 2012/19/EU.
	AC - Alternating Current
	AC and DC - Alternating and Direct Current or Voltage
	Ground/Earth

1.2 DEFINITION OF MEASUREMENT CATEGORIES (CAT)

CAT IV: Corresponds to measurements performed at primary electrical supply (< 1000 V).

Example: primary overcurrent protection devices, ripple control units, and meters.

CAT III: Corresponds to measurements performed in the building installation at the distribution level.

Example: hardwired equipment in fixed installation and circuit breakers.

CAT II: Corresponds to measurements performed on circuits directly connected to the electrical distribution system.

Example: measurements on household appliances and portable tools.

1.3 PRECAUTIONS FOR USE

This device complies with safety standards IEC/EN 61010-1 or BS EN 61010-1 and IEC/EN 61010-2-032 or BS EN 61010-2-032 for voltages of 1000 V in CAT IV and 1500 V in CAT III. These safety instructions are intended to ensure the safety of persons and proper operation of the device.

- The operator and/or the responsible authority must carefully read and clearly understand the various precautions to be taken in use.
- If this instrument is used other than as specified, the protection it provides may be compromised, thereby endangering you.
- Do not use the instrument in an explosive atmosphere or in the presence of flammable gases or fumes.
- Do not use the instrument on networks of which the voltage or category exceeds those mentioned.
- Do not exceed the rated maximum voltages and currents between terminals or with respect to earth.
- Do not use the instrument if it appears to be damaged, incomplete, or not properly closed.
- Before each use, check the condition of the insulation on the leads, housing, and accessories. Any element of which the insulation is deteriorated (even partially) must be set aside for repair or scrapped.
- Do not use leads and accessories rated lower for voltages and measurement categories (CAT) than those of the instrument. To avoid safety hazards and ensure that the instrument operates at full capacity, use only leads and accessories rated for voltages and measurement categories (CAT) at least equal to those of the instrument.
- Observe the environmental conditions of use.
- Do not modify the instrument and only use factory replacement parts. Repairs and adjustments must be done by approved qualified personnel.
- Replace the batteries as soon as the  symbol appears on the display of the unit. Disconnect all leads before opening the battery compartment cover.
- Use personal protective equipment when conditions require.
- Keep your hands away from the unused terminals of the instrument.
- When handling the test probes, alligator clips, and clamp ammeters, keep your fingers behind the physical guard.
- As a safety measure, and to avoid repeated overloads on the inputs of the device, configuration operations should only be performed when the device is disconnected from all dangerous voltages.

1.4 RECEIVING YOUR SHIPMENT

Upon receiving your shipment, make sure that the contents are consistent with the packing list. Notify your distributor of any missing items. If the equipment appears to be damaged, file a claim immediately with the carrier and notify your distributor at once, giving a detailed description of any damage. Save the damaged packing container to substantiate your claim.

1.5 ORDERING INFORMATION

Clamp-On Meter Model 606 **Cat. #2139.62**
Includes set of two color-coded silicone insulated test leads, test probes and alligator clips, soft carrying case, four 1.5 V AA batteries, and user manual.

1.5.1 Accessories

Multi-purpose Canvas Pouch..... **Cat. #2119.48**
Set of two 5 ft (1.5 m) Needle Tip Color-coded (Red/Black) Leads w/ 4 mm Right-angle Plug (600 V CAT IV w/shield on Needle Tip, 1000 V CAT II w/o shield)..... **Cat. #2154.74**

1.5.2 Replacement Parts

Soft Carrying Case..... **Cat. #2139.72**
Set of two Color-coded Silicone Test Leads (Red/Black) 5 ft..... **Cat. #2152.15**
Probe - Black Test Probe (Rated 1000 V CAT IV, 15 A, UL V2) **Cat. #5000.97**
Probe - Red Test Probe (Rated 1000 V CAT IV, 15 A, UL V2) **Cat. #5000.98**
Set of two Color-coded Silicone Test Leads (Red/Black) 5 ft with 4 mm straight/right angle banana plugs (Rated 1000 V, CAT IV, UL V2) **Cat. #5000.94**
Safety Alligator Clip (Black) **Cat. #5000.99**
Safety Alligator Clip (Red)..... **Cat. #5100.00**

Order Accessories and Replacement Parts Directly Online

Check our Storefront at www.aemc.com/store for availability

2. PRODUCT FEATURES

The Clamp-On Meter Model 606 is a 10,000-count professional electrical measuring instrument that combines the following functions:

- Current measurement
- Measurement of Inrush current / overcurrent (True InRush®)
- Voltage measurement
- Frequency measurement
- Measures harmonic distortion (THD)
- Continuity test with buzzer
- Resistance measurement
- Diode test
- Power measurements (W, VA, var and PF)
- Phase order indication

2.1 FRONT & BACK OF INSTRUMENT



Figure 1



Figure 2

Item	Designation	See §
1	Jaws with centering marks (see connection principles)	4.5 to 4.14
2	Physical Guard	-
3	Rotary Switch	2.2
4	Function Buttons	2.3
5	Backlit Display	2.4
6	Input Terminals	2.5
7	Trigger	-
8	Battery Compartment & Compartment Screw (see § 4.1 for instructions on installing the batteries)	2.1

2.2 ROTARY SWITCH

The rotary switch has six positions.

To access the **V** \approx , **A** \approx , **VA** \approx , **var** \approx , **W** \approx , **PF** \approx , **Ω** \approx , **▶|** \approx , and **1-2-3** \approx functions, set the rotary switch to the desired function. Each setting is confirmed by an audible signal.

The functions are described in the table below.

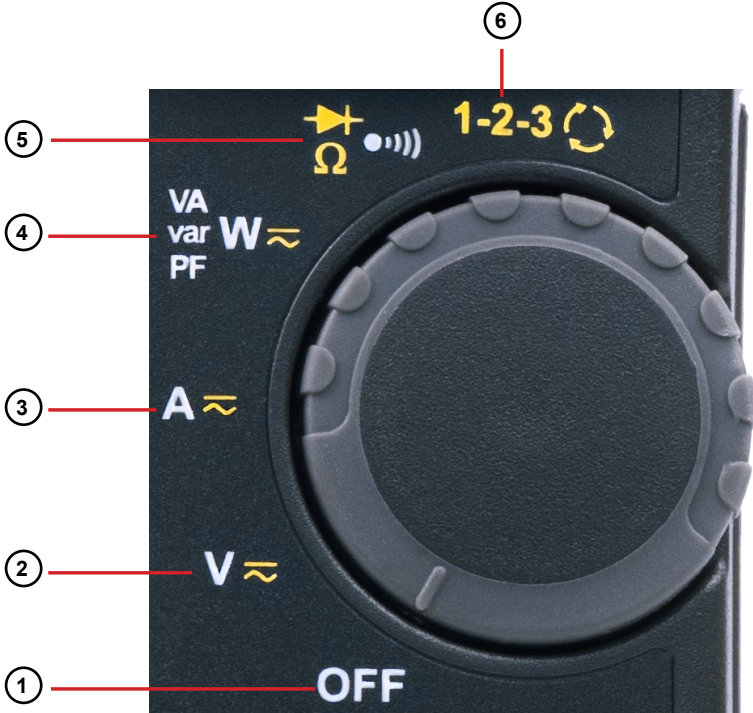

Figure 3

Item	Function	See §
1	OFF mode – Turns the clamp-on meter off	4.3
2	AC, DC, AC+DC voltage measurement (V)	4.5
3	AC, DC, AC+DC current measurement (A)	4.9
4	Power measurements (W, var, VA) and calculation of the power factor (PF) AC, DC, AC+DC	4.11
5	Continuity test ●)	4.6
	Resistance measurement Ω	4.7
	Diode test ▶ 	4.8
6	Phase rotation order indicator 1-2-3 \approx	4.12

2.3 FUNCTION BUTTONS



Figure 4

Item	Function	See §
1	Holds the last value on the display	3.1
	Zero correction ADC / A _{AC+DC} / W _{DC} / W _{AC+DC}	
	Lead resistance compensation in the continuity and ohmmeter function	4.6.1
	DC or AC+DC Measurement	4.9.2
2	Correct the DC Zero	
	Selects the type of measurement and configuration functions (AC, DC, AC+DC)	3.2
3	Selection of single-phase or three-phase measurement	
	Enables/Disables display backlighting	3.3
4	Enables/Disables the MAX/MIN/PEAK mode	
	Enables/Disables the True InRush® mode in current measurement (A)	3.4
5	Performs frequency measurements (Hz) and selects measurement of harmonic distortion (THD)	3.5
	Display of the powers W, VA, var and PF	
6	Activation of ΔREL mode	3.6
	Displays differential and relative values	

2.4 UNIT DISPLAY

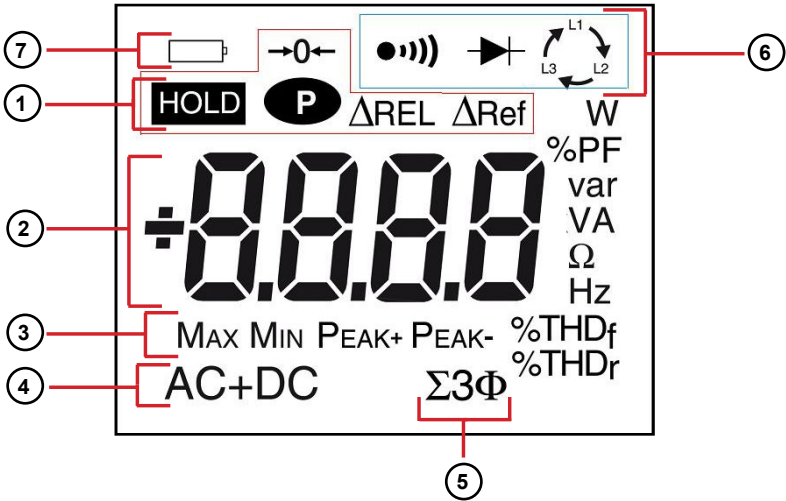







Figure 5

Item	Function	See §
1	Mode selection display	3
2	Active measurement value and unit display	4.5 to 4.12
3	Display of the MAX/MIN/PEAK modes	3.4
4	Type of measurement (AC, DC or AC+DC)	3.2
5	Total three-phase power measurements	4.11.2
6	Display of the selected modes (rotary switch)	2.2
7	Low battery indication	6.3

2.4.1 Display Symbols

Symbol	Description
AC	Alternating current or voltage
DC	Direct current or voltage
AC+DC	Alternating and Direct current or voltage
ΔREL	Relative value, with respect to a reference
ΔRef	Reference value
HOLD	Storage of the values and display HOLD
Max	Maximum DC or RMS value
Min	Minimum DC or RMS value

Symbol	Description
Peak+	Maximum peak value
Peak-	Minimum peak value
$\Sigma 3\Phi$	Balanced total three-phase power measurement
V	Volt
Hz	Hertz
W	Watt
A	Ampere
%	Percentage
Ω	Ohm
m	Milli- prefix
k	Kilo- prefix
var	Reactive power
VA	Apparent power
PF	Power factor
THDf	Total harmonic distortion with respect to the fundamental
THDr	Total harmonic distortion with respect to the true RMS value of the signal
	Phase order indicator
$\rightarrow 0 \leftarrow$	Lead resistance compensation
	Continuity test
	Diode test
	Permanent display Auto Power Off disabled
	Low battery indicator

The display of **rdy**, for **ready**, indicates that the device is ready (**Phase Order Indication** function).

2.4.2 Measurement Capacity Exceeded (OL)

The **OL** (Over Load) symbol is displayed when the display capacity is exceeded.

2.5 TERMINALS

The terminals are used as follows:



Figure 6

Item	Function
1	COM (black) Input Terminal Jack
2	+ Positive (red) Input Terminal Jack

3. FUNCTION BUTTONS

The buttons respond differently to short, long, and sustained presses.

The **MAX/MIN/PEAK**, **Hz**, and **ΔREL** buttons provide additional functions and provide the detection and acquisition of parameters complementary to the basic measurements.

- Each of these buttons can be used independently of the others or in conjunction with each other. This makes navigation simple and intuitive when reviewing measurement results.
- It is possible, for example, to look up in turn the MAX, MIN, etc. values of the RMS voltage alone, or else look up in turn all of the MAX (or MIN, or PEAK) values of all power results (W, VA, var, etc.).







In this section, the  icon represents the possible positions located on the rotary switch for each button's functionality.

3.1 **HOLD** BUTTON

The function of this button is to:

- Store and look up the last values acquired specific to each function (**V**, **A**, **Ω**, **W**) according to the specific modes previously activated (**MAX/MIN/PEAK**, **Hz**, **ΔREL**, **THD**). The present display is then maintained while the detection and acquisition of new values continues.
- Perform automatic lead resistance compensation (see § 4.6.1).
- Perform automatic zero correction in $A_{DC}/AC+DC$ and $W_{DC}/AC+DC$ (see § 4.9.2).

 **NOTE:** **HOLD** is invalid for the **Phase Rotation Order Indicator** function.

Successive presses on HOLD		Function
short	   	First Press: Stores the results of the present measurements. Second Press: Holds the display of the last value displayed. Third Press: Returns to normal display mode (each new measurement value is displayed).
long (> 2 sec)	A_{DC} A_{AC+DC} W_{DC} W_{AC+DC}	Performs automatic zero correction (see § 4.9.2) NOTE: This mode operates if the MAX/MIN/PEAK or HOLD modes (short press) are first deactivated
sustained		Performs automatic lead resistance compensation (See § 4.6.1)









See § 3.4.2 and § 3.5.2 for the **HOLD** button functionality in combination with the **MAX/MIN/PEAK** and **Hz** buttons.

3.2 BUTTON (SECOND FUNCTION)



This button is used to select the type of measurement (AC, DC, AC+DC) and the second functions marked in yellow next to the relevant positions of the rotary switch. It can also be used to modify the default values in the configuration mode (see § 4.4).

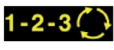

NOTE:  is invalid in the **MAX/MIN/PEAK**, **HOLD** and **ΔREL** modes.

Successive presses on 		Function
short		- Selects AC , DC or AC+DC . Depending on your choice, the screen displays AC, DC or AC+DC
		- Cycles through the Ω and diode test  modes and returns to the continuity test 
		- Resets the measurement process for the phase rotation order indicator function
long (> 2 sec)		- Displays the total three-phase power of a balanced system ($\Sigma 3\Phi$ is displayed) - Press again to return to the display of the single-phase power ($\Sigma 3\Phi$ is off)

3.3 BACKLIGHT DISPLAY BUTTON

Successive presses on 		Function
		Enables/Disables display backlighting



NOTE: The backlighting is automatically disabled at the end of two minutes.





3.4 MAX/MIN/PEAK BUTTON

3.4.1 Normal Mode

This button activates the detection of the **MAX**, **MIN**, **PEAK+** and **PEAK-** values of the measurements generated. MAX and MIN are the extreme mean values in DC and the extreme RMS values in AC. Peak+ is the maximum instantaneous peak and Peak- the minimum instantaneous peak.









NOTE: In this mode, the **Auto Power Off** function of the device is automatically disabled. The **P** symbol is displayed on the screen.

Successive presses on 		Functions
short		<ul style="list-style-type: none"> - First press: Activates detection of MAX/MIN/PEAK values - Second press: Displays the MAX or MIN, PEAK+ or PEAK- value successively - Third press: Returns to the display of the present measurement without exiting from the mode (the values already detected are not erased) <p>NOTE: The MAX, MIN, PEAK+ or PEAK- symbols are all displayed, but only the symbol of the measurement selected blinks.</p> <p><i>Example: If MIN has been selected, MIN blinks and MAX, PEAK+ and PEAK- are lit steadily.</i></p>
		<ul style="list-style-type: none"> - Activates the detection of MAX/MIN values - Displays the MAX or MIN value successively - Returns to the display of the present measurement without exiting from the mode (the values already detected are not erased)
long (> 2 sec)		<ul style="list-style-type: none"> - Exits the MAX/MIN/PEAK mode. The values previously recorded are then erased <p>NOTE: If the HOLD function is activated, it is not possible to exit from the MAX/MIN mode. The HOLD function must first be disabled.</p>



NOTE: The **ΔREL** function can be used with the functions of the **MAX/MIN/PEAK** mode.



3.4.2 The MAX/MIN/PEAK Mode + Activation of the HOLD Mode



Successive presses on 		Function
short	   	- Displays successively the MAX/MIN/PEAK values detected before the HOLD button was pressed



 **NOTE:** **HOLD** function does not interrupt the acquisition of new MAX/MIN/PEAK values.

3.4.3 Access to the True InRush® Mode (set to)

This button allows measurement of the True InRush® current (starting current, or overcurrent in steady-state operation) for AC or DC current only.

 **NOTE:**  is not operational for AC+DC current.

Successive presses on 		Function
long (> 2 sec)		<ul style="list-style-type: none"> - First press: Enters the True InRush® mode - Inrh is displayed for 3 sec (the backlighting blinks) - The triggering threshold is displayed for 5 sec (the backlighting is steady) - ---- is displayed and the A symbol flashes. - After detection and acquisition, the inrush current measurement is displayed, after the calculations stage ---- (backlighting turns OFF) <p>NOTE: The A symbol flashes to indicate surveillance of the signal.</p> <ul style="list-style-type: none"> - Second press: Exits the True InRush® mode (returns to simple current measurement)

Successive presses on 		Function
short (< 2 sec) NOTE: A short press is functional only if a True InRush® value has been detected.		<ul style="list-style-type: none"> - Displays the PEAK+ value of the current - Displays the PEAK- value of the current - Displays the RMS True InRush® current NOTE: The A symbol is displayed steadily this sequence.





3.5 **BUTTON**

This button is used to display the frequency measurements of a signal, of the power, and of the level of harmonics.







NOTE: This button is not functional in the DC mode.

3.5.1 Normal Mode

Successive presses on 		Function
short		Displays: <ul style="list-style-type: none"> - The frequency of the signal measured - The present voltage (V) or current (A) measurement
		Displays: <ul style="list-style-type: none"> - The apparent power (VA) - The reactive power (var) - The power factor (PF) - The frequency of the signal - The active power (W)
long (> 2 sec)		- Enters or exits from the level of harmonics (THD) calculation and display mode
then short		- Selects THDf , THDr or the frequency of the fundamental

3.5.2 The Hz Function + Activation of the HOLD Mode





Successive presses on 		Function
short		<ul style="list-style-type: none"> - Holds the last frequency reading - Successively displays the last held frequency, then the voltage or the current - Displays in turn the stored values of THDf then of THDr, then of the frequency of the fundamental <p>NOTE: Pressing the  button a second time returns to real-time measurement updates.</p>

3.6 BUTTON

This button is used to display and store the reference value in the unit of magnitude measured, or to display the differential and relative values in %.



NOTE: The **Relative mode ΔREL** is not operational in phase rotation mode.

Successive presses on 		Function
short		<ul style="list-style-type: none"> - Enters the ΔREL mode, to store, then displays the reference value. The ΔRef symbol is displayed. - Displays the differential value: (current value – reference (Δ)) The ΔREL symbol is displayed. - Displays the relative value in %: $\frac{\text{current value} - \text{reference} (\Delta)}{\text{reference} (\Delta)}$ The ΔRef and % symbols are displayed. - Displays the reference. The ΔRef symbol is displayed. - Displays the current value. The ΔRef symbol blinks.
long (> 2 sec)		<ul style="list-style-type: none"> - Exits from ΔREL mode



NOTE: The **Relative mode ΔREL** function can also be used with the functions of the **MAX/MIN/PEAK** mode.

4. OPERATION

4.1 INSTALLING BATTERIES

Insert the batteries supplied with the device as follows:

1. Using a screwdriver, unscrew the battery compartment cover (1) from the back of the housing.
2. Insert the (4) 1.5 V AA batteries supplied into battery compartment (2), observing polarities.
3. Close the battery compartment cover and screw it onto the housing.

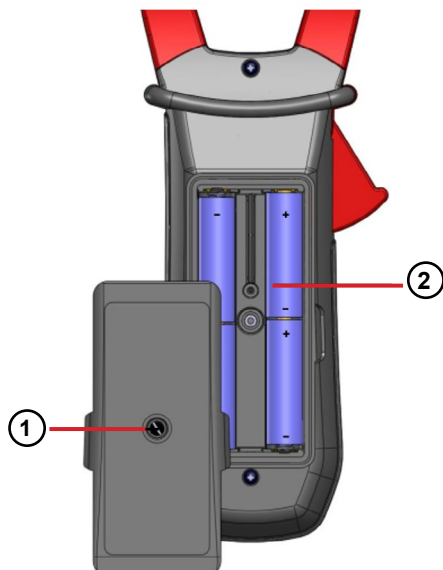

Figure 7

4.2 TURNING CLAMP-ON METER ON

- With the rotary switch set to the **OFF** position, turn the switch to the desired function. The display lights all symbols for a few seconds (see § 2.2), then the screen of the chosen function is displayed.
- The clamp-on meter is now ready to make measurements.

4.3 TURNING CLAMP-ON METER OFF

The clamp-on meter can be turned off in two ways:







- **Manually:** Turn the rotary switch to the **OFF** position.
- **Automatically:** After ten minutes with no activity, the instrument will turn **OFF**. Thirty (30) seconds before the device automatically switches off, an audible signal sounds intermittently. To re-activate the device, press any button or turn the rotary switch.

4.4 CONFIGURATION

As a safety measure and to avoid repeated overloads on the inputs of the device, configuration operations should only be performed when the device is disconnected from all dangerous voltages.

4.4.1 Configuring the Maximum Resistance for Continuity

To configure the maximum resistance allowed for a continuity:





1. With the rotary switch in the **OFF** position, hold the  button down while turning the switch to , until the **full screen** display ends and a beep is emitted, to enter the configuration mode. The display will indicate the value. The buzzer is activated and the  symbol is displayed. The value stored by default is 40 Ω . The possible values range between (1 and 999) Ω .
2. To change the threshold, press the  button. The right-hand digit flashes; each press on the  button will adjust the threshold in increments of one digit. To shift to the next digit level, apply a long press (> 2 sec) to the  button.

When the desired value is displayed, turn the rotary switch to another setting to exit the programming mode. The detection threshold chosen is stored and a double beep is emitted.

4.4.2 Auto Power OFF





The **Auto Power OFF** feature is enabled by default.

To disable **Auto Power OFF**:

1. With the rotary switch in the **OFF** position, hold the  button down while turning the switch to , until the **full screen** display ends and a beep is emitted. The  symbol is displayed.
2. When the  button is released, the device is in the **voltmeter function** in the **normal mode**.
3. To return to **Auto Power OFF**, turn the clamp-on meter **OFF** and then back **ON**.

4.4.3 Configuring Current Threshold for True InRush® Measurement

To configure the triggering current threshold of the True InRush® measurement:

1. In the **OFF** position, hold the  button down while turning the rotary switch to  until the **full screen** display ends and a beep is emitted. The display will indicate the percentage overshoot to apply to the measured current to determine the measurement triggering threshold. The value stored by default is 10 %, representing 110 % of the established current measured. The possible values are (5, 10, 20, 50, 70, 100, 150, and 200) %.
2. To change the threshold, press the  button. The value will flash; each press on the  button displays the next value. To record the chosen threshold, apply a long press (> 2 sec) on the  button. A confirmation beep is emitted.



When the desired value is displayed, turn the rotary switch to another setting. The chosen threshold is stored and a double beep is emitted.



NOTE: The starting (inrush) current measurement triggering threshold is fixed at 1 % of the least sensitive range.
This value is 1 % of 99.99 A or 1 A.



4.4.4 Default Configuration

To reset the clamp-on meter to its default parameters (factory configuration):

1. With the rotary switch in the the **OFF** position, hold the  button down while turning the switch to , until the **full screen** display ends and a beep is emitted. The meter is now in configuration mode. The **rSt** symbol is displayed.
2. After 2 sec, the clamp-on meter emits a double beep, then all of the digital symbols on the screen are displayed until the  button is released. The default parameters are then restored:
 - Continuity detection threshold = 40 Ω
 - True InRush® triggering threshold = 10 %

4.5 VOLTAGE MEASUREMENT (V)

To measure voltage:

1. Set the rotary switch to .
2. Connect the black lead to the **COM** terminal and the red lead to the **+** terminal.
3. Connect the test probes or the alligator clips to the circuit to be measured. The device selects AC or DC automatically according to which measured value is larger. The AC or DC symbol lights in blinking mode. The AC or DC symbol lights in blinking mode.
4. To select AC or DC or AC+DC manually, press the  button to toggle between the options. The symbol of the chosen option will then display in fixed mode.

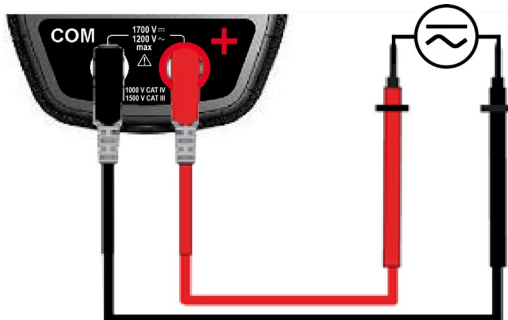



The measured value is displayed on the screen.

4.6 CONTINUITY TEST



WARNING: Before performing the test, make sure that the circuit is **OFF** and all capacitors have been discharged.

1. Set the rotary switch to ; the  symbol is displayed.
2. Connect the black lead to the **COM** terminal and the red lead to the **+** terminal.
3. Connect the test probes or the alligator clips to the circuit or component to be measured.

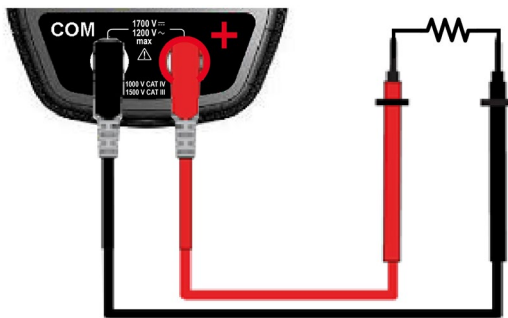

An audible signal is emitted if there is continuity, and the measured value is displayed on the screen.

4.6.1 Automatic Lead Resistance Compensation



WARNING: Before the compensation is executed, the **MAX/MIN/PEAK** and **HOLD** modes must be de-activated.

To perform automatic compensation of the test lead resistance:

1. Short-circuit the leads connected to the meter.
2. **Hold** the **HOLD** button down until the display unit indicates the lowest value. The device measures the resistance of the leads.
3. **Release** the **HOLD** button. The correction and the $\rightarrow 0 \leftarrow$ symbol are displayed. The value displayed is stored.





NOTE: The correction value is stored only if it is $\leq 2 \Omega$. Above 2Ω , the value displayed blinks and is not stored.

4.7 RESISTANCE MEASUREMENT Ω



WARNING: Before making a resistance measurement, make sure that the circuit is **OFF** and all capacitors have been discharged.

1. Set the rotary switch to  and press the  button. The Ω symbol is displayed.
2. Connect the black lead to the **COM** terminal and the red lead the **+** terminal.
3. Connect the test probes or the alligator clips to the circuit or component to be measured.

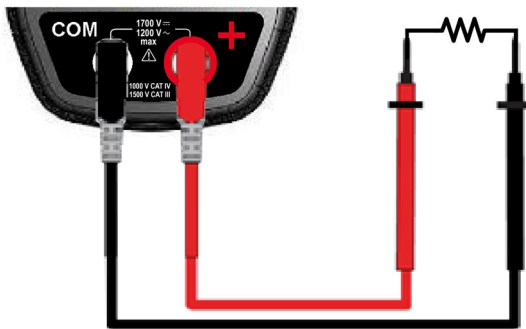

The measured value is displayed on the screen.





NOTE: To measure low resistance values, first perform lead resistance compensation (see § 4.6.1).

4.8 DIODE TEST



WARNING: Before performing the diode test, make sure that the circuit is **OFF** and all capacitors have been discharged.

1. Set the rotary switch to  and press the  button **twice**. The  symbol is displayed.
2. Connect the black lead to the **COM** terminal and the red lead to the **+** terminal.
3. Connect the test probes or the alligator clips to the circuit or component to be tested.

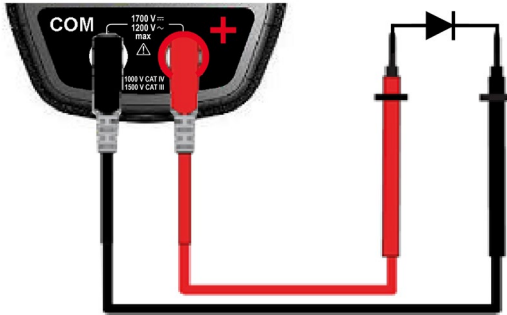

The measured value is displayed on the screen.

4. Reverse the leads on the diode and repeat the test.

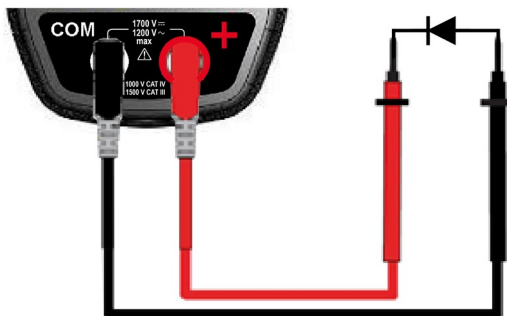

The measured value is displayed on the screen

4.9 CURRENT MEASUREMENT (A)

The jaws are opened by pressing the trigger on the body of the meter. The arrow on the jaws of the clamp-on meter (see the diagram below) should point in the presumed direction of current flow, from the generator to the load. Make sure that the jaws have closed correctly after clamping around the conductor.





NOTE: The measurement results are optimal when the conductor is centered in the jaws (aligned with the centering marks).

The device selects **AC** or **DC** automatically according to which measured value is larger. The AC or DC symbol blinks.

4.9.1 AC Measurement

For an AC current measurement:

1. Set the rotary switch to **A**  and select **AC** by pressing the  button. The AC symbol is displayed.
2. Clamp the jaws around the conductor to be measured. The device selects **AC** or **DC** automatically.

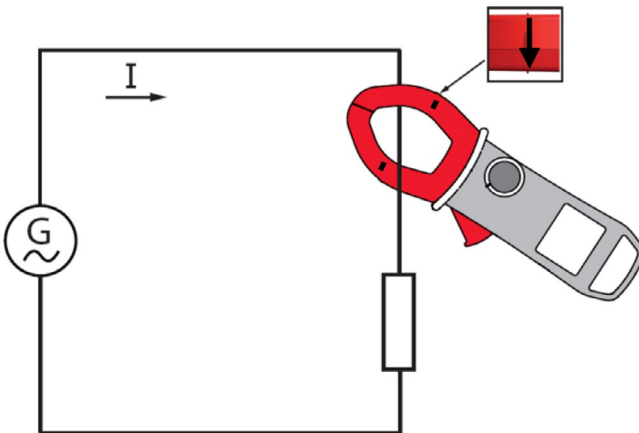

The measured value is displayed on the screen

4.9.2 DC or AC+DC Measurement

Set the rotary switch to **A** and select **DC**. If the display does not indicate **0**; the DC zero must first be corrected.

Step 1: Correct the DC Zero:



NOTE: IMPORTANT - The clamp **must not** be closed on the conductor during the DC zero correction. Hold the clamp in the same position during the whole procedure so that the correction value will be exact.

1. Press the **HOLD** button until the device emits a double beep and displays a value near **0**. The correction value is stored until the clamp is powered down.



NOTE: The correction is affected only if the value displayed is $< \pm 20$ A, otherwise the value displayed blinks and is not stored. The clamp must be recalibrated (see § 6.4).

Step 2: Make a Measurement:

1. The rotary switch is set to **A**. Select **DC** or **AC+DC** by pressing the **YELLOW** button until the desired choice is reached.
2. Clamp the jaws around the conductor to be measured.

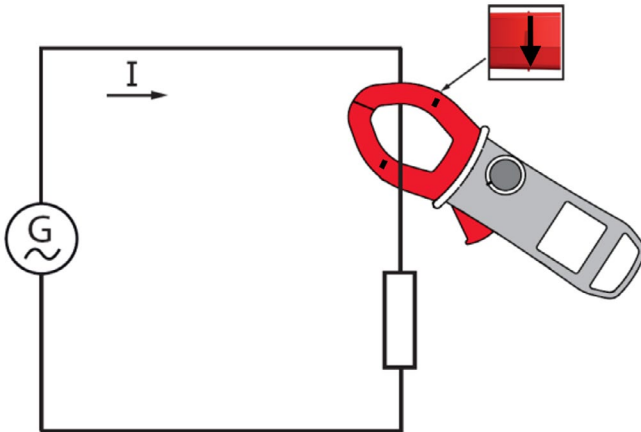

The measured value is displayed on the screen.

4.10 STARTING CURRENT OR OVERCURRENT (True InRush®) MEASUREMENT



NOTE: The measurement can be made only in AC or DC (AC+DC mode disabled).

To measure a starting current or overcurrent:

1. Set the rotary switch to **A** , correct the DC zero (see § 4.9.2), then clamp the jaws around the conductor to be measured.
 2. Perform a long press on the **MAX/MIN PEAK** button. The **InRh** symbol is displayed, along with the triggering threshold. The clamp then awaits detection of the True InRush® current. **----** is displayed and the **A** symbol flashes.
 3. After detection and acquisition for 100 ms, the RMS value of the True InRush® current is displayed. Pressing the **MAX/MIN PEAK** button will display the **PEAK+/PEAK-** values subsequently.
 4. A long press on the **MAX/MIN PEAK** button or a change of function on the rotary switch will result in an exit of the True InRush® mode.
-



NOTE: The triggering threshold in A is 20 A if the initial current is zero (starting of installation). For an established current (overload in an installation) see § 4.4.3.

4.11 POWER MEASUREMENTS W, VA, var AND PF

The measurement is possible in single-phase or in balanced three-phase.



NOTE 1: In DC or AC+DC power measurement, first correct the DC zero in current (see § 4.9.2).

NOTE 2: For the power factor (PF) and the powers VA and var, the measurement is possible only in AC or AC+DC.

4.11.1 Single-Phase Power Measurement

1. Set the rotary switch to **VA**, **var** or **PF** and select **VA**, **var** or **PF** by pressing the **Hz** button until the desired choice is reached.
 2. The device automatically displays AC+DC. To select **AC**, **DC** or **AC+DC**, press the **[Yellow]** button until the desired choice is reached.
 3. Connect the black lead to the **COM** terminal and the red lead to the **+** terminal.
 4. Connect the test probes or alligator clips of the black lead on the **neutral (N)**, then those of the red lead on the **L phase (L)**.
 5. Clamp only the corresponding conductor, respecting the direction.
- The measured value is displayed on the screen.

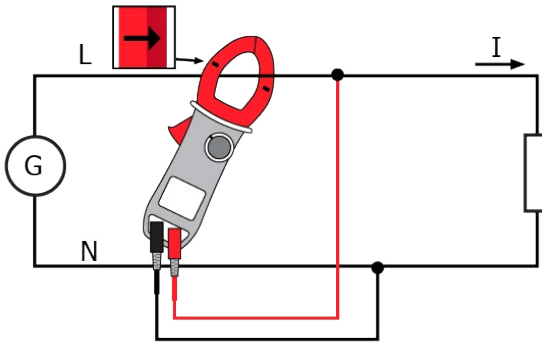

4.11.2 Balanced Three-Phase Power Measurement

1. Set the rotary switch to **VA**, **var** or **PF** and select **VA**, **var** or **PF** by pressing the **Hz** button until the desired choice is reached.
2. Press and hold (> 2 sec) the **[Yellow]** button until the $\Sigma 3\Phi$ symbol is displayed.
3. The device automatically displays AC+DC. To select **AC**, **DC** or **AC+DC**, short press the **[Yellow]** button until the desired choice is reached.
4. Connect the black lead to the **COM** terminal and the red lead to the **+** terminal.
5. Connect the leads and the clamp to the circuit as follows:

If the red lead is connected...	...and the black lead is connected	...then the clamp is around the conductor
to the L1 phase	to the L2 phase	to the L3 phase
to the L2 phase	to the L3 phase	to the L1 phase
to the L3 phase	to the L1 phase	to the L2 phase

The measured value is displayed on the screen.



NOTE: The arrow on the jaws of the clamp (see the diagram below) must point in the presumed direction of flow of the current from the source (producer) to the load (consumer).

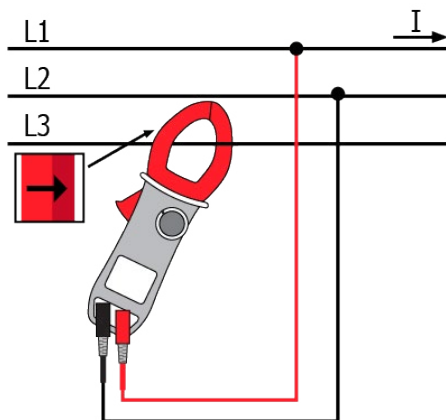



NOTE: You can also measure the three-phase power on a balanced 4-wire network by proceeding in the same way, or by proceeding as for the measurement on a single-phase network, then multiplying the value found by three).

4.12 PHASE ROTATION MODE

This mode is used to determine the order of the phases of a three-phase network by the **2-wire** method.

To determine the order of the phases:

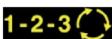
Step 1: Determining the Reference period:

1. Set the rotary switch to . The **rdy** symbol is displayed. The device is ready for the first phase order determination measurement.
2. Connect the black lead with alligator clip to the **COM** terminal and the red lead with test probe to the **+** terminal.
3. Connect the black lead to the presumed **L1 phase** and connect the red test probe to the presumed **L2 phase**.
4. Press the  button. The **ref** symbol blinks on the screen. The instrument is ready to determine the reference period. When the reference period has been determined, an audible signal sounds and the

ref and  symbols are displayed.

NOTE: If the reference period has not been determined, the device emits a beep and displays the **Err Hz** or **Err V** message.



The  symbol flashes, then the **rdy** message is displayed on the screen. Repeat the procedure starting from Step 1, # 4.

Step 2: Determining the Measurement period:

1. Within the next 10 seconds, apply the test probe to the presumed **L3 phase**. The **MEAS** indication then blinks on the display unit as soon as the **L2 phase** is disconnected, the device is now in the calculation phase.



NOTE: If the measurement period has not been determined, the device emits a beep and displays the **Err Hz** or **Err V** message, then **rdy**. Repeat the procedure starting from Step 1, # 4.

Result: When the order of the phases has been determined, the device emits a beep and the indication of order of the phases is displayed on the screen, as follows:

- 0.1.2.3 when the direction of rotation is direct. The **0** symbol blinks and turns clockwise,
- 0.3.2.1 when the direction of rotation is reversed: The **0** symbol blinks and turns counterclockwise.





NOTE: If the order of the phases has not been determined, the device emits a beep and displays the **Err** message. Repeat the procedure starting from Step 1, # 4.

4.13 FREQUENCY MEASUREMENT (Hz)

The frequency measurement is available in **V**, **W** and **A** for AC and **AC+DC** quantities. The measurement is based on a count of the passages of the signal through zero (positive-going edges).

4.13.1 Frequency Measurement (V)

To measure the frequency in voltage:

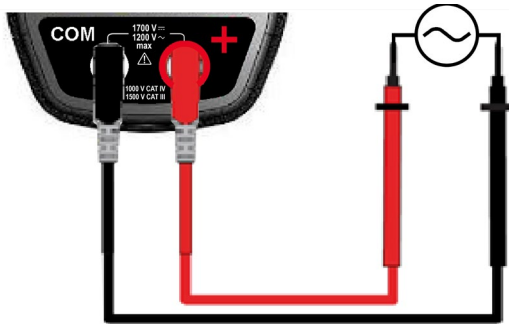

1. Set the rotary switch to , the meter will default to DC voltage.
2. Select **AC** or **AC+DC** by pressing the  button until the desired choice is reached.
3. Press the  button. The **Hz** symbol is displayed.
4. Connect the black lead to the **COM** terminal and the red lead to the **+** terminal.

5. Connect the test probes or the alligator clips to the circuit to be measured.



The measured value is displayed on the screen.

4.13.2 Frequency Measurement (A)

1. Set the rotary switch to **A** , the meter will default to DC current.
2. Select **AC** or **AC+DC** by pressing the  button until the desired choice is reached.
3. Press the **Hz**  button. The **Hz** symbol is displayed.
4. Clamp the jaws around the conductor to be measured.

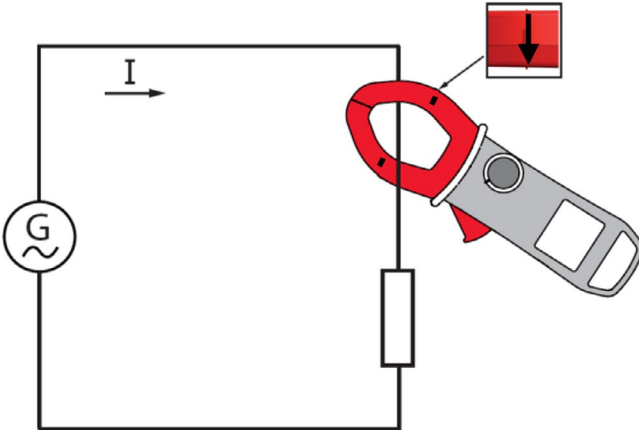

The measured value is displayed on the screen.

4.13.3 Frequency Measurement (W)

In the single-phase AC or AC+DC Power (W) setting, it is possible to display the frequency of the voltage of the signal on the terminals.

In the balanced three-phase AC or AC+DC Power (W) setting, it is possible to display the frequency of the phase-to-phase voltage of the signal on the terminals.

4.14 MEASUREMENT OF LEVEL OF HARMONICS (THD) AND FREQUENCY OF FUNDAMENTAL (NETWORK)

The device measures the total harmonic distortion with respect to the fundamental (THD_f) and the total harmonic distortion with respect to the true RMS value of the signal (THD_r) in voltage and in current. Similarly, it determines the frequency of the fundamental by digital filtering and FFT, for network frequencies of (50, 60, 400, and 800) Hz.

4.14.1. Measurement of THD and Frequency of Fundamental (V)

1. Set the rotary switch to , the meter will default to DC voltage.



NOTE: THD is not available in DC.

2. Press the  button once to reach **AC** or twice to reach **AC+DC**.

3. Once the desired choice is reached, press and hold (> 2 sec) the  button. The **THD_f** symbol is displayed.

To select **THD_r**, again press the  button. The **THD_r** symbol is displayed.

To select the frequency of the fundamental, again press the  button. The **Hz** symbol is displayed.

4. Connect the black lead to the **COM** terminal and the red lead to the **+** terminal.
5. Connect the test probes or the alligator clips to the terminals of the circuit to be measured.

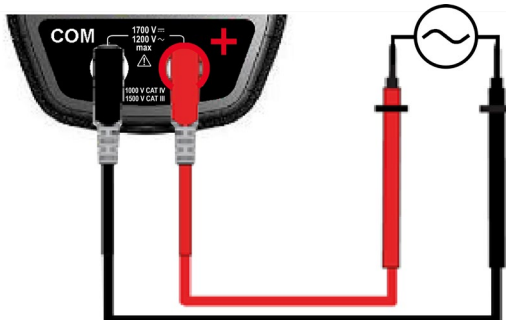



The measured value is displayed on the screen.

4.14.2. Measurement of THD and Frequency of Fundamental (A)

1. Set the rotary switch to **A** , the meter will default to DC voltage.

 **NOTE:** THD is not available in DC.

2. Press the  button once to reach **AC** or twice to reach **AC+DC**.

3. Once the desired choice is reached, press and hold (> 2 sec) the  button. The **THDf** symbol is displayed.

To select **THDr**, again press the  button. The **THDr** symbol is displayed.

To select the frequency of the fundamental, again press the  button. The **Hz** symbol is displayed.

4. Clamp the jaws around the conductor to be measured.

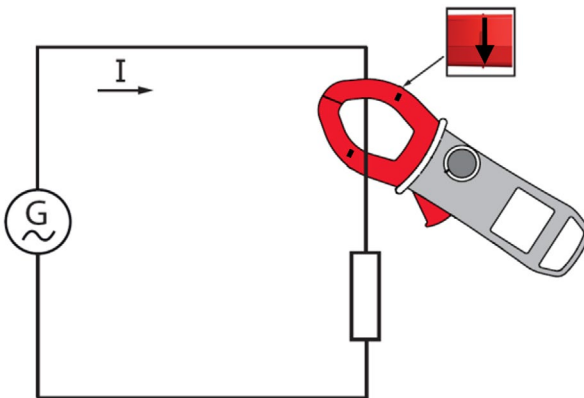

The measurement value is displayed on the screen.

5. SPECIFICATIONS

5.1 REFERENCE CONDITIONS

Quantities of Influence	Reference Conditions
Temperature	(73.4 ± 3.6) °F (23 ± 2) °C
Relative humidity	(45 to 75) %
Supply voltage	(6.0 ± 0.5) V
Frequency range of the applied signal	(45 to 65) Hz
Sine wave	Pure
Peak factor of the applied alternating signal	$\sqrt{2}$
Position of the conductor in the clamp	Centered
Adjacent conductors	none
Alternating magnetic field	none
Electric field	none

5.2 SPECIFICATIONS UNDER REFERENCE CONDITIONS

Accuracy is expressed in \pm (x % of the reading (R) + y counts (ct)).

5.2.1 DC Voltage Measurement

Measurement Range	(0.00 to 99.99) V	(100.0 to 999.9) V	(1000 to 1700) V ⁽¹⁾
Specified Measurement Range	(0 to 1600) V		
Accuracy	(0.00 to 9.99) V \pm (1 % R + 10 cts) (10.00 to 99.99) V \pm (1 % R + 3 cts)	\pm (1 % R + 4 cts)	
Resolution	0.01 V	0.1 V	1 V
Input Impedance	10 M Ω		

- (1) The display indicates **+OL** above + 3400 V and **-OL** below - 3400 V, in **REL** mode. Above 1700 V, a repetitive beep indicates that the voltage being measured is greater than the safety voltage for which the device is guaranteed.

5.2.2 AC Voltage Measurement

Measurement Range	(0.15 to 99.99) V	(100.0 to 999.9) V	(1000 to 1200) V _{RMS} 1700 V peak ⁽¹⁾
Specified Measurement Range⁽²⁾	(0 to 1100) V _{AC} / 1600 V peak		
Accuracy	(0.15 to 9.99) V ± (1 % R + 10 cts) (10.00 to 99.99) V ± (1 % R +3 cts)	± (1 % R + 4 cts)	
Resolution	0.01 V	0.1 V	1 V
Input Impedance	10 MΩ		

- (1) The display indicates **OL** above 1700 V (in **PEAK** mode).
Above 1200 V_{RMS}, a repetitive beep indicates that the voltage being measured is greater than the safety voltage for which the device is guaranteed.
Bandwidth in AC = 3 kHz
- (2) Any value between zero and the min threshold of the measurement range (0.15 V) is forced to **----** on the display.

5.2.3 AC+DC Voltage Measurement

Measurement Range⁽²⁾	(0.15 to 99.99) V	(100.0 to 999.9) V	(1000 to 1200) V _{RMS} 1700 V peak ⁽¹⁾
Specified Measurement Range	(0 to 1100) V _{AC} / 1600 V peak		
Accuracy	(0.15 to 9.99) V ± (1 % R + 10 cts) (10.00 to 99.99) V ± (1 % R +3 cts)	± (1 % R + 4 cts)	
Resolution	0.01 V	0.1 V	1 V
Input Impedance	10 MΩ		

- (1) The display indicates **OL** above 1700 V (in **PEAK** mode).
Above 1200 V (DC or RMS), a repetitive beep indicates that the voltage being measured is greater than the safety voltage for which the device is guaranteed.
Bandwidth in AC = 3 kHz
- (2) Any value between zero and the min threshold of the measurement range (0.15 V) is forced to **----** on the display.

Specific Specifications in MAX/MIN mode in voltage (from 10 Hz to 1 kHz in AC and AC+DC, and from 0.30 V):

- Accuracy: add 1 % R to the values in the tables above.
- Capture time of the extreme: approximately 100 ms.

Specific Specifications in PEAK mode in voltage (from 10 Hz to 1 kHz in AC and AC+DC):

- Accuracy: add 1.5 % R to the values in the tables above.
- PEAK capture time: 1 ms min to 1.5 ms max.

5.2.4 DC Current Measurement

Measurement Range⁽²⁾	(0.00 to 99.99) A	(100.0 to 999.9) A	(1000 to 3000) A ⁽¹⁾
Specified Measurement Range	(0 to 100) % of the measurement range		
Accuracy⁽²⁾ (zero corrected)	± (1 % R + 10 cts)	± (1 % R + 3 cts)	2000 A ± (1.5 % R + 3 cts) (2000 to 2500) ± (2.5 % R + 3 cts) (2500 to 3000) ± (3.5 % R + 3 cts)
Resolution	0.01 A	0.1 A	1 A

- (1) The display indicates **OL** above 6000 A and **-OL** below -6000 A in **REL** mode. The - and + signs are displayed (polarity).
- (2) The residual current at zero depends on the remanence. It can be corrected by the **DC zero** function of the **HOLD** button.

5.2.5 AC Current Measurement

Measurement Range⁽²⁾	(0.25 to 99.99) A	(100.0 to 999.9) A	(1000 to 2000) A ⁽¹⁾
Specified Measurement Range	(0 to 100) % of the measurement range		
Accuracy	± (1 % R + 10 cts)	± (1 % R + 3 cts)	± (1.5 % R + 3 cts)
Resolution	0.01 A	0.1 A	1 A

- (1) The display indicates **OL** above 3000 A in **PEAK** mode. The - and + signs are not displayed. Bandwidth in **AC** = 1 kHz
- (2) In **AC**, any value between zero and the min threshold of the measurement range (0.25 A) is forced to **-----** on the display.

5.2.6 AC+DC Intensity Measurement

Measurement Range⁽²⁾	(0.25 to 99.99) A	(100.0 to 999.9) A	AC: (1000 to 2000) A DC or PEAK: (1000 to 3000) A ⁽¹⁾
Specified Measurement Range	(0 to 100) % of the measurement range		
Accuracy⁽²⁾ (zero corrected)	$\pm (1\% R + 10 \text{ cts})$	$\pm (1\% R + 3 \text{ cts})$	up to 2000 A $\pm (1.5\% R + 3 \text{ cts})$ from 2000 to 2500 A _{DC} $\pm (2.5\% R + 3 \text{ cts})$ from (2500 to 3000) A _{DC} $\pm (3.5\% R + 3 \text{ cts})$
Resolution	0.01 A	0.1 A	1 A

(1) In **DC**, the display indicates **+OL** above +6000 A and **-OL** above -6000 A in **REL** mode. The + and - signs are displayed.

In **AC** and **AC+DC**, the display indicates **+OL** above 3000 A in **PEAK** mode. The - and + signs are not displayed.

Bandwidth in AC = 1 kHz

(2) In **AC**, any value between zero and the min threshold of the measurement range (0.25 A) is forced to **----** on the display.

Specific characteristics in MAX/MIN mode in current (from 10 Hz to 1 kHz in AC and AC+DC, and from 0.30 A):

- Accuracy (zero corrected): add 1 % R to the values in the tables above.
- Capture time of the extrema: approximately 100 ms.

Specific characteristics in PEAK mode in current (from 10 Hz to 1 kHz in AC and AC+DC):

- Accuracy: add $\pm (1.5\% R + 0.5 \text{ A})$ to the values in the tables above.
- PEAK capture time: 1 ms min to 1.5 ms max.

5.2.7 True InRush® Measurement

Measurement Range	20 A to 2000 A _{AC}	20 A to 3000 A _{DC}
Specified Measurement Range	(0 to 100) % of the measurement range	
Accuracy	$\pm (5\% R + 5 \text{ cts})$	
Resolution	1 A	

Specific Specifications in PEAK mode in True InRush® (from 10 Hz to 1 kHz in AC):

- Accuracy: add $\pm (1.5\% R + 0.5 \text{ A})$ to the values of the table above.
- PEAK capture time: 1 ms min to 1.5 ms max.

5.2.8 Continuity Measurement

Measurement Range	(0.0 to 999.9) Ω
Open-circuit Voltage	≤ 3.6 V
Measurement Current	550 μ A
Accuracy	$\pm (1 \% R + 5 \text{ cts})$
Buzzer Triggering Threshold	Adjustable from (1 to 999) Ω (40 Ω is the default)

5.2.9 Resistance Measurement

Measurement Range ⁽¹⁾	(0.0 to 99.9) Ω	(100.0 to 999.9) Ω	(1000 to 9999) Ω	(10.00 to 99.99) k Ω
Specified Measurement Range	(1 to 100) % of the measurement range		(0 to 100) % of the measurement range	
Accuracy	$\pm (1 \% R + 10 \text{ cts})$	$\pm (1 \% R + 5 \text{ cts})$		
Resolution	0.1 Ω		1 Ω	10 Ω
Open-circuit Voltage	≤ 3.6 V			
Measurement Current	550 μ A		100 μ A	10 μ A

(1) Above the maximum display value, the display unit indicates **OL**. The - and + signs are not displayed.

Specific Specifications in MAX/MIN mode:

- Accuracy: add 1 % R to the values of the table above.
- Capture time of the extreme: approximately 100 ms.

5.2.10 Diode Test

Measurement Range	(0.000 to 3.199) V _{DC}
Specified Measurement Range	(1 to 100) % of the measurement range
Accuracy	$\pm (1 \% R + 10 \text{ cts})$
Resolution	0.001 V
Measurement Current	0.55 mA
Indication: Junction reversed or open-circuit	OL is displayed when the measured voltage >3.199 V



NOTE: The - sign is disabled for the diode test function.

5.2.11 Active DC Power Measurements

Measurement Range⁽²⁾	(0 to 9.999) kW	(10.00 to 99.99) kW	(100.0 to 999.9) kW	(1000 to 5100) kW ⁽¹⁾
Specified Measurement Range	(1 to 100) % of the measurement range	(0 to 4800) kW		
Accuracy⁽³⁾	up to 1000 A ± (2 % R + 10 cts) (1000 to 2000) A ± (2.5 % R + 10 cts) (2000 to 2500) A _{DC} ± (3.5 % R + 10 cts) (2500 to 3000) A _{DC} ± (4.5 % R + 10 cts)	up to 1000 A ± (2 % R + 4 cts) (1000 to 2000) A ± (2.5 % R + 4 cts) (2000 to 2500) A _{DC} ± (3.5 % R + 4 cts) (2500 to 3000) A _{DC} ± (4.5 % R + 4 cts)		
Resolution	1 W	10 W	100 W	1000 W

- (1) Display of **OL** or **± OL** above ± 5100 kW, in **REL** mode.
- (2) Any applied voltage greater than 1700 V causes the emission of an intermittent alarm beep to report a dangerous overload.
- (3) The measurement result may be affected by an instability linked to the current measurement (approximately 0.1 A). Example: for a power measurement made at 10 A, the instability of the measurement will be 0.1 A / 10 A or 1 %.

5.2.12 Active AC Power Measurements

Measurement Range^{(2) (4)}	(5 to 9.999) kW	(10.00 to 99.99) kW	(100.0 to 999.9) kW	(1000 to 2400) kW ⁽¹⁾
Specified Measurement Range	(1 to 100) % of the measurement range	(0 to 100) % of the measurement range		
Accuracy^{(3) (7)}	up to 1000 A ± (2 % R + 10 cts) (1000 to 2000) A ± (2.5 % R + 10 cts)	up to 1000 A ± (2 % R + 4 cts) (1000 to 2000) A ± (2.5 % R + 4 cts)		
Resolution	1 W	10 W	100 W	1000 W

- (1) Bandwidth in **AC**: in voltage = 3 kHz, in current = 1 kHz
- (2), and (3) of the previous § apply.
- (4) Any power measured less than 5 W causes the display of dashes **-----**.
If the voltage is less than 0.15 V or if the current is less than 0.15 A, causes the display of dashes **-----**.
- (7) In balanced three-phases, with deformed signals (THD and harmonics), accuracies are guaranteed since $\Phi > 30^\circ$. Additional errors are following, depending of THD:
 Add + 1 % for 10 % < THD < 20 %
 Add + 3 % for 20 % < THD < 30 %
 Add + 5 % for 30 % < THD < 40 %



NOTE 5: The active power are positive for power consumed and negative for power generated.

NOTE 6: The signs of the active and reactive powers and power factor are defined by the four-quadrant rule below.
The diagram below sums up the signs of the power as a function of the phase angle between V and I:



- Quadrant 1:** Active power P sign + (power consumed)
- Quadrant 2:** Active power P sign - (power generated)
- Quadrant 3:** Active power P sign - (power generated)
- Quadrant 4:** Active power P sign + (power consumed)

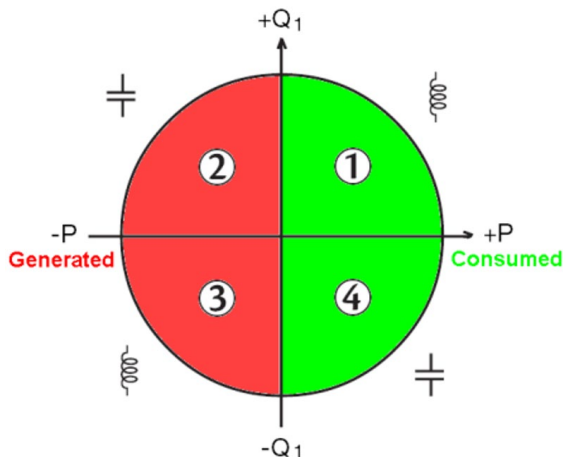

5.2.13 Active AC+DC Power Measurements

Measurement Range ^{(2) (4)}	(5 to 9.999) kW	(10.00 to 99.99) kW	(100.0 to 999.9) kW	(1000 to 5100) kW ⁽¹⁾
Specified Measurement Range	(1 to 100) % of the measurement range	(0 to 4800) kW		
Accuracy ^{(3) (7)}	up to 1000 A $\pm (2 \% R + 10 \text{ cts})$ (1000 to 2000) A $\pm (2.5 \% R + 10 \text{ cts})$ (2000 to 2500) A _{DC} $\pm (3.5 \% R + 10 \text{ cts})$ (2500 to 3000) A _{DC} $\pm (4.5 \% R + 10 \text{ cts})$	up to 1000 A $\pm (2 \% R + 4 \text{ cts})$ (1000 to 2000) A $\pm (2.5 \% R + 4 \text{ cts})$ (2000 to 2500) A _{DC} $\pm (3.5 \% R + 4 \text{ cts})$ (2500 to 3000) A _{DC} $\pm (4.5 \% R + 4 \text{ cts})$		
Resolution	1 W	10 W	100 W	1000 W

(1) Bandwidth in AC: in voltage = 3 kHz, in current = 1 kHz

(2), (3), (4), 5, 6 and (7) of the previous § apply.

5.2.14 Measurement of Apparent AC Power

Measurement Range^{(2) (4)}	(5 to 9.999) kVA	(10.00 to 99.99) kVA	(100.0 to 999.9) kVA	(1000 to 2400) kVA ⁽¹⁾
Specified Measurement Range	(1 to 100) % of the measurement range	(0 to 2200) kVA		
Accuracy⁽³⁾	up to 1000 A ± (2 % R + 10 cts) (1000 to 2000) A ± (2.5 % R + 10 cts)	up to 1000 A ± (2 % R + 4 cts) (1000 to 2000) A ± (2.5 % R + 4 cts)		
Resolution	1 VA	10 VA	100 VA	1000 VA

(1) Bandwidth in AC: in voltage = 3 kHz, in current = 1 kHz

(2), (3) and (4) of the previous § apply.

5.2.15 Measurement of Apparent AC+DC Power

Measurement Range^{(2) (4)}	(5 to 9.999) kVA	(10.00 to 99.99) kVA	(100.0 to 999.9) kVA	(1000 to 5100) kVA ⁽¹⁾
Specified Measurement Range	(1 to 100) % of the measurement range	(0 to 100) % of the measurement range		
Accuracy⁽³⁾	up to 1000 A ± (2 % R + 10 cts) (1000 to 2000) A ± (2.5 % R + 10 cts) (2000 to 2500) A _{DC} ± (3.5 % R + 10 cts) (2500 to 3000) A _{DC} ± (4.5 % R + 10 cts)	up to 1000 A ± (2 % R + 3 cts) (1000 to 2000) A ± (2.5 % R + 3 cts) (2000 to 2500) A _{DC} ± (3.5 % R + 3 cts) (2500 to 3000) A _{DC} ± (4.5 % R + 3 cts)		
Resolution	1 VA	10 VA	100 VA	1 000 VA

(1) Display of O.L above 5100 kVA in **single-phase** (1700 V x 3000 A).

Bandwidth in AC: in voltage = 3 kHz, in current = 1 kHz

(2), (3) and (4) of the previous § apply.

5.2.16 Measurement of Reactive AC Power

Total reactive power $Q = \sqrt{(S^2 - P^2)}$

where S = apparent power
and P = active power

Measurement Range ^{(2) (4)}	(5 to 9.999) kvar	(10.00 to 99.99) kvar	(100.0 to 999.9) kvar	(1000 to 2400) kvar ⁽¹⁾
Specified Measurement Range	(1 to 100) % of the measurement range	(0 to 2200) kvar		
Accuracy ^{(3) (8)}	up to 1000 A ± (2 % R + 10 cts) from (1000 to 2000) A ± (2.5 % R + 10 cts)	up to 1000 A ± (2 % L + 4 cts) from (1000 to 2000) A ± (2.5 % L + 4 cts)		
Resolution	1 var	10 var	100 var	1 kvar

(1) *Bandwidth in AC: in voltage = 3 kHz, in current = 1 kHz.*

(2), (3) and (4) of the previous § apply.

(8) In **single-phase**, with deformed signals (THD and harmonics), accuracies are guaranteed since $\Phi > 30^\circ$. Additional errors are following, depending of THD:

Add + 1 % for $10\% < THD < 20\%$

Add + 3 % for $20\% < THD < 30\%$

Add + 5 % for $30\% < THD < 40\%$



NOTE 5: In single-phase, the sign of the reactive power is determined by the phase lead or lag between the V and I signs, while in balanced three-phase, it is determined by the calculation on the samples.

NOTE 6: Signs of reactive powers according to the four-quadrant rule (see § 5.2.12.1):



Quadrant 1: Reactive power Q sign +

Quadrant 2: Reactive power Q sign +

Quadrant 3: Reactive power Q sign -

Quadrant 4: Reactive power Q sign -

5.2.17 Measurement of Reactive AC+DC Power

$$\text{Total reactive power } Q = \sqrt{(S^2 - P^2)}$$

where S = apparent power
and P = active power

Measurement Range^{(2) (4)}	(5 to 9.999) kvar	(10.00 to 99.99) kvar	(100.0 to 999.9) kvar	(1000 to 5100) kvar ⁽¹⁾
Specified Measurement Range	(1 to 100) % of the measurement range	0 to 100 % of the measurement range		
Accuracy^{(3) (8)}	up to 1000 A ± (2 % R + 10 cts) (1000 to 2000) A ± (2.5 % R + 10 cts) (2000 to 2500) A _{DC} ± (3.5 % R + 10 cts) (2500 to 3000) A _{DC} ± (4.5 % R + 10 cts)	up to 1000 A ± (2 % R + 4 cts) (1000 to 2000) A ± (2.5 % R + 4 cts) (2000 to 2500) A _{DC} ± (3.5 % R + 4 cts) (2500 to 3000) A _{DC} ± (4.5 % R + 4 cts)		
Resolution	1 var	10 var	100 var	1 kvar

(1) Display of **O.L** above 5100 kvar in **single-phase** (1700 V x 3000 A).
Bandwidth in **AC**: in voltage = 3 kHz, in current = 1 kHz.

(2), (3), (4), 5, 6 and (8) of the previous § apply.

Specific Specifications in MAX/MIN mode in power (from 10 Hz to 1 kHz):

- Accuracy: add 1 % R to the values of the table above.
- Capture time: approximately 100 ms.

5.2.18 Calculation of the Power Factor

Measurement Range⁽¹⁾	- 1.00 to + 1.00	
Specified Measurement Range	(0 to 50) % of the measurement range	(50 to 100) % of the measurement range
Accuracy⁽⁷⁾	± (3 % R + 3 cts)	± (2 % R + 3 cts)
Resolution	0.01	

(1) If one of the terms in the calculation of the power factor is displayed as **O.L.**, or forced to **zero**, the display of the power factor is an indeterminate value **----**.

(7), of the previous § applies.

NOTE 9: Sign of the power factor according to the four-quadrant rule (see § 5.2.12.1):



Quadrant 1:	Power factor PF Cos Φ	sign + (inductive system) sign +
Quadrant 2:	Power factor PF Cos Φ	sign - (capacitive system) sign -
Quadrant 3:	Power factor PF Cos Φ	sign + (inductive system) sign -
Quadrant 4:	Power factor PF Cos Φ	sign - (capacitive system) sign +

Specific characteristics in MAX/MIN mode (from 10 Hz to 1 kHz):

- Accuracy: add 1 % R to the values in the tables above.
- Capture time: approximately 100 ms.

5.2.19 Frequency Measurement

5.2.19.1 Voltage

Measurement Range ⁽¹⁾	(5.0 to 999.9) Hz	(1000 to 9999) Hz	(10.00 to 19.99) kHz
Specified Measurement Range	(1 to 100) % of the measurement range		(0 to 100) % of the measurement range
Accuracy	± (0.4 % R + 1 ct)		
Resolution	0.1 Hz	1 Hz	10 Hz

(1) If the level of the signal is too low ($U < 3\text{ V}$ or $I < 3\text{ A}$) or if the frequency is less than 5 Hz, the device cannot determine the frequency and displays dashes **----**.

5.2.19.2 Current

Measurement Range ⁽¹⁾	(5.0 to 999.9) Hz
Specified Measurement Range	(1 to 100) % of the measurement range
Accuracy	± (0.4 % R + 1 ct)
Resolution	0.1 Hz

(1) If the level of the signal is too low ($U < 3\text{ V}$ or $I < 3\text{ A}$) or if the frequency is less than 5 Hz, the device cannot determine the frequency and displays dashes **----**.

Specific characteristics in MAX/MIN mode (from 10 Hz to 1 kHz in voltage and from 10 Hz to 1 kHz in current):

- Accuracy: add 1 % R to the values of the table above.
- Capture time of the extrema: approximately 100 ms.

5.2.20 Specifications in THDr

Measurement Range	(0.0 to 100) %
Specified Measurement Range	(0 to 100) % of the measurement range
Accuracy	$\pm (5 \% R + 2 \text{ cts})$ in voltage $\pm (5 \% R + 5 \text{ cts})$ in current
Resolution	0.1 %

5.2.21 Specifications in THDf

Measurement Range	(0.0 to 1000) %
Specified Measurement Range	(0 to 100) % of the measurement range
Accuracy	$\pm (5 \% R + 2 \text{ cts})$ in voltage $\pm (5 \% R + 5 \text{ cts})$ in current
Resolution	0.1 %



NOTE: The display is ---- if the input signal is too low ($V < 8 \text{ V}$ or $I < 9 \text{ A}$) or if the frequency is less than 5 Hz.

Specific characteristics in MAX/MIN mode in THD (from 10 Hz to 1 kHz):

- Accuracy: add 1 % R to the values of the tables above.
- Capture time of the extrema: approximately 100 ms.

5.2.22 Indication of Order of the Phases

Frequency range	(47 to 400) Hz
Acceptable voltage range	(50 to 1200) V
Acquisition duration period	$\leq 500 \text{ ms}$
Validity duration period	approximately 10 s to 50 Hz approximately 2 s to 400 Hz
Acquisition duration measurement period	$\leq 500 \text{ ms}$
Acceptable phase unbalance	$\pm 10^\circ$
Acceptable amplitude unbalance	20 %
Acceptable level of harmonics in voltage	10 %

5.3 ENVIRONMENTAL CONDITIONS

Conditions	Operating	Storage
Temperature	(-4 to +131) °F (-20 to +55) °C	(-40 to +158) °F (-40 to +70) °C
Relative Humidity (RH)	$\leq 90 \%$ to 131 °F ($\leq 90 \%$ to 55 °C)	$\leq 90 \%$ to 158 °F ($\leq 90 \%$ to 70 °C)

5.4 MECHANICAL SPECIFICATIONS

Housing	Rigid polycarbonate shell with over-molded elastomer covering; UL94 V1
Jaws	Polycarbonate Opening: 2.4 in (60 mm) Clamping diameter: 2.4 in (60 mm)
Screen	LCD display unit Blue backlighting Dimensions: 1.6 x 1.9 in (41 x 48 mm)
Dimension	(11.7 x 4.4 x 1.6) in (296 x 111 x 41) mm
Weight	1.41 lbs (640 g) with the batteries

5.5 POWER SUPPLY

Batteries	4 x 1.5 V AA LR6
Battery Life	>350 h (without backlighting)
Auto Power Off	After 10 min with no switch and/or button activity

5.6 COMPLIANCE WITH INTERNATIONAL STANDARDS

Electric Safety	Compliant with standards IEC/EN 61010-1 or BS EN 61010-1, IEC/EN 61010-2-032 or BS EN 61010-2-032: 1000 V CAT IV and 1500 V CAT III
Electromagnetic Compatibility	Compliant with standard IEC/EN-61326-1 or BS EN 61326-1 Classification: residential environment
Mechanical Strength	Free fall: 6.6 ft (2 m) (in accordance with standard IEC-68-2-32)
Level of Protection	Housing: IP54 (per standard IEC-60529) Jaws: IP40

5.7 ENVIRONMENTAL VARIATIONS

Condition of Influence	Range of Influence	Measurement Influenced	Influence	
			Typical	MAX
Temperature	(-4 to +131) °F (-20 to +55) °C	V _{AC}	-	0.1 % R / 10 °C
		V _{DC}	0.1 % R / 10 °C	0.5 % R / 10°C + 2 cts
		A*	1 % R / 10 °C*	1.5 % R / 10°C + 2 cts*
		$\Omega \rightarrow \rightarrow \rightarrow$	-	0.1 % R / 10°C + 2 cts
		W _{AC}	-	0.2 % R / 10°C + 1 ct
		W _{DC}	0.15 % R / 10 °C	0.3 % R / 10°C + 2 cts
Humidity	(10 to 90) % RH	V	≤ 1 ct	0.1 % R + 1 ct
		A	-	0.1 % R + 2 cts
		$\Omega \rightarrow \rightarrow \rightarrow$	0.2 % R	0.3 % R + 2 cts
		W	0.25 % R	0.5 % R + 2 cts

Condition of Influence	Range of Influence	Measurement Influenced	Influence	
			Typical	MAX
Frequency	10 Hz to 1 kHz (1 to 3) kHz (10 to 400) Hz 400 Hz to 2 kHz	V	1 % R + 1 ct 8 % R + 1 ct	1 % R + 1 ct 9 % R + 1 ct
		A	1 % R + 1 ct 4 % R + 1 ct	1 % R + 1 ct 5 % R + 1 ct
Position of the conductor in the jaws (f ≤ 400 Hz)	Any position on the internal perimeter of the jaws	A-W (<2000 A _{DC} or 1400 A _{DC}) (>2000 A _{DC})	2 % R 4 % R + 1 ct	8 % R
Adjacent conductor carrying a current of 150 A DC or RMS	Conductor touching the external perimeter of the jaws	A-W	35 dB	42 dB
Conductor enclosed by the clamp	(0 to 500) A _{DC} or A _{RMS}	V	< 1 ct	1 ct
Application of a voltage on the clamp	(0 to 1600) V _{DC} or RMS	A-W	< 1 ct	1 ct
Peak factor	1.4 to 3.5 limited to 3000 A peak 1600 V peak	A (AC-AC+DC) V (AC-AC+DC)	1 % R 1 % R	3 % R + 1 ct 3 % R + 1 ct

* in Temperature for measurement A: Influence specified until 1000 A_{DC}

6. MAINTENANCE

The device does not contain any parts that can be replaced by untrained or unaccredited personnel. Any unauthorized work or part replacement with **equivalents** may seriously compromise safety.

6.1 WARNING

- Remove the test leads on any input before opening the case.
- Do not operate the clamp-on meter without a battery case cover.
- To avoid electrical shock, do not attempt to perform any servicing unless you are qualified to do so.
- To avoid electrical shock and/or damage to the instrument, do not get water or other foreign agents into the probe.

6.2 CLEANING

- Disconnect everything connected to the device and set the rotary switch to **OFF**.
- Use a soft cloth moistened with soapy water.
- Rinse with a damp cloth and dry quickly using a dry cloth or forced air.
- Dry completely before putting back into use.

6.3 REPLACEMENT OF THE BATTERIES

The  symbol indicates that the batteries are low. When this symbol appears on the display unit, the batteries must be replaced. The measurements and specifications are no longer guaranteed.

To replace the batteries:

1. Disconnect the measurement leads from the input terminals.
2. Set the rotary switch to **OFF**.
3. Using a screwdriver, unscrew the battery compartment cover from the back of the housing (see § 4.1).
4. Remove the used batteries and replace them with (4) 1.5 V AA batteries, observing the polarities.
5. Close the battery compartment cover and screw it onto the housing.

6.4 REPAIR AND CALIBRATION

To ensure that your instrument meets factory specifications, we recommend that it be sent back to our factory Service Center at one-year intervals for recalibration or as required by other standards or internal procedures.

For instrument repair and calibration:

You must contact our Service Center for a Customer Service Authorization Number (CSA#). Send an email to repair@aemc.com requesting a CSA#, you will be provided a CSA Form and other required paperwork along with the next steps to complete the request. Then return the instrument along with the signed CSA Form. This will ensure that when your instrument arrives, it will be tracked and processed promptly. Please write the CSA# on the outside of the shipping container. If the instrument is returned for calibration, we need to know if you want a standard calibration or a calibration traceable to N.I.S.T. (includes calibration certificate plus recorded calibration data).

Ship To: Chauvin Arnoux®, Inc. d.b.a. AEMC® Instruments
15 Faraday Drive ▪ Dover, NH 03820 USA
Phone: (800) 945-2362 (Ext. 360) / (603) 749-6434 (Ext. 360)
Fax: (603) 742-2346
E-mail: repair@aemc.com

(Or contact your authorized distributor.)

Contact us for the costs for repair, standard calibration, and calibration traceable to N.I.S.T.



NOTE: You must obtain a CSA# before returning any instrument.

6.5 TECHNICAL ASSISTANCE

If you are experiencing any technical problems or require any assistance with the proper operation or application of your instrument, please call, e-mail or fax our technical support team:

Chauvin Arnoux®, Inc. d.b.a. AEMC® Instruments
Phone: (800) 343-1391 (Ext. 351)
Fax: (603) 742-2346
E-mail: techsupport@aemc.com
www.aemc.com

6.6 LIMITED WARRANTY

The instrument is warranted to the owner for a period of three years from the date of original purchase against defects in manufacture. This limited warranty is given by AEMC® Instruments, not by the distributor from whom it was purchased. This warranty is void if the unit has been tampered with, abused, or if the defect is related to service not performed by AEMC® Instruments.

Full warranty coverage and product registration is available on our website at www.aemc.com/warranty.html

Please print the online Warranty Coverage Information for your records.

What AEMC® Instruments will do:

If a malfunction occurs within the warranty period, you may return the instrument to us for repair, provided we have your warranty registration information on file or a proof of purchase. AEMC® Instruments will repair or replace the faulty material at our discretion.

REGISTER ONLINE AT: www.aemc.com/warranty.html

6.6.1 Warranty Repairs

What you must do to return an Instrument for Warranty Repair:

First, send an email to repair@aemc.com requesting a Customer Service Authorization Number (CSA#) from our Service Department. You will be provided a CSA Form and other required paperwork along with the next steps to complete the request. Then return the instrument along with the signed CSA Form. Please write the CSA# on the outside of the shipping container. Return the instrument, postage or shipment prepaid to:

Chauvin Arnoux®, Inc. d.b.a. AEMC® Instruments
15 Faraday Drive, Dover, NH 03820 USA
Phone: (800) 945-2362 (Ext. 360)
(603) 749-6434 (Ext. 360)
Fax: (603) 742-2346
E-mail: repair@aemc.com

Caution: To protect yourself against in-transit loss, we recommend that you insure your returned material.



NOTE: You must obtain a CSA# before returning any instrument.

NOTES:



03/24
99-MAN 100585 v00

AEMC[®] Instruments
15 Faraday Drive • Dover, NH 03820 USA
Phone: +1 (603) 749-6434 • +1 (800) 343-1391 • Fax: +1 (603) 742-2346
www.aemc.com
