

PXR Series

Advanced Self-Tuning Temperature and Process Controllers

FUJI PXR SERIES CONTROLLERS

Key Features

- PID with fuzzy control of self-tuning
- 16 Ramp/soak segments
- Large LED display
- Digital input
- Auto-tune
- Timer function
- Heater burnout alarm
- Replaces most other controllers in market
- Excellent for after-market support

The new PXR series controllers are the newest additions to Fuji Electric's trusted line of temperature and process controllers. They are now packed with more features and options than before, and the new low price is unbeatable.

They come in several sizes – 1/32 DIN, 1/16 DIN, 1/8 DIN and 1/4 DIN. These controllers have all the standard features that you expect from Fuji Electric's superior controllers, and more. In addition to auto-tuning and fuzzy control, it now comes with self-tuning — an innovation in the control field. It automatically retunes the controller under certain conditions, without the need to revert to auto-tuning. The standard 8-segment ramp/soak feature has been expanded to include two patterns that can be linked to create a 16-step profile. The PXR accepts temperature and process inputs and offers a choice of three kinds of outputs to meet a wide variety of needs in the process industries. Low-cost options include dual outputs, programmable alarms, remote setpoint, RS485 communications, analog retransmission, digital input, timer function, heater burnout alarm and 24V AC/DC supply voltage.

One of the most impressive features is the large LED display. The faceplate, designed for NEMA 4X (IP66 equivalent) is watertight and corrosion-resistant. The easy-to-use 3-button keypad allows for programming similar to the popular PXW controller. The screw-terminal on the back further reduces the cost by eliminating the need for sockets. The PXR3 can be DIN-rail mounted with the optional adapter.

Remote monitoring of up to 31 controllers at a time is possible with the RS485 option that uses the industry-standard Modbus™ protocol. The communications option comes with our free Windows®-based software, PXR-LITE™. The software allows you to program the controller from the PC and view real-time data and trend graph while logging the data into a text file.

A powerful tool for the OEM customer is the Program Loader option with Windows®-based software. Programs for different applications can be saved to and from the controller.

Features

- **Advanced control functions** PID Plus Self Tuning; PID Plus Fuzzy Control; Auto-tuning
- **NEMA 4X faceplate with large LED display** 4-digit, red and green display; Waterproof faceplate conforms to NEMA-4X/IP66
- **Multiple inputs** Choose between thermocouple/RTD and 4-20mA/0-5V inputs
- **Single or dual control outputs** Relay, SSR driver or 4-20mA
- **Ramp/soak function** Up to 16 ramp/soak segments or two 8-segment patterns, a standard feature
- **Programmable alarms option** 2 programmable SPST relays with On/Off delay function
- **Remote setpoint option** Change setpoint with a 1-5V signal
- **Analog retransmission option** 4-20mA retransmission of PV, SV, MV, DV
- **Digital input option** Change between 2 setpoints; Change between ramp/soak and standby; Start/reset the ramp/soak; Start/stop the auto tuning; Cancel the alarm latch; Start the incorporated timer
- **Timer function** On-delay or off-delay timer activated with digital input; Up to 2 timer outputs can be obtained
- **Heater burnout alarm option** If heater burns out, alarm goes off
- **Communications option** RS485 (Modbus™ protocol) interface permits remote monitoring of up to 31 units from a PC. Comes with free Windows®-based software, PXR-LITE™
- **Warranty** Manufactured in a ISO 9001 facility and backed by a 3-year warranty



Specifications

General Specifications

Power supply voltage 100 (-15%) to 240V (+10%) AC, 50/60Hz; 24V ($\pm 10\%$) AC/DC

Power consumption PXR3: 6VA (100V AC), 8VA (220V, 24V). PXR4: 8VA (100V), 10VA (220V), 12VA (24V). PXR5, 9: 10VA (100V), 12VA (220V, 24V)

Reference junction compensation accuracy $\pm 1^\circ\text{C}$ at 23°C

Input

Input signal Thermocouple: J, K, R, B, S, T, E, N, PL2. RTD: Pt100. Voltage, current. For 1 to 5V/4 to 20 mA DC, 0 to 5V/0 to 20 mA DC, use 250 ohm shunt resistor included

Input filter 0 to 900.0 sec set in 0.5 sec steps

Burnout For thermocouple or RTD input, control output direction (upper or lower) is selectable

Control Function

Control action On/Off; PID control (with auto-tuning, self-tuning); Fuzzy Control (with auto-tuning)

Proportional band (P) 0 to 999.9% of measuring range set in 0.1% steps

Integral time (I) 0 to 3200 sec set in 1 sec steps

Differential time (D) 0 to 999.9 sec set in 1 sec steps

Proportional cycle 1 to 150 sec set in 1 sec steps

Hysteresis width 0 to 50% of measuring range; For on/off action only

Input sampling cycle 0.5 sec

Control Output 1 (select one)

Relay contact PXR4, 5, 9: SPDT, 220 V AC/30 V DC, 3A (resistive load). PXR3: SPST contact, 220 V AC/30 V DC, 3A (resistive load)

SSR PXR4, 5, 9: ON-17 to 25 V DC; OFF-0.5 V DC or less. PXR3: 12 to 16 V DC. Max. current: 20mA or less

4 to 20 mA DC PXR4, 5, 9: Allowable load resistance 600 ohms or less. PXR3: 100 to 500 ohms

Control Output 2 (Heating/Cooling Control) (select one)

Relay contact SPST, 220 V AC/30 V DC, 3A (resistive load)

SSR PXR4, 5, 9: ON-17 to 25 V DC; OFF-0.5 V DC or less. PXR3: 12 to 16 V DC. Max. current: 20mA or less

4 to 20 mA DC PXR4, 5, 9: Allowable load resistance 600 ohms or less. PXR3: 100 to 500 ohms

Program Loader Interface

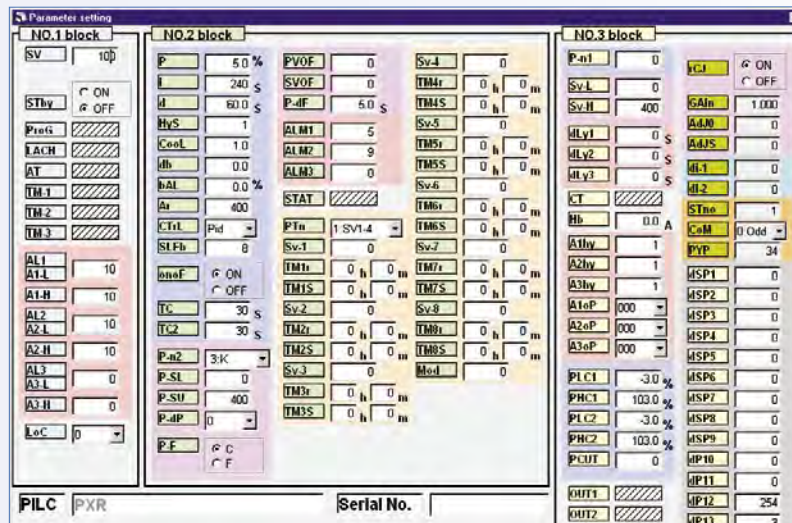

The Program Loader for Fuji Electric's PX and PXR series controllers is a powerful tool for the OEM customer. Using the PXR4 Loader Assembly, the controller can be configured from a PC running on Windows environment.

Features

- Retrieve or store controller data
- Selectively mask or unmask parameters for viewing on the controller
- Clone settings to other controllers from saved files
- Print data report

PXR LITE Communications Software

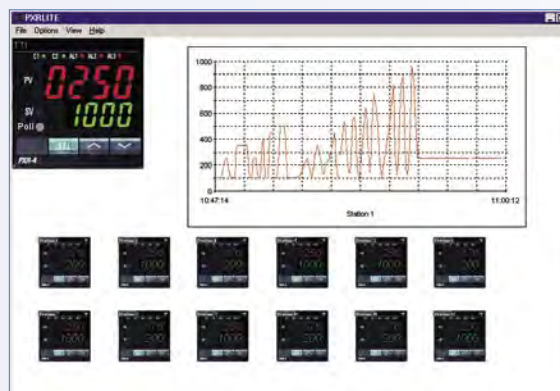

PXR-LITE™ is free Windows®-based software that is supplied with the communications option on a PXR controller. It is the latest in control and monitoring of Fuji Electric's PXR series controllers. It provides continuous remote monitoring of single or multiple controllers using a single half-duplex RS485 line.

Features

- Monitor and control up to 31 controllers from a PC via RS485-RS232 signal converter

- Real-time charting and data-logging
- Remote setpoint adjustment
- Set control modes, alarms and other control parameters
- Remote auto-tuning and ramp-soak programming
- Live display of process and setpoint values, alarm annunciators
- View single-station or multi-station data
- Comprehensive help file included
- Runs on Windows environment, version 3.1 or later

Operation and Display Section

Parameter setting method Digital setting by 3 keys; Key lock function provided

Display unit Process value/set value displayed individually 4 digits, 7-segment LED

Status display LED Control output, process alarm output, heater burnout alarm output

Indication accuracy (at 23°C) Thermocouple: \pm (0.5% of measuring range) \pm 1 digit \pm 1°C. For thermocouple R at 0 to 500°C: \pm (1% of measuring range) \pm 1 digit \pm 1°C. For thermocouple B at 0 to 400°C: \pm (5% of measuring range) \pm 1 digit \pm 1°C. RTD, voltage/current: \pm (0.5% of measuring range) \pm 1 digit

Alarm (option)

Alarm type Absolute alarm, deviation alarm, zone alarm with upper and lower limits for each; hold function available; alarm latch function provided

Alarm ON-delay Delay setting 0 to 9999 sec set in 1 sec steps

Process alarm output Relay contact: SPST, 220 V AC/30 V DC, 1A (resistive load); Max. 2 points (PXR3), max. 3 points (PXR4, 5, 9)

Heater burnout option (not available on PXR3) Alarm setting range: 1 to 50A Available only when control output is relay or SSR drive.

Heater burnout alarm output Relay contact: SPST, 220 V AC/30 V DC, 1A (resistive load); 1 output point

Current detector CTL-6-S for 1 to 30 A; CTL-12 for 20 to 50 A

Digital Input (option)

Points 1 or 2; contact closure. 5 V DC, approx. 2mA

Function (select one) Set value (SV, SV1 to 3) changeover, start/stop control action, start/reset ramp/soak action, start/stop auto-tuning, cancel alarm latch, start incorporated timer

Retransmission Output (option)

Output signal 4-20 mA DC

Load resistance 500 ohms or less

Output accuracy \pm 0.3% FS

Output selection PV, SV, MV, DV (SV-PV)



PXR4 Terminal Cover (option)



PXR3 DIN Rail Adapter

Timer Function (option)

Start By digital input option

Setting 0 to 9999 sec set in 1 sec steps

Action Event ON-delay or OFF-delay

Signal output Alarm output relays used; 2 points are available

Communication Function (option)

Physical specifications EIA RS485

Communication protocol Modbus (RTU).

Free Windows®-based software, PXR-LITE™

Communication method 2-wire method; half-duplex, bit serial, start-stop sync type

Data type 8 bits. Parity: odd/even/none

Communication rate 9600 bps

Connection aspect Multi-drop up to 31 controllers

Communication distance Total extension 500m or less

RS232C/RS485 signal converter RSFC24 (recommended, see ordering information)

Remote Setpoint Option

Input signal 1 to 5 V DC, 1 point

Accuracy \pm 0.5% \pm 1 digit

Input sampling cycle 0.5 sec

Display of remote mode LED on front panel

Input impedance 1M ohms or more

Other Functions

Parameter mask function Parameter display can be disabled from keypad

Ramp/soak function 8 ramps and 8 soaks; 1 or 2 program patterns; digital input allows start/reset of the action

Operating and Storage Conditions

Ambient operating temperature 14 to 122°F (-10 to 50°C)

Ambient operating humidity Less than 90% RH (no condensation)

Storage temperature -4 to 140°F (-20 to 60°C)

Structure

Mounting method Panel flush mounting. PXR3 can be DIN-rail mounted using the optional adapter

External terminal Screw terminal

Dimensions PXR3: 1 x 2 x 4 in. (24 x 48 x 98mm). PXR4: 1.89 x 1.89 x 3.37 in. (48 x 48 x 79.8 mm). PXR5: 2.07 x 3.96 x 3.77 in. (52.5 x 100.5 x 95.8 mm). PXR9: 3.96 x 3.96 x 3.77 in (100.5 x 100.5 x 95.8 mm)

Protective structure Front panel NEMA4X (IEC standard IP66 equivalent) (when mounted on panel with supplied gasket). Rear case: IEC IP20

Outer color Black (front panel, case)

Agency approvals UL, c-UL recognized (UL873), CSA (C22.2 No.24-93), CE certified (LVD:EN61010-1, EMC:1326-1)

Optional Items

Current transformer For 1 to 30 A: CTL-6-S. For 20 to 50 A: CTL-12

Signal converter for communication function RSFC24

DIN Rail adapter For PXR3 only

Terminal cover For PXR4 only

Ordering Information (PXR3)

P X R A - B C D 1 - E F G A 1

To create a part number fill in the boxes above with the appropriate number and/or letter from the corresponding list below.

Box A: Front Panel Size

3 = 1/32 DIN (24x48mm) \$159

Box B: Input Signal

T = Thermocouple (°C) N/C
 R = Thermocouple (°F) N/C
 N = RTD, Pt100 ohm, 3-wire type (°C) N/C
 S = RTD, Pt100 ohm, 3-wire type (°F) N/C
 B = 4-20mA DC, 1-5V DC N/C
 A = 0-20mA DC, 0-5V DC N/C

Box C: Control Output 1

A = Relay contact output N/C
 C = SSR or SSC drive output N/C
 E = 4-20mA DC output N/C

Box D: Control Output 2

Y = None N/C
 A = Relay contact output \$ 40
 C = SSR or SSC drive output 40
 E = 4-20mA DC output 40

Box E: Alarm Options

4 = None N/C
 5 = High/low alarm 1 point 35
 G = High/low alarm 2 points¹ 45

Box F: Power Supply

V = Standard (100-240 VAC, 50/60Hz) N/C
 B = 24V AC/DC (50/60Hz) 35

Box G: Additional Functions

0 = None N/C
 M = RS485 communication (Modbus) \$ 45
 Q = Retransmission + DI 1 point 65
 R = Retransmission (4-20mA DC) 55
 T = Digital Input (DI) x 2 35
 V = RS485 communications (Modbus)
 + DI 75

Note: RS485 option comes with Free software, PXR-LITE. RS485 requires signal converter to connect to PC, P/N RSFC24 recommended.

¹High/low alarm 2 points not available when control output 2 is selected.

Ordering Information (PXR4, PXR5, PXR7, PXR9)

P X R A - B C D 1 - E F G A 1

To create a part number fill in the boxes above with the appropriate number and/or letter from the corresponding list below.

Box A: Front Panel Size

4 = 1/16 DIN (48x48mm) \$189
 5 = 1/8 DIN (48x96mm) 239
 7 = 72 x 72mm 239
 9 = 1/4 DIN (96x96mm) 259

Box B: Input Signal

T = Thermocouple (°C) N/C
 R = Thermocouple (°F) N/C
 N = RTD, Pt100 ohm, 3-wire type (°C) N/C
 S = RTD, Pt100 ohm, 3-wire type (°F) N/C
 B = 4-20mA DC, 1-5V DC N/C
 A = 0-20mA DC, 0-5V DC N/C

Box C: Control Output 1

A = Relay contact output N/C
 C = SSR or SSC drive output N/C
 E = 4-20mA DC output¹ N/C
 G = Triac 1A, 250 VAC⁴ \$40

Box D: Control Output 2

Y = None N/C
 A = Relay contact output \$ 40
 C = SSR or SSC drive output 40
 E = 4-20mA DC output¹ 40
 G = Triac 1A, 250 VAC⁴ 40
 R = Retransmission (4-20mA DC) 55

Box E: Alarm Options

4 = None N/C
 6 = Heater break alarm^{1,2} 55
 G = High/low alarm 2 points 35
 H = High/low alarm 2 points +
 heater break alarm^{1,2} 85
 M = Alarm 3 points 55
 D = Remote setpoint³ 85
 P = Remote setpoint + alarm 2 points³ 11 5

Box F: Power Supply

V = Standard (100-240V AC, 50/60Hz) N/C
 B = 24V AC/DC (50/60Hz) \$ 35

Box G: Additional Functions

0 = None N/C
 M = RS485 communication (Modbus) 45
 S = Digital Input (DI) x 1 35
 T = Digital Input (DI) x 2¹ 35
 V = RS485 communications (Modbus)
 + DI^{1,3} 75

Note: RS485 option comes with Free software, PXR-LITE. RS485 requires signal converter to connect to PC, P/N RSFC24 recommended.

¹Heater break option not available with 4-20mA output, or with 2 digital inputs, or with RS485 +1 digital input.

²Must order current transformer CTL-6-S or CTL-12 with heater break option.

³Remote setpoint option not available with RS485 +1 digital input.

⁴UL and c-UL not available with PXR5 or PXR9.

Accessories

CTL-6-S	Current transformer for 1-30A	\$ 23
CTL-12	Current transformer for 20-50A	40
RSFC24	RS485 to RS232 signal converter	135
PXR4 Loader Assembly	Program loader for PXR4 (can be used for PX series also)	350
PXR3 Rail Adapter	Mounting adapter for DIN rail installation	15
PXR4 Terminal Cover	Terminal block protective cover	15

Information subject to change without notice. Prices in USD.

010110

PXR4 Temperature Controller Socket Series

Ordering Information (PXR4 Socket Version)

P X R 4 - A B S 1 - C D 0 A 1

To create a part number fill in the boxes above with the appropriate number and/or letter from the corresponding list below.

Front Panel Size

4 = 1/16 DIN (48x48mm) \$189

Box A: Input Signal

T = Thermocouple (°C) N/C
 R = Thermocouple (°F) N/C
 N = RTD, Pt100 ohm, 3-wire type (°C) N/C
 S = RTD, Pt100 ohm, 3-wire type (°F) N/C
 B = 4-20mA DC, 1-5V DC N/C
 A = 0-20mA DC, 0-5V DC N/C

Box C: Alarm Options

4 = None N/C
 5 = High/low alarm 1 point 35
 G = High/low alarm 2 points 35

Box D: Power Supply

V = Standard (100-240V AC, 50/60Hz) N/C
 B = 24V AC/DC (50/60Hz) \$ 35

Box B: Control Output 1

A = Relay contact output N/C
 C = SSR or SSC drive output N/C
 E = 4-20mA DC output¹ N/C
 G = Triac 1A, 250 VAC⁴ \$40

Accessories

PXR4 Loader Assembly	Program loader for PXR4	350
PXR4 Terminal Cover	Terminal block protective cover	15

Furnace Heat Pattern Control

Heat Pattern Control — Ramp/Soak Function

Digital input
Ramp/Soak command

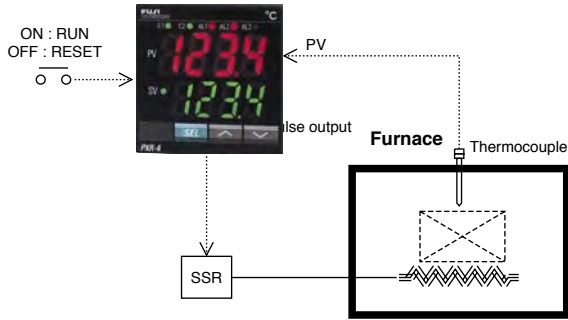

Ramp/Soak Function

- Control temperature according to "Heat pattern with ramp"
- Keep temperature stable for a certain period with "Heat pattern" and then cool down
- "Heat pattern" can be Started (RUN) /Reset by an external digital input.

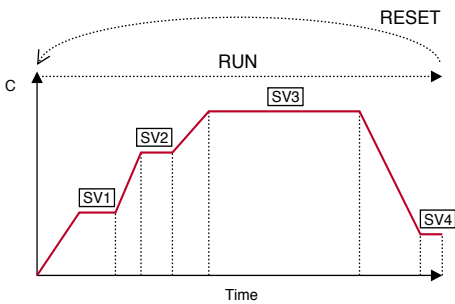

Plastic Molding Machine

Stable temperature control required — Fuzzy + PID Control

Digital input
Autotuning command

ON : Autotuning Start
OFF : Autotuning Strat

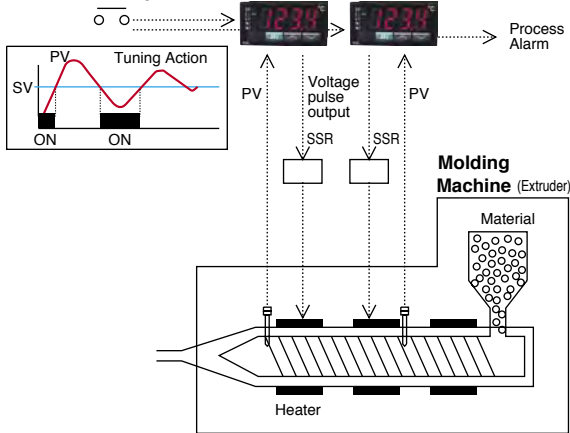

Auto-Tuning can be started/stopped through external digital input

Oven

To change SV easily

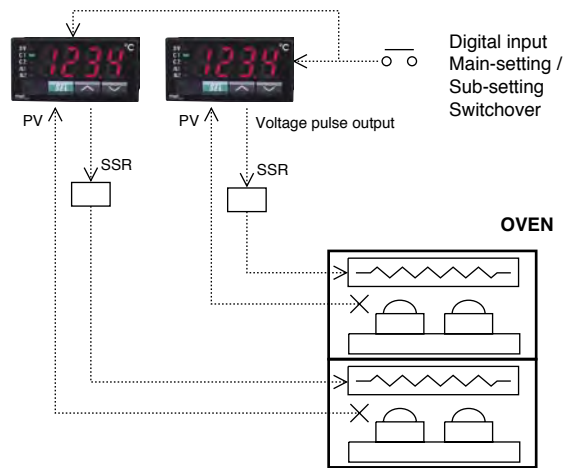

Set Value (SV) can be selected/changed externally.
<main SV, SV1~3 change over>

Fryer

To keep oil temperature stable

Digital input
Control : RUN / STAND-BY

OFF : RUN
ON : STAND-BY

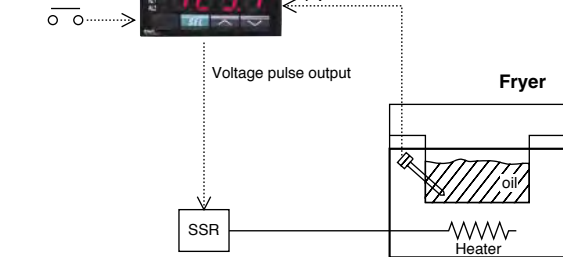

Control RUN/Stand-by selectable through external digital input

Cooling & Heating Control

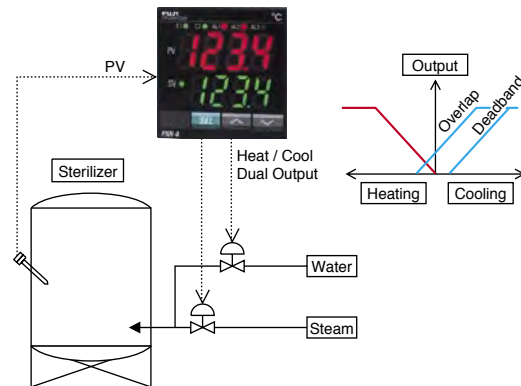

Cooling output and Heating output can be overlapped or a "Dead-band" set between them.