

NEEDLE

VALVES

Soft Seat

mini valve

NOSHOK Multiport Gauge
reduce the number of gaug
and other instrument conn
to permanent fitting install
therefore decreasing possi
leak points (paths)

multiport



at a maximum pressure rating
6000 psi for the Stainless Steel
and Steel models

Stem and bonnet threads are
rolled for greater strength and
smoother operation

valve is the
-horse of the industry

Hard Seat

A precision molded, replaceab
is the key to the bubble tight
the Soft Seat Valve.
Typically used in gaseous appl
this valve will provide years
trouble free service.

Brass

3000 psi

6000 psi

block & bleed

Stainless Steel

The
Instrumentation
Company

INCORPORATED



CompanyProfile

Established in 1967, NOSHOK was one of the first companies in America to offer liquid filled pressure gauges, a revolutionary concept at the time. More importantly, NOSHOK was the first company to stand behind its instrumentation products with extended warranties and we're still the leader today. The NOSHOK standard of quality and reliability continues to be the industry benchmark over 30 years later.

Today, NOSHOK pressure measurement instruments are sold through a network of over 270 distributors worldwide. Our continued commitment to product excellence, total service and our sincere desire to be the best provides the NOSHOK customer with a distinct edge.

Over the years we have expanded our program to meet the ever changing needs of our customers with additional pressure gauge products, pressure snubbers, diaphragm seals, bimetal thermometers, needle valves, solenoid valves, transducers, transmitters & digital indicators. And now with the latest expansion of our Needle Valve Offering.

The same high quality, superior performance and unsurpassed reliability that the industry has come to expect from other NOSHOK instrument products are now available in NOSHOK Needle Valves. Available in a multitude of materials, port configurations and seat types, NOSHOK Needle Valves are the right choice when positive shut off or precise flow control and metering of most gases and liquids is required.

Additionally, every NOSHOK Needle Valve is helium leak tested and fully checked for proper operation to insure 100% "out of the box" reliability.

NOSHOK also has the capability to provide you with the application assistance necessary to put together that special requirement which is often so hard to find. If it's not in our catalog, call us, we are confident we can satisfy your needs.

At NOSHOK, we proudly back our commitment to excellence with our warranties.
Thank You for choosing NOSHOK products.

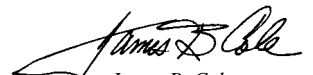

James B. Cole
Chief Executive Officer

Table of Contents

<i>Page</i>	
4-5	100Series <i>Mini Valves</i>
6-7	200&300Series <i>Multiport Valves</i>
8-9	400Series <i>Hard Seat Valves</i>
10-11	500Series <i>Soft Seat Valves</i>
12-13	600&700Series <i>Block & Bleed Valves</i>
14	Flow Characteristics

NOSHOK'S THREE YEAR WARRANTY

- to be free from defects in materials and workmanship
- to operate within catalogued performance specifications

The Needle Valves must be operated within the catalogued environmental and application parameters. Determination of failure will be made at NOSHOK using its equipment and personnel or a certified test facility specializing in this type of evaluation.

CAUTION

Operating conditions including but not limited to, system pressure, media compatibility and environmental conditions must be considered when selecting needle valves and options. Improper selection and use of needle valves could possibly cause failure and lead to possible property damage and/or personal injury.

DISCLAIMER

In keeping with and for the purposes of product and/or manufacturing process improvements, NOSHOK, Inc. reserves the right to make design and/or specification changes without prior notice.

NOSHOK is a member and actively supports:



100 SERIES mini VALVES



The **New NOSHOK 100 Series Mini Valve** is a big valve in a little package. Available in electroless nickel plated steel, electropolished stainless steel and brass, the **Mini Valve** was designed with your toughest applications in mind. All are equipped with both a Viton® O-Ring seal and a Teflon® back-up ring below the stem threads to protect the **Mini Valve** from corrosion and galling. The stem threads are rolled for strength and ease of operation, and the metal-to-metal hard seat design is *100% Helium leak tested* to 1×10^{-4} ml/s at 200 psi on each **Mini Valve**.

At a maximum pressure rating of 6000 psi for the Stainless Steel and Steel models and a 3000 psi rating for the Brass models, the **NOSHOK Mini Valve** has much to offer for such a little valve. With a variety of optional handles to choose from and the panel mount option, the **Mini Valve** will fit perfectly into any application.

Ordering Information

PART NUMBER	CONNECTION	MATERIAL
101 MMB	1/8 NPT Male-Male	Brass
102 MMB	1/4 NPT Male-Male	Brass
101 MMC	1/8 NPT Male-Male	Steel
102 MMC	1/4 NPT Male-Male	Steel
101 MMS	1/8 NPT Male-Male	Stainless Steel
102 MMS	1/4 NPT Male-Male	Stainless Steel
101 MFB	1/8 NPT Male-Female	Brass
102 MFB	1/4 NPT Male-Female	Brass
101 MFC	1/8 NPT Male-Female	Steel
102 MFC	1/4 NPT Male-Female	Steel
101 MFS	1/8 NPT Male-Female	Stainless Steel
102 MFS	1/4 NPT Male-Female	Stainless Steel
101 FFB	1/8 NPT Female-Female	Brass
102 FFB	1/4 NPT Female-Female	Brass
101 FFC	1/8 NPT Female-Female	Steel

PART NUMBER	CONNECTION	MATERIAL
102 FFC	1/4 NPT Female-Female	Steel
101 FFS	1/8 NPT Female-Female	Stainless Steel
102 FFS	1/4 NPT Female-Female	Stainless Steel
101 MFAB	1/8 NPT Male-Female Angle	Brass
102 MFAB	1/4 NPT Male-Female Angle	Brass
101 MFAC	1/8 NPT Male-Female Angle	Steel
102 MFAC	1/4 NPT Male-Female Angle	Steel
101 MFAS	1/8 NPT Male-Female Angle	Stainless Steel
102 MFAS	1/4 NPT Male-Female Angle	Stainless Steel
101 FFAB	1/8 NPT Female-Female Angle	Brass
102 FFAB	1/4 NPT Female-Female Angle	Brass
101 FFAC	1/8 NPT Female-Female Angle	Steel
102 FFAC	1/4 NPT Female-Female Angle	Steel
101 FFAS	1/8 NPT Female-Female Angle	Stainless Steel
102 FFAS	1/4 NPT Female-Female Angle	Stainless Steel

When ordering options please refer to the Part Number Construction guide below for the appropriate suffix. Please note that the standard O-Ring in all the **NOSHOK Mini Valves** are Viton® and the standard handles are:

Brass: Round Knurled (HL3) • **Steel:** Mini "T" (HL1) • **316SS:** Mini "T" (HL1)

The handle material will always match the material of the valve, unless otherwise specified. For example, the round knurled (HL3) on a 102 FFB will be brass. When only the standard configuration is needed, no additional designations are necessary. Please consult the factory for special application requests.

Part Number Construction: **102 FFC - PM2 - EM1 - HL4**

Panel Mount Options	O-Ring Options	Handle Options
PM1 - Panel Mount (1 nut) PM2 - Panel Mount (2 nuts)	EM1 - EPDM 80 KZ1 - Kalrez® 3018	HL1 - Mini "T" HL2 - "T" HL3 - Round Knurled HL4 - 1-3/8 Phenolic HL5 - 1-3/4 Phenolic

General Dimensions

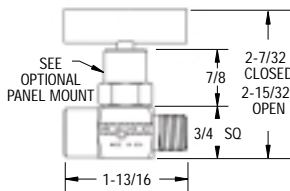

Male-Female w/"T" handle option

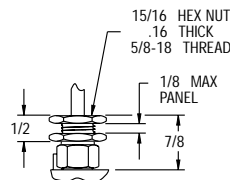

PANEL MOUNT DETAIL

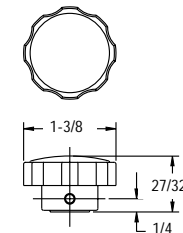

PHENOLIC HANDLE HL4

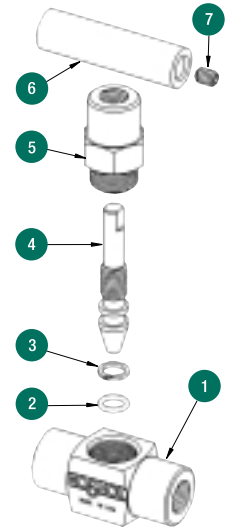
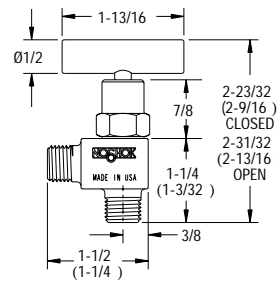
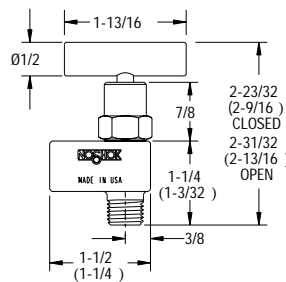
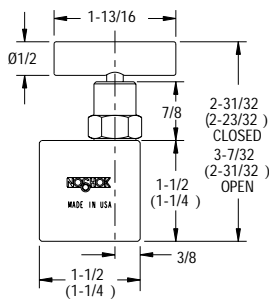

- 1 Mini Valve Body
- 2 Viton® O-Ring
- 3 Teflon® Back-up Ring
- 4 Mini Valve Stem
- 5 Mini Valve Bonnet
- 6 Mini Valve "T" Handle
- 7 Set Screw

For flow characteristics refer to page 14

Kalrez® and Viton® are registered trademarks of DuPont Dow Elastomers
Teflon® is a registered trademark of the DuPont Company

Technical Data:

Maximum Pressure Rating:	Orifice size:	0.172"
Steel: 6000 psi	Flow Coefficient:	0.42
Stainless Steel: 6000 psi	Standard O-Ring:	Viton®
Brass: 3000 psi	Standard Back-up Ring:	Teflon®

200&300 SERIES

multiport VALVES

HARD & SOFT SEAT



NOSHOK Multiport Gauge Valves reduce the number of gauge and other instrument connections to permanent piping installations, therefore decreasing possible leak points (paths). Optional bleed plugs further allow pressure to be bled off without disturbing the permanent piping installation.

HARD SEAT VALVE FEATURES

- Metal to metal hard seat design is 100% Helium leak tested to 1×10^{-4} ml/s at 200 psi.
- 10000 psi pressure rating (@ 200°F maximum)

SOFT SEAT VALVE FEATURES

- Soft seat design is 100% Helium leak tested to 1×10^{-4} ml/s at 200 psi.
- 6000 psi pressure rating (@ 200°F maximum)
- Replaceable Delrin seat.
- Straight through porting for bi-directional, high capacity flow and easy roddable cleaning.

STANDARD FEATURES FOR HARD SEAT and SOFT SEAT VALVES

- Blow-out proof stem that provides a secondary stem seal in the full open position.
- Stem packing below the threads prevents thread galling and contamination.
- Viton® O-Ring & Teflon® back-up ring stem seals.
- All 316SS stems (even in steel valves) for longer life.
- Stem and bonnet threads are rolled for greater strength and smoother operation.
- One piece bonnet with a metal to metal seal to the valve body below the bonnet threads.
- Bonnet lock pin to prevent accidental loosening.
- Vinyl bonnet and stem dust cap.
- .187 inch orifice size.
- Optional panel mount bonnet and panel nuts.
- Electroless Nickel plated finish on carbon steel valves.
- Electropolish finish on stainless steel valves.

Ordering Information

200 SERIES - HARD SEAT MULTIPORT VALVES		
PART NUMBER	CONNECTION	MATERIAL
204 MFC	1/2 NPT Male-Female	Steel
20604 MFC	3/4 NPT Male- 1/2 NPT Female	Steel
204 MFS	1/2 NPT Male-Female	Stainless Steel
20604 MFS	3/4 NPT Male- 1/2 NPT Female	Stainless Steel

300 SERIES - SOFT SEAT MULTIPORT VALVES		
PART NUMBER	CONNECTION	MATERIAL
304 MFC	1/2 NPT Male-Female	Steel
30604 MFC	3/4 NPT Male- 1/2 NPT Female	Steel
304 MFS	1/2 NPT Male-Female	Stainless Steel
30604 MFS	3/4 NPT Male- 1/2 NPT Female	Stainless Steel

NACE MRO175-99 CERTIFICATION (Consult Factory)

When ordering options please refer to the Part Number Construction guide below for the appropriate suffix. Please note that the standard O-Ring in all the **NOSHOK** Valves are Viton® and the standard handles are: "T" handles.

Part Number Construction: **304 MFC - PG - PM2 - EM1 - HL5**

PG - 200/300 Series Plug, Steel
PG - 200/300 Series Plug, SS
BP - 200/300 Series Bleed Plug, Steel
BP - 200/300 Series Bleed Plug, SS
All Plugs can also be ordered separately

Panel Mount Options
PM1 - Panel Mount (1 nut)
PM2 - Panel Mount (2 nuts)

O-Ring Options
EM1 - EPDM 80
KZ1 - Kalrez® 3018

Handle Options
HL1 - Mini "T"
HL2 - "T"
HL3 - Round Knurled
HL4 - 1-3/8 Phenolic
HL5 - 1-3/4 Phenolic

General Dimensions

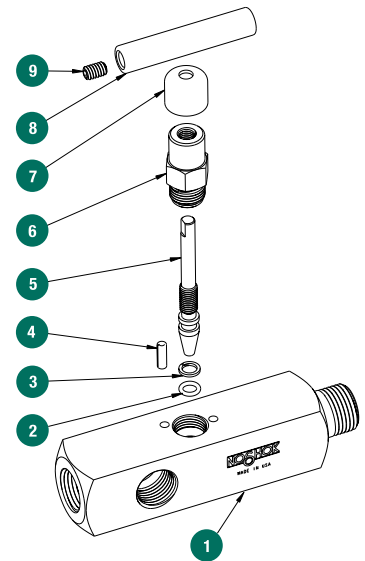
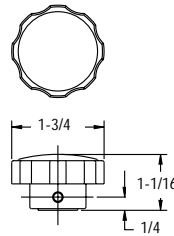
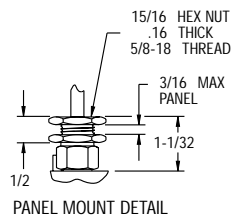
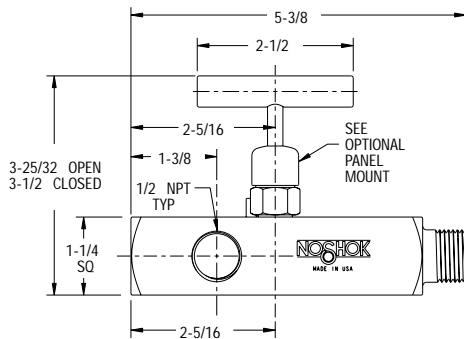

- 1 Valve Body
- 2 Viton® O-Ring
- 3 Teflon® Back-up Rings
- 4 Bonnet Lock Pin
- 5 Valve Stem
- 6 Valve Bonnet
- 7 Dust Cap
- 8 Valve Handle
- 9 Set Screw

Hard Seat Technical Data:

Maximum Pressure Rating: Orifice size: 0.187"
Steel: 10000 psi **Flow Coefficient:** 0.44
Stainless Steel: 10000 psi **Standard O-Ring:** Viton®
Standard Back-up Ring: Teflon®

Soft Seat Technical Data:

Maximum Pressure Rating: Orifice size: 0.187"
Steel: 6000 psi **Flow Coefficient:** 0.64
Stainless Steel: 6000 psi **Standard O-Ring:** Viton®
Standard Back-up Ring: Teflon®

For flow characteristics refer to page 14

Kalrez® and Viton® are registered trademarks of DuPont Dow Elastomers
Teflon® is a registered trademark of the DuPont Company

400 SERIES hard seat VALVES



***THIS VALVE IS THE WORK-HORSE OF THE INDUSTRY...
and is fast becoming the standard that other hard seat needle valves are judged against.***

- Metal to metal hard seat design is *100% Helium leak tested* to 1×10^{-4} ml/s.
- 10,000 psi pressure rating (@200°F maximum).
- Blow out proof stem that provides a secondary stem seal in the full open position.
- Stem packing below the threads prevents thread galling & corrosion.
- Viton O-Ring & Teflon back-up ring stem seals.
- All 316SS stems (even in steel valves) for longer life.
- Stem and bonnet threads are rolled for greater strength and smoother operation.
- Angled stem for precise flow metering.
- One piece bonnet with a metal to metal seal to the valve body below the bonnet threads.
- Bonnet lock pin to prevent accidental loosening.
- Vinyl bonnet & stem dust cap.
- Optional panel mount bonnet and panel nuts.
- Electroless Nickel plated finish on carbon steel valves.
- Electropolish finish on stainless steel valves.

Ordering Information

PART NUMBER	CONNECTION	MATERIAL
402 MFC	1/4 NPT Male-Female	Steel
404 MFC	1/2 NPT Male-Female	Steel
406 MFC	3/4 NPT Male-Female	Steel
408 MFC	1 NPT Male-Female	Steel
410 MFC	1-1/4 NPT Male-Female	Steel
412 MFC	1-1/2 NPT Male-Female	Steel
402 MFS	1/4 NPT Male-Female	Stainless Steel
404 MFS	1/2 NPT Male-Female	Stainless Steel
406 MFS	3/4 NPT Male-Female	Stainless Steel
408 MFS	1 NPT Male-Female	Stainless Steel
410 MFS	1-1/4 NPT Male-Female	Stainless Steel
412 MFS	1-1/2 NPT Male-Female	Stainless Steel
402 FFC	1/4 NPT Female-Female	Steel
403 FFC	3/8 NPT Female-Female	Steel
404 FFC	1/2 NPT Female-Female	Steel
406 FFC	3/4 NPT Female-Female	Steel
408 FFC	1 NPT Female-Female	Steel
410 FFC	1-1/4 NPT Female-Female	Steel

PART NUMBER	CONNECTION	MATERIAL
412 FFC	1-1/2 NPT Female-Female	Steel
442 FFC	*7/16 -20 UNF-2B Female-Female	Steel
402 FFS	1/4 NPT Female-Female	Stainless Steel
403 FFS	3/8 NPT Female-Female	Stainless Steel
404 FFS	1/2 NPT Female-Female	Stainless Steel
406 FFS	3/4 NPT Female-Female	Stainless Steel
408 FFS	1 NPT Female-Female	Stainless Steel
410 FFS	1-1/4 NPT Female-Female	Stainless Steel
412 FFS	1-1/2 NPT Female-Female	Stainless Steel
442 FFS	*7/16 -20 UNF-2B Female-Female	Stainless Steel
402 MFAC	1/4 NPT Female-Female Angle	Steel
404 MFAC	1/2 NPT Male-Female Angle	Steel
402 MFAS	1/4 NPT Male-Female Angle	Stainless Steel
404 MFAS	1/2 NPT Male-Female Angle	Stainless Steel
402 FFAC	1/4 NPT Female-Female Angle	Steel
404 FFAC	1/2 NPT Female-Female Angle	Steel
402 FFAS	1/4 NPT Female-Female Angle	Stainless Steel
404 FFAS	1/2 NPT Female-Female Angle	Stainless Steel

When ordering options please refer to the Part Number Construction guide below for the appropriate suffix. Please note that the standard O-Ring in all the **NOSHOK** Valves are Viton® and the standard handles are: "T" handles. * SAE J1926-4 O-Ring Port.

Part Number Construction: 404 FFC - PM2 - EM1 - HL5

Panel Mount Options

PM1 - Panel Mount (1 nut)
PM2 - Panel Mount (2 nuts)

O-Ring Options

EM1 - EPDM 80
KZ1 - Kalrez® 3018

Handle Options

HL1 - Mini "T"
HL2 - "T"
HL3 - Round Knurled
HL4 - 1-3/8 Phenolic
HL5 - 1-3/4 Phenolic

General Dimensions

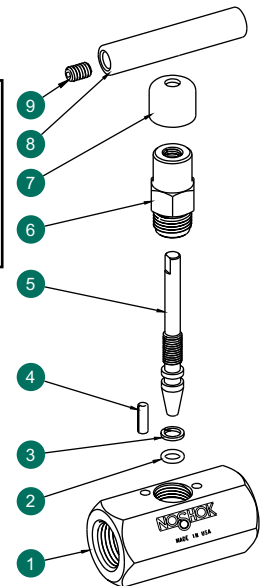
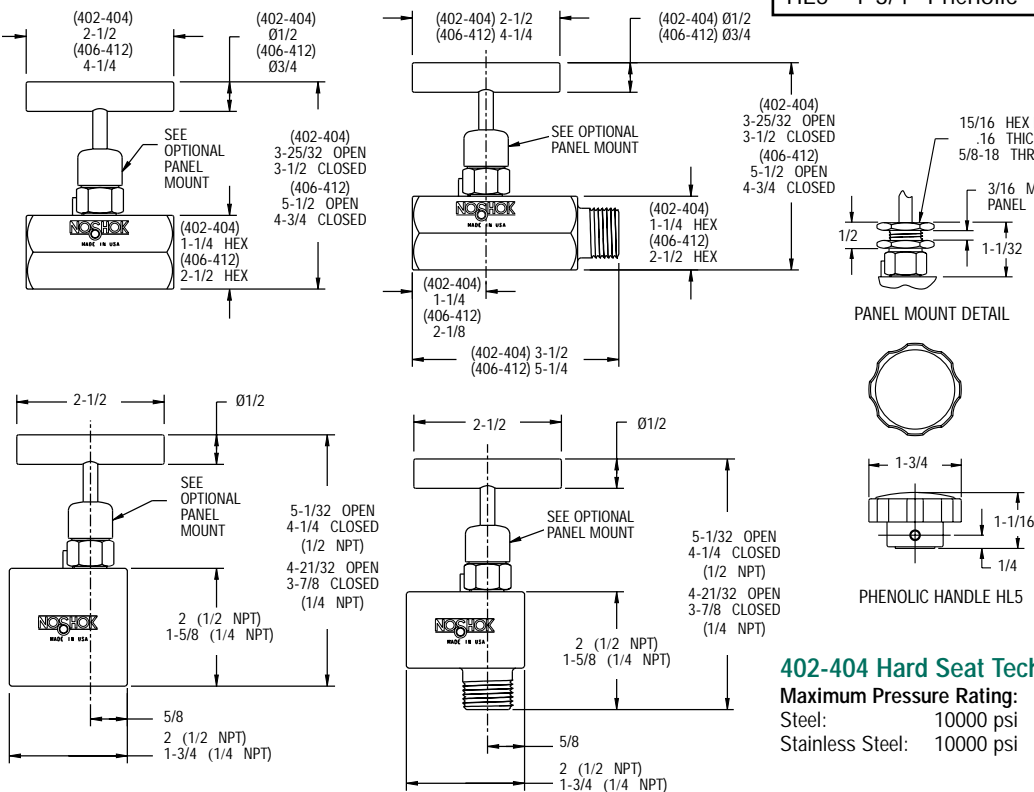

- 1 Valve Body
- 2 Viton® O-Ring
- 3 Teflon® Back-up Rings
- 4 Bonnet Lock Pin
- 5 Valve Stem
- 6 Valve Bonnet
- 7 Dust Cap
- 8 Valve Handle
- 9 Set Screw

402-404 Hard Seat Technical Data:

Maximum Pressure Rating:	Orifice size:	0.187"
Steel: 10000 psi	Flow Coefficient:	0.44
Stainless Steel: 10000 psi	Standard O-Ring:	Viton®
	Standard Back-up Ring:	Teflon®

406-412 Hard Seat Technical Data:

Maximum Pressure Rating:	Orifice size:	0.438"
Steel: 10000 psi	Flow Coefficient:	2.70
Stainless Steel: 10000 psi	Standard O-Ring:	Viton®
	Standard Back-up Ring:	Teflon®

For flow characteristics refer to page 14

Kalrez® and Viton® are registered trademarks of DuPont Dow Elastomers
Teflon® is a registered trademark of the DuPont Company

500 SERIES soft seat VALVES



A precision molded, replaceable delrin soft seat is the key to the bubble tight seal of the Soft Seat Valve. Typically used in gaseous application, this valve will provide years of dependable, trouble free service.

- Soft seat design is 100% Helium leak tested to 1×10^{-4} ml/s.
- 6,000 psi pressure rating (@200°F maximum).
- Replaceable Delrin seat.
- Straight through porting for bi-directional, high capacity flow and easy roddable cleaning.
- Blow out proof stem that provides a secondary stem seal in the full open position.
- Stem packing below the threads prevents thread galling & contamination.
- Viton O-Ring & Teflon back-up ring stem seals.
- All 316SS stems (even in steel valves) for longer life.
- Stem and bonnet threads are rolled for greater strength and smoother operation.
- One piece bonnet with a metal to metal seal to the valve body below the bonnet threads.
- Bonnet lock pin to prevent accidental loosening.
- Vinyl bonnet & stem dust cap.
- .187 inch orifice size.
- Optional panel mount bonnet and panel nuts.
- Electroless Nickel plated finish on carbon steel valves.
- Electropolish finish on stainless steel valves.

Ordering Information

PART NUMBER	CONNECTION	MATERIAL
502 MFC	1/4 NPT Male-Female	Steel
504 MFC	1/2 NPT Male-Female	Steel
50402 MFC	1/2 NPT Male-1/4 NPT Female	Steel
502 MFS	1/4 NPT Male-Female	Stainless Steel
504 MFS	1/2 NPT Male-Female	Stainless Steel
502 FFC	1/4 NPT Female-Female	Steel
503 FFC	3/8 NPT Female-Female	Steel
504 FFC	1/2 NPT Female-Female	Steel
502 FFS	1/4 NPT Female-Female	Stainless Steel
503 FFS	3/8 NPT Female-Female	Stainless Steel
504 FFS	1/2 NPT Female-Female	Stainless Steel

When ordering options please refer to the Part Number Construction guide below for the appropriate suffix. Please note that the standard O-Ring in all the **NOSHOK** Valves are Viton® and the standard handles are: "T" handles.

Part Number Construction: **504 FFC - PM2 - KZ1 - HL5**

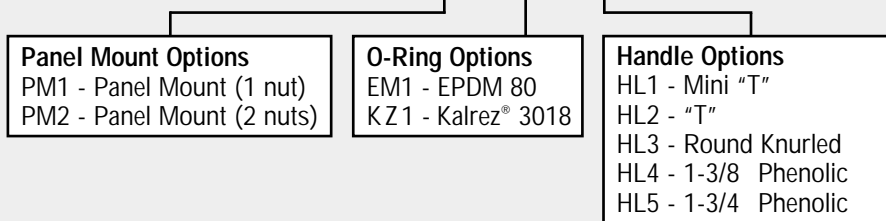

General Dimensions

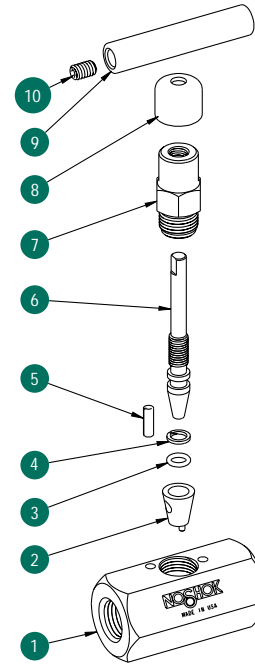
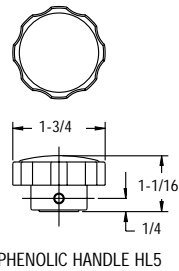
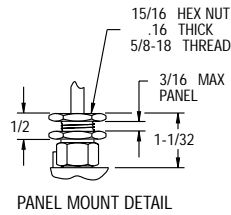
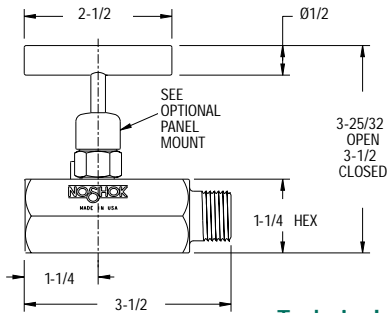
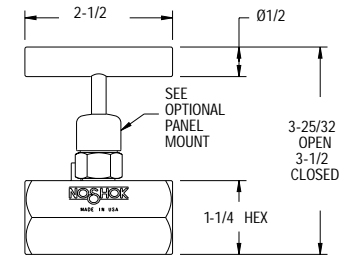

Technical Data:

Maximum Pressure Rating:	Orifice size:	0.187"
Steel: 6000 psi	Flow Coefficient:	0.76
Stainless Steel: 6000 psi	Standard O-Ring:	Viton®
	Standard Back-up Ring:	Teflon®

- 1 Valve Body
- 2 Delrin Seat
- 3 Viton® O-Ring
- 4 Teflon® Back-up Ring
- 5 Bonnet Lock Pin
- 6 Valve Stem
- 7 Valve Bonnet
- 8 Dust Cap
- 9 Valve "T" Handle
- 10 Handle Set Screw

For flow characteristics refer to page 14

Kalrez® and Viton® are registered trademarks of DuPont Dow Elastomers
Teflon® is a registered trademark of the DuPont Company

600&700 SERIES

block & bleed VALVES

HARD & SOFT SEAT



NOSHOK Block & Bleed Valves allow pressure to be bled off without disturbing the permanent piping installation thereby enabling the user to quickly and easily remove and/or replace instruments.

HARD SEAT VALVE FEATURES

- Metal to metal hard seat design is 100% Helium leak tested to 1×10^{-4} ml/s at 200 psi.
- 10,000 psi pressure rating (@ 200°F maximum)

SOFT SEAT VALVE FEATURES

- Soft seat design is 100% Helium leak tested to 1×10^{-4} ml/s at 200 psi.
- 6,000 psi pressure rating (@ 200°F maximum)
- Replaceable Delrin seat.
- Straight through porting for bi-directional, high capacity flow and easy roddable cleaning.

STANDARD FEATURES FOR HARD SEAT and SOFT SEAT VALVES

- Blow-out proof stem that provides a secondary stem seal in the full open position.
- Stem packing below the threads prevents thread galling and contamination.
- Viton® O-Ring & Teflon® back-up ring stem seals.
- All 316SS stems (even in steel valves) for longer life.
- Stem and bonnet threads are rolled for greater strength and smoother operation.
- One piece bonnet with a metal to metal seal to the valve body below the bonnet threads.
- Bonnet lock pin to prevent accidental loosening.
- Vinyl bonnet and stem dust cap.
- .187 inch orifice size.
- Optional panel mount bonnet and panel nuts.
- Electroless Nickel plated finish on carbon steel valves.
- Electropolish finish on stainless steel valves.

Ordering Information

600 SERIES - HARD SEAT BLOCK & BLEED VALVES

PART NUMBER	CONNECTION	MATERIAL
602 MFC	1/4 NPT Male-Female	Steel
604 MFC	1/2 NPT Male-Female	Steel
602 MFS	1/4 NPT Male-Female	Stainless Steel
604 MFS	1/2 NPT Male-Female	Stainless Steel
602 FFC	1/4 NPT Female-Female	Steel
604 FFC	1/2 NPT Female-Female	Steel
602 FFS	1/4 NPT Female-Female	Stainless Steel
604 FFS	1/2 NPT Female-Female	Stainless Steel

700 SERIES - SOFT SEAT BLOCK & BLEED VALVES

PART NUMBER	CONNECTION	MATERIAL
702 MFC	1/4 NPT Male-Female	Steel
704 MFC	1/2 NPT Male-Female	Steel
702 MFS	1/4 NPT Male-Female	Stainless Steel
704 MFS	1/2 NPT Male-Female	Stainless Steel
702 FFC	1/4 NPT Female-Female	Steel
704 FFC	1/2 NPT Female-Female	Steel
702 FFS	1/4 NPT Female-Female	Stainless Steel
704 FFS	1/2 NPT Female-Female	Stainless Steel

NACE MRO175-99 CERTIFICATION (Consult Factory)

When ordering options please refer to the Part Number Construction guide below for the appropriate suffix. Please note that the standard O-Ring in all the **NOSHOK** Valves are Viton® and the standard handles are: "T" handles.

Part Number Construction: **702 FFC - PM2 - EM1 - HL5**

Panel Mount Options

PM1 - Panel Mount (1 nut)
PM2 - Panel Mount (2 nuts)

O-Ring Options

EM1 - EPDM 80
KZ1 - Kalrez® 3018

Handle Options

HL1 - Mini "T"
HL2 - "T"
HL3 - Round Knurled
HL4 - 1-3/8 Phenolic
HL5 - 1-3/4 Phenolic

General Dimensions

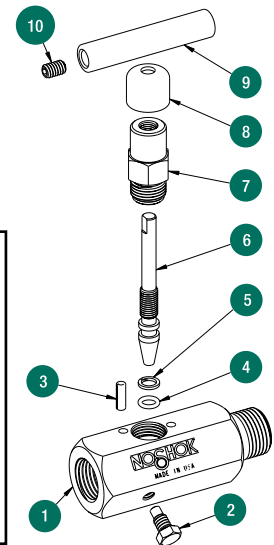
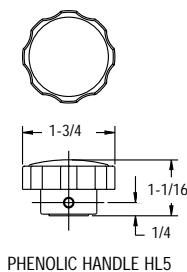
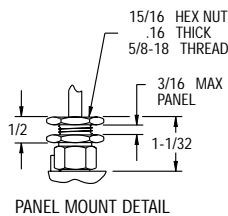
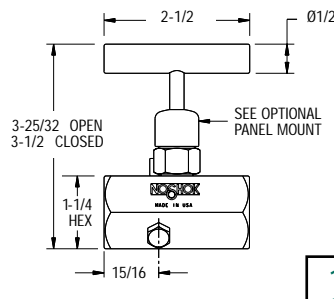
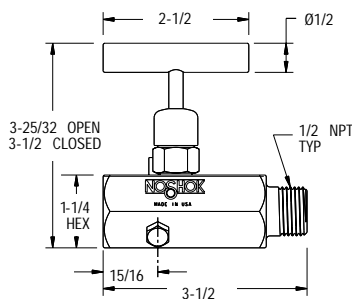

- 1 Valve Body
- 2 Bleed Screw
- 3 Bonnet Lock Pin
- 4 Viton® O-Ring
- 5 Teflon® Back-up Ring
- 6 Valve Stem
- 7 Valve Bonnet
- 8 Dust Cap
- 9 Valve "T" Handle
- 10 Handle Set Screw

Hard Seat Technical Data:

Maximum Pressure Rating: Orifice size: 0.187"
 Steel: 10000 psi Flow Coefficient: 0.44
 Stainless Steel: 10000 psi Standard O-Ring: Viton®
 Standard Back-up Ring: Teflon®

Soft Seat Technical Data:

Maximum Pressure Rating: Orifice size: 0.187"
 Steel: 6000 psi Flow Coefficient: 0.76
 Stainless Steel: 6000 psi Standard O-Ring: Viton®
 Standard Back-up Ring: Teflon®

For flow characteristics refer to page 14

Kalrez® and Viton® are registered trademarks of DuPont Dow Elastomers
 Teflon® is a registered trademark of the DuPont Company

FLOW CHARACTERISTICS

