

BETAGAUGE 311A/321A

Reference Manual



**BETAGauge 311A/321A
Reference Manual**

1. Introduction	.1
1.1 Contacting Martel / Beta	.1
1.2 Standard Equipment	.1
1.3 Safety Information	.1
2. Calibrator Interface	.3
2.1 Calibrator Display	.5
2.2 Using the Backlight	.9
2.3 Using the Zero Function	.9
2.4 Other Menu Controlled Functions	.10
3. Measuring Pressure	.13
3.1 Media Compatibility	.14
3.2 Measuring Pressure with External Modules	.14
4. Measuring Current	.15
5. Measuring Voltage	.16
6. Measuring Temperature with an RTD	.16
7. Performing a Pressure Switch Test	.17
8. Calibrating Transmitters	.19
8.1 Using the mA Input Function	.19
8.2 Calibrating a Pressure-to-Current Transmitter	.20
8.3 Percent Error Function	.21
9. Minimum and Maximum Storage Capability	.23
10. Factory Setups	.24
11. Custody Transfer / Flow Calibration	.25
12. Remote Operation	.26
12.1 Remote Interface	.26
12.2 Setting up the RS-232 Port for Remote Control	.26
12.3 Changing Between Remote and Local Operation	.27
12.4 Using Commands	.27
12.5 Remote Commands and Error Codes	.29
12.6 Entering Commands	.32
13. Specifications	.39
14. Warranty	.41
15. Maintenance	.41
15.1 Replacing Batteries	.41
15.2 Cleaning the Unit	.41
15.3 Service Center Calibration or Repair	.41

1. Introduction

The Beta 311A/321A is designed to be a simple to use yet very versatile pressure calibrator. Its two internal pressure sensors combined with inputs for mA, voltage, switch contacts and an RTD probe allow the 311A/321A to calibrate virtually any pressure device. An external pressure module option allows an even wider range of pressure calibration options including absolute and differential.

The BetaGauge 311A is a single sensor pressure calibrator; the BetaGauge 321A is a dual sensor pressure calibrator. The 311A uses the P1 port for all pressure inputs. The P2 port is only used on the model 321A. Therefore on the model 311A, all menu choices involving pressure are limited to the P1 port only. All other model 311A features and functions are the same as for the 321A.

1.1 Customer Service

Corporate Office:

www.martelcorp.com

e-mail: sales@martelcorp.com

Tel: (603) 434-1433 800-821-0023 Fax: (603) 434-1653

Martel Electronics

3 Corporate Park Dr.

Derry, NH 03038

1.2 Standard Equipment









Check to see if your calibrator is complete. It should include: Beta 311A/321A Calibrator, instruction manual, test leads, carrying case, calibration certificate with data.

1.3 Safety information

Symbols Used

The following table lists the International Electrical Symbols. Some or all of these symbols may be used on the instrument or in this manual.

Symbol	Description
	AC (Alternating Current)
	AC-DC
	Battery
	CE Complies with European Union Directives
	DC
	Double Insulated

Symbol	Description
	Electric Shock
	Fuse
	PE Ground
	Hot Surface (Burn Hazard)
	Read the User's Manual (Important Information)
	Off
	On
	Canadian Standards Association

The following definitions apply to the terms “Warning” and “Caution”.

- “Warning” identifies conditions and actions that may pose hazards to the user.
- “Caution” identifies conditions and actions that may damage the instrument being used.

Use the calibrator only as specified in this manual, otherwise injury and damage to the calibrator may occur.

 **Warning**

To avoid possible electric shock or personal injury:

- Do not apply more than the rated voltage. See specifications for supported ranges.
- Follow all equipment safety procedures.
- Never touch the probe to a voltage source when the test leads are plugged into the current terminals.
- Do not use the calibrator if it is damaged. Before you use the calibrator, inspect the case. Look for cracks or missing plastic. Pay particular attention to the insulation surrounding the connectors.
- Select the proper function and range for your measurement.
- Make sure the battery cover is closed and latched before you operate the calibrator.
- Remove test leads from the calibrator before you open the battery door.
- Inspect the test leads for damaged insulation or exposed metal. Check test leads continuity. Replace damaged test leads before you use the calibrator.
- When using the probes, keep your fingers away from the probe contacts. Keep your fingers behind the finger guards on the probes.

- Connect the common test lead before you connect the live test lead. When you disconnect test leads, disconnect the live test lead first.
- Do not use the calibrator if it operates abnormally. Protection may be impaired. When in doubt, have the calibrator serviced.
- Do not operate the calibrator around explosive gas, vapor, or dust.
- When measuring pressure, make sure the process pressure line is shut off and depressurized before you connect it or disconnect it from the pressure module.
- Disconnect test leads before changing to another measure or source function.
- When servicing the calibrator, use only specified replacement parts.
- To avoid false readings, which could lead to possible electric shock or personal injury, replace the battery as soon as the battery indicator appears.

Caution

To avoid possible damage to calibrator or to equipment under test:

- Use the proper jacks, function, and range for your measurement or sourcing application.

2. Calibrator Interface

Figure 1 shows the location of the process measurement inputs, while table 1 describes their use.

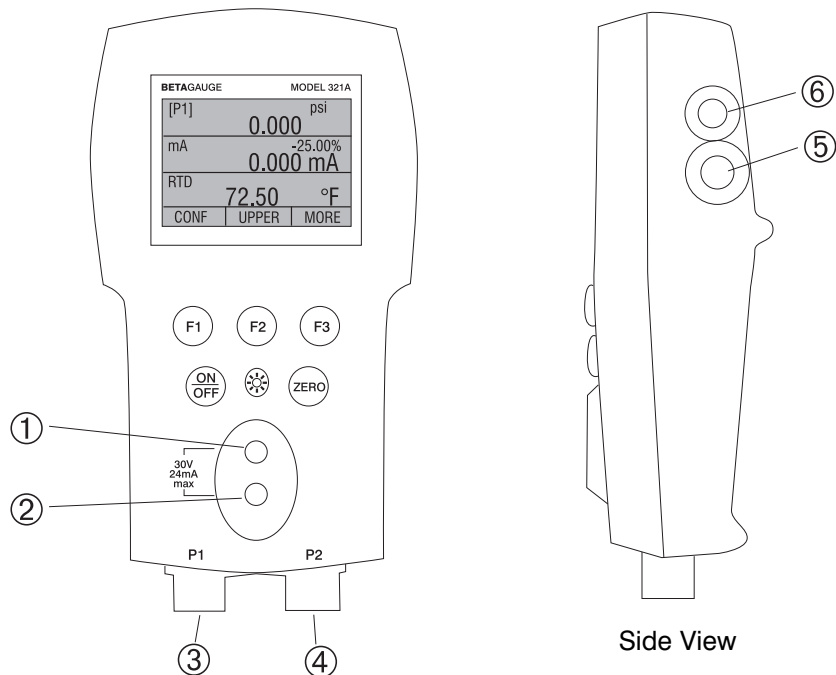
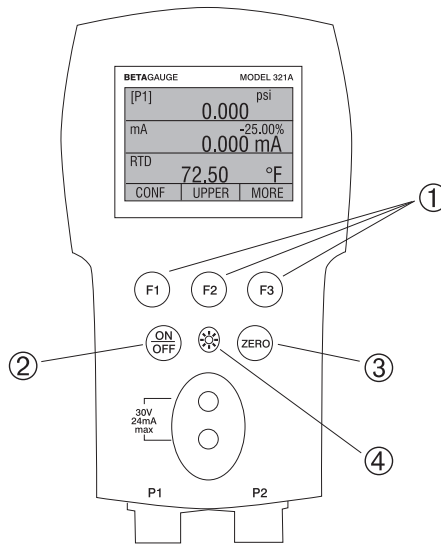

Figure 1
Pressure Measurement Inputs

Table 1 Process Measurement Inputs

No.	Name	Description
1, 2	Input Terminals	These terminal are used to measure current, voltage and a contact closure for switch test.
3	P1 Pressure Port	This is the connection for the internal sensor P1
4	P2 Pressure Port	This is the connection for the internal sensor P2
5	RTD Probe Connector	This connector is where the RTD probe is plugged in.
6	Serial Interface	This is used to interface to optional external modules as well as for RS-232 serial communications with a PC using the LEM-232 cable(optional).

Figure 2 shows the location of the keys. Table 2 describes the function of each key.



**Figure 2
Keypad**

Table 2 Key Functions

No.	Name	Description
1	Function Keys	These keys are used in various ways, primarily to configure the calibrator
2	ON/OFF Key	This key is used to turn the calibrator on and off
3	ZERO Key	This key is used to zero pressure measurements
4	Backlight Key	This key is used to turn the backlight on and off

Note: When the calibrator is turned on by pressing the ON/OFF key, it will go through a short startup self-check routine. During that routine, the display shows the current firmware revision level, auto shutdown status and the ranges of the 2 internal pressure sensors. The calibrator requires a maximum of 5 minutes warm-up to rated accuracy. Large changes in ambient temperature may require a longer warm-up period. See section 2.3 for instructions on zeroing the pressure sensor displays. Pressure ranges should be zeroed each time the calibrator is started.

2.1 Calibrator Display

The Calibrator Display consists of two regions: The menu bar (located along the bottom of the screen) is used to access a menu system. The main display (the rest) consists of up to three process measurement sub-regions. These sub-regions will henceforth be referred to as the UPPER, MIDDLE and LOWER displays. Figure 3 shows the location of the different display fields while table 3 describes them.

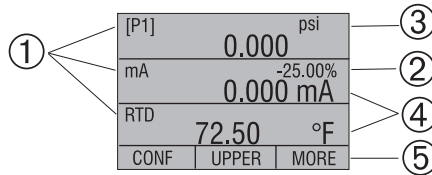

**Figure 3
Display**

Table 3 Display Functions

No.	Name	Description
1	Primary Parameters	Indicates what is being measured.
2	Span Indicator	Indicates the percent of the 4 to 20 mA span. (For mA and mA Loop functions only)
3	Pressure Units	Indicates one of 17 pressure units available for display.
4	Units	Indicates the unit of measure for the display.

2.1.1 Main Menu Functionality

There are three options on the Main Menu, CONFIG, {current display} and MORE. The Main Menu is home for the menu display.



2.1.1.1 Setting the Current Display

The current display is indicated by the center option on the Main Menu, pressing the F2 key will toggle the current display.

2.1.1.2 Setting Current Display Parameters

To set the parameters of the current display use the CONFIG option to get to the Display Configuration Menu.



Here the SELECT option will toggle through the choices for each parameter. The first parameter is MODE. Since voltage, current and switch test modes all use the same jacks, two of these functions cannot be used concurrently. The ability to select certain functions is limited based on what is already selected in another active display. The NEXT option is used to change to the second parameter. Only RTD and Pressure modes have a second parameter, RTDs can be read in Celsius or Fahrenheit and Pressures can be read in 11 engineering units.

With a single display the following modes are available:

P[1] = Pressure on left side sensor.

P[2] = Pressure on right side sensor.

[EXT] = Pressure with external pressure module.

P[1] ST = Switch Test with left side sensor.

P[2] ST = Switch Test with right side sensor.

[EXT] ST = Switch Test with external pressure module.

mA = Milliamps measure without loop power.

mA LOOP = Milliamps measure with loop power.

VOLTS = Voltage Measure.

RTD = RTD Temperature Measurement (if a probe is connected).

The following table shows which functions are available concurrently.

An X in a column indicates that the mode in the current display will not be available for selection if the mode in that row is in use in any other active display.

Table 4 Mode Concurrency

		CURRENT DISPLAY									
		P[1]	P[2]	[EXT]	P[1] ST	P[2] ST	[EXT] ST	mA	mA Loop	Volts	RTD
OTHER DISPLAYS	P[1]										
	P[2]										
	[EXT]										
	P[1]ST				X	X	X	X	X	X	
	P[2]ST				X	X	X	X	X	X	
	[EXT]ST				X	X	X	X	X	X	
	mA				X	X	X		X	X	
	mA Loop				X	X	X	X		X	
	Volts				X	X	X	X	X		
	RTD										

Note: P2 is only available on the model 321A.

2.1.1.3 Accessing Other Menus

Use the MORE option on the Main Menu to access the other menu functions.

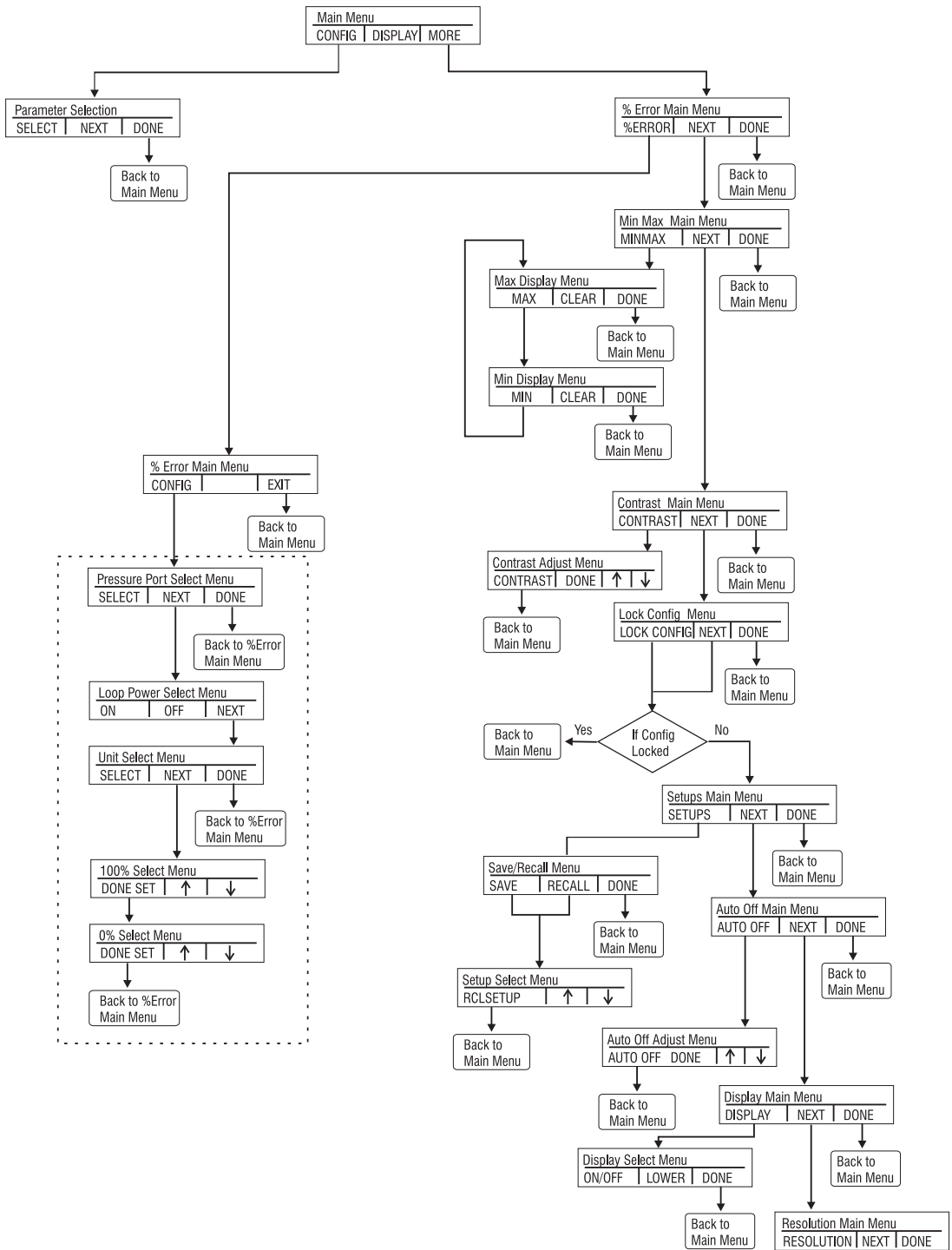

Continued on next page...

Figure 4
Menu Map

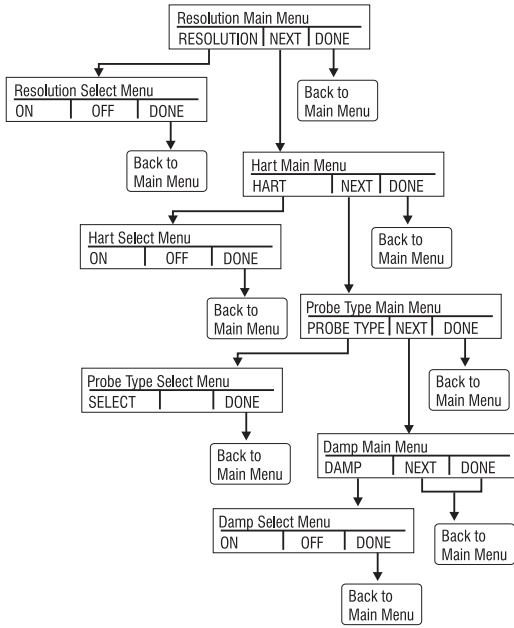

2.2 Using the Backlight

The backlight is controlled by the dedicated backlight key. It toggles on and off when the key is pressed; this is one of the few functions that cannot be controlled by the serial interface. There are no user configuration settings for the backlight.

2.3 Using the Zero Function

When the ZERO KEY is pressed, the calibrator will zero the current display if a pressure mode is selected, and the pressure is within the zero limit. The zero limits are within 5% of the full scale range of the selected sensor. If the display indicates “OL,” the zero function will not operate.”

2.3.1 Internal Sensor and Pressure Module (non-absolute)

When a sensor or module is selected on the current display and the ZERO KEY is pressed the calibrator subtracts the current reading from the output. The zero limits are within 5% of the full scale range of the selected sensor. If the display indicates “OL,” the zero function will not operate.

2.3.2 Absolute Internal Sensor or Absolute Pressure Module

When an absolute module is selected on the current display and the ZERO KEY is pressed, the calibrator prompts the user to either set or default the pressure reference.

PRESSURE REFERENCE		
14.612		
DEFAULT	SET	DONE

If the set option is selected, the calibrator prompts the user to enter the barometric reference pressure. This is done using the arrow keys (F2 and F3 keys). The sensor port should be open (vented) to atmosphere while performing this procedure.

PRESSURE REFERENCE		
14.612		
SET REF DONE	↑	↓

Alternately, if the DEFAULT option is selected, the user is asked to confirm the choice to go to factory default or cancel the request.

PRESSURE REFERENCE	

CONFIRM	CANCEL

2.4 Other Menu Controlled Functions

There are eight 'sub-main' menus that can be accessed through the MORE option of the Main Menu. A 'sub-main' menu contains three options. The first option is unique to the function. The second and third options of a 'sub-main' menu are always the same. The NEXT option leads to the next 'sub-main' menu and the DONE option returns home. For the last 'sub-main' menu the NEXT option wraps around to home. See Figure 4 for a detailed mapping of the menu structure.

A note on naming convention:

If a 'sub-main' menu has subordinate menus, it will henceforth be referred to as {function} Main Menu. E.g. the display contrast sub-main menu will be called the Contrast Main Menu. If not it will be called the {function} menu.

2.4.1 Setting the Contrast

From the Contrast Main Menu choose the CONTRAST option to access the Contrast Adjustment Menu.



Use the arrow keys to adjust the display contrast to the desired level and then use the CONTRAST DONE option to return home.



2.4.2 Locking and Unlocking Configurations

Use the LOCK CFG or UNLOCK CFG option of the Configuration Lock Menu to lock or unlock the display configuration.



When the LOCK CFG option is chosen the menu display returns home and the CONFIG option on the Main Menu indicates that it is locked. Also all menus are locked out with the exception of the Contrast Adjustment menus and the Configuration Lock Menu. When the UNLOCK CFG option is chosen the configuration is unlocked and the menu display continues to the next sub-main menu.

2.4.3 Saving and Recalling Setups

The calibrator will automatically save the current set-up for recall at power-up. Additionally 5 set-ups can be accessed through the SETUPS menu. Select the SETUPS option from the Setups Main Menu.



Choose SAVE to save a set-up, RECALL to recall the set-up, or DONE to do nothing and return home.



If SAVE or RECALL is selected use the arrow keys to select the set-up location. Then use the save option to store the current set-up into the selected location or the recall option to recall the set-up stored in the selected location. The display menu will automatically go home.

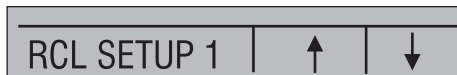

2.4.4 Setting AutoShut-off Parameters

The calibrator can be set to automatically shut-off after a selected number of minutes; this function can also be disabled. To set the auto shut off parameters select the AUTO OFF option on the Auto Shut Off Main Menu.



Use the arrow keys to select the number of minutes before the calibrator turns off or disable auto shut-off by scrolling all the way down.

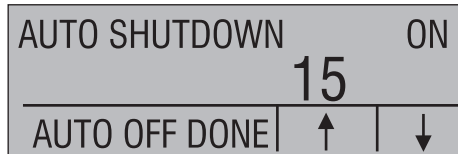

Use the AUTO OFF DONE option to set the parameters and return home. The auto shut off time is reset whenever a key is pressed.

2.4.5 Activating and Deactivating a Display

Use the DISPLAY option on the Display Selection Main Menu to access the Display Activation Menu.



The {function} option can be used to select which display to act upon. The ON/OFF option turns the selected display on or off. The selected display and current on/off state are displayed in the lower display.

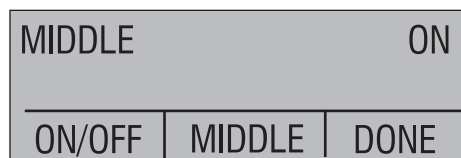

Use the DONE option to save the changes and return home. When a display is deactivated its configuration is retained. When the display is activated its configuration is

checked against the configurations of the other currently active displays, if the configurations are in conflict the recalled display's configuration is modified to avoid the conflict. If all three displays are deactivated the LOWER display will come on automatically

2.4.6 Low resolution function.

Due to the high accuracy of the 311A/321A the measured values are displayed with many digits, this might be an disadvantage in some cases, therefore the 311A/321A has a low resolution function. The function takes away the last digit.

To turn the function on or off, proceed as follows:

1. With the calibrator turned on and operating press the F3 key to activate the MORE menu option. Press the NEXT button until RESOLUTION appears in the left text field. Now press the F1 key to enter the function.



2. The select ON or OFF to turn the low resolution function on or off.

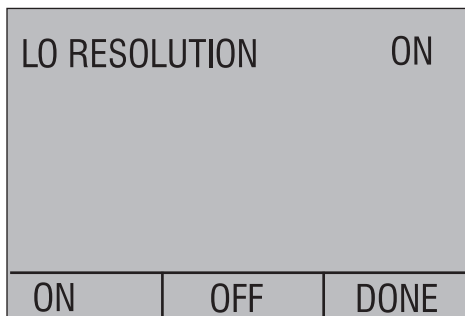

3. Pressing DONE returns to main menu.

2.4.7 Switching HART resistor on or off.

The calibrator has a built in 250 ohms serial "HART" resistor, to prevent communication errors on live HART networks, while calibrating 4-20 mA output from pressure transmitters. The resistor is switched into the loop, as a serial resistor.

To change switch in or out the HART resistor proceed as follows:

1. With the calibrator turned on and operating press the F3 key to activate the MORE menu option. Press the NEXT button until HART appears in the left text field. Now press the F1 key to enter the setup.

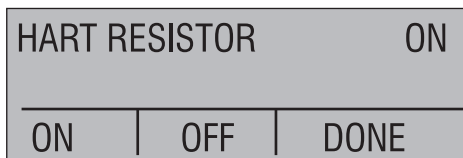

2. Switches the resistor on or off.
3. DONE returns to main menu.

2.4.8 Setting the RTD probe type

Use the PROBE TYPE option of the RTD Probe Type main menu to access the RTD Probe selection menu.



There are four probe types to select from P100-385, P100-392, P100-JIS and CUSTOM. Use the SELECT option to select the desired probe type and the DONE option to store the change and return home.

Note: The default probe type is PT100-385.

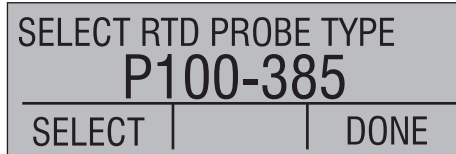

2.4.9 Damping

Damping can be turned ON or OFF using the Damping menu selection. When damping is ON, the calibrator displays an running average reading of ten measurements. The calibrator makes approximately 3 readings per second.

3. Measuring Pressure

To measure pressure, connect the calibrator using an appropriate fitting. Choose a pressure setting for the display being used. The calibrator is equipped with two internal sensors and many optional external sensors (EPMs) are available. Be sure to choose the sensor based on working pressures and accuracy.



Note:

Pressure sensors may be damaged and/or personnel injury may occur due to improper application of pressure. Please refer to the table of ranges and resolutions at the back of this manual for information on overpressure and burst pressure ratings. Vacuum should not be applied to any gauge pressure sensor. The calibrator display will indicate "OL" when an inappropriate pressure is applied. If "OL" is observed on any pressure display, the pressure should be reduced or vented immediately to prevent damage or possible personnel injury. "OL" is displayed when the pressure exceeds 120% of the nominal range of the sensor or when a vacuum in excess of 2 PSI is applied on gauge range sensors.

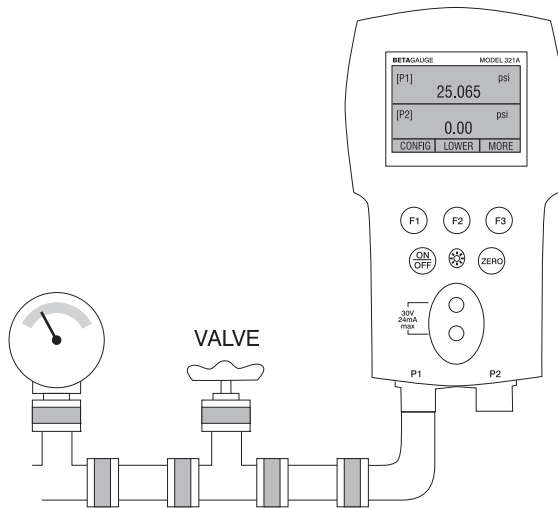

Figure 5

Use the (ZERO) key to zero the pressure sensor when vented to atmospheric pressure.

Important NOTE: To protect sensor integrity and prevent damage to the sensor, the calibrator will display OL [overload] when the applied pressure exceeds 120% of the full scale calibrated range of the sensor.

Important NOTE: To ensure accuracy of the calibrator it is critical to zero the calibrator before a device is calibrated.

3.1 Media Compatibility

The calibrator utilizes a media isolated sensor to prevent sensor contamination. Whenever possible clean, dry air is the media of choice. If that is not always possible, make sure that the media is compatible with Nickel Plated Brass and 316 Stainless Steel.

3.2 Measuring Pressure with External Modules

The calibrator provides a digital interface to External Pressure Modules. These modules are available in various ranges and types including gauge, vacuum, differential and absolute. The modules work seamlessly with the calibrator. Simply plug them into the interface and select [EXT] (external sensor). Since the interface between the calibrator and the module is digital all the accuracy and display resolution is derived from the module.

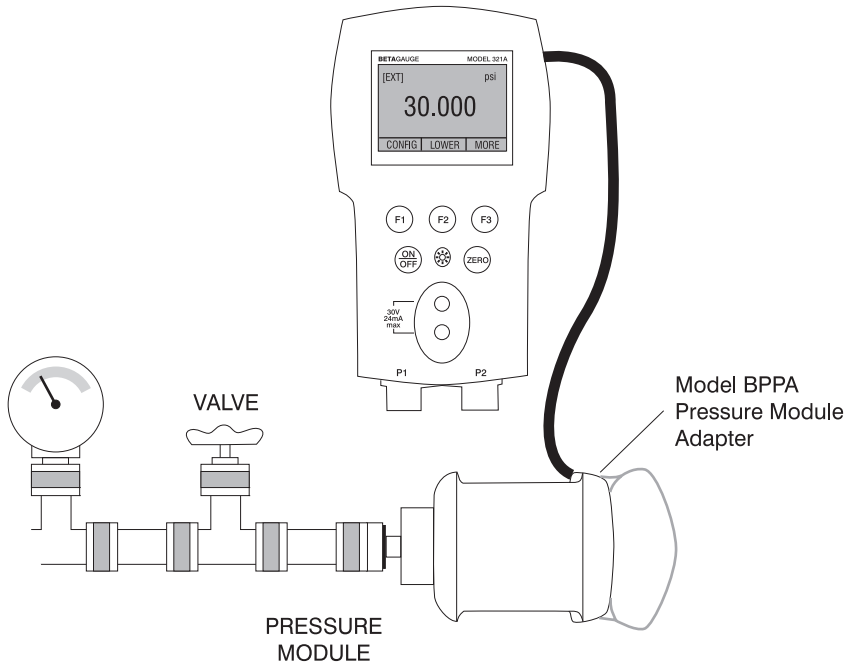

Figure 6

4. Measuring Current

To measure current use the input terminals in the front of the calibrator. Select the mA function on one of the displays. Current is measured in mA and percentage of range. The range on the calibrator is set to 0% at 4 mA and 100% at 20 mA.

Note: The display will indicate "OL" when the measured current exceeds the nominal range of current measurement (24 milliAmps).

For example:

If the current measured is displayed as 75% then the mA value is 16 mA.

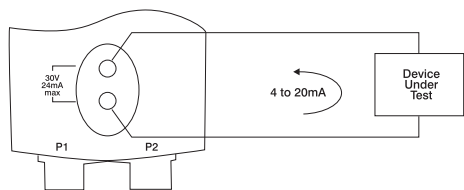
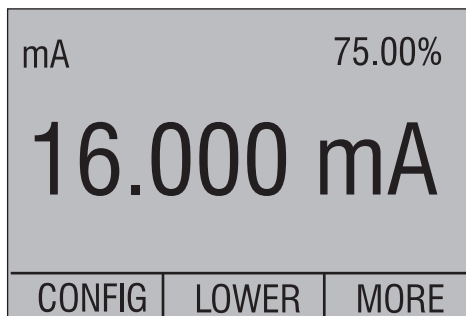

Figure 7

5. Measuring Voltage

To measure voltage use the input terminals in the front of the calibrator. Select the Volts function on one of the displays. The calibrator can measure up to 30V.

Note: The display will indicate “OL” when the measured voltage exceeds the nominal range of voltage measurement (30 V).

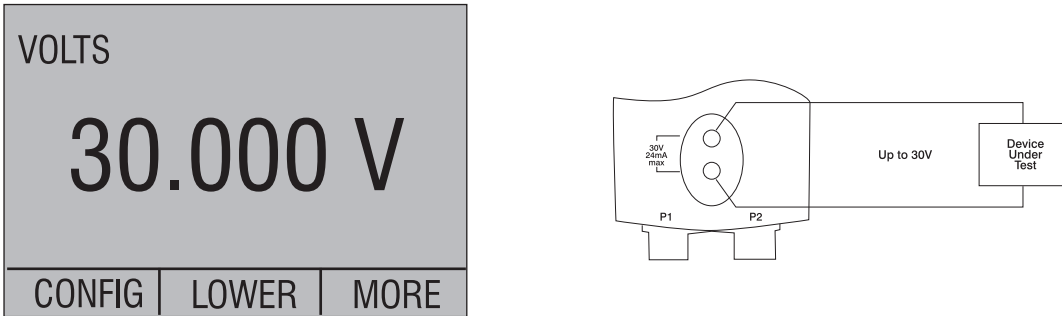

Figure 8

6. Measuring Temperature with an RTD

To measure temperature using an RTD probe you must select the RTD function on one of the displays. Make sure the proper probe type is selected. There are 4 probe types supported, P100-385, P100-392, P100-JIS and CUSTOM. The standard probe has a 9” insertion depth with a 3/16” diameter stainless steel sheath.

Note: The factory default type is PT100-385 so if the 311A/321A is being used with the Martel Model LPT100A probe you do not have to set the probe type. Simply plug the probe into the 311A/321A and configure the display to read temperature.

Note: The display will indicate “OL” when the measured temperature is outside the nominal measurement range of the RTD function (below -40°C or above 150°C).

If a custom probe is being used, the entering of R0 and coefficients is handled through the serial interface (see section 11).

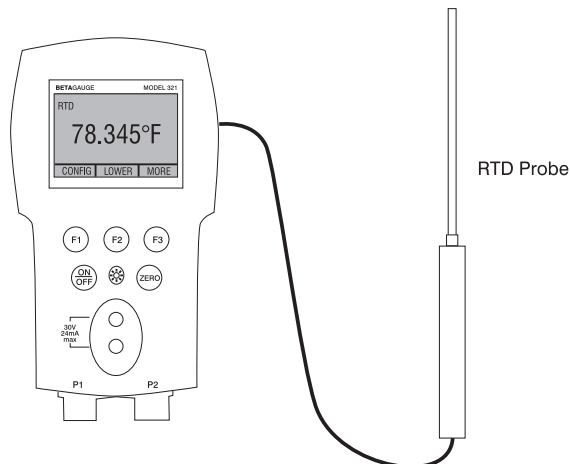

Figure 9

7. Performing a Pressure Switch Test

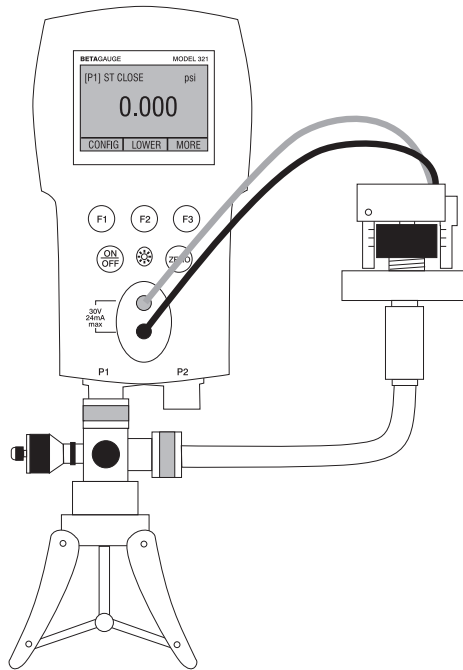

Figure 10

To perform a switch test, follow these steps:

1. Change the setup to Setup 4 (default switch test).

Setup 4: The upper display is set to [P1] ST, all other displays are off.

Important NOTE: The pressure Switch Test can be performed with the following functions [P1] ST, [P2] ST, or EXT ST.

2. Connect the calibrator to the switch using the pressure switch terminals. The polarity of the terminals does not matter. Then connect the pump to the calibrator and the pressure switch.
3. Make sure the vent on the pump is open. Zero the calibrator if necessary. Close the vent after zeroing the calibrator.
4. The top of the display will read "CLOSE".

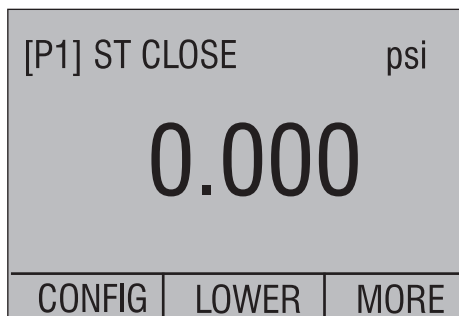

5. Apply pressure with the pump slowly until the switch opens.

Important NOTE: In the switch test mode the display update rate is increased to help capture changing pressure inputs. Even with this enhanced sample rate pressurizing the device under test should be done slowly to ensure accurate readings.

6. Once the switch is open, "OPEN" will be displayed, bleed the pump slowly until the pressure switch closes.

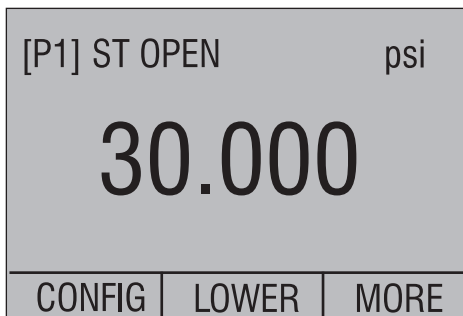

7. At the top of the display it will now read, "SW OPENED AT" and give you the pressure that the switch opened at.



8. Press the "NEXT" option to view when the switch closed, and the dead band.

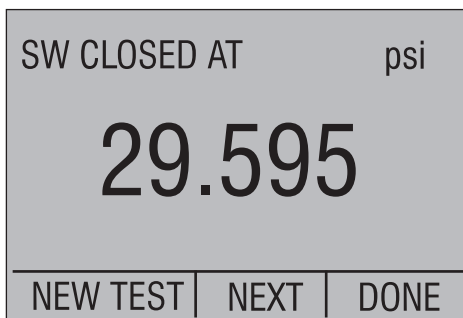

SW DEADBAND		psi
0.405		
NEW TEST	NEXT	DONE

9. Press the “NEW TEST” option to clear the data and perform another test.
10. Press the “DONE” option to end the test and return to the standard pressure setting.

Example: [P1] ST will return to [P1].

Important NOTE: The previous example uses a normally closed switch. The basic procedure is still the same for a normally open switch, the display will just read “OPEN” instead of “CLOSE”.

8. Calibrating Transmitters

8.1 Using the mA Input Function

The mA input function allows the user to read back the 4-20 mA output from the device being calibrated. This can be done in one of two ways.

- 1) Passively – Where the device under test directly generates 4-20 mA and can be read by the calibrator.
- 2) Actively – Where the calibrator supplies 24 VDC loop power to the device under test to power the device while reading the resulting 4-20 mA signal.

[P1]	psi	
30.000		
mA	100.00%	
20.000 mA		
CONFIG	LOWER	MORE

[P1]	psi	
30.000		
mA LOOP	100.00%	
20.000 mA		
CONFIG	LOWER	MORE

8.2 Calibrating a Pressure-to-Current Transmitter (P/I)

To calibrate a pressure-to-current transmitter (P/I), perform the following steps:

1. Connect the calibrator and the pump to the transmitter.
2. Apply pressure with the pump.
3. Measure the current output of the transmitter.
4. Ensure the reading is correct. If not, adjust the transmitter as necessary.

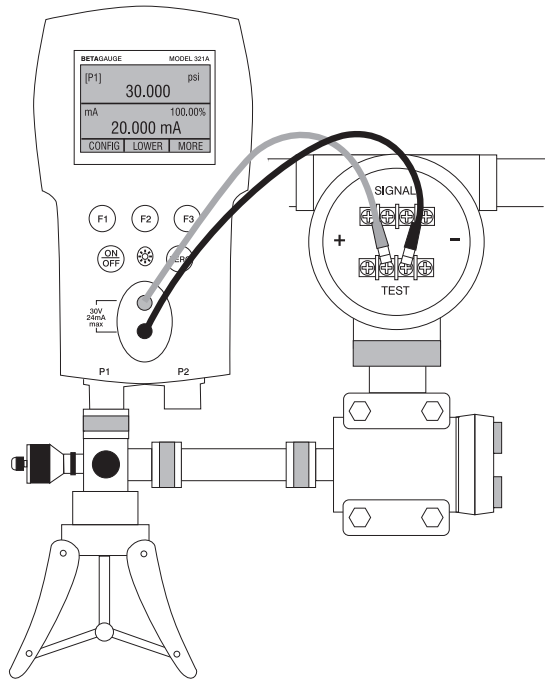

Figure 11.

8.3 Percent Error Function

The calibrator features a unique function which can calculate pressure vs. milliamp error as a percentage of the 4 to 20 mA loop span. The percent error mode uses all 3 screens and has a unique menu structure. It simultaneously displays pressure, mA and percent error.

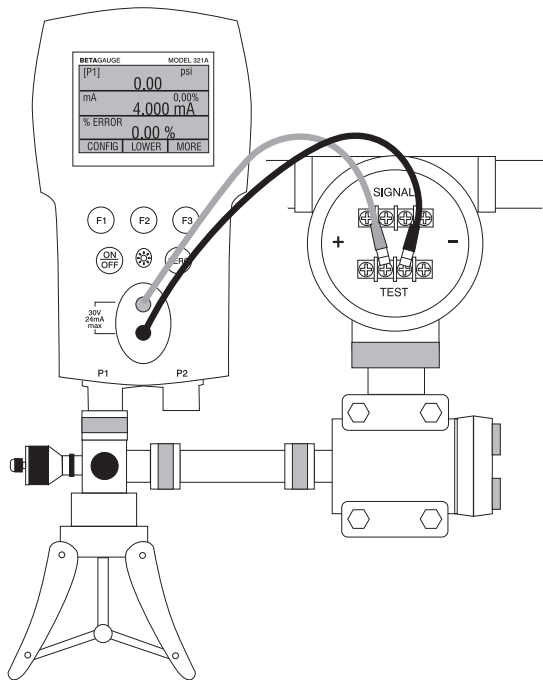

Figure 12.

Example:

Suppose a pressure transmitter under test is 30 psi (2 Bar) Full Scale and outputs a corresponding 4 to 20 mA signal. The user can program in a 0 to 30 psi pressure span into the calibrator and the calibrator will calculate and display the deviation or % Error from the expected 4 to 20 mA output. This eliminates the need for manual calculations and also helps if it becomes difficult to set an exact pressure with an external pump.

To use the %ERROR function proceed as follows:

1. With the calibrator turned on and operating press the F3 key to activate the MORE menu option. Now press the F1 key to activate the %ERROR option.
2. Press the F1 key to select the CONFIG option.
3. The first option is setting the Port, use the select option to scroll through the port choices, when finished select the NEXT option.

% ERROR PORT		[P1]
SELECT	NEXT	DONE

4. LOOP POWER can be toggled on/off, select NEXT when done.

LOOP POWER		OFF
ON	OFF	NEXT

5. Use SELECT to toggle through the UNIT options, and select NEXT to move on.

SET UNIT		psi
SELECT	NEXT	DONE

6. Use the ↑ and ↓ arrows to set the 100% point of the desired pressure range, select DONE SET when finished.

SET 100% BELOW		psi
30.000		
DONE SET	↑	↓

7. Again, use the arrows to set 0% point and select DONE SET when finished and the %ERROR mode will be ready to use.

SET 0% BELOW		psi
0.000		
DONE SET	↑	↓

Note: The 0% and 100% point will be saved in non-volatile memory until they are changed again by the user for the internal sensors, and external pressure modules. When using an external module the 0% and 100% are set to low and full scale of the module until the user changes it, or if it was previously saved.

[P1]	0.0000	psi
[P2]	0.00	psi
RTD	85.78	°F
CONFIG	LOWER	MORE

9. Minimum and Maximum Storage Capability

The 300 Series Pressure Calibrators have a min/max feature for capturing the minimum and maximum values of any displayed parameter.

The min/max function can be accessed by stepping through the menu options until “min/max” is shown on the display above the F1 key. At this time, pressing the F1 key will toggle the display through the min/max values that are stored in the min/max registers. These readings are live so that the new min/max values will be recorded while in this mode.

[P1]	-0.003	psi
mA	4.000	-25.00% mA
MIN	CLEAR	DONE

[P1]	30.000	psi
mA	20.001	-25.00% mA
MAX	CLEAR	DONE

To reset the min/max registers simply press the clear key. These registers are also cleared at power-up or when the configuration is changed.

10. Factory Setups

The Calibrator is loaded with five factory setups. These setups are shown below.

Setup 1: The upper display is set to [P1] mode and the middle is set to mA, lower is off.

[P1]	psi	
30.000		
mA	100.00%	
20.000 mA		
CONFIG	UPPER	MORE

Setup 2: The upper display is set to [P2] mode and the middle is set to mA, lower is off.

[P2]	psi	
30.000		
mA	100.00%	
20.000 mA		
CONFIG	UPPER	MORE

Setup 3: The upper display is set to [P1] mode and the middle is set to [P2], lower is off.

[P1]	psi	
10.000		
[P2]	psi	
30.000		
CONFIG	UPPER	MORE

Setup 4: The lower display is set to [P1] switch test, the other displays are off.

[P1] ST CLOSE psi		
0.000		
CONFIG	LOWER	MORE

Setup 5: The upper display is set to [P1], the middle display is set to [P2] and the lower display is set to RTD.

[P1]	0.0000	psi
[P2]	0.00	psi
RTD	85.78	°F
CONFIG	LOWER	MORE

11. Custody Transfer / Flow Calibration

The Model 311A/321A is ideal for flow computer calibration. Every manufacturer of flow computers has a different calibration procedure, but most call for calibration of three parameters: static pressure, differential pressure and temperature. To facilitate these measurements recall setup #5 on the 311A/321A.

Note: The pressures in the UPPER, and MIDDLE displays can be changed to [P1], [P2], and EXT.

1. Connect the calibrator to your static and differential pressures. ([P1], [P2], EXT) Then connect the RTD sensor to the calibrator.
2. Using the reading of your RTD, static, and differential pressures make sure the flow computer has the correct reading. If not, adjust the flow computer as necessary.

12. Remote Operation

12.1 Remote Interface

The calibrator can be remotely controlled using a PC terminal, or by a computer program running the calibrator in an automated system. It uses an RS-232 serial port connection for remote operation. **NOTE: To use the remote control option a custom RS-232 cable must be purchased from Martel (LEM232). To contact Martel refer to Section 1.1 of this manual.** With this connection the user can write programs on the PC, with Windows languages like Visual Basic to operate the calibrator, or use a Windows terminal, such as Hyper Terminal, to enter single commands. Typical RS-232 remote configurations are shown in Figure 13.

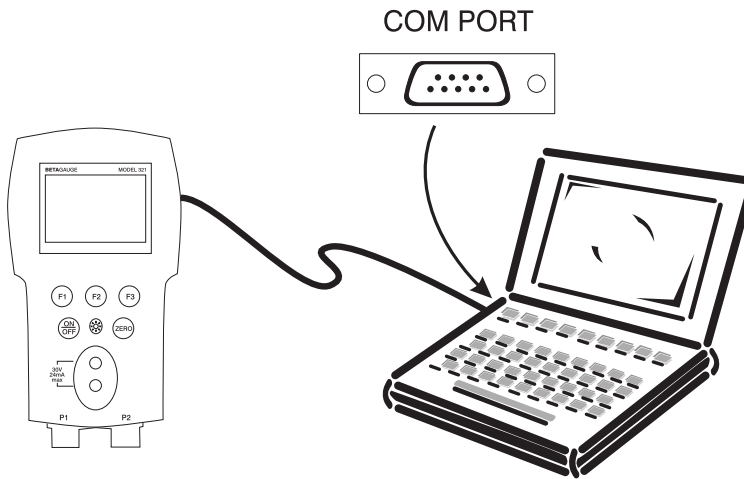

Figure 13. Calibrator-to-Computer Connection

12.2 Setting up the RS-232 Port for Remote Control

Note: The RS-232 connection cable should not exceed 15m unless the load capacitance measured at connection points is less than 2500pF.

Serial parameter values:

9600 baud

8 data bits

1 stop bit

no parity

Xon/Xoff

EOL (End of Line) character or CR (Carriage Return) or both

The LEM232 cable is used for RS-232 communications from the calibrator to a computer. If the computer only has USB type ports, a USB to RS-232 converter will be needed. These can be obtained from most office supply and computer stores. To connect the calibrator to the computer, attach the LEMO connector end of the cable to the pressure

module port on the right side of the calibrator and the DB-9 connector to the RS-232 port on the computer. The calibrator should be turned off prior to making the connection and then turned on.

To set up remote operation of the calibrator on the Windows Hyper Terminal, connected to a COM port on the PC as in Figure 23, use the following procedure:

1. Start Hyper Terminal (located in Accessories/Communications of the Windows Start menu)
2. Select New Connection.
3. For Name enter Beta 311A/321A. Select the serial port that the calibrator is connected to.
4. Enter the above information for port settings.
5. Select ASCII setup from File/Properties/Settings and mark these choices:
 - Echo typed characters locally
 - Wrap lines that exceed terminal width
6. Select Ok
7. To see if the port works enter *IDN?. This command will return information on the calibrator.

12.3 Changing Between Remote and Local Operation

There are three modes of operation of the calibrator, Local, Remote, and Remote with Lockout. Local mode is the default mode. Commands may be entered using the keypad on the calibrator or using a computer. In Remote mode the keypad is disabled, and commands may only be entered using a computer, but choosing [GO TO LOCAL] from the menu on the calibrator display will restore keypad operation. In Remote with Lockout, the keypad can not be used at all. To switch modes proceed as follows:

1. To enable Remote mode, type in the serial command REMOTE at the computer terminal.
2. To enable Remote with Lockout, type in "REMOTE LOCKOUT" in either order.
3. To switch back to local operation enter LOCAL at the terminal. This command also turns off LOCKOUT if it was on. For more information on commands refer to the Remote Commands section.

12.4 Using Commands

12.4.1 Command types

Refer to the Section 10.5 on Remote Commands for all available commands.

The calibrator may be controlled using commands and queries. All commands may be entered using upper or lower case. The commands are divided into the following categories:

Calibrator Commands

Only the calibrator uses these commands. For example

VAL?

asks for the values displayed on the calibrator display.

Common Commands

Standard commands used by most devices. These commands always begin with an “*”.

For example

```
*IDN?
```

tells the calibrator to return its identification.

Query Commands

Commands that ask for information, they always end with a “?”. For example:

```
FUNC?
```

Returns the current modes of the calibrator displays.

Compound Commands

Commands that contain more than one command on one line. For example;

```
RTD_TYPE PT385_100;RTD_TYPE?
```

Sets the calibrator to RTD type PT385_100 and queries it to verify. It will return:

```
PT385_100
```

12.4.2 Character Processing

The data entered into the calibrator is processed as follows:

- ASCII characters are discarded if their decimal equivalent is less than 32 (space), except 10 (LF) and 13 (CR):
- Data is taken as 7-bit ASCII
- The most significant data bit is ignored.
- Upper or lower case is acceptable.

12.4.3 Response Data Types

The data returned by the calibrator can be divided into four types:

Integer

For most computers and controllers they are decimal numbers ranging from -32768 to 32768. For example:

```
FAULT? could return 110
```

Refer to the Error Codes table (Table 8) for more information on error codes.

Floating

Floating numbers have up to 15 significant figures and exponents. For example:

```
CPRT_COEFA? returns 3.908300E-03
```

Character Response Data (CRD)

Data returned as keywords. For example:

```
RTD_TYPE? returns PT385_100
```

Indefinite ASCII (IAD)

Any ASCII characters followed by a terminator. For example:

*IDN? returns BETA, 311A/321A, 250, 1.00

12.4.4 Calibrator Status

Error Queue

If an error occurs due to invalid input or buffer overflow, its error code is sent to the error queue. The error code can be read from the queue with the command FAULT?. The error queue holds 15 error codes. When it is empty, FAULT? returns 0. The error queue is cleared when power is reset or when the clear command *CLS is entered.

Input Buffer

Calibrator stores all received data in the input buffer. The buffer holds 250 characters. The characters are processed on a first in, first out basis.

12.5 Remote Commands and Error Codes

The following tables list all commands, and their descriptions, that are accepted by the calibrator.

Table 5: Common Commands

Command	Description
*CLS	(Clear status.) Clears the error queue.
*IDN?	Identification query. Returns the manufacturer, model number, and firmware revision level of the Calibrator.
*RST	Resets the calibrator to the power up state.

Table 6: Calibrator Commands

Command	Description
CPRT_COEFA	Sets the custom RTD coefficient A
CPRT_COEFA?	Returns the custom RTD coefficient A
CPRT_COEFB	Sets the custom RTD coefficient B
CPRT_COEFB?	Returns the custom RTD coefficient B
CPRT_COEFC	Sets the custom RTD coefficient C
CPRT_COEFC?	Returns the custom RTD coefficient C
CPRT_R0	Sets the custom RTD R0 resistance
CPRT_R0?	Returns the custom RTD R0 resistance
DAMP	Turns Damp on or off.
DAMP?	Returns if DAMP is on/off
DISPLAY	Turns on/off the displays specified in the command
DISPLAY?	Returns which displays are on/off
FAULT?	Returns the most recent error code

ERROR_LOOP	Turns loop power on or off in percent error mode
ERROR_LOOP?	Returns the current state of loop power in error mode
ERROR_MODE	Turns percent error mode on or off
ERROR_MODE?	Returns whether percent error mode is on or off
ERROR_PORT	Set the pressure port for percent error mode
ERROR_PORT?	Returns the pressure port for percent error mode
FUNC	Sets the display mode as specified in the command
FUNC?	Returns the current mode of the upper, middle, and lower display
HI_ERR	Sets the 100% of span limit for percent error mode
HI_ERR?	Returns the 100% of span limit for percent error mode
LOCAL	Returns user to manual operation of the calibrator
LOCKOUT	Locks out the keypad of the calibrator in remote operation
LO_ERR	Sets the 0% of span limit for percent error mode
LO_ERR?	Returns the 0% of span limit for percent error mode
OHMS?	Returns ohms value measured from the RTD
PRES_UNIT	Set the pressure unit for the indicated display
PRES_UNIT?	Returns the pressure from the indicated display
REMOTE	Puts the calibrator in remote mode
RTD_TYPE	Sets the RTD type
RTD_TYPE?	Returns the RTD type
ST_START	Starts a switch test
ST_OPEN?	Returns pressure value at which the switch opened
ST_CLOSE?	Returns pressure value at which the switch closed
ST_DEAD?	Returns pressure value of the deadband of the switch
TEMP_UNIT	Set the RTD to read in °F or °C on the indicated display
TEMP_UNIT?	Returns the unit the RTD is set to read on the indicated display
VAL?	Returns the measured values
ZERO_MEAS	Zeros the pressure module
ZERO_MEAS?	Returns the zero offset of the pressure module
HART_ON	Turns Hart Resistor on
HART_OFF	Turns Hart Resistor off
HART?	Returns status of Hart Resistor

Table 7: Parameter units

Units	Meaning
MA	milliamps of current
V	Voltage in volts
CEL	Temperature in Celsius
FAR	Temperature in Fahrenheit

OHM	Resistance in Ohms
PSI	Pressure in pounds per square-inch
INH2O4C	Pressure in inches of water at 4°C
INH2O20C	Pressure in inches of water at 20°C
INH2O60F	Pressure in inches of water at 60°F
CMH2O4C	Pressure in centimeters of water at 4°C
CMH2O20C	Pressure in centimeters of water at 20°C
BAR	Pressure in bars
MBAR	Pressure in millibars
MPAL	Pressure in MegaPascals
KPAL	Pressure in kiloPascals
INHG	Pressure in inches of mercury at 0°C
MMHG	Pressure in millimeters of mercury at 0°C
KG/CM2	Pressure in kilograms per square-centimeter
MMH2O4C	Pressure in millimeters of water at 4°C
MMH2O20C	Pressure in millimeters of water at 20°C
FTH2O60F	Pressure in feet of water at 60°F
ON	Turn something on
OFF	Turn something off
UPPER	Upper Display
MIDDLE	Middle Display
Lower	Lower Display
DCI	Current measure function
DCI_LOOP	Current measure function with loop power
DCV	Voltage measure function
RTD	Temperature measure function
P1	Port P1 pressure measure function
P2	Port P2 pressure measure function
P1_ST	Switch Test with port P1 pressure measure function
P2_ST	Switch Test with port P2 pressure measure function

Table 8: Error Codes

Error Number	Error Description
100	A non-numeric entry was received where it should be a numeric entry
101	Too many digits entered
102	Invalid units or parameter value received
103	Entry is above the upper limit of the allowable range
104	Entry is below the lower limit of the allowable range
105	A required command parameter was missing

106	An invalid command parameter was received
107	Pressure not selected
108	Invalid sensor type
109	Pressure module not connected
110	An unknown command was received
111	Bad Parameter received
112	The serial input buffer overflowed
113	Too many entries in the command line
114	The serial output buffer overflowed

12.6 Entering Commands

Commands for the calibrator may be entered in upper or lower case. There is at least one space required between the command and parameter, all other spaces are optional. Almost all commands for the calibrator are sequential; any overlapped commands will be indicated as such. This section will briefly explain each of the commands and describe their general use, which will include any parameters that may be entered with the command as well as what the output of the command is.

12.6.1 Common Commands

***CLS**

Clears the error queue. Also terminates all pending operations. When writing programs, use before each procedure to avoid buffer overflow.

***IDN?**

Returns the manufacturer, model number, and firmware revision of the Calibrator. For example:

*IDN? will return BETA, 311A/321A, 0, 1.00

12.6.2 Calibrator Commands

CPRT_COEFA

This command is used for entering a custom RTD into the calibrator. The numeric value entered after the command will be set as the first coefficient of the polynomial used by the custom RTD.

For example:

CPRT_COEFA 3.908300E-03 enters 3.908300e-3 as coefficient A.

CPRT_COEFA?

Returns the number that was entered for the first coefficient of the polynomial used in the custom RTD. Using the example above CPRT_COEFA? Would return:

3.908300E-03

CPRT_COEFB

This command is used for entering a custom RTD into the calibrator. The numeric value entered after the command will be set as the second coefficient of the polynomial used by the custom RTD.

For example:

CPRT_COEFB -5.774999E-07 enters -5.774999E-07 as coefficient B.

CPRT_COEFB?

Returns the number, which was entered for the second coefficient of the polynomial used in the custom RTD. Using the example above, CPRT_COEFB? Would return:

-5.774999E-07

CPRT_COEFC

This command is used for entering a custom RTD into the calibrator. The numeric value entered after the command will be set as the first coefficient of the polynomial used by the custom RTD.

For example:

CPRT_COEFC -4.183000E-12 enters -4.183000E-12 as coefficient C.

CPRT_COEFC?

Returns the number that was entered for the third coefficient of the polynomial used in the custom RTD. Using the example above CPRT_COEFC? Would return:

-4.183000E-12

CPRT_R0

Sets the 0° resistance, R0, in the custom RTD. The value must be entered with a units label. Refer to the Parameter Units table for assistance.

For example:

CPRT_R0 100 OHM sets R0 to 100 ohms.

CPRT_R0?

Returns the value for the resistance in custom RTD. The above example would return:

1.000000E+02, OHM

DAMP

Turns the dampening function on or off.

For example:

If you send DAMP ON this will turn the dampening function on.

DAMP?

Returns the current state of the dampening function.

For example:

If you send DAMP? It will return ON if the dampening function is on.

DISPLAY

Turns the indicated display on or off.

For example:

If you send DISPLAY LOWER, ON this will turn the lower display on.

DISPLAY?

Returns the current state of the each of the displays.

For example:

If you send DISPLAY? It will return ON, ON, ON if the all the displays are on.

FAULT?

Returns the error code number of an error that has occurred. The command may be entered when the previous command did not do what it was meant to do.

For example, if a value for current output is entered that is bigger than the supported range (0-24mA) FAULT? Would return:

103 which is the code number for an entry over range.

Refer to the Error Codes table for more information on error code numbers.

ERROR_LOOP

Turns loop power on or off in percent error mode.

For example:

To set loop power on send ERROR_LOOP ON.

ERROR_LOOP?

Returns the current state of loop power in percent error mode.

For example:

If you send ERROR_LOOP? It will return ON if loop power is on in error mode.

ERROR_MODE

Turns percent error mode on and off.

For example:

To turn on percent error mode send ERROR_MODE ON.

ERROR_MODE?

Returns the current state of percent error mode.

For example:

If you send ERROR_MODE? It will return ON if the calibrator is in percent error mode.

ERROR_PORT

Sets the pressure port for percent error.

For example:

To set the pressure port for percent error to [P1] send ERROR_PORT P1.

ERROR_PORT?

Returns the current pressure port for percent error mode.

For example:

If you send ERROR_PORT?, it will return P1 if the pressure port in percent error is [P1].

FUNC

Sets the display indicated in argument one to the function indicated in argument 2.

For example:

To set the lower display to RTD mode send FUNC LOWER,RTD.

FUNC?

Returns the current mode of all displays. For example if the calibrator is set to [P2] ST on the upper display, [P1] on the middle, and RTD on the lower, FUNC? Would return:

ST_P2,P1,RTD

HI_ERR

Sets the 100% point for the percent error mode calculation in the current engineering units.

For example:

To set the 100% point to 100 psi send HI_ERR 100.

HI_ERR?

Returns the 100% point for the percent error mode calculation.

For example:

If the 100% point is set to 100 psi, HI_ERR? would return 1.000000E+02, PSI .

LOCAL

Restores the calibrator to local operation if it was in remote mode. Also clears LOCKOUT if the calibrator was in lockout mode.

LOCKOUT

Sending this command sets the lockout state, when the unit is in REMOTE or goes to remote it prohibits use of the keypad completely. The lockout state can only be cleared by sending the LOCAL command.

LO_ERR

Sets the 0% point for the percent error mode calculation in the current engineering units.

For example:

To set the 0% point to 20 psi send LO_ERR 20.

LO_ERR?

Returns the 0% point for the percent error mode calculation.

For example:

If the 0% point is set to 20 psi, LO_ERR? would return 2.000000E+01, PSI .

OHMS?

Returns the raw Ohm value from the RTD.

For example:

If when measuring a P100-385 at 0 degrees cel sending OHMS? would return 1.000000E+02, OHM .

PRES_UNIT

Used to set the pressure unit for the indicated display

For example:

To set the pressure unit to psi on the lower display send PRES_UNIT LOWER, PSI.

PRES_UNIT?

Returns the pressure unit used when measuring pressure for each of the 3 displays.

REMOTE

Puts the calibrator in remote mode. From the remote mode the user can still use the keypad to get back to local unless the command LOCKOUT was entered before REMOTE. Than the keypad is totally locked out, and the user has to send the LOCAL command to get back to local operation.

RTD_TYPE

Sets the RTD type. The following is a list of RTD types the way they should be entered after the command:

PT385_100; PT392_100; PTJIS_100; CUSTOM;

For Example:

RTD_TYPE PT385_100 sets RTD type to PT100-385

RTD_TYPE?

Returns the RTD type.

For Example:

If the RTD type is PT385_100, RTD_TYPE? Will return PT100_385.

ST_START

Starts a switch test.

ST_CLOSE?

Returns the pressure that the switch closed at in the current pressure units.

ST_OPEN?

Returns the pressure that the switch opened at in the current pressure units.

ST_DEAD?

Returns deadband of the switch in the current pressure units.

TEMP_UNIT

This command is used to the temperature unit used when measuring temperature.

The first argument indicates which display to apply the change to. The second argument is the unit, either CEL for Celsius or FAR for fahrenheit.

For example:

To set the temperature unit to fahrenheit on the lower display send TEMP_UNIT LOWER, FAR.

TEMP_UNIT?

Returns the temperature unit, (CEL or FAR) used when measuring RTDs for each of the 3 displays.

VAL?

Returns the value of any measurement taking place on the upper and lower display. For example, if the upper display is measuring 5mA, and the lower display is measuring 10V, then VAL? will return:
5.000000E-03, A, 1.000000E+01, V

ZERO_MEAS

Zeroes the attached pressure module. Enter the zeroing value in PSI after the command when zeroing an absolute pressure module.

ZERO_MEAS?

Returns the zero offset or the reference value for absolute pressure modules.

HART_ON

Turns Hart mode on.

HART_OFF

Turns Hart mode off.

HART?

Returns status of Hart mode, ON or OFF.

13. Specifications (18 °C to 28 °C unless otherwise noted.)

General

Instrument Setup Recall	5; last used on power-up
Environmental Operating Temperature Storage Temperature	-10 °C to +50 °C -20 °C to +60 °C
Power Requirements Battery Battery Life	6.0 VDC Four (4) standard AA cells > 35 hours, typical usage
Physical Dimensions Weight	8.3" H x 3.9" W x 1.8" D (21.082 x 9.906 x 4.572 cm) 1 lb. 4 oz. (0.567 kg)
EMI/RFI Conformance	EN50082-1: 1992 and EN55022: 1994 Class B
Connectors/Ports	Pressure - two, 1/8" NPT BetaPort-P pressure module adapter; RTD probe
Included Accessories	Soft case, batteries, manual, NIST-traceable certificate, and test leads

Ranges

Available Pressure (select any two) Gauge: 0.3 psi, 1 psi, 5 psi, 15, psi, 30, psi, 100 psi, 300 psi, 500 psi, 1000 psi, 3000 psi, 5000 psi, 10,000 psi Absolute: 15 psi, 30 psi, 100 psi, 300 psi. Compound: -15 to 15 psi, -15 to 30 psi. (see table of ranges and resolutions for more information)	
mA	0 to 24.000 mA
Volts	0 to 30.000 VDC
RTD	-40.0°C to 150.0°C (-40.0°F to 302.0°F)
Engineering Units	psi, bar, mbar, kPa, MPa, kgcm2, mmH ₂ O @ 4°C, mmH ₂ O @ 20°C, cmH ₂ O @ 4°C, cmH ₂ O @ 20°C, inH ₂ O @ 4°C, inH ₂ O @ 20°C, inH ₂ O @ 60°F, mmHg @ 0°C, inHg @ 0°C

Accuracy

Pressure	
0.3 psi	±0.1% F.S.
1.0 psi	±0.05% F.S.
15 psi through 3000 psi	±0.025% F.S.
5 psi, 5000 psi, 10,000 psi	±0.035% F.S.
mA	±0.015% of rdg ±0.002mA
Volts	±0.015% of reading ±0.002V
RTD (ohms)	±0.015% of rdg ±0.02 ohms; or ±0.1°C @ 0°C for Pt100
Temperature Effect	
No effect on accuracy on all functions from 15°C to 35°C	
Add ±0.002% F.S./°C for temps outside of 15°C to 35°C	
Optional LPT100A Probe	Meets PT-100 ALPHA 385 Class "A" Specifications

14. Warranty

Martel Electronics Corporation warrants all products against material defects and workmanship for a period of twelve (12) months after the date of shipment. Problems or defects that arise from misuse or abuse of the instrument are not covered. If any product is to be returned, a "Return Material Authorization" form can be obtained from our website www.martelcorp.com under customer service. You can also call 1-800-821-0023 to have a form faxed. Martel will not be responsible for damage as a result of poor return packaging. Out of warranty repairs and recalibration will be subject to specific charges. Under no circumstances will Martel Electronics be liable for any device or circumstance beyond the value of the product.

15. Maintenance

15.1 Replacing Batteries

Replace batteries as soon as the battery indicator turns on to avoid false measurements. If the batteries discharge too deeply the 311A/321A will automatically shut down to avoid battery leakage.

Note: Use only AA size alkaline batteries or optional rechargeable battery pack.

15.2 Cleaning the Unit

Warning

To avoid personal injury or damage to the calibrator, use only the specified replacement parts and do not allow water into the case.

Caution

To avoid damaging the plastic lens and case, do not use solvents or abrasive cleansers. Clean the calibrator with a soft cloth dampened with water or water and mild soap.

15.3 Service Center Calibration or Repair

Only qualified service personnel should perform calibration, repairs, or servicing not covered in this manual. If the calibrator fails, check the batteries first, and replace them if needed.

Verify that the calibrator is being operated as explained in this manual. If the calibrator is faulty, call for an RMA number or go to www.martelcorp.com to download an RMA form to return the unit. Be sure to pack the calibrator securely, using the original shipping container if it is available.

BetaGauge 311A/321A Ranges and Resolutions

Range (PSI)	0.3	1	5	15	30	50	100	300	500	1000	1500	3000	5000	10000
Burst Pressure (PSI)	10	10	100	500	500	1000	1000	2000	2000	10000	10000	10000	10000	15000
Proof Pressure (PSI)	1	3	15	30	60	200	200	600	1000	3000	3000	6000	10000	15000
Engineering Unit	Factor													
Psi	1	1.0000	5.0000	15.0000	30.0000	50.0000	100.0000	300.0000	500.0000	1000.0000	1500.0000	3000.0000	5000.0000	10000.0000
bar	0.06894757	0.0689	0.3447	1.0342	2.0684	3.4447	6.8947	20.684	34.474	68.947	103.42	206.84	344.74	689.47
mbar	68.94757	68.948	344.74	1034.2	2068.4	3447.4	6894.8	20684	34474	68948	N/A	N/A	N/A	N/A
kPa	6.894757	6.8948	34.474	103.42	206.84	344.74	689.48	2068.4	3447.4	6894.8	10342	20684	34474	68948
MPa	.00689476	0.0021	0.0344	0.1034	0.2068	0.3447	0.6894	2.0684	3.4474	6.8948	10.342	20.684	34.474	68.948
kg/cm2	0.07030697	0.0211	0.3515	1.0546	2.1092	3.5153	7.0307	21.092	35.153	70.307	105.46	210.92	351.53	703.07
cmH2O @ 4°C	70.3089	21.093	351.54	1054.6	2109.3	3515.4	7030.9	21093	35154	70309	N/A	N/A	N/A	N/A
cmH2O @ 20°C	70.4336	21.130	352.17	1056.5	2113.0	3521.7	7043.4	21130	35217	70434	N/A	N/A	N/A	N/A
mmH2O @ 4 °C	703.089	210.93	3515.4	10546	21093	35154	70309	N/A	N/A	N/A	N/A	N/A	N/A	N/A
mmH2O @ 20°C	704.336	211.30	3521.7	10565	21130	35217	70434	N/A	N/A	N/A	N/A	N/A	N/A	N/A
inH2O @ 4°C	27.68067	8.3042	138.40	415.21	830.42	1384.0	2768.1	8304.2	13840	27681	41521	83042	N/A	N/A
inH2O @ 20°C	27.72977	8.3189	138.65	415.95	831.89	1386.5	2773.0	8318.9	13865	27730	41595	83189	N/A	N/A
inH2O @ 60°F	27.70759	8.3123	138.54	415.61	831.23	1385.4	2770.8	8312.3	13854	27708	41561	83123	N/A	N/A
mmHg @ 0°C	51.71508	15.515	258.58	775.73	1551.5	2585.8	5171.5	15515	25858	51715	77573	N/A	N/A	N/A
inHg @ 0°C	2.03602	61.081	10.180	30.540	61.081	101.80	203.60	610.81	1018.0	2036.0	3054.0	6108.1	10180	20360

• N/A - For calibrators with firmware version 2.0 and higher, some units will not be displayed due to limitations on display resolution. For calibrators with earlier versions of firmware, the calibrator will attempt to display a value, but the display will be excessively noisy to be useful. In all cases, best practice would prohibit the use of small engineering units such as mm H2O with high pressure range sensors.

• Proof pressure - maximum allowable pressure without a shift in calibration

• Burst pressure - sensor damaged or destroyed; some risk of personnel injury

• Compound ranges - the data for the 15 PSI range also applies to the -15 to +15 PSI compound range; the data for the 30 PSI range also applies to the -15 to +30 PSI compound range.

• Absolute ranges - the data for the 15, 30, 50, 100 and 300 PSI ranges also applies to the absolute pressure versions of those ranges.



www.martelcorp.com

e-mail: sales@martelcorp.com

Tel: (603) 434-1433 800-821-0023

Fax: (603) 434-1653

Martel Electronics

3 Corporate Park Dr.

Derry, NH 03038