

User's and Programmer's Reference

Volume 2

One-Button Power Measurements

PSA and ESA Series Spectrum Analyzers

Refer to Volume 1 for core spectrum analyzer information.

This manual provides documentation for the following instruments:

Agilent Technologies PSA Series

E4443A (3 Hz - 6.7 GHz)
E4445A (3 Hz - 13.2 GHz)
E4440A (3 Hz - 26.5 GHz)
E4447A (3 Hz - 42.98 GHz)
E4446A (3 Hz - 44.0 GHz)
E4448A (3 Hz - 50.0 GHz)

Agilent Technologies ESA-E Series

E4402B (9 kHz - 3.0 GHz)
E4404B (9 kHz - 6.7 GHz)
E4405B (9 kHz - 13.2 GHz)
E4407B (9 kHz - 26.5 GHz)

Agilent Technologies ESA-L Series

E4411B (9 kHz - 1.5 GHz)
E4403B (9 kHz - 3.0 GHz)
E4408B (9 kHz - 26.5 GHz)



Manufacturing Part Number: E4440-90618

Supersedes: E4440-90346

Printed in USA

March 2014

© Copyright 1999-2014 Agilent Technologies, Inc..

Legal Information

The information contained in this document is subject to change without notice.

Agilent Technologies makes no warranty of any kind with regard to this material, including but not limited to, the implied warranties of merchantability and fitness for a particular purpose. Agilent Technologies shall not be liable for errors contained herein or for incidental or consequential damages in connection with the furnishing, performance, or use of this material.

Where to Find the Latest Information

Documentation is updated periodically.

- For the latest information about Agilent Technologies **PSA** Spectrum Analyzers, including firmware upgrades and application information, please visit the following Internet URL:

<http://www.agilent.com/find/psa>

- For the latest information about Agilent Technologies **ESA** Spectrum Analyzers, including firmware upgrades and application information, please visit the following Internet URL:

<http://www.agilent.com/find/esa>

- To receive the latest updates by email, subscribe to Agilent Email Updates:

<http://www.agilent.com/find/emailupdates>

- Information on preventing spectrum analyzer damage can be found at:

<http://www.agilent.com/find/tips>

1. Using This Document

About the User's and Programmer's Information	26
What is in This Book	26
Terms Used in This Book	27

2. One-Button Measurement Functions

One - Button Measurement Functions	30
Mode Setup (Spectrum Analysis Mode)	33
Radio Std	33
Radio Std Setup	45
Retain Params	47
Enable All Measurements	47
Autorange of Power Setting (Remote command only)	48
MEASURE (Spectrum Analysis Mode)	49
Command Interactions: MEASure, CONFigure, FETCh, INITiate and READ	50
Current Measurement Query (Remote Command Only)	53
Test Current Results Against all Limits (Remote Command Only)	53
Meas Off	54
Channel Power	54
Occupied BW	57
Adjacent Channel Power—ACP	58
Multi-Carrier Power	62
Power Stat CCDF	64
Harmonic Distortion	67
Burst Power	70
Intermod (TOI)	73
Spurious Emissions	74
Spectrum Emission Mask	75
Meas Setup (Adjacent Channel Power—ACP)	83
Avg Number	83
Avg Mode	84
Chan Integ BW	84
Offset/Limits	85
Meas Type	89
Optimize Ref Level	90
Method	91
Total Pwr Ref	94
PSD Ref	95
Limit Test	96
RRC Filter	96
Filter Alpha	97
Noise Correction	97
Trace/View (ACP Measurement)	99
Spectrum	99
Bar Graph	99
Combined	100
Combined View Units	100
Trace	100
Meas Setup (Burst Power)	101

Contents

Avg Number	101
Avg Mode	102
Average Type	103
Threshold Lvl	103
Meas Method	104
Burst Width	104
Optimize Ref Level	106
Trace/View (Burst Power)	107
RF Envelope	107
Combined	108
Trace	108
Meas Setup (Complementary Cumulative Distribution Function—CCDF)	109
Meas BW	109
Counts	110
Meas Interval	111
Optimize Ref Level	112
Display (Complementary Cumulative Distribution Function—CCDF)	113
Full Screen	113
Store Ref Trace	113
Ref Trace	113
Gaussian Trace	114
Preferences	114
Marker (Complementary Cumulative Distribution Function—CCDF)	115
Select Marker	116
Normal	116
Delta	117
Off	117
Marker Trace	118
Marker All Off	118
Marker X Position (Remote Command Only)	119
Marker Y Position (Remote Command Only)	120
Marker Maximum and Minimum (Remote Command Only)	120
SPAN X Scale (Complementary Cumulative Distribution Function—CCDF)	121
Scale/Div	121
Meas Setup (Channel Power—CHP)	123
Avg Number	123
Avg Mode	124
Integ BW	124
Chan Pwr Span	125
PSD Unit (PSA Only Setting)	126
Optimize Ref Level	126
RRC Filter	126
Filter Alpha	128
Meas Setup (Harmonic Distortion)	129
Avg Number	129
Avg Mode	130
Harmonics	130
ST/Harmonic	131
Range Table (On/Off)	131

Range Table	132
Optimize Ref Level	138
Trace/View (Channel Power Measurement)	139
Spectrum	139
Combined	139
Trace	139
Trace/View (Harmonic Distortion)	141
Harmonics	141
Harmonics & THD	141
Meas Setup (Intermod (TOI))	143
Avg Number	143
Avg Mode	144
TOI Span	144
Max Mixer Lvl	145
Optimize Ref Level	146
Meas Setup (Multi-Carrier Power—MCP)	147
Avg Number	147
Avg Mode	148
Carrier Setup	149
Offsets/Limits	155
Carrier Result	158
Optimize Ref Level	158
Method	159
Power Ref	160
Limit Test	160
RRC Filter	161
Filter Alpha	161
Noise Correction	162
Trace/View (Multi-Carrier Power Measurement)	163
Spectrum	163
Combined	163
Combined View Units	164
Trace	164
Meas Setup (Occupied Bandwidth—OBW)	165
Avg Number	165
Avg Mode	166
Max Hold	166
Occ BW % Pwr	167
OBW Span	167
x dB	168
Optimize Ref Level	169
Meas Setup (Spectrum Emissions Mask—SEM)	171
Avg Number	171
Meas Type	172
Ref Channel	173
Offset/Limits	175
Results Index (PSA only)	187
Optimize Ref Level	187
RRC Filter	187

Contents

Filter Alpha	188
Display (Spectrum Emissions Mask—SEM)	189
Full Screen	189
Limit Display	189
Preferences	189
Marker (Spectrum Emissions Mask—SEM)	191
Select Marker	191
Normal	192
Off	192
Trace/View (Spectrum Emissions Mask)	193
Abs Pwr & Freq	193
Rel Pwr & Freq	193
Integrated Power	194
SPAN X Scale (Spectrum Emissions Mask—SEM)	195
Scale/Div.	195
Ref Value.	195
Ref Position.	196
Meas Setup (Spurious Emissions)	197
Avg Number	197
Avg Mode	197
Range Table	198
Meas Type	211
Spur	212
Ref Level	213
Fast Spurious Meas	213
Display (Spurious Emissions) for PSA Only	215
Full Screen	215
Preferences	215
Marker (Spurious Emissions) for PSA Only	217
Select Marker	217
Normal	218
Delta	218
Off	219
Markers All Off.	219
Marker Mode	220

3. Menu Maps:

One-Button Measurement Functions

One-Button Measurement Menu Maps	222
Directions for Use	223
MEASURE Key	224
Meas Control Key	225
Mode Setup Key for ESA	226
Mode Setup Key for PSA (1 of 3)	227
Mode Setup Key for PSA (2 of 3)	228
Mode Setup Key for PSA (3 of 3)	229
ACP Measurement: Meas Setup Key	230
ACP Measurement: Trace/View Key	231
Burst Power Measurement: Meas Setup Key	232

Burst Power Measurement: Trace/View Key	233
CCDF (Power Stat) Measurement: Meas Setup Key	234
CCDF (Power Stat) Measurement: Display Key	235
CCDF (Power Stat) Measurement: Marker Key	236
CCDF (Power Stat) Measurement: Span X Scale Key	237
CCDF (Power Stat) Measurement: Trace/View Key	238
Channel Power Measurement: Meas Setup Key	239
Channel Power Measurement: Trace/View Key	240
Harmonic Distortion Measurement: Meas Setup Key	241
Harmonic Distortion Measurement: Trace/View Key	242
Intermod (TOI): Meas Setup Key	243
Multi-Carrier Power Measurement: Meas Setup Key	244
Multi-Carrier Power Measurement: Trace/View Key	245
Occupied Bandwidth Measurement: Meas Setup Key	246
Spectrum Emission Mask Measurement: Meas Setup Key	247
Spectrum Emission Mask Measurement: Display Key	248
Spectrum Emission Mask Measurement: Marker Key	249
Spectrum Emission Mask Measurement: Span X Scale Key	250
Spectrum Emission Mask Measurement: Trace/View Key	251
Spurious Emissions Measurement: Meas Setup Key	252
Spurious Emissions Measurement: Meas Setup Key (2 of 2)	253
Spurious Emissions Measurement: Display	254
Spurious Emissions Measurement: Marker	255

Contents

List of Commands

:CALCulate:ACPower:OFFSet:LIST:LIMit:NEGative[:UPPer]:DATA <rel_power>,<rel_power>,<rel_power>,<rel_power>,<rel_power>,<rel_power>.....	89
:CALCulate:ACPower:OFFSet:LIST:LIMit:NEGative[:UPPer]:DATA?	89
:CALCulate:ACPower:OFFSet:LIST:LIMit:POSitive[:UPPer]:DATA <rel_power>,<rel_power>,<rel_power>,<rel_power>,<rel_power>,<rel_power>.....	89
:CALCulate:ACPower:OFFSet:LIST:LIMit:POSitive[:UPPer]:DATA?	89
:CALCulate:CLIMits:FAIL?	53
:CALCulate:MCPower:OFFSet:LIST:LIMit:NEGative[:UPPer]:DATA <dB>,<dB>,<dB>	158
:CALCulate:MCPower:OFFSet:LIST:LIMit:NEGative[:UPPer]:DATA?	158
:CALCulate:MCPower:OFFSet:LIST:LIMit:POSitive[:UPPer]:DATA <dB>,<dB>,<dB>	157
:CALCulate:MCPower:OFFSet:LIST:LIMit:POSitive[:UPPer]:DATA?	157
:CALCulate:PStatistic:MARKer[1] 2 3 4:MAXimum	120
:CALCulate:PStatistic:MARKer[1] 2 3 4:MINimum	120
:CALCulate:PStatistic:MARKer[1] 2 3 4:MODE NORMal DELTA OFF	115
:CALCulate:PStatistic:MARKer[1] 2 3 4:MODE?	115
:CALCulate:PStatistic:MARKer[1] 2 3 4:TRACe MEASured GAUSSian REFerence	118
:CALCulate:PStatistic:MARKer[1] 2 3 4:TRACe?	118
:CALCulate:PStatistic:MARKer[1] 2 3 4:X <dB>	119
:CALCulate:PStatistic:MARKer[1] 2 3 4:X:POSition <dB>	119
:CALCulate:PStatistic:MARKer[1] 2 3 4:X:POSition?	119
:CALCulate:PStatistic:MARKer[1] 2 3 4:X?	119
:CALCulate:PStatistic:MARKer[1] 2 3 4:Y?	120
:CALCulate:PStatistic:MARKer[1] 2 3 4[:STATe] OFF ON 0 1	116
:CALCulate:PStatistic:MARKer[1] 2 3 4[:STATe]?	116
:CALCulate:PStatistic:STORe:REFerence	113
:CALCulate:SEMAsk:MARKer[1] 2 3 4:STATe OFF ON 0 1	191
:CALCulate:SEMAsk:MARKer[1] 2 3 4:STATe?	191
:CALCulate:SPURious:MARKer[1] 2 3 4:STATe OFF ON 0 1	217
:CALCulate:SPURious:MARKer[1] 2 3 4:STATe?	217
:CALCulate:SPURious[:RANGe][:LIST]:LIMit:ABSolute[:UPPER]:DATA:STARt <integer>,<integer>,...	203
:CALCulate:SPURious[:RANGe][:LIST]:LIMit:ABSolute[:UPPER]:DATA:STARt?	203
:CALCulate:SPURious[:RANGe][:LIST]:LIMit:ABSolute[:UPPER]:DATA:STOP <integer>,<integer>,...	204

List of Commands

:CALCulate:SPURious[:RANGe][:LIST]:LIMit:ABSolute[:UPPER]:DATA:STOP:AUTO OFF ON 0 1, OFF ON 0 1	204
:CALCulate:SPURious[:RANGe][:LIST]:LIMit:ABSolute[:UPPER]:DATA:STOP?	204
:CONFigure:ACP	59
:CONFigure:BPOWer	72
:CONFigure:CHPower	56
:CONFigure:HARMonics	68
:CONFigure:MCP	62
:CONFigure:OBW	57
:CONFigure:PStatistic	66
:CONFigure:SANalyzer	54
:CONFigure:SEMAsk	75
:CONFigure:SPURious	74
:CONFigure:TOI	73
:CONFigure?	53
:DISPlay:PStatistic:GAUSSian[:STATe] OFF ON 0 1	114
:DISPlay:PStatistic:GAUSSian[:STATe]?	114
:DISPlay:PStatistic:RTRace[:STATe] OFF ON 0 1	113
:DISPlay:PStatistic:RTRace[:STATe]?	113
:DISPlay:PStatistic:XScale <rel_ampl>	121
:DISPlay:PStatistic:XScale?	121
:FETCh:ACP[n]?	59
:FETCh:BPOWer[n]?	72
:FETCh:CHPower:CHPower?	56
:FETCh:CHPower:DENSity?	56
:FETCh:CHPower?	56
:FETCh:HARMonics:AMPLitude:ALL?	68
:FETCh:HARMonics:AMPLitude[n]?	68
:FETCh:HARMonics:FREQuency:ALL?	68
:FETCh:HARMonics:FREQuency[n]?	69
:FETCh:HARMonics:FUNDamental?	69

:FETCh:HARMonics[:DISToRTion]?	68
:FETCh:HARMonics[n]?	69
:FETCh:MCPOwer[n]?	63
:FETCh:OBW:FERRor?	58
:FETCh:OBW:OBWidth?	57
:FETCh:OBW:XDB?	58
:FETCh:OBW?	57
:FETCh:PSStatistic[n]?	66
:FETCh:SEMAsk[n]?	76
:FETCh:SPURious[n]?	74
:FETCh:TOI:IP3?	73
:FETCh:TOI[n]?	73
:INITiate:ACP	59
:INITiate:BPOwer	72
:INITiate:CHPower	56
:INITiate:HARMonics	68
:INITiate:OBW	57
:INITiate:PSStatistic	66
:INITiate:SEMAsk	75
:INITiate:SPURious	74
:INITiate:TOI	73
:MEASure:ACP[n]?	59
:MEASure:BPOwer[n]?	72
:MEASure:CHPower:CHPower?	56
:MEASure:CHPower:DENSity?	56
:MEASure:CHPower?	56
:MEASure:HARMonics:AMPLitude:ALL?	68
:MEASure:HARMonics:AMPLitude[n]?	68
:MEASure:HARMonics:FREQuency:ALL?	68
:MEASure:HARMonics:FREQuency[n]?	69

List of Commands

:MEASure:HARMonics:FUNDamental?	69
:MEASure:HARMonics[:DISTortion]?	68
:MEASure:HARMonics[n]?	69
:MEASure:MCPower[n]?	63
:MEASure:OBW:FERRor?	58
:MEASure:OBW:OBWidth?	57
:MEASure:OBW:XDB?	58
:MEASure:OBW?	57
:MEASure:PStatistic[n]?	66
:MEASure:SEMask[n]?	76
:MEASure:SPURious[n]?	74
:MEASure:TOI:IP3?	73
:MEASure:TOI[n]?	73
:READ:ACP[n]?	59
:READ:BPower[n]?	72
:READ:CHPower:CHPower?	56
:READ:CHPower:DENSity?	56
:READ:CHPower?	56
:READ:HARMonics:AMPLitude:ALL?	68
:READ:HARMonics:AMPLitude[n]?	68
:READ:HARMonics:FREQuency:ALL?	68
:READ:HARMonics:FREQuency[n]?	69
:READ:HARMonics:FUNDamental?	69
:READ:HARMonics[:DISTortion]?	68
:READ:HARMonics[n]?	69
:READ:MCPower[n]?	63
:READ:OBW:FERRor?	58
:READ:OBW:OBWidth?	57
:READ:OBW:XDB?	58
:READ:OBW?	57

List of Commands

:READ:PSStatistic[n]?	66
:READ:SEMask[n]?	76
:READ:SPURious[n]?	74
:READ:TOI:IP3?	73
:READ:TOI[n]?	73
:UNIT:ACPower:POWer:PSD DBMHZ DBMMHZ	90
:UNIT:ACPower:POWer:PSD?	90
:UNIT:CHPower:POWer:PSD DBMHZ DBMMHZ	126
:UNIT:CHPower:POWer:PSD?	126
:UNIT:SEMask:POWer:PSD DBMHZ DBMMHZ	172
:UNIT:SEMask:POWer:PSD?	172
[[:SENSe]:ACPower:AVERAge:COUNt <integer>	83
[[:SENSe]:ACPower:AVERAge:COUNt?	83
[[:SENSe]:ACPower:AVERAge:TCONrol EXPonential REPeat	84
[[:SENSe]:ACPower:AVERAge:TCONrol?	84
[[:SENSe]:ACPower:AVERAge[:STATe] OFF ON 0 1	83
[[:SENSe]:ACPower:AVERAge[:STATe]?	83
[[:SENSe]:ACPower:BANDwidth BWIDth:INTegration <freq>	85
[[:SENSe]:ACPower:BANDwidth BWIDth:INTegration?	85
[[:SENSe]:ACPower:CARRier:AUTO[:STATe] OFF ON 0 1	95
[[:SENSe]:ACPower:CARRier:AUTO[:STATe]?	95
[[:SENSe]:ACPower:CARRier:CPSD <dBm>	95
[[:SENSe]:ACPower:CARRier:CPSD?	95
[[:SENSe]:ACPower:CARRier[:POWer] <ampl>	95
[[:SENSe]:ACPower:CARRier[:POWer]	95
[[:SENSe]:ACPower:CARRier[:POWer]?	95
[[:SENSe]:ACPower:CORRection:NOISe[:AUTO] OFF ON 0 1	98
[[:SENSe]:ACPower:CORRection:NOISe[:AUTO]?	98
[[:SENSe]:ACPower:FILTer[:RRC]:ALPHA <number>	97
[[:SENSe]:ACPower:FILTer[:RRC][:STATe] OFF ON 0 1	97
[[:SENSe]:ACPower:LIMit[:STATe] OFF ON 0 1	96

List of Commands

[[:SENSe]:ACPower:LIMit[:STATe]?).	96
[[:SENSe]:ACPower:METHod IBW RBW FAST	91
[[:SENSe]:ACPower:METHod?	91
[[:SENSe]:ACPower:OFFSet:LIST:BANDwidth BWIDth[:INTegration] <bw>,<bw>,<bw>,<bw>,<bw>,<bw>	88
[[:SENSe]:ACPower:OFFSet:LIST:BANDwidth BWIDth[:INTegration]?	88
[[:SENSe]:ACPower:OFFSet:LIST:STATE OFF ON 0 1, OFF ON 0 1, OFF ON 0 1, OFF ON 0 1, OFF ON 0 1, OFF ON 0 1.	86
[[:SENSe]:ACPower:OFFSet:LIST:STATE?	86
[[:SENSe]:ACPower:OFFSet:LIST[:FREQuency] <f_offset>,<f_offset>,<f_offset>,<f_offset>,<f_offset>,<f_offset>	86
[[:SENSe]:ACPower:OFFSet:LIST[:FREQuency]?	86
[[:SENSe]:ACPower:TYPE PSDRef TPRef	90
[[:SENSe]:ACPower:TYPE?	90
[[:SENSe]:BPOWer:AVERAge:COUNT <integer>	102
[[:SENSe]:BPOWer:AVERAge:COUNT?	102
[[:SENSe]:BPOWer:AVERAge:TCONrol EXPonential REPeat	102
[[:SENSe]:BPOWer:AVERAge:TCONrol?	102
[[:SENSe]:BPOWer:AVERAge:TYPe LPOWer POWer	103
[[:SENSe]:BPOWer:AVERAge:TYPe?	103
[[:SENSe]:BPOWer:AVERAge[:STATe] OFF ON 0 1	102
[[:SENSe]:BPOWer:AVERAge[:STATe]?	102
[[:SENSe]:BPOWer:BURSt:AUTO OFF ON 0 1	105
[[:SENSe]:BPOWer:BURSt:AUTO?	105
[[:SENSe]:BPOWer:BURSt:WIDTh	105
[[:SENSe]:BPOWer:BURSt:WIDTh?	105
[[:SENSe]:BPOWer:METHod THReshold BWIDth	104
[[:SENSe]:BPOWer:METHod?	104
[[:SENSe]:BPOWer:THReshold <number>	104
[[:SENSe]:BPOWer:THReshold:TYPe ABSolute RELative	104
[[:SENSe]:BPOWer:THReshold:TYPe?	104
[[:SENSe]:BPOWer:THReshold?	104

[[:SENSe]:CHPower:AVERage:COUNT <integer>	123
[[:SENSe]:CHPower:AVERage:COUNT?	123
[[:SENSe]:CHPower:AVERage:TCONrol EXPonential REPeat	124
[[:SENSe]:CHPower:AVERage:TCONrol?	124
[[:SENSe]:CHPower:AVERage[:STATe] OFF ON 0 1	123
[[:SENSe]:CHPower:AVERage[:STATe]?	123
[[:SENSe]:CHPower:BANDwidth BWIDth:INTegration <freq>	125
[[:SENSe]:CHPower:BANDwidth BWIDth:INTegration?	125
[[:SENSe]:CHPower:FILTer[:RRC]:ALPHA <number>	128
[[:SENSe]:CHPower:FILTer[:RRC]:ALPHA?	128
[[:SENSe]:CHPower:FILTer[:RRC][:STATe] OFF ON 0 1	127
[[:SENSe]:CHPower:FILTer[:RRC][:STATe]?	127
[[:SENSe]:CHPower:FREQuency:SPAN <freq>	125
[[:SENSe]:CHPower:FREQuency:SPAN?	125
[[:SENSe]:HARMonics:AVERage:COUNT <integer>	129
[[:SENSe]:HARMonics:AVERage:COUNT?	129
[[:SENSe]:HARMonics:AVERage:TCONrol EXPonential REPeat	130
[[:SENSe]:HARMonics:AVERage:TCONrol?	130
[[:SENSe]:HARMonics:AVERage[:STATe] OFF ON 0 1	129
[[:SENSe]:HARMonics:AVERage[:STATe]?	129
[[:SENSe]:HARMonics:NUMBer <integer>	130
[[:SENSe]:HARMonics:NUMBer?	130
[[:SENSe]:HARMonics:RANGe[:LIST]:BWIDth BANDwidth:VIDeo	136
[[:SENSe]:HARMonics:RANGe[:LIST]:BWIDth BANDwidth:VIDeo:AUTO OFF ON 0 1	136
[[:SENSe]:HARMonics:RANGe[:LIST]:BWIDth BANDwidth:VIDeo:AUTO?	136
[[:SENSe]:HARMonics:RANGe[:LIST]:BWIDth BANDwidth:VIDeo?	136
[[:SENSe]:HARMonics:RANGe[:LIST]:BWIDth BANDwidth[:RESolution]:AUTO OFF ON 0 1	135
[[:SENSe]:HARMonics:RANGe[:LIST]:BWIDth BANDwidth[:RESolution]:AUTO?	135
[[:SENSe]:HARMonics:RANGe[:LIST]:BWIDth BANDwidth[:RESolution]?	135
[[:SENSe]:HARMonics:RANGe[:LIST]:BWIDth BANDwidth[:RESolution]<integer>	135
[[:SENSe]:HARMonics:RANGe[:LIST]:FREQuency <integer>	134

List of Commands

[[:SENSe]:HARMonics:RANGe[:LIST]:FREQuency?	134
[[:SENSe]:HARMonics:RANGe[:LIST]:SPAN	135
[[:SENSe]:HARMonics:RANGe[:LIST]:SPAN?	135
[[:SENSe]:HARMonics:RANGe[:LIST]:STATe OFF ON 0 1	133
[[:SENSe]:HARMonics:RANGe[:LIST]:STATe?	133
[[:SENSe]:HARMonics:RANGe[:LIST]:SWEep:TIME: <integer>	137
[[:SENSe]:HARMonics:RANGe[:LIST]:SWEep:TIME:AUTO OFF ON 0 1	137
[[:SENSe]:HARMonics:RANGe[:LIST]:SWEep:TIME:AUTO?	137
[[:SENSe]:HARMonics:RANGe[:LIST]:SWEep:TIME?	137
[[:SENSe]:HARMonics:RTABle:FILL <no query>	137
[[:SENSe]:HARMonics:RTABle:STATe OFF ON 0 1	131
[[:SENSe]:HARMonics:RTABle:STATe?	131
[[:SENSe]:HARMonics:SWEeptime <time>	131
[[:SENSe]:HARMonics:SWEeptime:STATe OFF ON 0 1	131
[[:SENSe]:HARMonics:SWEeptime:STATe?	131
[[:SENSe]:HARMonics:SWEeptime?	131
[[:SENSe]:MCPower:AVERage:COUNT <integer>	148
[[:SENSe]:MCPower:AVERage:COUNT?	148
[[:SENSe]:MCPower:AVERage:TCONrol EXPonential REPeat	148
[[:SENSe]:MCPower:AVERage:TCONrol?	148
[[:SENSe]:MCPower:AVERage[:STATe] OFF ON 0 1	148
[[:SENSe]:MCPower:AVERage[:STATe]?	148
[[:SENSe]:MCPower:CARRier:AUTO[:STATe] OFF ON 0 1	160
[[:SENSe]:MCPower:CARRier:AUTO[:STATe]?	160
[[:SENSe]:MCPower:CARRier:COUNT?	149
[[:SENSe]:MCPower:CARRier:COUNT<integer>	149
[[:SENSe]:MCPower:CARRier:LIST:BANDwidth BWIDth[:INTegration]?	155
[[:SENSe]:MCPower:CARRier:LIST:BANDwidth BWIDth[:INTegration]<Hz>	155
[[:SENSe]:MCPower:CARRier:LIST:PPResent YES NO	153
[[:SENSe]:MCPower:CARRier:LIST:PPResent?	153
[[:SENSe]:MCPower:CARRier:LIST:WIDTh <Hz>	154

List of Commands

[[:SENSe]:MCPower:CARRier:LIST:WIDTh?	154
[[:SENSe]:MCPower:CARRier[:POWer]?	160
[[:SENSe]:MCPower:CARRier[:POWer]<dBm>	160
[[:SENSe]:MCPower:CORRection:NOISe[:AUTO] OFF ON 0 1	162
[[:SENSe]:MCPower:CORRection:NOISe[:AUTO]?	162
[[:SENSe]:MCPower:FILTer[:RRC]:ALPHA <number>	162
[[:SENSe]:MCPower:FILTer[:RRC]:ALPHA?	162
[[:SENSe]:MCPower:FILTer[:RRC][:STATe] OFF ON 0 1	161
[[:SENSe]:MCPower:LIMit[:STATe] OFF ON 0 1	161
[[:SENSe]:MCPower:LIMit[:STATe]?	161
[[:SENSe]:MCPower:METHod IBW RBW	159
[[:SENSe]:MCPower:METHod?	159
[[:SENSe]:MCPower:OFFSet:LIST:[FREQuency]?	156
[[:SENSe]:MCPower:OFFSet:LIST:[FREQuency]<Hz>,<Hz>,<Hz>	156
[[:SENSe]:MCPower:OFFSet:LIST:BANDwidth BWIDTh:[INTeGration]<Hz>,<Hz>,<Hz>	157
[[:SENSe]:MCPower:RCARrier:AUTO OFF ON 0 1	150
[[:SENSe]:MCPower:RCARrier:AUTO?	150
[[:SENSe]:MCPower:RCARrier?	150
[[:SENSe]:MCPower:RCARrier<integer>	150
[[:SENSe]:MCPower:RCFRrequency:AUTO OFF ON 0 1	151
[[:SENSe]:MCPower:RCFRrequency:AUTO?	151
[[:SENSe]:MCPower:RCFRrequency?	151
[[:SENSe]:MCPower:RCFRrequency<Freq>	151
[[:SENSe]:OBW:AVERAge:TCONtrol EXPOntial REPeat	166
[[:SENSe]:OBW:AVERAge:TCONtrol?	166
[[:SENSe]:OBW:FREQuency:SPAN <freq>	167
[[:SENSe]:OBW:FREQuency:SPAN?	167
[[:SENSe]:OBW:MAXHold OFF ON 0 1	166
[[:SENSe]:OBW:MAXHold?	166
[[:SENSe]:OBW:XDB <dB value>	169
[[:SENSe]:OBW:XDB?	169

List of Commands

[[:SENSe]:OBWidth:AVERage:COUNT <integer>	165
[[:SENSe]:OBWidth:AVERage:COUNT?	165
[[:SENSe]:OBWidth:AVERage[:STATe] OFF ON 0 1	165
[[:SENSe]:OBWidth:AVERage[:STATe]?	165
[[:SENSe]:OBWidth:PERCent <percent>	167
[[:SENSe]:OBWidth:PERCent?	167
[[:SENSe]:POWer[:RF]:RANGe:AUTO ONCE	112
[[:SENSe]:POWer[:RF]:RANGe:AUTO ONCE?	90
[[:SENSe]:PSTatistic:BANDwidth BWIDth <freq>	110
[[:SENSe]:PSTatistic:BANDwidth BWIDth?	110
[[:SENSe]:PSTatistic:COUNTs <integer>	110
[[:SENSe]:PSTatistic:COUNTs?	110
[[:SENSe]:PSTatistic:SWEep:TIME <time>	111
[[:SENSe]:PSTatistic:SWEep:TIME?	111
[[:SENSe]:RADio:STANdard:BAND:CLASs BC0 BC1	47
[[:SENSe]:RADio:STANdard:BAND:CLASs?	47
[[:SENSe]:RADio:STANdard:DEVice BTS MS	46
[[:SENSe]:RADio:STANdard:DEVice?	46
[[:SENSe]:RADio:STANdard:EAMeas	48
[[:SENSe]:RADio:STANdard:EAMeas?	48
[[:SENSe]:RADio:STANdard:PACKet DH1 DH3 DH5	46
[[:SENSe]:RADio:STANdard:PACKet?	46
[[:SENSe]:RADio:STANdard:RPARams[:STATe]?	47
[[:SENSe]:RADio:STANdard:RPARams[:STATe]ON Off 1 0	47
[[:SENSe]:RADio:STANdard:SBWidth <freq>	45
[[:SENSe]:RADio:STANdard:SBWidth?	45
[[:SENSe]:RADio:STANdard[:SElect]?	33
[[:SENSe]:SEMAsk:AVERage:COUNT <integer>	171
[[:SENSe]:SEMAsk:AVERage:COUNT?	171
[[:SENSe]:SEMAsk:AVERage[:STATe] OFF ON 0 1	171
[[:SENSe]:SEMAsk:AVERage[:STATe]?	171

[::SENSe]:SEMAsk:BANDwidth[n]BWIDth[n]:INTEgration <number>	173
[::SENSe]:SEMAsk:BANDwidth[n]BWIDth[n]:INTEgration?	173
[::SENSe]:SEMAsk:BANDwidth BWIDth[:RESolution] <freq>	174
[::SENSe]:SEMAsk:BANDwidth BWIDth[:RESolution]:AUTO OFF ON 0 1	174
[::SENSe]:SEMAsk:BANDwidth BWIDth[:RESolution]:AUTO?	174
[::SENSe]:SEMAsk:BANDwidth BWIDth[:RESolution]?	174
[::SENSe]:SEMAsk:CARRier:AUTO[:STATe] OFF ON 0 1	175
[::SENSe]:SEMAsk:CARRier:AUTO[:STATe]?	175
[::SENSe]:SEMAsk:CARRier[:POWER] <ampl>	175
[::SENSe]:SEMAsk:CARRier[:POWER]?	175
[::SENSe]:SEMAsk:FILTer[:RRC]:ALPHA <number>	188
[::SENSe]:SEMAsk:FILTer[:RRC]:ALPHA?	188
[::SENSe]:SEMAsk:FILTer[:RRC][:STATe] OFF ON 0 1	188
[::SENSe]:SEMAsk:FILTer[:RRC][:STATe]?	188
[::SENSe]:SEMAsk:FREQuency:SPAN <number>	173
[::SENSe]:SEMAsk:FREQuency:SPAN?	173
[::SENSe]:SEMAsk:OFFSet[n]:LIST:BANDwidth BWIDth:IMULti <integer>	182
[::SENSe]:SEMAsk:OFFSet[n]:LIST:BANDwidth BWIDth:IMULti?	182
[::SENSe]:SEMAsk:OFFSet[n]:LIST:BANDwidth BWIDth[:RESolution] <freq>... [<freq>] (up to five values) ..	180
[::SENSe]:SEMAsk:OFFSet[n]:LIST:BANDwidth BWIDth[:RESolution]:AUTO OFF ON 0 1	180
[::SENSe]:SEMAsk:OFFSet[n]:LIST:BANDwidth BWIDth[:RESolution]:AUTO?	180
[::SENSe]:SEMAsk:OFFSet[n]:LIST:BANDwidth BWIDth[:RESolution]:AUTO OFF ON 0 1	182
[::SENSe]:SEMAsk:OFFSet[n]:LIST:BANDwidth BWIDth[:RESolution]?	180
[::SENSe]:SEMAsk:OFFSet[n]:LIST:FREQuency:STARt <freq>,... [<freq>]	178
[::SENSe]:SEMAsk:OFFSet[n]:LIST:FREQuency:STARt?	178
[::SENSe]:SEMAsk:OFFSet[n]:LIST:FREQuency:STOP <freq>... [<freq>]	179
[::SENSe]:SEMAsk:OFFSet[n]:LIST:FREQuency:STOP?	179
[::SENSe]:SEMAsk:OFFSet[n]:LIST:STARt:ABSolute <ampl>,... [<ampl>] (up to five values)	182
[::SENSe]:SEMAsk:OFFSet[n]:LIST:STARt:ABSolute?	183
[::SENSe]:SEMAsk:OFFSet[n]:LIST:STARt:RCARRier <rel_ampl>,... [<rel_ampl>] (up to five values)	184

List of Commands

[[:SENSe]:SEMAsk:OFFSet[n]:LIST:STARt:RCARrier?	184
[[:SENSe]:SEMAsk:OFFSet[n]:LIST:STATe OFF ON 0 	178
[[:SENSe]:SEMAsk:OFFSet[n]:LIST:STATe?	178
[[:SENSe]:SEMAsk:OFFSet[n]:LIST:STOP:ABSolute <ampl>,...[<ampl>] (up to five values)	183
[[:SENSe]:SEMAsk:OFFSet[n]:LIST:STOP:ABSolute:COUPlE OFF ON 0 1	183
[[:SENSe]:SEMAsk:OFFSet[n]:LIST:STOP:ABSolute:COUPlE?	183
[[:SENSe]:SEMAsk:OFFSet[n]:LIST:STOP:ABSolute?.	183
[[:SENSe]:SEMAsk:OFFSet[n]:LIST:STOP:RCARrier <real number>,[<real number>]....	184
[[:SENSe]:SEMAsk:OFFSet[n]:LIST:STOP:RCARrier:COUPlE OFF ON 0 1	184
[[:SENSe]:SEMAsk:OFFSet[n]:LIST:STOP:RCARrier:COUPlE?	184
[[:SENSe]:SEMAsk:OFFSet[n]:LIST:STOP:RCARrier?	184
[[:SENSe]:SEMAsk:OFFSet[n]:LIST:SWEEptime <time>... [<time>]	180
[[:SENSe]:SEMAsk:OFFSet[n]:LIST:SWEEptime:AUTO OFF ON 0 1	180
[[:SENSe]:SEMAsk:OFFSet[n]:LIST:SWEEptime:AUTO?	180
[[:SENSe]:SEMAsk:OFFSet[n]:LIST:SWEEptime?	180
[[:SENSe]:SEMAsk:OFFSet[n]:LIST:TEST ABSolute AND OR RELative,ABSolute AND OR RELative,ABSolute AND OR RELative,ABSolute AND OR RELative	185
[[:SENSe]:SEMAsk:OFFSet[n]:LIST:TEST?	185
[[:SENSe]:SEMAsk:RESult	187
[[:SENSe]:SEMAsk:SWEEptime <number>	174
[[:SENSe]:SEMAsk:SWEEptime:AUTO OFF ON 0 1	174
[[:SENSe]:SEMAsk:SWEEptime:AUTO?	174
[[:SENSe]:SEMAsk:SWEEptime?	174
[[:SENSE]:SEMAsk:TYPE TPref PSDRef	172
[[:SENSE]:SEMAsk:TYPE?	172
[[:SENSe]:SPURious:AVERage:COUNT <integer>	197
[[:SENSe]:SPURious:AVERage:COUNT?	197
[[:SENSe]:SPURious:AVERage:TCONrol EXponential REPeat	198
[[:SENSe]:SPURious:AVERage:TCONrol?	198
[[:SENSe]:SPURious:AVERage[:STATe] OFF ON 0 1	197
[[:SENSe]:SPURious:AVERage[:STATe]?	197

[[:SENSe]:SPURious:FSMeas OFF ON 0 1	214
[[:SENSe]:SPURious:FSMeas?	214
[[:SENSe]:SPURious:POWer[:RF]:LEVel <integer>	213
[[:SENSe]:SPURious:POWer[:RF]:LEVel?	213
[[:SENSe]:SPURious:POWer[:RF]:RANGe:AUTO OFF ON 0 1	213
[[:SENSe]:SPURious:POWer[:RF]:RANGe:AUTO?	213
[[:SENSe]:SPURious:SPUR	213
[[:SENSe]:SPURious:SPUR?	213
[[:SENSe]:SPURious:TYPE EXAMine FULL	212
[[:SENSe]:SPURious:TYPE?	212
[[:SENSe]:SPURious[:RANGe][:LIST]:ATTenuation	205
[[:SENSe]:SPURious[:RANGe][:LIST]:ATTenuation?	206
[[:SENSe]:SPURious[:RANGe][:LIST]:BANDwidth[:RESolution] <freq>, <freq>,...	201
[[:SENSe]:SPURious[:RANGe][:LIST]:BANDwidth[:RESolution]:AUTO OFF ON 0 1	201
[[:SENSe]:SPURious[:RANGe][:LIST]:BANDwidth[:RESolution]:AUTO?	201
[[:SENSe]:SPURious[:RANGe][:LIST]:BANDwidth[:RESolution]?	201
[[:SENSe]:SPURious[:RANGe][:LIST]:BWIDth BANDwidth:VIDeo	202
[[:SENSe]:SPURious[:RANGe][:LIST]:BWIDth BANDwidth:VIDeo:AUTO OFF ON 0 1	202
[[:SENSe]:SPURious[:RANGe][:LIST]:BWIDth BANDwidth:VIDeo:AUTO?	202
[[:SENSe]:SPURious[:RANGe][:LIST]:BWIDth BANDwidth:VIDeo?	202
[[:SENSe]:SPURious[:RANGe][:LIST]:DET?	206
[[:SENSe]:SPURious[:RANGe][:LIST]:FREQuency:STARt <freq>, <freq>,...	200
[[:SENSe]:SPURious[:RANGe][:LIST]:FREQuency:STARt?	200
[[:SENSe]:SPURious[:RANGe][:LIST]:FREQuency:STOP <freq>, <freq>...	201
[[:SENSe]:SPURious[:RANGe][:LIST]:FREQuency:STOP?	201
[[:SENSe]:SPURious[:RANGe][:LIST]:PEAK:EXCursion	204
[[:SENSe]:SPURious[:RANGe][:LIST]:PEAK:EXCursion?	205
[[:SENSe]:SPURious[:RANGe][:LIST]:PEAK:THReshold	205
[[:SENSe]:SPURious[:RANGe][:LIST]:PEAK:THReshold?	205
[[:SENSe]:SPURious[:RANGe][:LIST]:POINts[:FUNction] NORMal AVERage POSitive SAMPlE NEGa- tive QPEak EAVERage EPOSitive MPositive	206

List of Commands

[[:SENSe]:SPURious[:RANGe][:LIST]:POINts[:FUNcTION] OFF NORMal AVERAge POSitive SAMPle NEGative QPEak EAverage EPOSitive MPositive	207
[[:SENSe]:SPURious[:RANGe][:LIST]:STATe OFF ON 0 1	200
[[:SENSe]:SPURious[:RANGe][:LIST]:STATe?	200
[[:SENSe]:SPURious[:RANGe][:LIST]:SWEep:POINts	211
[[:SENSe]:SPURious[:RANGe][:LIST]:SWEep:POINts:AUTO	211
[[:SENSe]:SPURious[:RANGe][:LIST]:SWEep:POINts:AUTO?	211
[[:SENSe]:SPURious[:RANGe][:LIST]:SWEep:POINts?	211
[[:SENSe]:SPURious[:RANGe][:LIST]:SWEep:TIME: <time>, <time>,	202
[[:SENSe]:SPURious[:RANGe][:LIST]:SWEep:TIME:AUTO OFF ON 0 1, OFF ON 0 1	202
[[:SENSe]:SPURious[:RANGe][:LIST]:SWEep:TIME:AUTO?	202
[[:SENSe]:SPURious[:RANGe][:LIST]:SWEep:TIME?	202
[[:SENSe]:TOIN:AVERAge:COUNT <integer>.	143
[[:SENSe]:TOIN:AVERAge:COUNT?	143
[[:SENSe]:TOIN:AVERAge:TCONrol EXPonential REPeat	144
[[:SENSe]:TOIN:AVERAge:TCONrol?	144
[[:SENSe]:TOIN:AVERAge[:STATe] OFF ON 0 1	143
[[:SENSe]:TOIN:AVERAge[:STATe]?	143
[[:SENSe]:TOIN:FREQuency:MIXer:RANGe:AUTO OFF ON 0 1	145
[[:SENSe]:TOIN:FREQuency:MIXer:RANGe:AUTO?	145
[[:SENSe]:TOIN:FREQuency:MIXer:RANGe[:UPPer] <number>.	145
[[:SENSe]:TOIN:FREQuency:MIXer:RANGe[:UPPer]?	145
[[:SENSe]:TOIN:FREQuency:SPAN <number>	145
[[:SENSe]:TOIN:FREQuency:SPAN?	145
For ESA only:	
[[:SENSe]:RADio:STANdard[:SElect] NONE IS95a JSTD IS95C GSM W3GPP C2000MC1 C2000DS C2000MC3 NADC PDC BLUEtooth TETRa WL802DOT11A WL802DOT11B WL802DOT11G HIPERLAN2 DVBTLN DVB TGPN DVB TIPN 	33
For PSA only:	
[[:SENSe]:RADio:STANdard[:SElect] NONE IS95a JSTD IS95C GSM W3GPP C2000MC1 C2000DS C2000MC3 NADC PDC BLUEtooth TETRa WL802DOT11A WL802DOT11B WL802DOT11G WL802DOT11N HIPERLAN2 DVBTDL N DVB TGPN DVB TIPN FCC15 SDMBSE UWBINDOOR 	33

List of Commands

UNIT:ACP:POW:PSD DBMMHZ.....	90
UNIT:CHP:POW:PSD DBMMHZ.....	126
UNIT:SEM:POW:PSD DBMMHZ.....	172

1 Using This Document

This book, Volume 2, provides the user and programming information for the one-button power measurement functions. For the core spectrum analyzer functionality refer to Volume 1, *Core Spectrum Analyzer Functions User's and Programmer's Reference*.

About the User's and Programmer's Information

Your user's and programmer's information is organized in two volumes, Volume 1, *Core Spectrum Analyzer Functions User's and Programmer's Reference* and Volume 2, *One-Button Power Measurements User's and Programmer's Reference*.

This document is Volume 2 and provides user and programmer information for the one-button power measurement functions only. For information about the core spectrum analyzer functionality and programming fundamentals refer to Volume 1, *Core Spectrum Analyzer Functions User's and Programmer's Reference*.

NOTE The front- and rear-panel features, along with the numeric keypad and alpha-numeric softkey fundamentals are illustrated and described, in your Getting Started guide.

What is in This Book

- **Using This Document**- describes the organization of this book.
- **One-Button Measurement Functions** - provides key descriptions and programming information for each key associated with the measurements available when you press the front-panel **MEASURE** key.

NOTE The core spectrum analyzer functions and programming information is provided in its own manual; if you are unable to locate the information you need in this book, try Volume 1, *Core Spectrum Analyzer Functions User's and Programmer's Reference*.

- **Menu Maps** - illustrate the menu structure of the front-panel and lower-level keys associated with the one-button measurements. Refer to this chapter to identify the lower-level softkeys associated with the front-panel keys.

Terms Used in This Book

There are many terms used throughout this book, for example “active function block,” that are explained in detail in the Getting Started guide. It is recommended that you read the Getting Started guide first.

The following terms are used to describe each key. Note that a key description may not use all the terms.

State Saved: Indicates what happens to a particular function when the instrument state is saved (either to floppy disk or the internal c:\ drive). It also indicates whether the current settings of the function are maintained if the instrument is powered on or preset using **Power On Last State** or **User Preset**.

**Dependencies/
Couplings:** Describes dependencies or interactions to other functions or settings in the analyzer.

Factory Preset: Describes the function settings after a **Factory Preset**.

Default

Terminator: Indicates the units that will be attached to the numerical value that you have entered. This default will be used from the front panel, when you terminate your entry by pressing the **Enter** key, rather than selecting a units key. This default will be used remotely when you send the command without specifying any units after your value(s).

Range: Describes the range of the smallest to largest values to which the function can be set. If you try to set a value below the minimum value, the analyzer defaults to the minimum value. If you try to set a value above the maximum value, the analyzer defaults to the maximum value.

History: Describes the firmware revision history. *Only applies after first firmware release.*

**Remote
Command:** Shows the syntax requirements for each SCPI command.

Example: Provides command examples using the indicated remote command syntax.

Using This Document
About the User's and Programmer's Information

2 One-Button Measurement Functions

This chapter provides you with functional descriptions, and remote programming commands for all measurements available to you when you press the front-panel **MEASURE** key (Spectrum Analysis mode is selected).

One - Button Measurement Functions

This section provides key descriptions and programming information for each key associated with the measurements available when you press the front-panel **MEASURE** key. The information for keys common to all measurements (**MEASURE**, **Meas Control**, and **Mode Setup**) is presented first and the information unique to each measurement is grouped by measurement type. Use the table below to locate the key descriptions and remote commands for the measurement of interest.

Key Function	Page Location
MEASURE	page 49
Mode Setup	page 33
ACP Measurement	
Meas Setup	page 83
Trace/View	page 99
Burst Power Measurement	
Meas Setup	page 101
Trace/View	page 107
CCDF Measurement (Power Stat)	
Meas Setup	page 109
Display	page 113
Span X Scale	page 121
Marker	page 115
Channel Power Measurement	
Meas Setup	page 123
Trace/View	page 139
Harmonic Distortion Measurement	
Meas Setup	page 129
Trace/View	page 141
Intermod (TOI) Measurement	
Meas Setup	page 143
Multi-Carrier Power Measurement	
Meas Setup	page 147
Trace/View	page 163

Key Function	Page Location
Occupied BW Measurement	
Meas Setup	page 165
Spectrum Emission Mask Measurement	
Meas Setup	page 171
Trace/View	page 193
Display	page 189
Span X Scale	page 195
Marker	page 191
Spurious Emissions Measurement	
Meas Setup	page 197

One-Button Measurement Functions
One - Button Measurement Functions

2.1 Mode Setup (Spectrum Analysis Mode)

Enables you to change measurement settings common to *all* measurements in the **MEASURE** menu. In Spectrum Analysis mode, there are several built-in power measurements. Parameters that you set in the Mode Setup menu affect all of these measurements.

Key Path: Front-panel key

2.1.1 Radio Std

Accesses the available radio standards. Selecting a radio standard modifies spectrum analyzer settings for the measurements activated under the **MEASURE** menu.

Measurements that are not relevant to the selected radio standard are not available (grayed out) and they do not have instrument default settings associated with them. If **Enable All Measurements** is set to *Yes* when the **Radio Std** is pressed, only the standards that are relevant to the currently active measurement will be available. Unavailable standards are grayed out.

Key Path: **Mode Setup**

Factory Preset: None

History: Updated with PSA firmware revision A.06.00
 Updated with PSA firmware revision A.04.00
 Added with PSA firmware revision A.02.00
 Modified with ESA firmware revision A.08.00
 Added with ESA firmware revision A.07.00

Remote Command:

For PSA only:

```
[ :SENSe] :RADio:STANdard[ :SELEct]
NONE | IS95a | JSTD | IS95C | GSM | W3GPP | C2000MC1 | C2000DS | C2000MC3 | NADC | PDC |
BLUETooth | TETRA | WL802DOT11A | WL802DOT11B | WL802DOT11G | WL802DOT11N | HIPERLAN2 |
DVBTDLN | DVBTGPN | DVBTIPN | FCC15 | SDMBSE | UWBINDOOR |
```

For ESA only:

```
[ :SENSe] :RADio:STANdard[ :SELEct]
NONE | IS95a | JSTD | IS95C | GSM | W3GPP | C2000MC1 | C2000DS | C2000MC3 | NADC | PDC |
BLUETooth | TETRA | WL802DOT11A | WL802DOT11B | WL802DOT11G | HIPERLAN2 | DVBTLSN
DVBTGPN | DVBTIPN |
```

```
[ :SENSe] :RADio:STANdard[ :SELEct] ?
```

One-Button Measurement Functions Mode Setup (Spectrum Analysis Mode)

2.1.1.1 None

Selects no radio standard. If **Radio Std, None** is selected when a measurement is running, all measurement parameters are returned to their default values. Analyzer parameters outside the **MEASURE** or **Meas Setup** key menus are not affected.

Key Type: 1 of N menu
Key Path: **Mode Setup, Radio Std**
History: Modified with PSA firmware revision A.04.00
Added with PSA firmware revision A.02.00
Modified with ESA firmware revision A.08.00
Added with ESA firmware revision A.07.00

Remote Command:

Use [:SENSe]:RADio:STANdard[:SElect] See “Radio Std” on page 33.

Example: RAD:STAN NONE

2.1.1.2 IS-95A

Sets the specific parameters for the selected measurement (located under the “MEASURE (Spectrum Analysis Mode)” key description) appropriate for industry standard IS-95A. The Spectrum Emissions Mask, Harmonic Distortion, and Spurious Emissions measurements are not available when this radio standard is selected.

Key Type: 1 of N menu
Key Path: **Mode Setup, Radio Std**
History: Modified with PSA firmware revision A.04.00
Added with PSA firmware revision A.02.00
Modified with ESA firmware revision A.08.00
Added with ESA firmware revision A.07.00

Remote Command:

Use [:SENSe]:RADio:STANdard[:SElect] See “Radio Std” on page 33.

Example: RAD:STAN IS95

2.1.1.3 J-STD-008

Sets the specific parameters for the selected measurement (located under the “MEASURE (Spectrum Analysis Mode)” key description) appropriate for industry standard J-STD-008. The Spectrum Emissions Mask, Harmonic Distortion, MCP, and Spurious Emissions measurements are not available when this radio standard is selected.

Key Type: 1 of N menu
Key Path: **Mode Setup, Radio Std**
History: Modified with PSA firmware revision A.04.00
Added with PSA firmware revision A.02.00
Modified with ESA firmware revision A.08.00
Added with ESA firmware revision A.07.00

Remote Command:

Use [:SENSE]:RADio:STANdard[:SELEct] See “Radio Std” on page 33.

Example: RAD:STAN JSTD

2.1.1.4 IS-95C

Sets the specific parameters for the selected measurement (located under the “MEASURE (Spectrum Analysis Mode)” key description) appropriate for industry standard IS-95C. The IS-95C radio standard is only available when selecting the Channel Power, Occupied Bandwidth, Adjacent Channel Power, and CCDF one-button measurements.

Key Type: 1 of N menu
Key Path: **Mode Setup, Radio Std**
History: Modified with PSA firmware revision A.04.00
Added with PSA firmware revision A.02.00
Modified with ESA firmware revision A.10.00
Added with ESA firmware revision A.07.00

Remote Command:

Use [:SENSE]:RADio:STANdard[:SELEct] See “Radio Std” on page 33.

Example: RAD:STAN IS95C

2.1.1.5 GSM/EDGE

Sets the specific parameters for the selected measurement (located under the “MEASURE (Spectrum Analysis Mode)” key description) appropriate for industry standard GSM/EDGE. Power Stat CCDF and Burst Power are the only measurements available for this standard.

Key Type: 1 of N menu
Key Path: **Mode Setup, Radio Std**
History: Modified with PSA firmware revision A.04.00
Added with PSA firmware revision A.02.00
Modified with ESA firmware revision A.08.00
Added with ESA firmware revision A.07.00

Remote Command:

Use [:SENSe]:RADio:STANdard[:SElect] See “Radio Std” on page 33.

Example: RAD:STAN GSM

2.1.1.6 3GPP W-CDMA

Sets the specific parameters for the selected measurement (located under the “MEASURE (Spectrum Analysis Mode)” key description) appropriate for industry standard W-CDMA. All measurements except Harmonic Distortion and Spurious Emissions are available for this standard.

Key Type: 1 of N menu
Key Path: **Mode Setup, Radio Std**
History: Modified with PSA firmware revision A.04.00
Added with PSA firmware revision A.02.00
Modified with ESA firmware revision A.08.00
Added with ESA firmware revision A.07.00

Remote Command:

Use [:SENSe]:RADio:STANdard[:SElect] See “Radio Std” on page 33.

Example: RAD:STAN W3GPP

2.1.1.7 cdma2000 MC-1X

Sets the specific parameters for the selected measurement (located under the “MEASURE (Spectrum Analysis Mode)” key description) appropriate for industry standard cdma2000-MC-1X. All measurements except Harmonic Distortion, Spurious Emissions, and Spectrum Emission Mask are available for this standard.

Key Type: 1 of N menu
Key Path: **Mode Setup, Radio Std**
History: Modified with PSA firmware revision A.04.00
Added with PSA firmware revision A.02.00
Modified with ESA firmware revision A.08.00
Added with ESA firmware revision A.07.00

Remote Command:

Use [:SENSE]:RADio:STANdard[:SELEct] See “Radio Std” on page 33.

Example: RAD:STAN C2000MC1

2.1.1.8 cdma2000 MC-3X

Sets the specific parameters for the selected measurement (located under the “MEASURE (Spectrum Analysis Mode)” key description) appropriate for industry standard cdma2000:MC-3X. All measurements except Multi-Carrier Power, Harmonic Distortion, Spurious Emissions and Spectrum Emission Mask are available for this standard.

Key Type: 1 of N menu
Key Path: **Mode Setup, Radio Std**
History: Modified with PSA firmware revision A.04.00
Added with PSA firmware revision A.02.00
Modified with ESA firmware revision A.08.00
Added with ESA firmware revision A.07.00

Remote Command:

Use [:SENSE]:RADio:STANdard[:SELEct] See “Radio Std” on page 33.

Example: RAD:STAN C2000MC3

2.1.1.9 cdma2000 DS

Sets the specific parameters for the selected measurement (located under the “MEASURE (Spectrum Analysis Mode)” key description) appropriate for industry standard cdma2000:DS. All measurements except Multi-Carrier Power, Harmonic Distortion, Spurious Emissions and Spectrum Emission Mask are available for this standard.

Key Type: 1 of N menu
Key Path: **Mode Setup, Radio Std**
History: Modified with PSA firmware revision A.04.00
Added with PSA firmware revision A.02.00
Modified with ESA firmware revision A.08.00
Added with ESA firmware revision A.07.00

Remote Command:

Use [:SENSe]:RADio:STANdard[:SElect] [See “Radio Std” on page 33.](#)

Example: RAD:STAN C2000DS

2.1.1.10 NADC

Sets the specific parameters for the selected measurement (located under the “MEASURE (Spectrum Analysis Mode)” key description) appropriate for industry standard NADC. Channel Power and Intermod TOI measurements are not available when **Device (MS)** is selected. All other measurements are available when this radio standard is selected except: Spectrum Emissions Mask, Harmonic Distortion, Spurious Emissions, and Multi-Carrier Power.

Key Type: 1 of N menu
Key Path: **Mode Setup, Radio Std**
History: Modified with PSA firmware revision A.04.00
Added with PSA firmware revision A.02.00
Modified with ESA firmware revision A.08.00
Added with ESA firmware revision A.07.00

Remote Command:

Use [:SENSe]:RADio:STANdard[:SElect] [See “Radio Std” on page 33.](#)

Example: RAD:STAN NADC

2.1.1.11 PDC

Sets the specific parameters for the selected measurement (located under the “MEASURE (Spectrum Analysis Mode)” key description) appropriate for industry standard PDC. The Burst Power measurement is not available when **Device (BTS)** is selected. The Channel Power and Intermod TOI measurements are not available when **Device (MS)** is selected. All other measurements except Multi-Carrier Power, Harmonic Distortion, Spurious Emissions and Spectrum Emission Mask measurements are available for this standard.

Key Type: 1 of N menu
 Key Path: **Mode Setup, Radio Std**
 History: Modified with PSA firmware revision A.04.00
 Added with PSA firmware revision A.02.00
 Modified with ESA firmware revision A.08.00
 Added with ESA firmware revision A.07.00

Remote Command:

Use [:SENSE]:RADio:STANdard[:SELEct] See “Radio Std” on page 33.

Example: RAD:STAN PDC

2.1.1.12 Bluetooth™

Sets the specific parameters for the selected measurement (located under the “MEASURE (Spectrum Analysis Mode)” key description) appropriate for industry standard Bluetooth™. Power Stat CCDF and Burst Power are the only measurements available for this standard.

Key Type: 1 of N menu
 Key Path: **Mode Setup, Radio Std**
 History: Modified with PSA firmware revision A.04.00
 Added with PSA firmware revision A.02.00
 Modified with ESA firmware revision A.08.00
 Added with ESA firmware revision A.07.00

Remote Command:

Use [:SENSE]:RADio:STANdard[:SELEct] See “Radio Std” on page 33.

Example: RAD:STAN BLUE

2.1.1.13 TETRA

Sets the specific parameters for the selected measurement (located under the “MEASURE (Spectrum Analysis Mode)” key description) appropriate for industry standard TETRA. This standard is only available for the Channel Power and ACP measurements.

Key Type: 1 of N menu
Key Path: **Mode Setup, Radio Std**
History: Added with PSA firmware revision A.03.00
Added with ESA firmware revision A.09.00

Remote Command:

Use [:SENSE]:RADio:STANdard[:SElect] See “Radio Std” on page 33.

Example: RAD:STAN TETR

2.1.1.14 FCC Part 15 Subpart F (PSA Only)

Sets the specific parameters for the selected measurement (located under the “MEASURE (Spectrum Analysis Mode)” key description) appropriate for unlicensed devices. This standard is only available for the Spurious Emissions measurement.

Key Type: 1 of N menu
Key Path: **Mode Setup, Radio Std**
History: Added with PSA firmware revision A.06.00

Remote Command:

Use [:SENSE]:RADio:STANdard[:SElect] See “Radio Std” on page 33.

Example: RAD:STAN FCC15

2.1.1.15 WLAN

Accesses the WLAN radio standards key menu to enable you to select a WLAN standard. Selecting a radio standard modifies spectrum analyzer settings for the SEM measurement activated under the **MEASURE** menu.

2.1.1.15.1 802.11a

Sets the specific parameters for the selected measurement (located under the “MEASURE (Spectrum Analysis Mode)” key description) appropriate for industry standard 802.11a. This standard is only available for the Spectrum Emission Mask (SEM) measurement.

Key Type: 1 of N menu
Key Path: **Mode Setup, Radio Std**

History: Added with PSA firmware revision A.08.00

Remote Command:

Use [:SENSE]:RADio:STANdard[:SElect] See “Radio Std” on page 33.

Example: RAD:STAN WL802DOT11A

2.1.1.15.2 802.11b

Sets the specific parameters for the selected measurement (located under the “MEASURE (Spectrum Analysis Mode)” key description) appropriate for industry standard 802.11b. This standard is only available for the Spectrum Emission Mask (SEM) measurement.

Key Type: 1 of N menu

Key Path: **Mode Setup, Radio Std**

History: Added with PSA firmware revision A.08.00

Remote Command:

Use [:SENSE]:RADio:STANdard[:SElect] See “Radio Std” on page 33.

Example: RAD:STAN WL802DOT11B

2.1.1.15.3 802.11g

Sets the specific parameters for the selected measurement (located under the “MEASURE (Spectrum Analysis Mode)” key description) appropriate for industry standard 802.11g. This standard is only available for the Spectrum Emission Mask (SEM) measurement.

Key Type: 1 of N menu

Key Path: **Mode Setup, Radio Std**

History: Added with PSA firmware revision A.08.00

Remote Command:

Use [:SENSE]:RADio:STANdard[:SElect] See “Radio Std” on page 33.

Example: RAD:STAN WL802DOT11G

2.1.1.15.4 802.11n

Sets the specific parameters for the selected measurement (located under the “MEASURE (Spectrum Analysis Mode)” key description) appropriate for industry standard 802.11n. This standard is only available for the Spectrum Emission Mask (SEM) measurement.

Key Type: 1 of N menu

Key Path: **Mode Setup, Radio Std**

History: Added with PSA firmware revision A.09.18

Remote Command:

Use [:SENSe]:RADio:STANdard[:SElect] See “Radio Std” on page 33.

Example: RAD:STAN WL802DOT11N

2.1.1.15.5 Hiper LAN/2

Sets the specific parameters for the selected measurement (located under the “MEASURE (Spectrum Analysis Mode)” key description) appropriate for industry standard Hiper LAN2. This standard is only available for the Spectrum Emission Mask (SEM) measurement.

Key Type: 1 of N menu

Key Path: **Mode Setup, Radio Std**

History: Added with PSA firmware revision A.08.00

Remote Command:

Use [:SENSe]:RADio:STANdard[:SElect] See “Radio Std” on page 33.

Example: RAD:STAN HIPERLAN2

2.1.1.16 DVB-T

Accesses the DVB-T key menu to enable you to select a DVB-T mask filtering standard. Selecting a DVB-T filtering standard modifies spectrum analyzer settings for the CHP or CCDF measurement activated under the **MEASURE** menu.

2.1.1.16.1 L/SECAM/NICAM

Pressing **L/SECAM/NICAM** selects the filtering masks for the L/SECAM/NICAM analog television system. This standard is only available for the channel power and CCDF measurements

Key Path: **Mode Setup, DVB-T**

History: Added with PSA firmware revision A.04.00

Added with ESA firmware revision A.10.00

Remote Command:

Use [:SENSe]:RADio:STANdard[:SElect] See “Radio Std” on page 33.

Example: RAD:STAN DVBTLSN

2.1.1.16.2 G/PAL/NICAM

Pressing **G/PAL/NICAM** selects the filtering masks for the G/PAL/NICAM analog television system. This standard is only available for the channel power and CCDF measurements.

NOTE The ESA series analyzers require Fast ADC (Option AXX or B7D) to be installed for CCDF operation.

Key Path: **Mode Setup, DVB-T**
 History: Added with PSA firmware revision A.04.00
 Added with ESA firmware revision A.10.00

Remote Command:

Use [:SENSE]:RADio:STANdard[:SElect] See “Radio Std” on page 33.

Example: RAD:STAN DVBTGPN

2.1.1.16.3 I/PAL/NICAM

Pressing **I/PAL/NICAM** selects the filtering masks for the I/PAL/NICAM analog television system. This standard is only available for the channel power and CCDF measurements.

NOTE The ESA series analyzers require Fast ADC (Option AXX or B7D) to be installed for CCDF operation.

Key Path: **Mode Setup, DVB-T**
 History: Added with PSA firmware revision A.04.00
 Added with ESA firmware revision A.10.00

Remote Command:

Use [:SENSE]:RADio:STANdard[:SElect] See “Radio Std” on page 33.

Example: RAD:STAN DVBTIPN

2.1.1.17 S-DMB

Accesses the S-DMB radio standards key menu to enable you to select a S-DMB standard. Selecting a radio standard modifies spectrum analyzer settings for the Spurious Emissions measurement activated under the **MEASURE** menu. This standard is only available for the Channel Power, Occupied BW, and ACP measurements

Key Type: 1 of N menu
 Key Path: **Mode Setup, Radio Std**
 History: Added with PSA firmware revision A.06.00

2.1.1.17.1 System E

(PSA Only): Sets the specific parameters for the selected measurement (located under the “MEASURE (Spectrum Analysis Mode)” key description) appropriate for industry standard System E. This standard is only available for the Channel Power, Occupied BW, or ACP measurements.

Key Type: 1 of N menu
Key Path: **Mode Setup, Radio Std**
History: Added with PSA firmware revision A.06.00

Remote Command:

Use [:SENSE]:RADio:STANdard[:SELEct] See “Radio Std” on page 33.

Example: RAD:STAN DVBTGPN

2.1.1.18 UWB

Accesses the UWB radio standards key menu to enable you to select a UWB standard. Selecting a radio standard modifies spectrum analyzer settings for the Spurious Emissions measurement activated under the **MEASURE** menu.

Key Type: 1 of N menu
Key Path: **Mode Setup, Radio Std**
History: Added with PSA firmware revision A.06.00

2.1.1.18.1 UWB Indoor

Sets the specific parameters for the selected measurement (located under the “MEASURE (Spectrum Analysis Mode)” key description) appropriate for UWB Indoor standard. This standard is only available for the Spurious Emissions measurement.

Key Type: 1 of N menu
Key Path: **Mode Setup, Radio Std**
History: Added with PSA firmware revision A.06.00

Remote Command:

Use [:SENSE]:RADio:STANdard[:SELEct] See “Radio Std” on page 33.

Example: RAD:STAN UWBINDOOR

2.1.2 Radio Std Setup

Accesses the key menu for selecting the device, packet type, or signal bandwidth to be measured.

Key Path: **Mode Setup**

History: Modified with PSA firmware revision A.04.00
Added with PSA firmware revision A.02.00
Modified with ESA firmware revision A.08.00
Added with ESA firmware revision A.07.00

Remote Command:

There is no equivalent remote command.

2.1.2.1 Signal BW

Allows you to set the measurement bandwidth when **Radio Std (None)** is selected. This function is available only when you select None as the standard.

Key Path: **Mode Setup, Radio Std Setup**

Factory Preset: 3.0 MHz

Default Terminator: Hz

Range: The non-zero span range of the analyzer

History: Modified with PSA firmware revision A.04.00
Added with PSA firmware revision A.02.00
Modified with ESA firmware revision A.08.00
Added with ESA firmware revision A.07.00

Remote Command:

```
[ :SENSe ] :RADio:STANdard:SBwidth <freq>
```

```
[ :SENSe ] :RADio:STANdard:SBwidth?
```

Example: RAD:STAN:SBW 2MHZ

2.1.2.2 Device BTS/MS

This function is only available when you have selected the standard: IS-95, J-STD-008, cdma2000, W-CDMA, NADC, PDC, TETRA, or GSM. It enables you to select either the base transmitter station (BTS) setup defaults or the mobile station (MS) defaults for the standard that you have selected. This key is unavailable when you select Bluetooth™ or FCC Part 15.

Key Path: **Mode Setup, Radio Std Setup**

One-Button Measurement Functions Mode Setup (Spectrum Analysis Mode)

Factory Preset: BTS

History: Modified with PSA firmware revision A.04.00
Added with PSA firmware revision A.02.00
Modified with ESA firmware revision A.08.00
Added with ESA firmware revision A.07.00

Remote Command:

```
[ :SENSE ] :RADio:STANdard:DEVIce BTS |MS
```

```
[ :SENSE ] :RADio:STANdard:DEVIce?
```

Example: RAD:STAN:DEV MS

2.1.2.3 Packet Type

This function is only available when the standard you have selected is Bluetooth™. It enables you to set the instrument settings for testing DH1, DH3, or DH5 packet type.

Key Path: **Mode Setup, Radio Std Setup**

Factory Preset: DH1

History: Modified with PSA firmware revision A.04.00
Added with PSA firmware revision A.02.00
Modified with ESA firmware revision A.08.00
Added with ESA firmware revision A.07.00

Remote Command:

```
[ :SENSE ] :RADio:STANdard:PACKet DH1 |DH3 |DH5
```

```
[ :SENSE ] :RADio:STANdard:PACKet?
```

Example: RAD:STAN:PACK DH1

2.1.2.4 Band Class

This function is only available when you have selected the standard: IS-95C. It enables you to select the band class.

Key Path: **Mode Setup, Radio Std Setup**

Factory Preset: US/K or Cell

History: Modified with PSA firmware revision A.04.00
Added with PSA firmware revision A.02.00
Modified with ESA firmware revision A.08.00
Added with ESA firmware revision A.07.00

Remote Command:

```
[ :SENSe] :RADio:STANdard:BAND:CLASs BC0|BC1
```

```
[ :SENSe] :RADio:STANdard:BAND:CLASs?
```

Example: RAD:STAN:BAND:CLAS BC1

2.1.3 Retain Params

Enables you to retain the base-instrument parameter settings used by individual measurements that are typically lost when switching between measurements.

When **Retain Params** is set to **Off**, the values of the fully configurable parameters are not saved and recalled during a measurement change.

When **Retain Params** is set to **On**, the fully configurable parameters will be saved and recalled during a measurement change, along with **Span**, **Ref Level**, **Single/Cont**, **Detector**, **Avg/VBW Type**, **Points**, and if applicable, **Spectrum/Bar/Combined** and **Graticule On/Off**.

NOTE When **Radio Std** or **Radio Std Setup** is changed, **Retain Params** is set to **Off**. Once **Retain Params** has been set to **Off**, parameters will no longer be retained and any settings you may have entered will be lost.

Key Path: **Mode Setup**

Factory Preset: Off

History: Added with PSA firmware revision A.04.00

 Added with ESA firmware revision A.10.00

Remote Command:

```
[ :SENSe] :RADio:STANdard:RPARams [ :STATe] ON|Off|1|0
```

```
[ :SENSe] :RADio:STANdard:RPARams [ :STATe] ?
```

Example: RAD:STAN:RPAR Off

2.1.4 Enable All Measurements

Enable All Measurements allows you to access measurements that are disabled. Not all measurements are available for a particular radio standard. When you select a radio standard, the keys are grayed out for the measurements that are not available. These disabled measurements do not have default settings for the standard that you have selected. So you have to configure the settings yourself when you use them. See also the **Retain Params** key function.

One-Button Measurement Functions Mode Setup (Spectrum Analysis Mode)

If you set **Enable All Measurements** to Yes and you enter one of the measurements that was disabled, then the **Enable All Measurements** function will not be available (grayed out). You cannot turn it off until you enter a measurement that is valid for your selected standard.

Key Path: **Mode Setup**

Factory Preset: No

History: Added with PSA firmware revision A.04.00
Added with ESA firmware revision A.10.00

Remote Command:

```
[ :SENSe ] :RADio:STANdard:EAMeas YES|NO
```

```
[ :SENSe ] :RADio:STANdard:EAMeas?
```

Example: RAD:STAN:EAM YES

2.1.5 Autorange of Power Setting (Remote command only)

This command is the remote version of the **Optimize Ref Level** key. If this function is applicable to the currently selected measurement, this command sets the reference level and attenuator to optimum values based on the signal present at the input. Channel Power, Occupied Bandwidth, ACP, Multi Carrier Power, CCDF, Harmonic Distortion, Burst Power, Intermod (TOI) and SEM measurements are the only supported measurements for the reference level optimization.

NOTE There is always a minimum of 5 dB for ESA or 6 dB for PSA of attenuation set to protect the analyzer input.

History: Modified with PSA firmware revision A.04.00
Added with PSA firmware revision A.02.00
Modified with ESA firmware revision A.08.00
Added with ESA firmware revision A.07.00

Remote Command:

```
[ :SENSe ] :POWer [ :RF ] :RANGe:AUTO ONCE
```

Example: POW:RANG:AUTO ONCE

2.2 MEASURE (Spectrum Analysis Mode)

In the Spectrum Analysis mode (see the **MODE** key), this key displays a menu that lets you make transmitter power measurements such as adjacent channel power, occupied bandwidth, and harmonic distortion measurements. If other modes are available and have been selected, the measurements for that particular mode will be displayed. Some common settings can be made for these measurements using the function under the **Mode Setup** key. For example, you may select one of several radio standards available by pressing **Mode Setup, Radio Std.**

Use **Meas Control** to pause and resume the currently selected measurement and to select between continuous or single measurements. For information about **Meas Control**, see Volume 1, *Core Spectrum Analyzer Functions User's and Programmer's Reference*.

NOTE The measurements described in this book are available in SA mode (see **MODE** key). Other measurements are available in other modes if an optional personality is installed, use the appropriate user's guide for information about those modes.

Command Interactions: MEASURE, CONFIGure, FETCh, INITiate and READ

Figure 1 Measurement Group of Commands

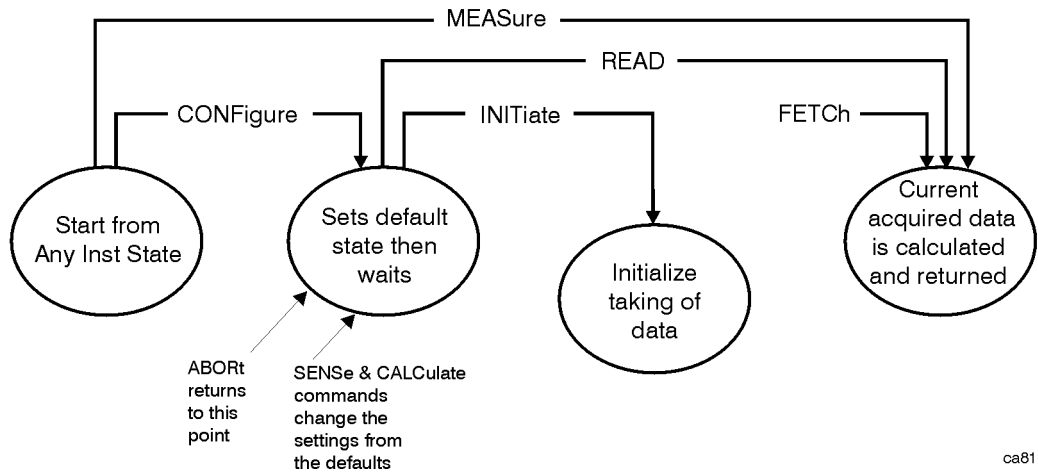

Measure Commands:

`:MEASure:<measurement> [n] ?`

This is a fast single-command way to make a measurement using the factory default instrument settings. These are the settings and units that conform to the Mode Setup settings (for example, radio standard) that you have currently selected.

- Stops the current measurement (if any) and sets up the instrument for the specified measurement using the factory defaults
- Initiates the data acquisition for the measurement
- Blocks other SCPI communication, waiting until the measurement is complete before returning results.
- If the function does averaging, it is turned on and the number of averages is set to 10.
- After the data is valid it returns the scalar results, or the trace data, for the specified measurement. The type of data returned may be defined by an [n] value that is sent with the command.

The scalar measurement results will be returned if the optional [n] value is not included, or is set to 1. If the [n] value is set to a value other than 1, the selected trace data results will be returned. See each command for details of what types of scalar results or trace data results are available.

ASCII is the default format for the data output. (Older versions of Spectrum Analysis and Phase Noise mode measurements only use ASCII.) The binary data formats should be used for handling large blocks of data since they are smaller and faster than the ASCII format. Refer to the `FORMat:DATA` command for more information.

If you need to change some of the measurement parameters from the factory default settings you can set up the measurement with the `CONFigure` command. Use the commands in the `SENSe:<measurement>` and `CALCulate:<measurement>` subsystems to change the settings. Then you can use the `READ?` command to initiate the measurement and query the results. See [Figure 1](#).

If you need to repeatedly make a given measurement with settings other than the factory defaults, you can use the commands in the `SENSe:<measurement>` and `CALCulate:<measurement>` subsystems to set up the measurement. Then use the `READ?` command to initiate the measurement and query results.

Measurement settings persist if you initiate a different measurement and then return to a previous one. Use `READ:<measurement>?` if you want to use those persistent settings. If you want to go back to the default settings, use `MEASure:<measurement>?`.

Configure Commands:

`:CONFigure:<measurement>`

This command stops the current measurement (if any) and sets up the instrument for the specified measurement using the factory default instrument settings. It sets the instrument to single measurement mode but should not initiate the taking of measurement data unless `INIT:CONTinuous` is ON. After you change any measurement settings, the `READ` command can be used to initiate a measurement without changing the settings back to their defaults. In Spectrum Analysis mode the `CONFigure` command also turns the averaging function on and sets the number of averages to 10 for all measurements.

The `CONFigure?` query returns the current measurement name.

Fetch Commands:

:FETCh:<measurement>[n]?

This command puts selected data from the most recent measurement into the output buffer. Use FETCh if you have already made a good measurement and you want to return several types of data (different [n] values, for example both scalars and trace data) from a single measurement. FETCh saves you the time of re-making the measurement. You can only FETCh results from the measurement that is currently active, it will not change to a different measurement.

If you need to get new measurement data, use the READ command, which is equivalent to an INITiate followed by a FETCh.

The scalar measurement results will be returned if the optional [n] value is not included, or is set to 1. If the [n] value is set to a value other than 1, the selected trace data results will be returned. See each command for details of what types of scalar results or trace data results are available. The binary data formats should be used for handling large blocks of data since they are smaller and transfer faster than the ASCII format. (FORMat:DATA)

FETCh may be used to return results other than those specified with the original READ or MEASure command that you sent.

INITiate Commands:

:INITiate:<measurement>

This command is not available for measurements in all the instrument modes:

- Initiates a trigger cycle for the specified measurement, but does not output any data. You must then use the FETCh<meas> command to return data. If a measurement other than the current one is specified, the instrument will switch to that measurement and then initiate it.

For example, suppose you have previously initiated the ACP measurement, but now you are running the channel power measurement. If you send INIT:ACP? it will change from channel power to ACP and will initiate an ACP measurement.

- Does not change any of the measurement settings. For example, if you have previously started the ACP measurement and you send INIT:ACP? it will initiate a new ACP measurement using the same instrument settings as the last time ACP was run.
- If your selected measurement is currently active (in the idle state) it triggers the measurement, assuming the trigger conditions are met. Then it completes one trigger cycle. Depending upon the measurement and the number of averages, there may be multiple data acquisitions, with multiple trigger events, for one full trigger cycle. It also holds off additional commands on GPIB until the acquisition is complete.

READ Commands:

:READ:<measurement>[n]?

- Does not preset the measurement to the factory default settings. For example, if you have previously initiated the ACP measurement and you send READ:ACP? it will initiate a new measurement using the same instrument settings.
- Initiates the measurement and puts valid data into the output buffer. If a measurement other than the current one is specified, the instrument will switch to that measurement before it initiates the measurement and returns results.

For example, suppose you have previously initiated the ACP measurement, but now you are running the channel power measurement. Then you send READ:ACP? It will change from channel power back to ACP and, using the previous ACP settings, will initiate the measurement and return results.

- Blocks other SCPI communication, waiting until the measurement is complete before returning the results

If the optional [n] value is not included, or is set to 1, the scalar measurement results will be returned. If the [n] value is set to a value other than 1, the selected trace data results will be returned. See each command for details of what types of scalar results or trace data results are available. The binary data formats should be used when handling large blocks of data since they are smaller and faster than the ASCII format. (FORMat:DATA)

2.2.1 Current Measurement Query (Remote Command Only)

This command returns the name of the measurement that is currently running.

Remote Command:

:CONFigure?

Example: CONF?

2.2.2 Test Current Results Against all Limits (Remote Command Only)

Allows you to check the status of the fail flag. This will return true (non-zero) if the flag is set to FAIL. A false (zero) is returned if the flag is set to TRUE. The fail flag is updated after every sweep.

This flag is only used by Channel Power (DVD-T radio standards only), Adjacent Channel Power, Multi-Carrier Power, Spurious Emissions, and SEM. For all other measurements, the fail flag will not be displayed and the SCPI command will return 0.

Remote Command:

:CALCulate:CLIMits:FAIL?

Example: CALC:CLIM:FAIL?

2.2.3 Meas Off

This key accesses the core spectrum analysis measurement functionality. It turns off the current one-button measurement so there are no keys available in the **Meas Setup** menu. See the spectrum analysis measurement features described in Volume 1 “*Core Spectrum Analyzer Functions*”.

Key Path: **MEASURE**
Saved State: Saved in state
Factory Preset: Meas Off is selected.

Remote Command:

:CONFigure:SANalyzer

Example: CONF:SAN

2.2.4 Channel Power

Channel Power measures the power and power spectral density in the channel bandwidth that you specify. One marker pair on the display indicates the edges of the channel bandwidth. The center frequency, reference level, and channel bandwidth must be set by the user. For more information see “[Meas Setup \(Channel Power—CHP\)](#)” on page 123.

You can configure measurement settings by pressing **Meas Setup** after selecting **Channel Power**. You can make a measurement in single or continuous sweep mode. Pressing **Meas Control** enables you to pause or restart a measurement, or toggle between continuous and single measurement. To set **Ref Level** automatically, use **Optimize Ref Level**.

The power calculation method used to determine the channel power is a traditional method known as the integration bandwidth (IBW) method. A swept spectrum is used as the basis for this calculation. Therefore, it is important to set the resolution bandwidth correctly before making this measurement using the following formula:

$$RBW = k(span)/n$$

Where k is a value between 1.2 and 4.0 and n is the number of trace points.

NOTE Because of the noise-like nature of the signals being measured, the video bandwidth should be ≥ 10 times the resolution bandwidth.

Figure 2-1 ESA Channel Power Measurement Results

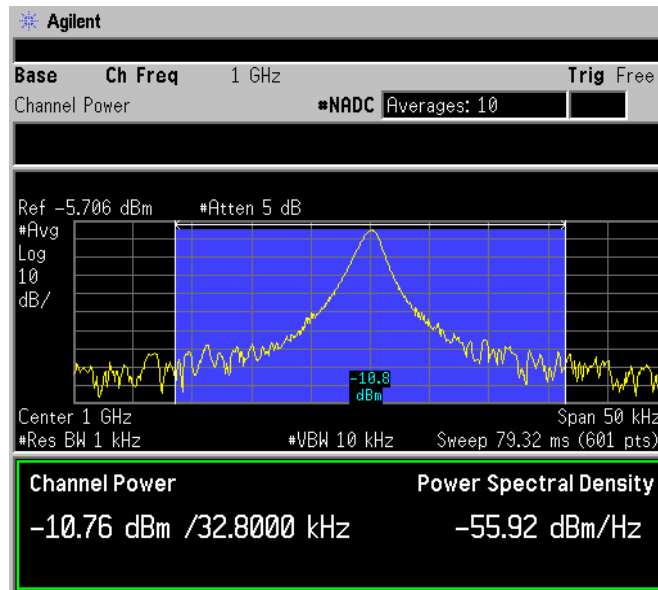
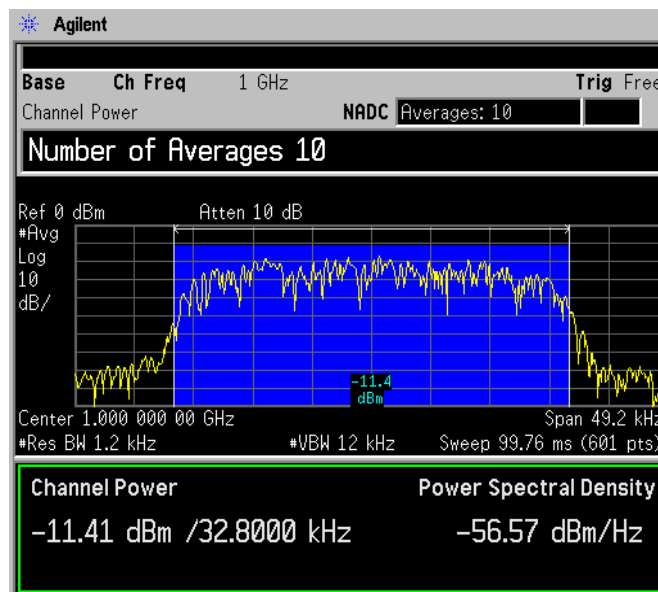

Figure 2-2 PSA Channel Power Measurement Results



NOTE The displayed trace is the current trace, not the averaged trace.

Pressing **Meas Setup** after **Channel Power** has been selected will access the channel power measurement setup menu. Pressing **Radio Standard** after **Mode Setup** has been selected will access all the Radio Standards available for which this measurement can be applied. Pressing **Meas Control** after **Channel Power** has been selected will access the channel power measurement control menu which allows you to pause or restart your measurement, or toggle between continuous and single measurement.

One-Button Measurement Functions
MEASURE (Spectrum Analysis Mode)

When a DVB-T radio standard is selected, this measurement will also compare the input signal against a pre-defined spectrum mask. The mask amplitudes defined in the DVB-T specification (ETSI EN 300 744 V1.4.1) range from 0 dB to 100 dB. This is for power measured in a 4 kHz bandwidth therefore an adjustment to these values will need to be made as the measurement is made in a 7.61 MHz bandwidth.

The measurement makes two sweeps, one in a 4 kHz bandwidth and one in a 7.61 MHz bandwidth, then computes the difference between the two. This value will be used to adjust the mask settings. As this value is calculated as part of the measurement setup, it is expected that the DVB-T signal to be measured will be present prior to the standard being selected. The mask will be positioned relative to the power measured in the 7.61 MHz bandwidth. The pass/fail indicator will be used to determine if the input signal exceeds the mask or not.

If the current span setting is narrower than the mask width, the mask will not be displayed and the message 10191 is displayed in the error queue. Increase the span to at least the mask width to display the mask. When the mask is not displayed, the pass/fail functionality will not be executed, therefore no pass/fail flag will be displayed.

To ensure accuracy this measurement requires a specific minimum Sweep Point to Span ratio. This is calculated using; $\text{Sweep Points} = \text{Span} / (\text{Closest Mask Breakpoint} / 2)$, then rounded off.

For DVB-T measurements using a 24 MHz Span, the number of Sweep Points is 2001. If the Sweep Point to Span ratio is changed to a value less than the value obtained using the above algorithm, the message 10192 is then displayed, although the measurement is still made using the new sweep point to span ratio.

Key Path: **MEASURE**

Remote Command:

Measurement Results Available	
Command	Results Returned
:CONFigure:CHPower :INITiate:CHPower	Not Applicable
:FETCh:CHPower? :MEASure:CHPower? :READ:CHPower?	Returns two values that correspond to the Channel Power and Power Spectral Density.
:FETCh:CHPower:CHPower? :MEASure:CHPower:CHPower? :READ:CHPower:CHPower?	Returns a single value that corresponds to the Channel Power.
:FETCh:CHPower:DENSity? :MEASure:CHPower:DENSity? :READ:CHPower:DENSity?	Returns a single value that corresponds to the Power Spectral Density.

Remote Command

Notes: The main channel power is returned in the current amplitude units, and the density value is returned in current amplitude units/Hz

Example: FETC:CHP? or MEAS:CHP? or READ:CHP? command returns scalar results of main channel power and power density.

FETC:CHP:CHP? or MEAS:CHP:DENS? or READ:CHP:DENS? commands will return the single scalar result specified.

2.2.5 Occupied BW

Occupied Bandwidth integrates the power of the displayed spectrum and puts markers at the frequencies between which a selected percentage of the power is contained. The measurement defaults to 99% of the occupied bandwidth power. The power-bandwidth routine first computes the combined power of all signal responses contained in the trace. For 99% occupied power bandwidth, markers are placed at the frequencies on either side of 99% of the power and 1% of the power is evenly distributed outside the markers. The difference between the marker frequencies is the 99% power bandwidth and is the value displayed. For more information see “[Meas Setup \(Occupied Bandwidth—OBW\)](#)” on page 165.

The occupied bandwidth function also indicates the difference between the analyzer center frequency and the center frequency of the channel. This “Transmit Freq Error” is defined as the difference between the $(f_1 + f_2)/2$ and the tuned center frequency of the signal. See [Figure 2-3 on page 58](#).

The occupied bandwidth measurement can be made in single or continuous sweep mode. The center frequency, reference level, and channel spacing must be set by the user.

To configure measurement settings, press **Meas Setup** after selecting **Occupied BW**. Pressing **Radio Standard** after **Mode Setup** has been selected will access all the Radio Standards available for which this measurement can be applied. Pressing **Meas Control** enables you to pause or restart a measurement, or toggle between continuous and single measurement.

Key Path: **MEASURE**

Remote Command:

Measurement Results Available	
Command	Results Returned
:CONFigure:OBW :INITiate:OBW	Not Applicable
:FETCh:OBW? :MEASure:OBW? :READ:OBW?	Returns two values that correspond to the Occupied BW and Transmit Frequency Error in Hertz.
:FETCh:OBW:OBWidth? :MEASure:OBW:OBWidth? :READ:OBW:OBWidth?	Returns a single value that corresponds to the Occupied BW in Hertz.

One-Button Measurement Functions
MEASURE (Spectrum Analysis Mode)

Measurement Results Available	
Command	Results Returned
:FETCh:OBW:FERRor?:MEASure: OBW:FERRor? :READ:OBW:FERRor?	Returns a single value that corresponds to the Transmit Frequency Error in Hertz.
:FETCh:OBW:XDB? :MEASure:OBW:XDB? :READ:OBW:XDB?	Returns a single value that corresponds to the x dB BW in Hertz.

Remote Command Notes: The results for both values are returned in Hz.

Example: FETC:OBW? or MEAS:OBW? or READ:OBW? command returns scalar results of occupied bandwidth and transmit frequency error.

FETC:OBW:FERR? or MEAS:OBW:FERR? or READ:OBW:FERR? commands will return the single scalar result specified.

Figure 2-3 Occupied Bandwidth Measurement Results

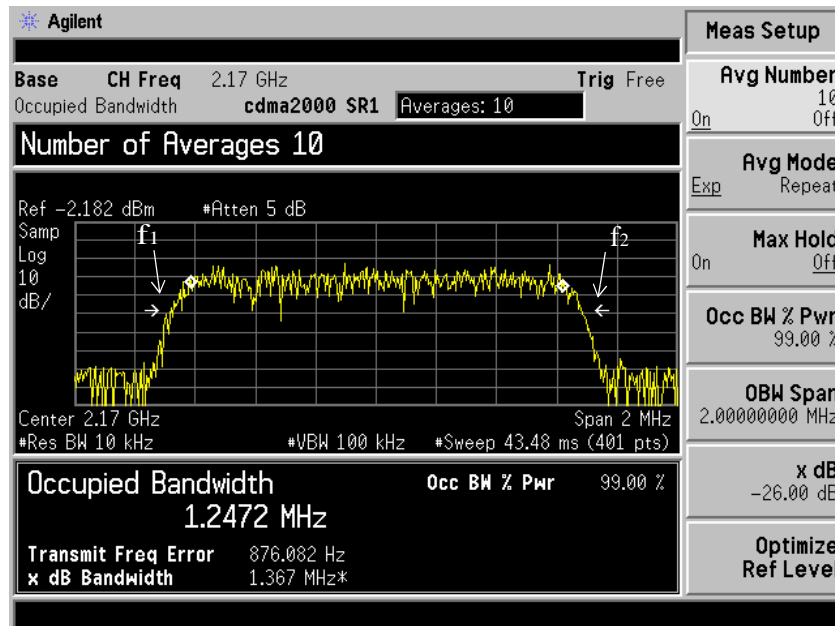

2.2.6 Adjacent Channel Power—ACP

Adjacent Channel Power (ACP) is a measure of the power that leaks into adjacent transmit channels. Depending on the radio standard selected from the Mode Setup menu, this measurement can run in several different modes in order to measure different types of signals. For more information see “[Meas Setup \(Adjacent Channel Power—ACP\)](#)” on page 83.

ACP measures the power present in adjacent transmit channels. The span is set according to the six available offsets and their associated integration bandwidths defined by you or the selected radio standard (**Mode Setup, Radio Std**). The root-raised cosine filter also affects the span and is only available for NADC, 3GPP W-CDMA, and TETRA radio standards.

- When **Method** is set to **IBW**, one sweep of the trace will be taken, and the band power for each offset will be computed. Results will be displayed relative to the total power or the power spectral density, depending on your selection after pressing **Meas Setup**, **Meas Type**. You may view the results as the current trace, bar graph, or a combination.
- When **Method** is set to **RBW**, the main channel and offsets will be measured in zero span and the combined results reported according to the **Meas Type** selection.
- When **Method** is set to **Fast**, the five point ACLR measurement method is used for improved speed of making ACP measurements. **Fast** is only enabled for the 3GPP W-CDMA radio standard.

The measurement settings may be configured by pressing **Meas Setup** after **ACP** has been selected. Pressing **Radio Standard** after **Mode Setup** has been selected will access all the Radio Standards available for which this measurement can be applied. Pressing **Meas Control** allows you to pause or restart your measurement, or toggle between continuous and single measurement mode.

Key Path: **MEASURE**

Remote Command:

Measurement Results Available			
Command	n	Condition	Results Returned
:CONFigure:ACP :INITiate:ACP			Not Applicable
:FETCh:ACP[n]? :MEASure:ACP[n]? :READ:ACP[n]?	not specified, or n=1	Any Meas Type Radio Std = None Only one offset A is on	Returns 3 comma-separated values that correspond to: main channel power, lower-adjacent channel power (dBc), and upper-adjacent channel power (dBc).

One-Button Measurement Functions
MEASURE (Spectrum Analysis Mode)

Measurement Results Available (Continued)			
Command	n	Condition	Results Returned
	not specified, or n=1	Meas Type = Total Power Reference Method = IBW or RBW	Returns 28 comma-separated values, in the following order: <ol style="list-style-type: none"> 1. Center Frequency - relative power (dB) 2. Center Frequency - absolute power (dBm) 3. Center Frequency - relative power (dB) 4. Center Frequency - absolute power (dBm) 5. Negative Offset Frequency (1) - relative power (dB) 6. Negative Offset Frequency (1) - absolute power (dBm) 7. Positive Offset Frequency (1) - relative power (dB) 8. Positive Offset Frequency (1) - absolute power (dBm) ... 25. Negative Offset Frequency (6) - relative power (dB) 26. Negative Offset Frequency (6) - absolute power (dBm) 27. Positive Offset Frequency (6) - relative power (dB) 28. Positive Offset Frequency (6) - absolute power (dBm) <p>The center frequency relative power is relative to the center frequency absolute power, and therefore is always equal to 0.00 dB.</p>
	not specified, or n=1	Meas Type = Total Power Reference Method = Fast	Returns 5 comma-separated values, in the following order: <ol style="list-style-type: none"> 1. Main Carrier- absolute power (dBm) 2. Negative Offset Frequency (1) - absolute power (dBm) 3. Positive Offset Frequency (1) - absolute power (dBm) 4. Negative Offset Frequency (2) - absolute power (dBm) 5. Positive Offset Frequency (2) - absolute power (dBm)

Measurement Results Available (Continued)			
Command	n	Condition	Results Returned
	not specified, or n=1	Meas Type = Power Spectral Density Reference	<p>Returns 28 comma-separated values, in the following order:</p> <ol style="list-style-type: none"> 1. Center Frequency - relative power (dB) 2. Center Frequency - absolute power (dBm/Hz) 3. Center Frequency - relative power (dB) 4. Center Frequency - absolute power (dBm/Hz) 5. Negative Offset Frequency (1) - relative power (dB) 6. Negative Offset Frequency (1) - absolute power (dBm/Hz) 7. Positive Offset Frequency (1) - relative power (dB) 8. Positive Offset Frequency (1) - absolute power (dBm/Hz) ... 25. Negative Offset Frequency (6) - relative power (dB) 26. Negative Offset Frequency (6) - absolute power (dBm/Hz) 27. Positive Offset Frequency (6) - relative power (dB) 28. Positive Offset Frequency (6) - absolute power (dBm/Hz) <p>The center frequency relative power is relative to the center frequency absolute power, and therefore is always equal to 0.00 dB.</p>

Remote Command Notes: The main channel power is returned in the current amplitude units, and the lower and upper channel results are always returned in dB.

Example: FETC:ACP? or MEAS:ACP? or READ:ACP? commands return the scalar results of main channel power, lower channel power (relative), and upper channel power (relative) if only one offset is set to on and the Radio Standard is set to None. Otherwise, 28 values are returned. If **Meas Type** is **Total Power Ref**, these are the main channel power in dBm and in dBc from the carrier (0 dBc) each repeated, followed by the absolute and relative power levels for each lower and upper offset if Meas Type is Total Power Ref. Otherwise they are the main channel power spectral density and relative power spectral density (0 dB) each repeated. Then followed by the absolute and relative spectral density values for each lower and upper offset.

2.2.7 Multi-Carrier Power

Multi-Carrier Power is the measure of the power that leaks into adjacent transmit channels when two or more carriers are present. The results reported are identical to the adjacent power measurement, but the setup is different to allow for two or more carriers. For more information see “[Meas Setup \(Multi-Carrier Power—MCP\)](#)” on page 147.

The measurement settings may be configured by pressing **Meas Setup** after **Multi-Carrier Power** has been selected. Pressing **Meas Control** allows you to pause or restart your measurement, or toggle between continuous and single measurement mode.

Key Path: **MEASURE**

Remote Command:

Measurement Results Available		
Command	n	Results Returned
:CONFigure:MCPower	N/A	Not Applicable

Measurement Results Available (Continued)		
Command	n	Results Returned
:FETCh:MCPower[n]? :MEASure:MCPower[n]? :READ:MCPower[n]?	n=1 (or not specified)	Returns 20 comma-separated scalar results, in the following order. <ol style="list-style-type: none"> 1. 0.0 2. Total carrier power (dBm) 3. 0.0 4. Reference carrier power (dBm) 5. lower 5 MHz offset - relative power (dBc) 6. lower 5 MHz offset - absolute power (dBm) 7. upper 5 MHz offset - relative power (dBc) 8. upper 5 MHz offset - absolute power (dBm) 9. lower 10 MHz offset - relative power (dBc) 10. lower 10 MHz offset - absolute power (dBm) 11. upper 10 MHz offset - relative power (dBc) 12. upper 10 MHz offset - absolute power (dBm) 13. lower 15 MHz offset - relative power (dBc) 14. lower 15 MHz offset - absolute power (dBm) 15. upper 15 MHz offset - relative power (dBc) 16. upper 15 MHz offset - absolute power (dBm) 17. NaN returned 18. NaN returned 19. NaN returned 20. NaN returned <p>If the results are not available, -999.0 is returned.</p>
	n=2...13	Returns absolute and relative values for carrier n-1. If results are not available -999.0 is returned

One-Button Measurement Functions
MEASURE (Spectrum Analysis Mode)

Measurement Results Available (Continued)		
Command	n	Results Returned
	n=14	Returns 36 comma-separated scalar results, in the following order. 1 to 24. All carriers absolute and relative values 25. lower offset A - relative power (dBc) 26. lower offset A - absolute power (dBm) 27. upper offset A - relative power (dBc) 28. upper offset A - absolute power (dBm) 29. lower offset B - relative power (dBc) 30. lower offset B - absolute power (dBm) 31. upper offset B - relative power (dBc) 32. upper offset B - absolute power (dBm) 33. lower offset C - relative power (dBc) 34. lower offset C - absolute power (dBm) 35. upper offset C - relative power (dBc) 36. upper offset C - absolute power (dBm) If the results are not available, -999.0 is returned.

Example: FETC:MCP? or MEA:MCP? or READ:MCP?

2.2.8 Power Stat CCDF

The CCDF measurement is a statistical measurement of a high-level signal or peak power. It shows in both graphical and tabular form for what percentage of the time a signal exceeds its average power, and by how much this average is exceeded. For more information see [“Meas Setup \(Complementary Cumulative Distribution Function—CCDF\)”](#) on page 109.

NOTE ESA Only: CCDF measurement requires the installation of Option AYX (fast time domain sweeps) or Option B7D (Digital Signal Processing with Fast ADC).

For each single sweep of this measurement, the average power is defined by:

$$P_{avg} = \left(\sum_1^n (V^2/Z_0) \right) / n$$

where V is the envelope voltage, Z₀ is the characteristic impedance, and n is the number of samples (32k maximum).

P_{avg} is used as a guideline to define the probability of the samples, which is x dB above the average power. The number of samples collected per sweep depends upon the sampling rate and the setting of the measurement interval. Multiple sweeps may be required if the sample number exceeds the number of samples collected per sweep. The results and the CCDF curve are updated after each sweep.

Results from a 2.17 GHz 3GPP W-CDMA input signal are shown in [Figure 2-4](#).

NOTE It is important to set the correct center frequency before initiating this measurement.

Figure 2-4 Power Stat CCDF Measurement Results

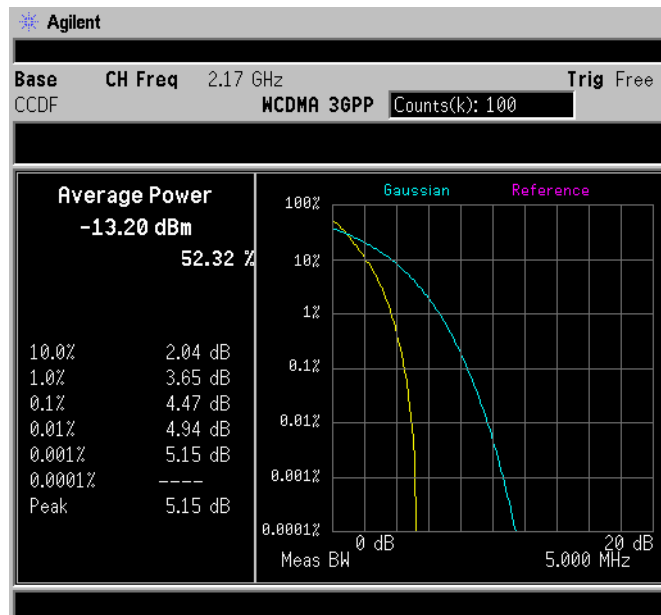

One-Button Measurement Functions
MEASURE (Spectrum Analysis Mode)

Pressing **Meas Setup** after **Power Stat CCDF** has been selected will access the Power Stat CCDF measurement setup menu. The factory defaults provide a good starting point for this measurement. The settings are adjustable, however, to meet specific requirements. Pressing **Radio Standard** after **Mode Setup** has been selected will access all the Radio Standards available for which this measurement can be applied. Pressing **Meas Control** after **Power Stat CCDF** has been selected will access the Power Stat CCDF measurement control menu which allows you to pause or restart your measurement, or toggle between continuous and single measurement.

Key Path: **MEASURE**

Remote Command:

Measurement Results Available		
Command	n	Results Returned
:CONFigure:PSTatistic :INITiate:PSTatistic	N/A	Not Applicable
:FETCh:PSTatistic[n]? :MEASure:PSTatistic[n]? :READ:PSTatistic[n]?	n=1 (or not specified)	Returns 10 scalar results, in the following order. <ol style="list-style-type: none"> 1. Average input power (in dBm) 2. Probability at the average input power (in%) 3. Power level that has 10% of the power 4. Power level that has 1% of the power 5. Power level that has 0.1% of the power 6. Power level that has 0.01% of the power 7. Power level that has 0.001% of the power 8. Power level that has 0.0001% of the power 9. Peak power (in dB) 10. Count
	n=2	Returns a series of 501 floating point numbers (in percent) that represent the current measured power statistics trace. This is the probability at specific power levels (average power), in the following order: <ol style="list-style-type: none"> 1. Probability at 0 dB power 2. Probability at 0.1 dB power 3. Probability at 0.2 dB power ... 501. Probability at 50.0 dB power

Measurement Results Available (Continued)		
Command	n	Results Returned
	n=3	Returns a series of 501 floating point numbers (in percent) that represent the Gaussian trace. This is the probability at specific power levels (average power), in the following order: 1. Probability at 0 dB power 2. Probability at 0.1 dB power 3. Probability at 0.2 dB power ... 501. Probability at 50.0 dB power
	n=4	Returns a series of 501 floating point numbers (in percent) that represent the user-definable reference trace. This is the probability that at specific power levels (average power) will occur, as follows: 1. Probability at 0 dB power 2. Probability at 0.1 dB power 3. Probability at 0.2 dB power ... 501. Probability at 50.0 dB power

Remote Command Notes: To save trace data use the fetch methods shown above.

Example: FETC:PST? or MEAS:PST? or READ:PST?
 FETC:PST2? or MEAS:PST2? or READ:PST2?
 FETC:PST3? or MEAS:PST3? or READ:PST3?

2.2.9 Harmonic Distortion

The range table state determines which harmonics are to be measured. If **Range Table** is set to **Off**, for each harmonic to be measured, the center frequency will be set to the appropriate integer multiple of the fundamental frequency and a sweep taken. The amplitude is calculated by averaging the power in the trace and is displayed in the results table in the results window. The desired Res BW value for each harmonic is calculated by multiplying the harmonic number with the Res BW of the fundamental. This results in the smallest Res BW available being used that is greater than or equal to the computed value. If a Res BW greater than the instrument maximum is calculated then the maximum Res BW of the instrument is used and an asterisk (*) is displayed after the amplitude result of the harmonic to indicate that the desired Res BW was not used. The span for each harmonic is set to zero.

If Range Table is set to On, for each range enabled after the fundamental, the center frequency will be set to the frequency of each range. If the current span is set to zero, the amplitude is calculated by averaging the power in the trace and is displayed in the results table in the results window. If the range has a non-zero span, the amplitude is calculated by making a band-power measurement over the span and is displayed in the results table in the results window.

After the specified number of harmonics have been measured and their amplitudes displayed, the total harmonic distortion is computed and displayed in the left-hand portion of the window (view is set to

One-Button Measurement Functions
MEASURE (Spectrum Analysis Mode)

Harmonics & THD). If the measurement is in single mode, the display will remain at the last harmonic setting and the analyzer sweep will be stopped. If the measurement is in continuous mode, the measurement will continually measure the amplitude of the fundamental and harmonics.

For averaged measurements, you may specify the number of sweeps over which the amplitude of each harmonic is measured. This means that if the **Avg Number** is set to **10**, ten sweeps will be taken and averaged for each harmonic to be measured. The total harmonic distortion would then be calculated from these averaged amplitude readings. Averaging applies only to the amplitude of the harmonic, and does not affect the frequency at which the amplitude is measured.

Refer to your measurement guide for examples of this measurement and the calculation of Total Harmonic Distortion.

Key Path: **MEASURE**

Dependencies/

Couplings: This measurement is not available when using external mixing.

Remote Command:

Measurement Results Available		
Command	n	Results Returned
:CONFigure:HARMonics :INTiate:HARMonics	N/A	Not Applicable
:FETCh:HARMonics:AMPLitude:ALL? :MEASure:HARMonics:AMPLitude:ALL? :READ:HARMonics:AMPLitude:ALL?	N/A	Returns the amplitude values of the first ten harmonics. The first value (for the fundamental) is measured in dBm. The remaining harmonics are measured in dBm from the fundamental. If fewer than ten harmonics are measured, zero is returned for any harmonic not measured.
:FETCh:HARMonics:AMPLitude[n]? :MEASure:HARMonics:AMPLitude[n]? :READ:HARMonics:AMPLitude[n]?	n=1 to 10 (n=1 for n not specified)	Returns the amplitude of the specified harmonic number n, where n=1 returns the amplitude of the fundamental in units of dBm. For example, n = 9 returns the amplitude of the ninth harmonic measured in dBm from the fundamental.
:FETCh:HARMonics[:DISTortion]? :MEASure:HARMonics[:DISTortion]? :READ:HARMonics[:DISTortion]?	N/A	Returns the computed total harmonic distortion as a percentage.
:FETCh:HARMonics:FREQuency:ALL? :MEASure:HARMonics:FREQuency:ALL? :READ:HARMonics:FREQuency:ALL?	N/A	Returns the frequency values of the first ten harmonics, in Hz. The first harmonic is the fundamental. If fewer than ten harmonics are measured, zero is returned for any harmonic not measured.

Measurement Results Available		
Command	n	Results Returned
:FETCh:HARMonics:FREQuency[n]? :MEASure:HARMonics:FREQuency[n]? :READ:HARMonics:FREQuency[n]?	n=2 to 10 (n=1 for n not specified)	Returns the frequency of the specified harmonic number N (in Hz).
:FETCh:HARMonics:FUNDamental? :MEASure:HARMonics:FUNDamental? :READ:HARMonics:FUNDamental?	N/A	Returns the frequency of the fundamental, measured in Hz.
:FETCh:HARMonics[n]? :MEASure:HARMonics[n]? :READ:HARMonics[n]?	n=1 to 2 (n=1 for n not specified)	<p>These commands return the power of the spurious emissions at the selected harmonic frequencies of the current channel frequency using the selected resolution bandwidth filter. You can set the number of harmonics to be measured. For each harmonic, the reference level is set 40 dB above the largest amplitude limit with input attenuation held constant. The attenuation is set to limit the carrier (fundamental) power at the spectrum analyzer input mixer to the value determined by Max Mixer Lvl.</p> <p>not specified or n=1 Returns one value that corresponds to the total harmonic distortion (RMS voltage %).</p> <p>n=2 Returns one value that corresponds to the total harmonic distortion (dB).</p>

Example: FETC:HARM:AMPL:ALL?

MEAS:HARM:AMPL2? returns the amplitude of the second harmonic measured in dBc from the fundamental.

READ:HARM:FREQ10 returns the frequency of the tenth harmonic in Hz.

2.2.10 Burst Power

The burst power measurement is an accurate method of determining the average power for the specified burst. Burst power measures the average power in zero-span mode for the captured burst. This measurement is primarily for use with time domain modulated signals (Bluetooth™, GSM /Edge, and NADC). The burst width, if not user defined, is determined by finding the peak in the captured data, then searching for the first place that the trace is higher than the threshold level. This is considered to be the start of the burst. The stop of the burst is the first position in the trace that falls below the threshold level. The mean carrier power is calculated based on the burst width and the threshold level. Refer to the following figure for clarification of these parameters.

The burst power measurement acquires data from the “Measured Area” above when a radio standard is chosen and when **Meas Setup, Meas Method, Measured Burst Width** is selected. When **Meas Setup, Meas Method, Above Threshold Lvl** is selected, the “Measured Area” extends the burst width delimiter lines to the start and stop points.

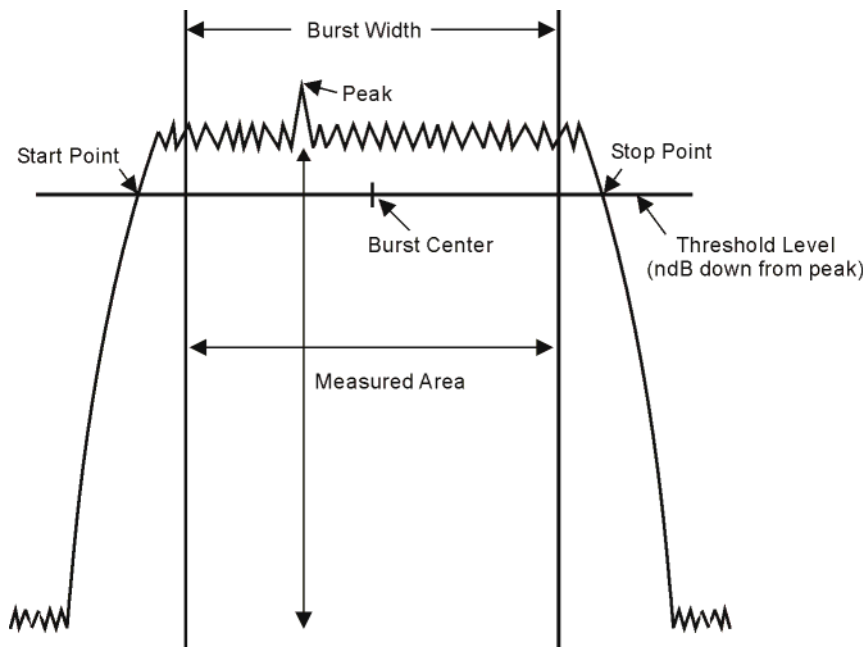

pl746b

The mean carrier power is calculated by:

1. Converting each trace point amplitude from dBm into linear power.
2. Adding the above amplitudes together and dividing by the number of points included in the average.
3. This value is then displayed in logarithmic form (dBm).

$$(P_{avg}) = 10 \log 10 \left\{ \frac{\sum_n^m \left(10^{\frac{p}{10}} \right)}{m - n} \right\}$$

where P_{avg} = average power, n is the start trace point, m = the stop trace point, and p = the trace point amplitude power in dBm.

Figure 2-5 shows an example of the results obtained when measuring a Bluetooth™ signal and with a user-defined burst width.

Figure 2-5 Burst Power Measurement Results

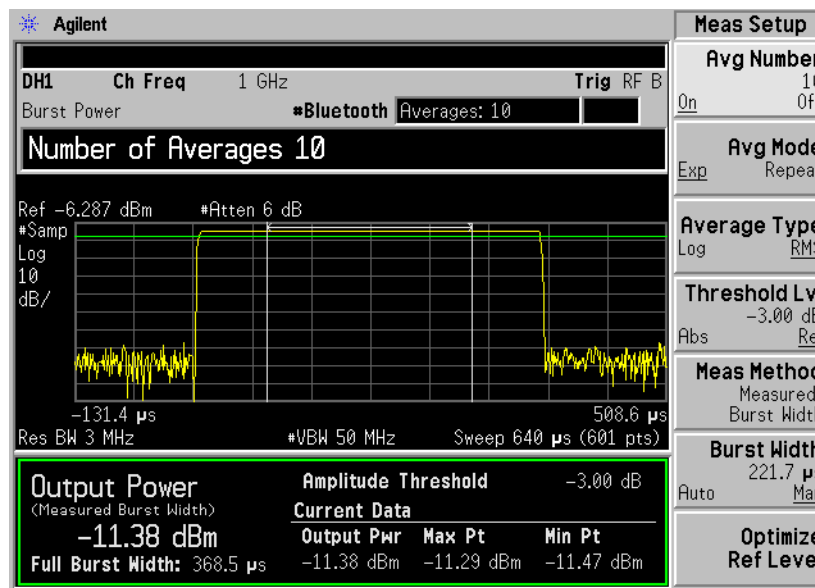

NOTE The analyzer defaults to zero-span mode and the sweep time is set to capture at least one burst. The sweep time can be changed by pressing **Sweep, Sweep Time**.

Pressing **Meas Setup** after **Burst Power** has been selected displays the burst power measurement setup menu. Pressing **Meas Control** after **Burst Power** has been selected displays the burst power control menu, where you can pause or restart a measurement, or toggle between continuous and single measurement.

NOTE The measurements described above are those available in SA mode (see the **MODE** key). Other measurements are available in other modes if an optional personality is installed.

Key Path: **MEASURE**

One-Button Measurement Functions
MEASURE (Spectrum Analysis Mode)

Remote Command:

Measurement Results Available		
Command	n	Results Returned
:CONFigure:BPOWer :INITiate:BPOWer	N/A	Not Applicable
:FETCh:BPOWer[n]? :MEASure:BPOWer[n]? :READ:BPOWer[n]?	n=1 (or not specified)	Returns 10 scalar results, in the following order. <ol style="list-style-type: none"> 1. Sample time 2. Power (RMS of carrier power) 3. Power averaged 4. Number of samples, 5. Amplitude threshold (relative) 6. Maximum trace point on the measured part of the burst. 7. Minimum trace point on the measured part of the burst. 8. Burst width (actual measured width, using the threshold level) 9. Measured time 10. Measured points
	n=2	Returns the displayed RF envelope trace data separated by commas. The number of data values is determined by the setting of the trace points parameter.

Example: FETC:BPOW? or MEAS:BPOW? or READ:BPOW?

2.2.11 Intermod (TOI)

The third order intermodulation (TOI) measurement computes and displays the output intercept point (IP3), and places markers upon the trace to indicate the measured signals and third-order products. For more information see “[Meas Setup \(Intermod \(TOI\)\)](#)” on page 143.

Key Path: **MEASURE**

Remote Command:

Measurement Results Available		
Command	n	Results Returned
:CONFigure:TOI :INITiate:TOI	n/a	Not Applicable
:FETCh:TOI[n]? :MEASure:TOI[n]? :READ:TOI[n]?	n=1 or not specified	Returns 6 scalar results, in the following order. 1. The worst case Output Intercept Power value in dBm. 2. The worst case Output Intermod Point in Hz 3. The lower Output Intercept Power value in dBm 4. The lower Output Intermod Point in Hz 5. The upper Output Intercept Power value in dBm 6. The upper Output Intermod Point in Hz
	n=2	Returns 12 scalar results, in the following order. 1. The worst case Output Intermod Point value in Hz. 2. The worst case Output Intermod Power value in dBm. 3. The worst case Output Intercept Power value in dBm 4. The lower base frequency value in Hz 5. The lower base power value in dBm 6. The upper base frequency value in Hz 7. The upper base power value in dBm 8. The lower Output Intermod Point in Hz 9. The lower Output Intermod Power value in dBm 10. The lower Output Intercept Power value in dBm 11. The upper Output Intermod Point in Hz 12. The upper Output Intermod Power value in dBm 13. The upper Output Intercept Power value in dBm
:FETCh:TOI:IP3? :MEASure:TOI:IP3? :READ:TOI:IP3?	n=1 or not specified	Returns the worst case Output Intercept Power value in dBm.

Example: FETC:TOI2? or MEAS:TOI2? or READ:TOI2?
 FETC:TOI:IP3? or MEAS:TOI:IP3? or READ:TOI:IP3?

2.2.12 Spurious Emissions

The spurious emissions measurement identifies and determines the power level of spurious emissions in certain frequency bands. For more information see “[Meas Setup \(Spurious Emissions\)](#)” on page 197.

Key Path: **MEASURE**

History: Added with ESA firmware revision A.08.00

Remote Command:

Command	n	Results Returned
:CONFigure:SPURious :INITiate:SPURious	n/a	Not applicable
:FETCh:SPURious[n]? :MEASure:SPURious[n]? :READ:SPURious[n]?	n=1 (or not specified)	Returns a variable-length list of values containing detailed spur information. The total number of data values returned is (1 + 6x spurs), where x is the number of spurs identified. You can have up to 121 data entries if you have the maximum 20 spurs identified. The values returned are in the following order: 1. Number of spurs in items 2 through 6 in this list [Repeat the following for each spur] 2. Spur number 3. Range number in which spur was located (integer) 4. Frequency of spur (Hz) 5. Amplitude of spur (dBm) 6. Absolute limit (dBm) 7. Pass or Fail (1 0)
	n=2 through 21	Returns Detector 1 trace data values for the selected frequency range (where range number = n – 1). If the selected range is not active, then 9.91E37 is returned for each non-active trace data element.
	n=22	Returns the number of spurs found.
	n=23 through 42	Returns Detector 2 trace data values for the selected frequency range (where range number = n – 22). If selected range is not active, then 9.91E37 is returned for each trace data element.

Example: **MEAS:SPUR?**

2.2.13 Spectrum Emission Mask

Spectrum Emission Mask measurement includes the in-band and out-of-band spurious emissions. As it applies to W-CDMA (3GPP), this is the power contained in a specified frequency bandwidth at certain offsets relative to the total carrier power. It may also be expressed as a ratio of power spectral densities between the carrier and the specified offset frequency band. For WLAN, the reference power is taken as the peak PSD in the signal, and all offset results are also the peak PSD in that offset as opposed to the integrated power.

Offsets that are turned off (inactive) will return -999.0 when their results are queried over SCPI.

For more information see [“Meas Setup \(Spectrum Emissions Mask—SEM\)”](#) on page 171.

Key Path: **MEASURE**

History: Added with ESA firmware revision A.08.00

Remote Command:

Measurement Results Available		
Command / Condition	n	Results Returned
:CONFigure:SEMAsk :INITiate:SEMAsk	N/A	Not Applicable

One-Button Measurement Functions
MEASURE (Spectrum Analysis Mode)

Measurement Results Available (Continued)		
Command / Condition	n	Results Returned
:FETCh:SEMask[n]? :MEASure:SEMask[n]? :READ:SEMask[n]? Using Total Power Reference	n=1 (or not specified)	Returns 60 comma-separated scalar results, in the following order (70 when offset F is active): <ol style="list-style-type: none"> 1. Reserved for the future use, returns -999.0 2. Absolute power at the center frequency (reference) area (dBm) 3. Reserved for the future use, returns -999.0 4. Reserved for the future use, returns -999.0 5. Reserved for the future use, returns -999.0 6. Reserved for the future use, returns -999.0 7. Reserved for the future use, returns -999.0 8. Reserved for the future use, returns -999.0 9. Reserved for the future use, returns -999.0 10. Reserved for the future use, returns -999.0. 11. Relative power on the negative offset A (dBc) 12. Absolute power on the negative offset A (dBm) 13. Relative peak power on the negative offset A (dBc) 14. Absolute peak power on the negative offset A (dBm) 15. Peak frequency in the negative offset A (Hz) 16. Relative power on the positive offset A (dBc) 17. Absolute power on the positive offset A (dBm) 18. Relative peak power on the positive offset A (dBc) 19. Absolute peak power on the positive offset A (dBm) 20. Peak frequency in the positive offset A (Hz) 21. Relative power on the negative offset B (dBc) ... 59. Absolute peak power on the positive offset E (dBm) 60. Peak frequency in the positive offset E (Hz) <li style="padding-left: 20px;">If offset F is active: 61. Relative power on the negative offset F (dBc) 62. Absolute power on the negative offset F (dBm) 63. Relative peak power on the negative offset F (dBc) 64. Absolute peak power on the negative offset F (dBm) 65. Peak frequency in the negative offset F (Hz) 66. Relative power on the positive offset F (dBc) 67. Absolute power on the positive offset F (dBm) 68. Relative peak power on the positive offset F (dBc) 69. Absolute peak power on the positive offset F (dBm) 70. Peak frequency in the positive offset F (Hz)

Measurement Results Available (Continued)		
Command / Condition	n	Results Returned
Using Power Spectral Density Reference	(Continued) n=1 (or not specified)	<p>Returns 60 comma-separated scalar results, in the following order (70 when offset F is active):</p> <ol style="list-style-type: none"> 1. Reserved for the future use, returns –999.0 2. Absolute power at the center frequency (reference) area (dBm) 3. Reserved for the future use, returns –999.0 4. Reserved for the future use, returns –999.0 5. Peak frequency in the center frequency (reference) area (Hz) 6. Reserved for the future use, returns –999.0 7. Reserved for the future use, returns –999.0 8. Reserved for the future use, returns –999.0 9. Reserved for the future use, returns –999.0 10. Reserved for the future use, returns –999.0 11. Relative power on the negative offset A (dB). For WLAN Radio Std., returns –999.0. 12. Absolute power on the negative offset A (dBm/Hz). For WLAN Radio Std., returns –999.0. 13. Relative peak power on the negative offset A (dB) 14. Absolute peak power on the negative offset A (dBm/Hz) 15. Peak frequency in the negative offset A (Hz) 16. Relative power on the positive offset A (dB). For WLAN Radio Std., returns –999.0. 17. Absolute power on the positive offset A (dBm/Hz). For WLAN Radio Std., returns –999.0. 18. Relative peak power on the positive offset A (dB) 19. Absolute peak power on the positive offset A (dBm/Hz) 20. Peak frequency in the positive offset A (Hz) 21. Relative power on the negative offset B (dB). For WLAN Radio Std., returns –999.0. ... 59. Absolute peak power on the positive offset E (dBm/Hz) 60. Peak frequency in the positive offset E (Hz) If offset F is active: 61. Relative power on the negative offset F (dB). For WLAN Radio Std., returns –999.0. 62. Absolute power on the negative offset F (dBm/Hz). For WLAN Radio Std., returns –999.0. 63. Relative peak power on the negative offset F (dB) 64. Absolute peak power on the negative offset F (dBm/Hz) 65. Peak frequency in the negative offset F (Hz) 66. Relative power on the positive offset F (dB). For WLAN Radio Std., returns –999.0. 67. Absolute power on the positive offset F (dBm/Hz). For WLAN Radio Std., returns –999.0. 68. Relative peak power on the positive offset F (dB) 69. Absolute peak power on the positive offset F (dBm/Hz) 70. Peak frequency in the positive offset F (Hz)

One-Button Measurement Functions
MEASURE (Spectrum Analysis Mode)

Measurement Results Available (Continued)		
Command / Condition	n	Results Returned
	n=2	Returns the displayed frequency domain spectrum trace data separated by comma. The number of data points is determined by the setting of the trace points parameter.
	n=3	Returns the displayed frequency domain absolute limit trace data separated by comma. The number of data points is determined by the setting of the trace points parameter.
	n=4	Returns the displayed frequency domain relative limit trace data separated by comma. The number of data points is determined by the setting of the trace points parameter.
Using Total Power Reference	n=5	<p>Total Power Reference</p> <p>Returns 12 comma-separated scalar values (in dBm) of the absolute power of the segment frequencies (14 when offset F is active):</p> <ol style="list-style-type: none"> 1. Total power reference (dBm) 2. Reserved for the future use, returns -999.0 3. Negative offset frequency (A) 4. Positive offset frequency (A) ... 11. Negative offset frequency (E) 12. Positive offset frequency (E) <p>If offset F is active:</p> <ol style="list-style-type: none"> 13. Negative offset frequency (F) 14. Positive offset frequency (F)
Using Power Spectral Density Reference	n=5	<p>Power Spectral Density Reference</p> <p>Returns 12 comma-separated scalar values (in dBm/Hz) of the absolute power of the segment frequencies (14 when offset F is active):</p> <ol style="list-style-type: none"> 1. Total power reference (dBm/Hz) 2. Reserved for the future use, returns -999.0 3. Negative offset frequency (A) 4. Positive offset frequency (A) ... 11. Negative offset frequency (E) 12. Positive offset frequency (E) <p>If offset F is active:</p> <ol style="list-style-type: none"> 13. Negative offset frequency (F) 14. Positive offset frequency (F)

Measurement Results Available (Continued)		
Command / Condition	n	Results Returned
Using Total Power Reference	n=6	<p>Total Power Reference</p> <p>Returns 12 comma-separated scalar values (in dBc) of the power relative to the carrier at the segment frequencies (14 when offset F is active):</p> <ol style="list-style-type: none"> 1. Reserved for the future use, returns -999.0 2. Reserved for the future use, returns -999.0 3. Negative offset frequency (A) 4. Positive offset frequency (A) ... 11. Negative offset frequency (E) 12. Positive offset frequency (E) <p>If offset F is active:</p> <ol style="list-style-type: none"> 13. Negative offset frequency (F) 14. Positive offset frequency (F)
Using Power Spectral Density Reference	n=6	<p>Power Spectral Density Reference</p> <p>Returns 12 comma-separated scalar values (in dBc/Hz) of the power relative to the carrier at the segment frequencies (14 when offset F is active). Returns -999.0 for the offsets in WLAN standard:</p> <ol style="list-style-type: none"> 1. Reserved for the future use, returns -999.0 2. Reserved for the future use, returns -999.0 3. Negative offset frequency (A) 4. Positive offset frequency (A) ... 11. Negative offset frequency (E) 12. Positive offset frequency (E) <p>If offset F is active:</p> <ol style="list-style-type: none"> 13. Negative offset frequency (F) 14. Positive offset frequency (F)
	n=7	<p>Returns 12 comma-separated pass/fail test results (0 = passed, or 1 = failed) determined by testing the absolute power in each offset against the specified offset's absolute power limits (14 when offset F is active):</p> <ol style="list-style-type: none"> 1. Reserved for the future use, returns -999.0 2. Reserved for the future use, returns -999.0 3. Negative offset frequency (A) 4. Positive offset frequency (A) ... 11. Negative offset frequency (E) 12. Positive offset frequency (E) <p>If offset F is active:</p> <ol style="list-style-type: none"> 13. Negative offset frequency (F) 14. Positive offset frequency (F)

One-Button Measurement Functions
MEASURE (Spectrum Analysis Mode)

Measurement Results Available (Continued)		
Command / Condition	n	Results Returned
	n=8	<p>Returns 12 comma-separated scalar values of the pass/fail (0 = passed, or 1 = failed) results determined by testing the relative power in each offset against the specified offset's relative power limits (14 when offset F is active):</p> <ol style="list-style-type: none"> 1. Reserved for the future use, returns -999.0 2. Reserved for the future use, returns -999.0 3. Negative offset frequency (A) 4. Positive offset frequency (A) ... 11. Negative offset frequency (E) 12. Positive offset frequency (E) <p>If offset F is active:</p> <ol style="list-style-type: none"> 13. Negative offset frequency (F) 14. Positive offset frequency (F)
	n=9	<p>Returns 12 comma-separated scalar values of frequency (in Hz) that have peak power in each offset (14 when offset F is active):</p> <ol style="list-style-type: none"> 1. Reserved for the future use, returns -999.0 2. Reserved for the future use, returns -999.0 3. Negative offset frequency (A) 4. Positive offset frequency (A) ... 11. Negative offset frequency (E) 12. Positive offset frequency (E) <p>If offset F is active:</p> <ol style="list-style-type: none"> 13. Negative offset frequency (F) 14. Positive offset frequency (F)
	n=10	<p>Returns 12 comma-separated scalar values (in dBm) of the absolute peak power of the segment frequencies (14 when offset F is active):</p> <ol style="list-style-type: none"> 1. Reserved for the future use, returns -999.0 2. Reserved for the future use, returns -999.0 3. Negative offset frequency (A) 4. Positive offset frequency (A) ... 11. Negative offset frequency (E) 12. Positive offset frequency (E) <p>If offset F is active:</p> <ol style="list-style-type: none"> 13. Negative offset frequency (F) 14. Positive offset frequency (F)

Measurement Results Available (Continued)		
Command / Condition	n	Results Returned
	n=11	Returns 12 comma-separated scalar values (in dBc) of the peak power relative to the carrier at the segment frequencies (14 when offset F is active): 1. Reserved for the future use, returns -999.0 2. Reserved for the future use, returns -999.0 3. Negative offset frequency (A) 4. Positive offset frequency (A) ... 11. Negative offset frequency (E) 12. Positive offset frequency (E) If offset F is active: 13. Negative offset frequency (F) 14. Positive offset frequency (F)
	n=12	Returns the band power result when in WLAN standard. If not in WLAN standard the value returned will be -999.0
	n=13	Returns the number of failed trace points
	n=14	Returns the frequency and amplitude delta from the limit of each failed point

Example: FETC:SEM? or MEAS:SEM? or READ:SEM?

One-Button Measurement Functions
MEASURE (Spectrum Analysis Mode)

2.3 Meas Setup (Adjacent Channel Power—ACP)

If the adjacent channel power (ACP) measurement has been selected in the Measure menu of the spectrum analysis mode, this key displays the ACP measurement setup menu.

The adjacent channel power measurement measures the power that leaks into adjacent transmit channels. Depending on the radio standard chosen from the Mode Setup menu, this measurement can run in several different modes in order to measure different types of signals.

Key Path: Front-panel key

History: Added with PSA firmware revision A.02.00.

Remote Command:

There is no equivalent remote command.

2.3.1 Avg Number

Pressing **Avg Number** to **On** enables you to specify the number of measurements that will be averaged when calculating the measurement result. The average will be displayed at the end of each sweep. Setting **Avg Number** to **Off** disables the measurement averaging.

Key Path: **Meas Setup**

State Saved: Saved in instrument state.

Factory Preset: 10 / Off

Range: 1 to 1000

History: Added with PSA firmware revision A.02.00.

Remote Command:

```
[ :SENSe ] :ACPower:AVERage:COUNT <integer>
```

```
[ :SENSe ] :ACPower:AVERage:COUNT?
```

```
[ :SENSe ] :ACPower:AVERage [ :STATe ] OFF | ON | 0 | 1 turns the averaging on or off.
```

```
[ :SENSe ] :ACPower:AVERage [ :STATe ] ?
```

Example: ACP:AVER:COUN 10

 ACP:AVER:COUN?

 ACP:AVER OFF

 ACP:AVER?

2.3.2 Avg Mode

Press **Avg Mode** to select the type of termination control used for the averaging function as either **Exp** or **Repeat**. This determines the averaging action after the specified number of measurements (average count) is reached.

- **EXP** (Exponential Averaging mode)—When you set **Avg Mode** to **Exp**, each successive data acquisition after the average count is reached is exponentially weighted and combined with the existing average. Exponential averaging weights new data more than old data, which facilitates tracking of slow-changing signals. The average will be displayed at the end of each sweep.
- **Repeat**—When you set **Avg Mode** to **Repeat**, after reaching the average count, all previous result data is cleared and the average count is set back to 1.

Key Path: **Meas Setup**
State Saved: Saved in instrument state.
Factory Preset: EXPonential
History: Added with PSA firmware revision A.02.00.

Remote Command:

```
[ :SENSE ] :ACPower :AVERage :TCONrol EXPonential | REPEAT
```

```
[ :SENSE ] :ACPower :AVERage :TCONrol ?
```

Example: ACP:AVG:TCON EXP
ACP:AVG:TCON?

2.3.3 Chan Integ BW

Press **Chan Integ BW** to specify the range of integration used in calculating the power in the main channel.

Key Path: **Meas Setup**
Key Notes: If **RRC Filter** is on, the actual integration bandwidth used is the displayed integration bandwidth multiplied by (1 + **Filter Alpha**).
State Saved: Saved in instrument state.
Factory Preset: 2.0 MHz or as defined by the selected radio standard.
Default Terminator: Hz
Knob Increment: Span/50 if non-zero span.
RBW/100 if zero span.
Step Key
Increment: RBW if **CF Step** is set to **Auto** with zero span.
Span/10 if **CF Step** is set to **Auto** with non-zero span.

CF Step if **CF Step** is set to **Manual**.

Range: 300 Hz to 500 MHz. Depends on the adjacent-channel settings and the minimum and maximum analyzer span.

History: Added with PSA firmware revision A.02.00.

Remote Command:

```
[ :SENSe ] :ACPower :BANDwidth | BWIDth :INTEgration <freq>
```

```
[ :SENSe ] :ACPower :BANDwidth | BWIDth :INTEgration ?
```

Example: ACP:BWID:INT 5E6

ACP:BWID:INT?

2.3.4 Offset/Limits

Accesses menu keys that allow you to configure the offsets for the ACP measurement.

Key Path: **Meas Setup**

2.3.4.1 Offset

Selects the offset the menu keys will affect. Press **Offset** until the letter of the desired offset is underlined.

Key Path: **Meas Setup, Offset Setup**

State Saved: Saved in instrument state.

Factory Preset: A

History: Added with PSA firmware revision A.02.00.

Remote Command:

There is no remote command for this function.

2.3.4.2 Offset Freq or Edge Freq

Enables you to set the frequency difference from the center of the main channel to the center of the offset for a maximum of 6 offsets (labeled A-F). It also allows you to turn on/off the offsets that you want to measure.

NOTE This key label changes to **Edge Freq** when **IS-95C**, **cdma2000 MC-1X**, **cdma2000 MC-3X**, or **cdma2000 DS** is selected.

Key Path: **Meas Setup, Offset Setup**

One-Button Measurement Functions

Meas Setup (Adjacent Channel Power—ACP)

State Saved: Saved in instrument state.

Factory Preset: The following table shows the default array if no radio standard (**None**) is selected.

Offset	State	Frequency	Integ. BW
A	ON	3 MHz	2 MHz
B	OFF	0	2 MHz
C	OFF	0	2 MHz
D	OFF	0	2 MHz
E	OFF	0	2 MHz
F	OFF	0	2 MHz

Default Terminator: Hz

Knob Increment: Span/50 if non-zero span.

RBW/100 if zero span.

Step Key

Increment: RBW if **CF Step** is set to **Auto** with zero span.

Span/10 if **CF Step** is set to **Auto** with non-zero span.

CF Step if **CF Step** is set to **Manual**.

Range: PSA Only: 0 Hz to 500 MHz

History: Added with PSA firmware revision A.02.00.

Added with ESA firmware revision A.07.00.

Remote Command:

```
[ :SENSE ] :ACPower:OFFSet:LIST[:FREQUENCY]
<f_offset>,<f_offset>,<f_offset>,<f_offset>,<f_offset>,<f_offset>
```

```
[ :SENSe ] :ACPower:OFFSet:LIST[:FREQUENCY] ?
```

```
[ :SENSE ] :ACPower:OFFSet:LIST:STATE
OFF|ON|0|1, OFF|ON|0|1, OFF|ON|0|1, OFF|ON|0|1, OFF|ON|0|1, OFF|ON|0|1
```

```
[ :SENSe ] :ACPower:OFFSet:LIST:STATE?
```

Remote Command Notes: This command, along with commands [:SENSe]:ACPower:OFFSet:LIST:BANDwidth|BWIDth[:INTegration] and [:SENSe]:ACPower:OFFSet:LIST:STATe, are used to set the parameters for all of the offsets, up to six. The following table shows the values of these parameters if no radio standard (**None**) is selected.

Offset	State	Frequency	Integ. BW
A	ON	3 MHz	2 MHz
B	OFF	0	2 MHz
C	OFF	0	2 MHz
D	OFF	0	2 MHz
E	OFF	0	2 MHz
F	OFF	0	2 MHz

Example: Sending fewer than six parameters to one of these commands will leave the values of the unspecified offsets unchanged. If you do not send settings for all 6 offsets, it will set all the offsets that you specified, then it will set any remaining offsets to the same setting as the last offset that you sent.

```
ACP:OFFS:LIST 50 Hz,75 Hz,100 Hz,125 Hz,150 Hz,175 Hz
```

```
ACP:OFFS:LIST:STAT ON,ON,ON,OFF,OFF,OFF
```

For example, after the above command is sent, sending the command with only four parameters (ACP:OFFS:LIST:STAT ON,ON,ON,OFF) will result in the fifth and sixth offset remaining the same as the previous setting (OFF).

2.3.4.3 Ref BW

Sets the reference bandwidth (integration bandwidth) for each offset.

Key Path: **Meas Setup, Offset Setup**

State Saved: Saved in instrument state.

Factory Preset: 2 MHz, if no radio standard (**None**) is selected.

If a radio standard is selected, the default value is defined by the selected standard. This command, along with commands [:SENSe]:ACPower:OFFSet:LIST[:FREQuency] and [:SENSe]:ACPower:OFFSet:LIST:STATe are used to set an entire array of values. The following table shows the default array if no radio standard (**None**) is selected.

Offset	State	Frequency	Integ. BW
A	ON	3 MHz	2 MHz
B	OFF	0 Hz	2 MHz
C	OFF	0 Hz	2 MHz
D	OFF	0 Hz	2 MHz

One-Button Measurement Functions
Meas Setup (Adjacent Channel Power—ACP)

Offset	State	Frequency	Integ. BW
E	OFF	0 Hz	2 MHz
F	OFF	0 Hz	2 MHz

Default Terminator: Hz

Range: PSA Only: 300 Hz to 500 MHz

History: Added with PSA firmware revision A.02.00.

Added with ESA firmware revision A.07.00.

Remote Command:

[[:SENSE]:ACPower:OFFSet:LIST:BANDwidth|BWIDth[:INTEgration]
 <bw>, <bw>, <bw>, <bw>, <bw>, <bw>

[[:SENSe]:ACPower:OFFSet:LIST:BANDwidth|BWIDth[:INTEgration]?

Remote Command Notes: If a radio standard is selected, the default value is defined by the selected standard. This command, along with commands [[:SENSe]:ACPower:OFFSet:LIST[:FREQuency] and [[:SENSe]:ACPower:OFFSet:LIST:STATe are used to set an entire array of values. The following table shows the default array if no radio standard (**None**) is selected.

Offset	State	Frequency	Integ. BW
A	ON	3 MHz	2 MHz
B	OFF	0 Hz	2 MHz
C	OFF	0 Hz	2 MHz
D	OFF	0 Hz	2 MHz
E	OFF	0 Hz	2 MHz
F	OFF	0 Hz	2 MHz

Example: ACP:OFFS:LIST:BAND 50,50,50,50,50,50

ACP:OFFS:LIST:BAND?

2.3.4.4 Pos Offset Limit

Enables you to set the upper limit for the upper segment of the specified offset pair.

Key Path: **Meas Setup, Offset Setup**

State Saved: Saved in instrument state.

Factory Preset: 0.00 dB

Default Terminator: dB

Range: -200 dB to 200 dB

History: Added with PSA firmware revision A.02.00.
Added with ESA firmware revision A.08.00.

Remote Command:

```
:CALCulate:ACPower:OFFSet:LIST:LIMit:POSitive[:UPPer]:DATA  
<rel_power>,<rel_power>,<rel_power>,<rel_power>,<rel_power>,<rel_power>
```

```
:CALCulate:ACPower:OFFSet:LIST:LIMit:POSitive[:UPPer]:DATA?
```

Example: CALC:ACP:OFFS:LIST:LIM:POS:DATA 10,10,10,10,10,10

CALC:ACP:OFFS:LIST:LIM:POS:DATA?

2.3.4.5 Neg Offset Limit

Enables you to set the upper limit for the lower segment of the specified offset pair.

Key Path: **Meas Setup, Offset Setup**

State Saved: Saved in instrument state.

Factory Preset: 0.00 dB

Default Terminator: dB

Range: -200 dB to 200 dB

History: Added with PSA firmware revision A.02.00.
Added with ESA firmware revision A.08.00.

Remote Command:

```
:CALCulate:ACPower:OFFSet:LIST:LIMit:NEGative[:UPPer]:DATA  
<rel_power>,<rel_power>,<rel_power>,<rel_power>,<rel_power>,<rel_power>
```

```
:CALCulate:ACPower:OFFSet:LIST:LIMit:NEGative[:UPPer]:DATA?
```

Example: CALC:ACP:OFFS:LIST:LIM:NEG:DATA -50,-50,-50,-50,-50,-50

CALC:ACP:OFFS:LIST:LIM:NEG:DATA?

2.3.5 Meas Type

Accesses menu keys that allow you to configure the reference used to calculate ACP for the offsets.

2.3.5.1 Total Pwr Ref

Press **Total Pwr Ref** to specify the reference for the measurement, either **Total Pwr Ref** or **PSD Ref**. Relative values can be displayed referenced to either the total power (Total Pwr Ref) or the power spectral density (PSD Ref) measured in the main channel.

Key Path: **Meas Setup, Meas Type**

State Saved: Saved in instrument state.

Factory Preset: Total Pwr Ref

One-Button Measurement Functions

Meas Setup (Adjacent Channel Power—ACP)

History: Added with PSA firmware revision A.02.00.
Added with ESA firmware revision A.07.00.

Remote Command:

```
[ :SENSE ] :ACPower :TYPE PSDRef | TPreRef
```

```
[ :SENSE ] :ACPower :TYPE?
```

Example: ACP:TYPE PSDR
ACP:TYPE?

2.3.5.2 PSD Ref (PSA Only Setting)

Press **PSD Ref** to specify the units for the measurement, either dBm/Hz or dBm/MHz. Relative values can be displayed referenced either to dBm/Hz or dBm/MHz.

Key Path: **Meas Setup, Meas Type**

State Saved: Saved in instrument state.

Factory Preset: dBm/Hz

History: Added with PSA firmware revision A.06.00.

Not in ESA firmware

Remote Command:

```
:UNIT:ACPower:POWer:PSD DBMHZ | DBMMHZ
```

```
:UNIT:ACPower:POWer:PSD?
```

Example: UNIT:ACP:POW:PSD DBMMHZ

2.3.6 Optimize Ref Level

Sets the input attenuator and reference level to optimize the robustness of the measurement, in which it is free from errors due to input compression and log amp range limitations. The input attenuator setting will not necessarily give the optimum dynamic range, nor the optimum accuracy. No single setting can optimize both, and the optimum setting often depends on the signal characteristics.

NOTE There will always be a minimum of 2 dB for PSA or 5 dB for ESA of attenuation set to protect the analyzer input.

Key Path: **Meas Setup**

State Saved: Not saved.

History: Added with PSA firmware revision A.02.00.

Remote Command:

```
[ :SENSE ] :POWer [ :RF ] :RANGe:AUTO ONCE
```

Example: POW:RANG:AUTO ONCE

2.3.7 Method

Enables you to set the measurement method. The resolution bandwidth method is most useful for measuring cdmaOne and cdma2000 signals. The integration bandwidth method is preferred for other signals.

NOTE ESA Only:
 This key toggles to select either the integration bandwidth method (IBW) or the resolution bandwidth method (RBW).

Key Path:. **Meas Setup**
 State Saved:. Saved in instrument state.
 Factory Preset:. IBW
 History:. Added with PSA firmware revision A.02.00.
 Added with ESA firmware revision A.08.00.

Remote Command:

```
[ :SENSe ] :ACPower:METhod IBW|RBW|FAST
[ :SENSe ] :ACPower:METhod?
```

Remote Command Notes: . ESA Only: Fast is not an available option.

Example:. ACP:METH RBW
 ACP:METH?

2.3.7.1 IBW (PSA Only)

Sets the measurement control method to IBW.

Key Type:. 1 of N menu
 Key Path:. **Meas Setup, Method**
 History:. Modified with PSA firmware revision A.06.00

Remote Command:

```
Use [ :SENSe ] :ACPower:METhod See "Method" on page 91.
Example: ACP:METH IBW.
```

2.3.7.2 RBW (PSA Only)

Sets the measurement control method to RBW.

Key Type:. 1 of N menu

One-Button Measurement Functions
Meas Setup (Adjacent Channel Power—ACP)

Key Path: **Meas Setup, Method**

History: Modified with PSA firmware revision A.06.00

Remote Command:

Use [:SENSE]:ACPower:METHOD See “Method” on page 91.

Example: ACP:METH RBW.

2.3.7.3 Fast (PSA Only)

Sets the measurement control method to Fast. When this method is selected, the 5 point ACLR measurement method is used. The following parameters are configured to allow the measurement to be made. This method is only available for the 3GPP W-CDMA radio standard, this key will be disabled for all other radio standards.

NOTE The current function values are not saved when fast method is turned on. Most functions are disabled when Fast is selected.

Function	Value
Channel Integration BW	3.84 MHz
Offset State	On, On, Off, Off, Off, Off
Offset Frequency	5 MHz, 10 MHz, 0 Hz, 0Hz, 0 Hz
Ref BW	3.84 MHz
Meas Type	Total Pwr Ref
Opt Ref Lvl	Disabled
RRC Filter State	On
Filter Alpha	0.22 (T fixed at 1/3.84 MHz)
Noise Correction	Off
Radio Std ^a	3 GPP W-CDMA
Sweep Time ^{a, b}	6.2 ms
Sweep Time Mode ^a	Manual
Gate	Off
Sweep Points ^a	5
Trigger	Free Run
Detector	Average
Res BW	470 kHz
Res BW Mode	Manual

Function	Value
Video BW	5 MHz
Video BW Mode	Auto
Avg/VBW Type	Power
Avg/VBW Type Mode	Auto
Span	23.84 MHz
Span Zoom	Not Applicable
Full Span	Not Applicable
Zero Span	Not Applicable
Last Span	Not Applicable
Signal Track	Not Applicable

- a. This function is not disabled when **Fast** is selected.
- b. The maximum sweep time available is limited to 27 ms.

One-Button Measurement Functions

Meas Setup (Adjacent Channel Power—ACP)

Key Type: 1 of N menu
Key Path: **Meas Setup, Method**
History: Added with PSA firmware revision A.06.00

Remote Command:

Use [:SENSe]:ACPower:METhod See “Method” on page 91.

Example: ACP:METh FAST.

The following is an example of how to optimize speed.

```
FORM:DATA REAL,32
CAL:AUTO OFF
CONF:ACP
RAD:STAN W3GPP
SWE:POIN 601
ACP:AVER OFF
ACP:CARR:AUTO ON
ACP:FILT ON
ACP:FILT:ALPH 0.22
ACP:CORR:NOISE OFF
POW:RANG:AUTO ONCE
ACP:METh FAST
INIT:CONT OFF
DISP:ENAB OFF
INIT:ACP
```

2.3.8 Total Pwr Ref

Enables you to set the adjacent channel power reference to automatic or manual when **Meas Type** is set to **Total Pwr Ref**. When set to automatic, the carrier power result reflects the measured power value in the carrier. When set to manual, the last measured value is captured and held, or may be entered by the user. Relative values are displayed, referenced to the total power measured in the main channel.

Key Path: **Meas Setup**
State Saved: Saved in instrument state.
Factory Preset: Auto, Measured carrier power value
Terminators: dBm
Default Terminator: dBm
Range: -200 dBm to 200 dBm
History: Added with PSA firmware revision A.02.00.
Added with ESA firmware revision A.07.00.

Remote Command:

```
[ :SENSe] :ACPower:CARRier[:POWer]
[ :SENSe] :ACPower:CARRier:AUTO[:STATe] OFF|ON|0|1
[ :SENSe] :ACPower:CARRier:AUTO[:STATe]?
ESA Only: [ :SENSe] :ACPower:CARRier[:POWer] <ampl>
ESA Only: [ :SENSe] :ACPower:CARRier[:POWer]?
Example:      ACP:CARR:AUTO 0
              ACP:CARR:AUTO?
              ACP:CARR -100
              ACP:CARR?
```

2.3.9 PSD Ref

Enables you to set the power spectral density in the carrier (main channel) that will be used to compute the relative power spectral density values for the offsets when **Meas Type** is set to **PSD Ref**. When the PSD Ref state is set to Auto, this will be set to the measured carrier power spectral density.

Factory Preset: 0 dBm
 Terminators: dBm
 Default Terminator: dBm
 Step Key
 Increment: 1, 1.5, 2...
 Range: -999 dBm to +999 dBm
 History: Added with PSA firmware revision A.02.00.
 Added with ESA firmware revision A.07.01.

Remote Command:

```
[ :SENSe] :ACPower:CARRier:CPSD <dBm>
[ :SENSe] :ACPower:CARRier:CPSD?
```

Remote Command Notes: This function is only available when measurement type is set to PSD Ref, use the command [:SENSe]:ACPower:TYPE PSDRef to select the measurement type.

Example: ACP:CARR:CPSD 5

2.3.10 Limit Test

Pressing **Limit Test** turns the testing of the limit line on or off. When **Limit Test** is set to **On**, each offset is compared to its upper and lower offset limit. In those cases where the power exceeds the limit, a red “F” is placed next to the dBc result to indicate a failure. If there are any failures, the pass/fail indicator area show “FAIL” in red; if there are none, it shows “PASS” in green. Any offsets that are in the off state (see “[Offset Freq or Edge Freq](#)” on page 85) are not measured and their results will not be displayed on screen.

Key Path: **Meas Setup**
State Saved: Saved in instrument state.
Factory Preset: Off
History: Updated with PSA firmware revision A.03.00.
Added with PSA firmware revision A.02.00.
Updated with ESA firmware revision A.07.01.

Remote Command:

```
[ :SENSe] :ACPower:LIMit [ :STATe] OFF|ON|0|1
```

```
[ :SENSe] :ACPower:LIMit [ :STATe] ?
```

Example: ACP:LIM 1
ACP:LIM?

2.3.11 RRC Filter

Pressing **RRC Filter** turns the Root Raised Cosine filter on or off. This filter is the type specified in the NADC and 3GPP W-CDMA standards and is only available when **3GPP W-CDMA**, **NADC**, or **Tetra** is selected as the **Radio Std** from the **Mode Setup** menu. If **3GPP W-CDMA** is selected, the rolloff value (alpha) for the filter will be initially set to 0.22. T is set to 1/RefBW (default 260 ns). If **NADC** is selected, the rolloff will be initially set to 0.35. T is set to 1/RefBW (default 42 μs). If **TETRA** has been selected, the rolloff will be initially set to 0.35. T is set to 1/RefBW (default 55.6 μs). The rolloff value can be changed using **Filter Alpha**.

The filter is unavailable when the measurement method is set to **RBW**.

Key Path: **Meas Setup**
State Saved: Saved in instrument state.
Factory Preset: Off
History: Added with PSA firmware revision A.03.00.
Added with ESA firmware revision A.08.00.

Remote Command:

```
[ :SENSe] :ACPower:FILTer [ :RRC] [ :STATe] OFF|ON|0|1
[:SENSe]:ACPower:FILTer[:RRC][:STATe]?
```

Example: ACP:FILT 1
 ACP:FILT?

2.3.12 Filter Alpha

Press **Filter Alpha** to input the alpha value for the RRC Filter. This parameter is available when **3GPP W-CDMA**, **NADC**, or **TETRA** has been selected as the Radio Std. from the Mode Setup menu.

Key Path: **Meas Setup**
 State Saved: Saved in instrument state.
 Factory Preset: 0.22 when W-CDMA is selected, 0.35 when NADC or TETRA is selected, otherwise Off.
 Knob Increment: 0.01
 Step Key
 Increment: 0.1
 Range: 0.01 to 1.0
 History: Added with PSA firmware revision A.03.00.
 Added with ESA firmware revision A.09.00.

Remote Command:

```
[ :SENSe] :ACPower:FILTer [ :RRC] :ALPHA <number>
[:SENSe]:ACPower:FILTer[:RRC]:ALPHA?
```

Example: ACP:FILT:ALPH 0.22
 ACP:FILT:ALPH?

2.3.13 Noise Correction

Pressing **Noise Correction** turns noise correction on or off. When you set **Noise Corr** to **On**, a calibration of the noise floor is performed and used to correct for analyzer noise floor contribution to measurement levels, increasing dynamic range.

Noise Correction is unavailable if signal tracking is on, or when the radio standard is set to **NADC** or **PDC** when the measurement method is set to **RBW**.

Key Path: **Meas Setup**,
 State Saved: Saved in instrument state.
 Factory Preset: Off

One-Button Measurement Functions

Meas Setup (Adjacent Channel Power—ACP)

History: Added with PSA firmware revision A.02.00.
 Added with ESA firmware revision A.07.01.

Remote Command:

```
[ :SENSe ] :ACPower:CORRection:NOISe [ :AUTO ] OFF | ON | 0 | 1
```

```
[ :SENSe ] :ACPower:CORRection:NOISe [ :AUTO ] ?
```

Remote Command Notes: The noise correction feature is not available when the radio standard is set to NADC or PDC

Example: ACP:CORR:NOIS 1
 ACP:CORR:NOIS?

2.4 Trace/View (ACP Measurement)

If **ACP** has been selected in the Measure menu of the Spectrum Analysis mode, this key displays the appropriate **Trace/View** menu for the adjacent channel power (ACP) measurement.

Displays menu keys that enable you to set how trace information is stored and displayed.

Key Path: Front-panel key

Factory Preset: Spectrum

History: Added with PSA firmware revision A.02.00

Remote Command:

There is no equivalent remote command for this function.

2.4.1 Spectrum

Pressing **Spectrum** selects the spectral display of the measurement.

NOTE PSA Only: Spectrum is disabled when using the Fast Method.

Key Path: **Trace/View**

Factory Preset: Spectrum

History: Added with PSA firmware revision A.02.00

Added with ESA firmware revision A.07.00

Remote Command:

There is no remote command for this function.

2.4.2 Bar Graph

Pressing **Bars** turns the graphic bar display on or off.

Key Path: **Trace/View**

Factory Preset: Spectrum

History: Added with PSA firmware revision A.02.00

Added with ESA firmware revision A.07.00

Remote Command:

There is no remote command for this function.

2.4.3 Combined

Pressing **Combined** selects the measurement to be displayed as a bar graph and spectrum as shown below.

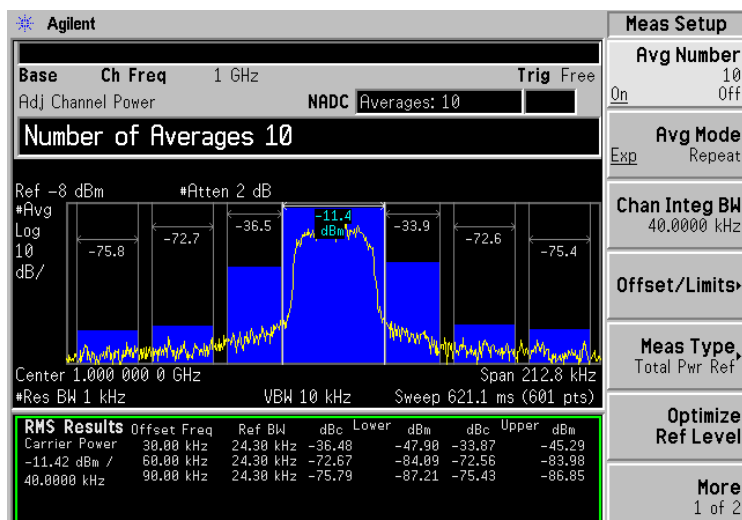

Key Path: **Trace/View**

Factory Preset: Spectrum

History: Added with PSA firmware revision A.02.00

Added with ESA firmware revision A.07.00

Remote Command:

There is no remote command for this function.

2.4.4 Combined View Units

Pressing **Combined View Units** selects the units (**dBc** or **dBm**) for the floating numeric displays when **Combined** is selected.

Key Path: **Trace/View**

Factory Preset: dBc

History: Added with PSA firmware revision A.02.00

Added with ESA firmware revision A.08.00

Remote Command:

There is no remote command for this function.

2.4.5 Trace

One-button measurements do not change this function. See Volume 1, *Core Spectrum Analyzer Functions User's and Programmer's Reference* guide for information about **Trace** and its lower-level functions.

2.5 Meas Setup (Burst Power)

When **Burst Power** has been selected in the Measure menu of the Spectrum Analysis Mode, this key displays the appropriate measurement setup menu.

The burst power measurement is an accurate method of determining the average power for the specified burst.

NOTE ESA Only: When selecting radio standards: NADC or PDC, the burst power measurement configures RF burst setup (**Trig, More, RF Burst Setup**) mode and level to accurately measure a signal with any combination of timeslots active. However, for signals with all timeslots active, set the parameters for RF burst setup as follows:

1. Select **RF Burst Setup. (Trig, RF Burst Setup)**
2. Set the trigger level mode to relative. (**Trigger Level (Rel)**)
3. Set the narrow pulse discriminator to off. (**Narrow Pulse Discriminator (Off)**)
4. Set the threshold level to -30 dB. (**Meas Setup, Threshold Lvl, $-3, 0, \text{dB}$**)

Key Path: Front-panel key

History: Added with PSA firmware revision A.02.00
 Added with ESA firmware revision A.07.00

Remote Command:

There is no equivalent remote command.

2.5.1 Avg Number

Press **Avg Number (On)** to specify the number of measurement averages used when calculating the measurement result. The average is displayed at the end of each sweep.

Key Path: **Meas Setup**

State Saved: Saved in instrument state.

Factory Preset: 10 averages / Off

Range: 1 to 1000

History: Added with PSA firmware revision A.02.00
 Added with ESA firmware revision A.07.00

One-Button Measurement Functions Meas Setup (Burst Power)

Remote Command:

```
[ :SENSe ] :BPOWer:AVERAge:COUNT <integer>
```

```
[ :SENSe ] :BPOWer:AVERAge:COUNT?
```

```
[ :SENSe ] :BPOWer:AVERAge [ :STATe ] OFF | ON | 0 | 1
```

```
[ :SENSe ] :BPOWer:AVERAge [ :STATe ] ?
```

Example: BPOW:AVER:COUN 100

 BPOW:AVER ON

2.5.2 Avg Mode

Press **Avg Mode** to select the type of termination control used for the averaging function to either **Exp** or **Repeat**. This determines the averaging action after the specified number of measurements (average count) is reached.

- **EXP** (Exponential Averaging mode)—When you set **Avg Mode** to **Exp**, each successive data acquisition after the average count is reached is exponentially weighted and combined with the existing average. Exponential averaging weights new data more than old data, which facilitates tracking of slow-changing signals. The average will be displayed at the end of each sweep.
- **Repeat**—When you set **Avg Mode** to **Repeat**, after reaching the average count, all previous result data is cleared and the average count is set back to 1.

Key Path: **Meas Setup**

State Saved: Saved in instrument state.

Factory Preset: EXPonential

Range: EXPonential|REPeat

History: Added with PSA firmware revision A.02.00.

 Added with ESA firmware revision A.07.00

Remote Command:

```
[ :SENSe ] :BPOWer:AVERAge:TCONrol EXPonential | REPEAT
```

```
[ :SENSe ] :BPOWer:AVERAge:TCONrol?
```

Example: BPOW:AVG:TCON EXP

 BPOW:AVG:TCON?

2.5.3 Average Type

Allows you to specify the type of result averaging to be performed.

- **Log** — Selects averaging that sums the trace data and divides by the number of data points.
- **RMS** — Selects averaging that converts trace data from dB to power units, then averages the power trace data. This selection requires more time to perform.

Key Path: **Meas Setup**

Factory Preset: RMS

Range: RMS or Log

History: Added with PSA firmware revision A.02.00
 Added with ESA firmware revision A.07.00

Remote Command:

```
[ :SENSe ] :BPOWer :AVERAge :TYPE LPOWer | POWer
```

```
[ :SENSe ] :BPOWer :AVERAge :TYPE?
```

Example: BPOW:AVG:TYP LPOWer to select Log type.
 BPOW:AVG:TYP?

2.5.4 Threshold Lvl

Enables you to set the level above which the mean carrier power calculation is based. The threshold level can be described in dB (**Rel**) or dBm (**Abs**).

Key Path: **Meas Setup**

Factory Preset: -30 dB

Terminators: dB or dBm

Default Terminator dB

Knob Increment: 0.1 dB/dBm

Step Key

Increment: 6 dB/dBm

Range: -60 dBm to 60 dBm (in absolute mode)
 -60 dB to 0 dB (in relative mode)

History: Added with PSA firmware revision A.02.00
 Added with ESA firmware revision A.07.00

One-Button Measurement Functions Meas Setup (Burst Power)

Remote Command:

```
[ :SENSe ] :BPOWer:THReshold <number>
```

```
[ :SENSe ] :BPOWer:THReshold?
```

```
[ :SENSe ] :BPOWer:THReshold:TYPE ABSolute|RELative
```

```
[ :SENSe ] :BPOWer:THReshold:TYPE?
```

Example: SENS:BPOW:THR:TYPE ABS

2.5.5 Meas Method

Allows you to select the measurement method.

- **Above Threshold Lvl** — Selects the user defined threshold level or default level (–3.00 dB) as the criteria in making the measurement.
- **Measured Burst Width** — This measurement method is not available for the following radio standards: IS-95, J-STD-008, cdma2000-SR1, cdma2000-SR3, W-DCMA 3GPP.

NOTE The measurements described above are those available in SA mode (see **MODE** key). Other measurements are available in other modes if an optional personality is installed.

Key Path: **Meas Setup**

Factory Preset: Above Threshold Lvl (THReshold)

Range: Measured Burst Width (BWIDth) to Above Threshold Lvl (THReshold)

History: Added with PSA firmware revision A.02.00

 Added with ESA firmware revision A.07.00

Remote Command:

```
[ :SENSe ] :BPOWer:METhod THReshold|BWIDth
```

```
[ :SENSe ] :BPOWer:METhod?
```

Example: BPOW:METh BWID to select burst width as the measurement method.

2.5.6 Burst Width

Sets the burst width parameter to automatic mode (**Auto**) or manual mode (**Man**).

- **Auto** — The burst width is automatically calculated based on the threshold level. For example, if the threshold level is set to 3 dB, the burst width will be the time between the two 3 dB points. This will update after each sweep, but before any results are calculated. Since the measurement only measures over the burst width, this will force a measurement between the 3 dB points.

- **Man** — The burst width used for computing the burst power is controlled by either entering it directly or as a percentage of the measured burst width. In the percentage case, the burst width is computed just once based on the most recent measured burst width. In either case, the burst width is centered on the observed burst in each measurement.

NOTE This key will be unavailable (grayed out) if **Meas Method** is set to **Above Threshold Lvl.**

Key Path: **Meas Setup**
Factory Preset: 542.77 μ s
Terminators: %, s, ms, μ s, ns (% from front panel only)
Default Terminator: seconds (s)
Knob Increment: 0.1 μ s
Step Key
Increment: 10 μ s
Range: 0.1 μ s to 2 ks
History: Added with PSA firmware revision A.02.00
Added with ESA firmware revision A.07.00

Remote Command:

```
[ :SENSe ] :BPOWer :BURSt :WIDTh <time>  
[ :SENSe ] :BPOWer :BURSt :WIDTh?  
[ :SENSe ] :BPOWer :BURSt :AUTO OFF | ON | 0 | 1  
[ :SENSe ] :BPOWer :BURSt :AUTO?
```

Remote Command Notes: Burst width cannot be set remotely as a percent of the current burst width. That functionality is available from the front panel, but the command must be sent with a time value.

Example: SENS:BPOW:BURST:AUTO ON

2.5.7 Optimize Ref Level

Sets the input attenuator and reference level to optimize the robustness of the measurement, which is its freedom from errors due to input compression and log amp range limitations.

NOTE There will always be a minimum of 2 dB for PSA or 5 dB for ESA of attenuation set to protect the analyzer input.

Key Path: **Meas Setup**

State Saved: Saved in instrument state.

Factory Preset: n/a

History: Added with PSA firmware revision A.02.00.

Added with ESA firmware revision A.07.00

Remote Command:

```
[ :SENSe ] :POWer [ :RF ] :RANGe :AUTO ONCE
```

Example: POW:RANG:AUTO ONCE

2.6 Trace/View (Burst Power)

If **Burst Power** has been selected in the Measure menu of the Spectrum Analysis mode, this key displays the appropriate **Trace/View** menu for the burst power measurement.

Displays menu keys that enable you to set how trace information is stored and displayed.

Key Path: Front-panel key

History: Added with ESA firmware revision A.08.00

Remote Command:

There is no remote command for this key.

2.6.1 RF Envelope

Press **RF Envelope** to view the measurement results as shown in the following figure. The results are updated after each sweep.

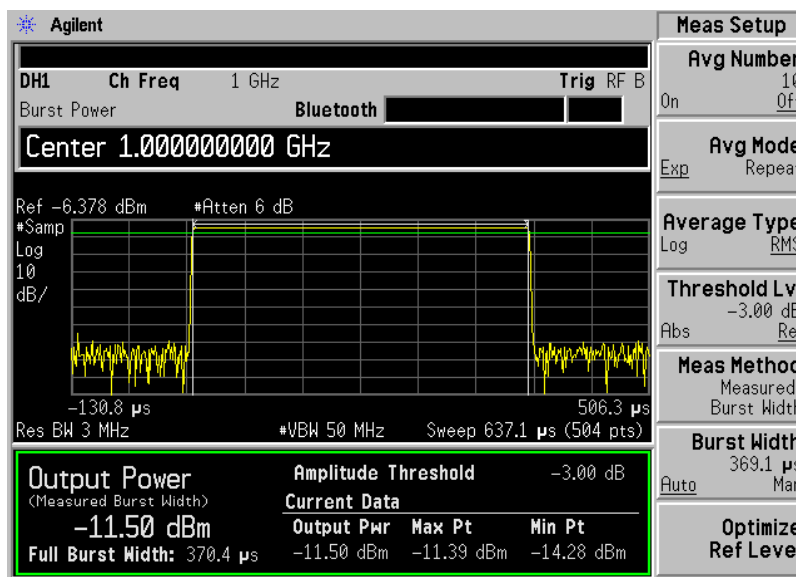

Key Path: **Trace/View**

History: Added with PSA firmware revision A.02.00
Added with ESA firmware revision A.08.00

2.6.2 Combined

Pressing **Combined** displays measurement results the same as RF Envelope, but has a blue bar between the markers to indicate the measured output power level. The actual measure output power is displayed at the bottom of the bar. Refer to the following figure.

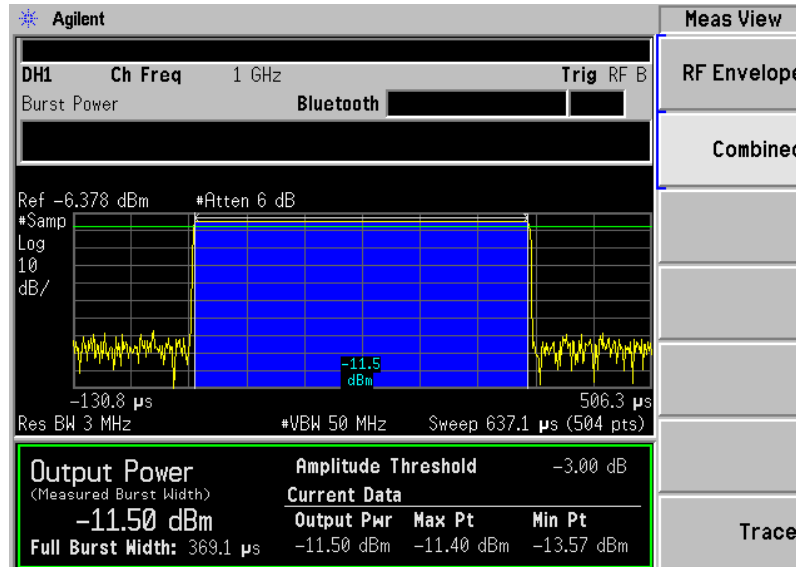

Key Path: **Trace/View**

History: Added with PSA firmware revision A.02.00

Added with ESA firmware revision A.08.00

2.6.3 Trace

One-button measurements do not change this function. See Volume 1, *Core Spectrum Analyzer Functions User's and Programmer's Reference* guide for information about **Trace** and its lower-level functions.

2.7 Meas Setup (Complementary Cumulative Distribution Function—CCDF)

When **Power Stat CCDF** has been selected in the Measure menu of the Spectrum Analysis mode, this key displays the appropriate measurement setup menu for the complementary cumulative distribution function (CCDF).

Power Complementary cumulative distribution function (CCDF) curves characterize the higher-level power of the signal. It provides the distribution of peak-to-average power ratios versus probability. A CCDF curve is defined by how much time the waveform spends at or above the specified power level. The percent of time the signal spends at or above this level defines the probability for that particular power level.

Key Path: Front-panel key
History: Added with PSA firmware revision A.02.00
Added with ESA firmware revision A.07.00.

Remote Command:

There is no equivalent remote command.

NOTE To make CCDF measurements on wide bandwidth signals up to 80 MHz, there is also a CCDF measurement in Basic mode if your instrument has Option 122 or 140.

2.7.1 Meas BW

Press **Meas BW** to set the measurement 3 dB bandwidth.

Key Path: **Meas Setup**
State Saved: Saved in instrument state.
Factory Preset: Defined by the radio standard selected.
Terminators: Hz, kHz, MHz, GHz
Knob Increment: Steps through available Res BW filters.
Step Key
Increment: Steps through available Res BW filters.
Range: PSA Only: 10 kHz to 5 MHz
ESA Only: 10 kHz to 8 MHz
History: Added with PSA firmware revision A.02.00
Added with ESA firmware revision A.07.00.

Remote Command:

```
[ :SENSe ] :PStatistic :BANDwidth | BWIDth <freq>
```

```
[ :SENSe ] :PStatistic :BANDwidth | BWIDth ?
```

Remote Command Notes: The entered value is rounded to the nearest Res BW filter frequency.

This command is coupled with the analyzer resolution bandwidth

Example: PST:BAND 10 or PST:BWID 10

PST:BAND? or PST:BWID?

2.7.2 Counts

Press **Counts** to set the accumulated number of sampling points for data acquisition. The range is 1 kpoints (kilopoint–1000 points) to 2.000000 Gpoints (Giga point– 10^9 point) with 1 kpoint resolution. While this key is activated, enter a value from the numeric keypad by terminating with one of the unit keys shown.

Key Path: **Meas Setup**

State Saved: Saved in instrument state.

Factory Preset: 1.00e5

Range: 1e3 to 1e9

History: Added with PSA firmware revision A.02.00
Added with ESA firmware revision A.07.00.

Remote Command:

```
[ :SENSe ] :PStatistic :COUNTs <integer>
```

```
[ :SENSe ] :PStatistic :COUNTs ?
```

Example: PST:COUN 1.0e6

PST:COUNT?

2.7.3 Meas Interval

Press **Meas Interval** to specify the time interval over which the measurement is made. The minimum setting is 100 μ s. The maximum setting depends on the measurement bandwidth setting but never exceeds 600 ms. The resolution is 1 μ s.

Key Path: **Meas Setup**

State Saved: Saved in instrument state.

Factory Preset: 1.0 ms

Default Terminator: s

Range: PSA Only: 100 μ s to 600 ms

ESA Only: 1 μ s minimum. Maximum value depends upon the measurement bandwidth. BW factor = 5 x meas BW or 10,000,000; whichever is less.

History: Added with PSA firmware revision A.02.00

Added with ESA firmware revision A.07.00.

Remote Command:

```
[ :SENSe ] :PStatistic :SWEep :TIME <time>
```

```
[ :SENSe ] :PStatistic :SWEep :TIME?
```

Example: PST:SWE:TIME 1.0e-3

PST:SWE:TIME?

2.7.4 Optimize Ref Level

PSA Only: Sets the input attenuator to optimize the robustness of the measurement, which is its freedom from errors due to input compression.

ESA Only: Sets the input attenuator and reference level to optimize the robustness of the measurement, which is its freedom from errors due to input compression and log amp range limitations.

NOTE There will always be a minimum of 2 dB for PSA or 5 dB for ESA of attenuation set to protect the analyzer input.

Key Path: **Meas Setup**

State Saved: Saved in instrument state.

History: Added with PSA firmware revision A.02.00
Added with ESA firmware revision A.07.00.

Remote Command:

[:SENSE] :POWer [:RF] :RANGe:AUTO ONCE

Example: POW:RANG:AUTO ONCE

2.8 Display (Complementary Cumulative Distribution Function—CCDF)

Press **Display** to access menu keys that allow you to configure parameters for the CCDF measurement.

NOTE The keys described below are measurement dependent. To access the display menus, for the CCDF measurement press **MEASURE, Power Stat CCDF**, then **Display**.

2.8.1 Full Screen

Expands the measurement window horizontally over the entire instrument display. Pressing any other key that results in a new menu cancels the full screen function.

Any error occurring turns full screen mode off.

Key Path: **Display**
State Saved: Not saved in state.
Factory Preset: Off
Factory Default Off
History: Added with PSA firmware revision A.02.00

2.8.2 Store Ref Trace

Press **Store Ref Trace** to copy the currently measured curve as the user-definable reference trace. The captured data will remain until the other mode is chosen. Pressing this key refreshes the reference trace.

Remote Command:

:CALCulate:PSTatistic:STORe:REFerence

Example: CALC:PST:STOR:REF

2.8.3 Ref Trace

Press **Ref Trace** to toggle the reference trace display function between on and off.

Key Path: **Display**
State Saved: Saved in instrument state.
Factory Preset: Off

Remote Command:

:DISPlay:PSTatistic:RTRace[:STATe] OFF|ON|0|1

:DISPlay:PSTatistic:RTRace[:STATe]?

Example: DISP:PST:RTR 1
 DISP:PST:RTR?

2.8.4 Gaussian Trace

Press **Gaussian Trace** to toggle the Gaussian trace display function between on and off.

Key Path: **Display**
State Saved: Saved in instrument state.
Factory Preset: On

Remote Command:

```
:DISPlay:PStatistic:GAUSSian[:STATe] OFF|ON|0|1  
:DISPlay:PStatistic:GAUSSian[:STATe]?
```

Example: DISP:PST:GAUS 1
 DISP:PST:GAUS?

2.8.5 Preferences

Displays the menu key that enables you to turn the graticule and annotation on or off.

Key Path: **Display**
State Saved: Saved in instrument state.
Factory Preset: No title
Fundamental
Units: N/A
History: Added with PSA firmware revision A.02.00

2.8.5.1 Graticule

Pressing **Graticule** turns the display graticules on and off.

Key Path: **Display, Preferences**
Factory Preset: On
Factory
Default: On
Terminators: Enter
History: Added with PSA firmware revision A.02.00

2.9 Marker (Complementary Cumulative Distribution Function—CCDF)

Displays the Marker control menu for the CCDF measurement. All markers are off until either **Normal** or **Delta** is pressed. There are three control modes for the markers:

- **Normal (POSition)** - A single marker placed at the 0 dB point of the selected value of **Marker Trace** that can be moved to any point on the trace.
- **Delta (DELTA)** - Places the selected marker and the next marker at the position of the previous marker on the specified trace (selected by pressing **Marker Trace**). The next marker is the reference marker (set to normal) and the selected marker is a moveable marker (delta) that you can place at any point on the trace. The difference between the selected marker and the reference marker is displayed.
- **Off (OFF)** - Turns off the active marker.

Key Path: Front-panel key

State Saved: The control mode for each marker, as well as the position of each marker, is saved in instrument state.

Factory Preset: All Off.

History: Added with PSA firmware revision A.02.00
Added with ESA firmware revision A.07.00

Remote Command:

There is no equivalent remote command. These commands control the three marker modes. Refer to the Normal, Delta, and Off key descriptions for additional information.

```
:CALCulate:PStatistic:MARKer [1] | 2 | 3 | 4 :MODE NORMal | DELTa | OFF
```

```
:CALCulate:PStatistic:MARKer [1] | 2 | 3 | 4 :MODE?
```

Remote Command Notes: See also the marker positioning commands:

[“Marker X Position \(Remote Command Only\)” on page 119](#)

[“Marker Y Position \(Remote Command Only\)” on page 120](#)

[“Marker Maximum and Minimum \(Remote Command Only\)” on page 120](#)

Example: `CALC:PST:MARK:MODE DELT` activates a delta marker (marker 1) at the 0 dB point of your measurement (yellow line).

2.9.1 Select Marker

Selects one of the four possible markers. Once a marker is selected, it can be set to any of the control modes **Normal**, **Delta**, or **Off**.

Key Path: **Marker** (after **MEASURE**, **Power Stat CCDF** is selected.)
State Saved: The number of the selected marker is saved in instrument state.
Factory Preset: Marker 1
History: Added with ESA firmware revision A.07.00

Remote Command:

```
:CALCulate:PStatistic:MARKer[1]|2|3|4[:STATe] OFF|ON|0|1  
:CALCulate:PStatistic:MARKer[1]|2|3|4[:STATe]?
```

Sets or queries the state of a marker. Setting a marker to state ON or 1 selects that marker. Setting a marker which is OFF to state ON or 1 puts it in **Normal** mode and places it at the center of the display. Setting a marker to state OFF or 0 selects that marker and turns it off. The response to the query will be 0 if OFF, 1 if ON.

Example: `CALC:PST:MARK2 ON` selects marker 2.
`CALC:PST:MARK:STAT ON` will not modify a marker that is already on.

2.9.2 Normal

Sets the control mode for the selected marker to **Normal**. If the marker is off, a single marker is activated at the 0 dB point of the selected trace (see “[Marker Trace](#)” on page 118). You can then adjust the selected marker using the numeric keypad, knob, or \uparrow \downarrow keys.

Key Path: **Marker** (after **MEASURE**, **Power Stat CCDF** is selected.)
Factory Preset: Off
History: Added with ESA firmware revision A.07.00

Remote Command:

See Volume 1, *Core Spectrum Analyzer Functions User’s and Programmer’s Reference* guide.

Example: `CALC:PST:MARK:MODE NORM` selects marker 1 and sets it to **Normal**.

2.9.3 Delta

Sets the control mode for the selected marker to **Delta**. In Delta mode the display shows the difference between the active (**Delta**) marker and a reference marker. When Delta mode is selected the reference marker is placed at the current marker position, unless the marker was **OFF**, in which case both the active marker and the reference marker are placed at 0 dB point of the selected trace (see “[Marker Trace](#)” on page 118). You can adjust the trace point of the active delta marker. Annotation in the active function block and in the upper-right corner of the display indicates the power ratio (dB) difference and probability (percentage) difference of the two markers.

Key Path: **Marker** (after **MEASURE, Power Stat CCDF** is selected.)

History: Added with ESA firmware revision A.07.00

Remote Command:

See Volume 1, *Core Spectrum Analyzer Functions User’s and Programmer’s Reference* guide.

Example: `CALC:PST:MARK3:MODE DELT` selects marker 3 as a delta marker and places a reference marker at the 0 dB point on the specified trace (see “[Marker Trace](#)” on page 118). If marker 3 is OFF it places both the active and the reference markers at the 0 dB point of the specified trace.

2.9.4 Off

Turns off the selected marker. In addition, **Off** also turns off functions related to the selected marker.

Key Path: **Marker** (after **MEASURE, Power Stat CCDF** is selected.)

History: Added with ESA firmware revision A.07.00

Remote Command:

See Volume 1, *Core Spectrum Analyzer Functions User’s and Programmer’s Reference* guide.

Example:

`CALC:PST:MARK3:STAT OFF` selects marker 3 and sets it to **Off**.

2.9.5 Marker Trace

Chooses which trace the selected marker will be placed on. You can pick **Measured**, **Gaussian**, or **Reference**.

Key Path: **Marker** (after **MEASURE**, **Power Stat CCDF** is selected.)
State Saved: The **Marker Trace** for each marker is saved in instrument state.
Factory Preset: Measured
History: Added with ESA firmware revision A.07.00

Remote Command:

```
:CALCulate:PStatistic:MARKer[1]|2|3|4:TRACe MEASured|GAUSSian|REFerence
```

Puts the marker on the specified trace.

```
:CALCulate:PStatistic:MARKer[1]|2|3|4:TRACe?
```

The query returns the type of the trace on which the marker currently resides.

Example: `CALC:PST:MARK1:TRAC GAUSSian` places marker 1 on the Gaussian trace.

2.9.6 Marker All Off

Turns off all markers.

NOTE Selecting any measurement (including **Meas Off**) under **Measure**, turns off the marker table.

Key Path: **Marker** (after **MEASURE**, **Power Stat CCDF** is selected.)
History: Added with ESA firmware revision A.07.00

Remote Command:

```
:CALCulate:PStatistic:MARKer[1]|2|3|4:AOFF
```

Example: `CALC:PST:MARK:AOFF` turns off all markers.

2.9.7 Marker X Position (Remote Command Only)

Sets the marker X position (horizontal) to a specified point on the X axis in the current X-axis units (dB). If the value chosen would place the marker off screen, the marker will be placed at the left or right side of the display, on the specified trace (see “[Marker Trace](#)” on page 118). If the marker is off, this command has no effect.

Key Path:	Marker
Key Notes:	When a marker is active, you may use the knob, numeric keypad, or $\uparrow\downarrow$ keys to specify the horizontal location of the marker.
Terminators:	dB
Step Key Increment:	1 dB
Range:	0 to 50 dB
History:	Added with PSA firmware revision A.02.00 Added with ESA firmware revision A.07.00

Remote Command:

```
:CALCulate:PStatistic:MARKer[1]|2|3|4:X <dB>
```

Sets the marker X position in the current X-axis units (dB).

```
:CALCulate:PStatistic:MARKer[1]|2|3|4:X?
```

Queries the marker X position in the current x-axis units. For the response to be valid, the marker must be on.

```
:CALCulate:PStatistic:MARKer[1]|2|3|4:X:POSition <dB>
```

```
:CALCulate:PStatistic:MARKer[1]|2|3|4:X:POSition?
```

This defines marker X position in display points from 0 to 50 dB.

Example: `CALC:PST:MARK:X 30 dB` activates a normal marker (marker 1) at the 30 dB location on the specified trace (see “[Marker Trace](#)” on page 118).

`CALC:PST:MARK2:X:POS 10` selects marker 2 and moves it to 1 dB location on the specified trace.

2.9.8 Marker Y Position (Remote Command Only)

Displays the marker Y position (vertical) of the specified trace (see “Marker Trace” on page 118) in the current Y-axis units (percent).

History: Added with PSA firmware revision A.02.00
 Added with ESA firmware revision A.07.00

Remote Command:

```
:CALCulate:PStatistic:MARKer[1]|2|3|4:Y?
```

Queries the marker Y value or delta in the current y axis units. The marker must be **ON** for the response to be valid.

Example: CALC:PST:MARK1:Y?

2.9.9 Marker Maximum and Minimum (Remote Command Only)

Moves the marker to the maximum or minimum detected amplitude value on the display. If the marker is off, this command has no effect.

History: Added with PSA firmware revision A.02.00
 Added with ESA firmware revision A.07.00

Remote Command:

```
:CALCulate:PStatistic:MARKer[1]|2|3|4:MAXimum
```

```
:CALCulate:PStatistic:MARKer[1]|2|3|4:MINimum
```

Example: CALC:PST:MARK:MAX
 CALC:PST:MARK3:MIN

2.10 SPAN X Scale (Complementary Cumulative Distribution Function—CCDF)

Activates the Span function for the CCDF measurement and displays the menu of span functions.

Key Path: Front-panel key

State Saved: Saved in Instrument State

Remote Command:

See the [Scale/Div](#) command below.

2.10.1 Scale/Div

Allows you to enter a numeric value to change the horizontal display sensitivity by setting the decibel units per horizontal graticule division.

Key Path: **MEASURE, Power Stat CCDF, SPAN X Scale**

State Saved: Saved in instrument state.

Factory Preset: 2.0 dB

Default Terminator: dB

Range: 0.1 to 20.00 dB with 0.01 dB resolution

Remote Command:

```
:DISPlay:PStatistic:XSCale <rel_ampl>
```

```
:DISPlay:PStatistic:XSCale?
```

Example DISP:PST:XSC 10 dB

 DISP:PST:XSC?

One-Button Measurement Functions
SPAN X Scale (Complementary Cumulative Distribution Function—CCDF)

2.11 Meas Setup (Channel Power—CHP)

When the channel power measurement has been selected in the Measure menu of the Spectrum Analysis Mode, this key displays the appropriate measurement setup menu.

The Channel Power measurement measures the power and power spectral density in the channel bandwidth that you specify. One marker pair on the display indicates the edges of the channel bandwidth. The center frequency, reference level, and channel bandwidth must be set by the user.

Key Path: Front-panel key

Dependencies/

Couplings: Menu changes depending on the Mode and Measurement selected.

State Saved: Not saved.

History: Added with PSA firmware revision A.02.00

Remote Command:

There is no equivalent remote command.

2.11.1 Avg Number

To specify the number of measurement averages used when calculating the measurement result set **Avg Number** to **On**. The average will be displayed at the end of each sweep. Setting **Avg Number** to **Off** disables measurement averaging.

Key Path: **Meas Setup**

State Saved: Saved in instrument state.

Factory Preset: 10 averages/ Off

Knob Increment: 1

Step Key

Increment: 1

Range: 1 to 1000

Remote Command:

```
[ :SENSe ] :CHPower:AVERAge:COUNT <integer>
```

```
[ :SENSe ] :CHPower:AVERAge:COUNT?
```

```
[ :SENSe ] :CHPower:AVERAge [ :STATe ] OFF | ON | 0 | 1
```

```
[ :SENSe ] :CHPower:AVERAge [ :STATe ] ?
```

One-Button Measurement Functions Meas Setup (Channel Power—CHP)

Example: CHP: AVER: COUN 10
 CHP: AVER: COUN?
 CHP: AVER OFF
 CHP: AVER?

2.11.2 Avg Mode

Press **Avg Mode** to select the type of termination control used for the averaging function to either **Exp** or **Repeat**. This determines the averaging action after the specified number of measurements (average count) is reached.

- **EXP** (Exponential Averaging mode)—When you set **Avg Mode** to **Exp**, each successive data acquisition after the average count is reached is exponentially weighted and combined with the existing average. Exponential averaging weights new data more than old data, which facilitates tracking of slow-changing signals. The average will be displayed at the end of each sweep.
- **Repeat**—When you set **Avg Mode** to **Repeat**, after reaching the average count, all previous result data is cleared and the average count is set back to 1.

Key Path: **Meas Setup**
State Saved: Saved in instrument state.
Factory Preset: EXponential

Remote Command:

```
[ :SENSE ] :CHPower: AVERage: TCONrol EXPonential | REPEAT
```

```
[ :SENSE ] :CHPower: AVERage: TCONrol ?
```

Example: CHP: AVG: TCON EXP
 CHP: AVG: TCON?

2.11.3 Integ BW

Press **Integ BW** to specify the range of integration used in calculating the power in the channel. The integration bandwidth is displayed on the trace as two markers connected by an arrow. Be sure the **Span** of the instrument is set between 1 and 10 times the integration bandwidth.

Key Path: **Meas Setup**
Key Notes: If **RRC Filter** is on, the actual integration bandwidth used is the displayed integration bandwidth multiplied by (1 + “Filter Alpha”).
State Saved: Saved in instrument state.

Factory Preset: 2 MHz, or as defined by the selected radio standard.

Terminators: GHz, MHz, kHz, Hz

Default Terminator: Hz

Knob Increment: 1%

Step Key

Increment: 1, 1.5, 2, 3, 5, 7.5, 10...

Range: 100 Hz to maximum span supported by your analyzer.

Remote Command:

```
[ :SENSe ] :CHPower :BANDwidth | BWIDth :INTEgration <freq>
```

```
[ :SENSe ] :CHPower :BANDwidth | BWIDth :INTEgration ?
```

Example: CHP:BAND:INT 1 MHz

CHP:BAND:INT?

2.11.4 Chan Pwr Span

Press **Chan Pwr Span** to set the analyzer span for the channel power measurement. When the **RRC Filter** is set to **On**, the lower limit for the span is $(1 + \alpha) \times \text{Integration BW}$.

Key Path: **Meas Setup**

State Saved: Saved in instrument state.

Factory Preset: 3 MHz, or as defined by the selected radio standard.

Default Terminator: Hz

Knob Increment: 1, 1.5, 2, 3, 5, 7.5, 10...

Step Key

Increment: 1%

Range: Current integration bandwidth to 10 times the integration bandwidth or span of your analyzer.

Remote Command:

```
[ :SENSe ] :CHPower :FREQuency :SPAN <freq>
```

```
[ :SENSe ] :CHPower :FREQuency :SPAN ?
```

Example: CHP:FREQ:SPAN 2 MHz

CHP:FREQ:SPAN?

2.11.5 PSD Unit (PSA Only Setting)

Press **PSD Ref** to specify the units for the measurement, either dBm/Hz or dBm/MHz.

Key Path: **Meas Setup**

State Saved: Saved in instrument state.

Factory Preset: dBm/Hz

Not in ESA firmware

Remote Command:

```
:UNIT:CHPower:POWer:PSD DBMHZ|DBMMHZ
```

```
:UNIT:CHPower:POWer:PSD?
```

Example: UNIT:CHP:POW:PSD DBMMHZ

2.11.6 Optimize Ref Level

Sets the input attenuator and reference level to optimize the robustness of the measurement, which is its freedom from errors due to input compression and log amp range limitations.

NOTE There will always be a minimum of 2 dB for PSA or 5 dB for ESA of attenuation set to protect the analyzer input.

Key Path: **Meas Setup**

State Saved: Not saved.

Remote Command:

```
[ :SENSE ] :POWer [ :RF ] :RANGe:AUTO ONCE
```

Example: POW:RANG:AUTO ONCE

2.11.7 RRC Filter

Pressing **RRC Filter** turns the Root Raised Cosine filter on or off. This filter is the type specified in the TETRA and 3GPP W-CDMA standards. This parameter is only available when either **3GPP W-CDMA** or **TETRA** has been selected as the **Radio Std** from the **Mode Setup** menu. If **3GPP W-CDMA** is selected, the rolloff value (alpha) for the filter will be initially set to 0.22. T is set to 1/RefBW (default 260 ns). If **TETRA** is selected, the rolloff will be initially set to 0.35. T is set to 1/RefBW (default 55.56 µs). The rolloff value can be changed using **Filter Alpha**.

Key Path: **Meas Setup**

State Saved: Saved in instrument state.

Factory Preset: Off

History: Added with PSA firmware revision A.03.00.
 Added with ESA firmware revision A.09.00.

Remote Command:

[:SENSe] :CHPower:FILTer [:RRC] [:STATe] OFF|ON|0|1

[:SENSe] :CHPower:FILTer [:RRC] [:STATe] ?

Example: CHP:FILT 1

 CHP:FILT?

2.11.8 Filter Alpha

Press **RRC Filter** to input the alpha value for the RRC Filter. This parameter is only available when either **3GPP W-CDMA** or **TETRA** has been selected as the Radio Std. from the Mode Setup menu.

Key Path: **Meas Setup**

State Saved: Saved in instrument state.

Factory Preset: 0.22 when W-CDMA is selected, 0.35 for TETRA, otherwise Off.

Knob Increment: 0.01

Step Key

Increment: 0.1

Range: 0.01 to 1.0

History: Added with PSA firmware revision A.03.00.

Added with ESA firmware revision A.09.00.

Remote Command:

```
[ :SENSe ] :CHPower :FILTer [ :RRC ] :ALPHA <number>
```

```
[ :SENSe ] :CHPower :FILTer [ :RRC ] :ALPHA?
```

Example: CHP:FILT:ALPH 0.22

CHP:FILT:ALPH?

2.12 Meas Setup (Harmonic Distortion)

When the harmonic distortion measurement has been selected in the Measure menu of the Spectrum Analysis Mode, this key displays the appropriate measurement setup menu.

Key Path: Front-Panel key

Dependencies/

Couplings: This measurement is not available when external mixing has been selected.

Saved State: Not saved.

2.12.1 Avg Number

Press **Avg Number (On)** to specify the number of measurement averages used when calculating the measurement result. The average will be displayed at the end of each sweep.

Key Path: **Meas Setup**

State Saved: Saved in instrument state.

Factory Preset: 10 averages / Off

Range: 1 to 1000

Remote Command:

```
[ :SENSe ] :HARMonics :AVERAge :COUNT <integer>
```

```
[ :SENSe ] :HARMonics :AVERAge :COUNT?
```

```
[ :SENSe ] :HARMonics :AVERAge [ :STATe ] OFF | ON | 0 | 1
```

```
[ :SENSe ] :HARMonics :AVERAge [ :STATe ] ?
```

Example: HARM:AVER:COUN 100

HARM:AVER ON

2.12.2 Avg Mode

Press **Avg Mode** to select the type of termination control used for the averaging function to either **Exp** or **Repeat**. This determines the averaging action after the specified number of measurements (average count) is reached.

- **EXP** (Exponential Averaging mode)—When you set **Avg Mode** to **Exp**, each successive data acquisition after the average count is reached is exponentially weighted and combined with the existing average. Exponential averaging weights new data more than old data, which facilitates tracking of slow-changing signals. The average will be displayed at the end of each sweep.
- **Repeat**—When you set **Avg Mode** to **Repeat**, after reaching the average count, all previous result data is cleared and the average count is set back to 1.

Key Path: **Meas Setup**
State Saved: Saved in instrument state.
Factory Preset: EXPonential
Range: EXPonential|REPeat
History: Added with PSA firmware revision A.02.00.

Remote Command:

```
[ :SENSE ] :HARMonics:AVERAge:TCONrol EXPonential | REPeat
```

```
[ :SENSe ] :HARMonics:AVERAge:TCONrol?
```

Example: HARM:AVG:TCON EXP
HARM:AVG:TCON?

2.12.3 Harmonics

Harmonics indicates the number of harmonics to measure before computing the total harmonic distortion. The minimum number is 2 (only the fundamental and second harmonic will be measured). The maximum number is 10.

Key Path: **Meas Setup**
State Saved: Saved in instrument state.
Factory Preset: 10
Range: 2 to 10

Remote Command:

```
[ :SENSE ] :HARMonics:NUMBer <integer>
```

```
[ :SENSe ] :HARMonics:NUMBer?
```

Example: HARM:NUMB 5

2.12.4 ST/Harmonic

Sets the sweep time used to measure each harmonic. The value is set to 200 divided by the resolution bandwidth, or 10 ms, whichever is greater when the measurement is started. This sweep time is used only for measuring harmonics. The analyzer sweep time before the measurement was started is used for finding the fundamental.

Key Path: **Meas Setup**

State Saved: Saved in instrument state.

Factory Preset: 10 ms / Auto

Default Terminator: seconds

Range: 10 ms to maximum sweep time of the analyzer

Remote Command:

```
[ :SENSe ] :HARMonics :SWEeptime :STATe OFF | ON | 0 | 1
```

```
[ :SENSe ] :HARMonics :SWEeptime :STATe ?
```

```
[ :SENSe ] :HARMonics :SWEeptime <time>
```

```
[ :SENSe ] :HARMonics :SWEeptime ?
```

Remote Command Notes: ON is equal to automatic (Auto). OFF is equal to manual (Man).

Example: HARM:SWE:STAT OFF

HARM:SWE 100 ms

2.12.5 Range Table (On/Off)

Press **Range Table** to specify whether the range table is to be used or not. When **Range Table** is set to **Off** the harmonics are measured. When **Range Table** is set to On the first active range is considered to be the fundamental and the subsequent active ranges are used as the harmonics. At least two ranges must be active if **Range Table** is set to **On**.

Key Path: **Meas Setup**

Factory Preset: See [Table 2-1 on page 133](#).

Range: Off|On

History: Added with PSA firmware revision A.03.00

Added with ESA firmware revision A.09.00

Remote Command:

```
[ :SENSe ] :HARMonics :RTABle :STATe OFF | ON | 0 | 1
```

```
[ :SENSe ] :HARMonics :RTABle :STATe ?
```

Example: HARM:RTAB:STAT OFF

2.12.6 Range Table

Enables you to enter the settings for up to 10 ranges, either using the instrument front panel keys or remotely. Upon entering the range table, the measurement stops, then the analyzer is set to a constantly sweeping state. The analyzer is then set to the current values for range 1 (whether range 1 is on or off). If a range is currently off, the values in the range table for that range are replaced with --- (see Range 5 in the illustration) to indicate this range is currently inactive.

Range	Center Freq	Span	Res BW	Video BW	Sweep Time
1	50.00 MHz	0.000 Hz	100.0 kHz	100.0 kHz	10.00 ms
2	100.0 MHz	0.000 Hz	100.0 kHz	2.000 kHz	10.00 ms
3	150.0 MHz	0.000 Hz	100.0 kHz	2.000 kHz	10.00 ms
4	200.0 MHz	0.000 Hz	100.0 kHz	2.000 kHz	10.00 ms
5	---	---	---	---	---

NOTE You can edit the range table at anytime by pressing any front-panel key except the following: **Esc**, **System**, **File**, **Save**, **Print Setup**, **Print**, **Marker**, **Peak Search**, **Freq Count**, **Next Marker**, **Next Window**, or **Zoom**.

- Key Path: **Meas Setup**
- Saved State: All values for all ranges are saved in instrument state.
- Factory Preset: For each range, the following settings are selected: **Range State(On)**, **Zero Span**, **Res BW Mode(Man)**, **Video BW(Man)** is set to 2 kHz, and **Sweep Time Mode(Auto)** is set to 10 ms. [Table 2-1, “Range Table Default Settings,” on page 133](#) defines the other default parameter settings for the measurement.

Table 2-1 Range Table Default Settings

Range	Center Freq (GHz)	Res BW (kHz)
1	1.000	100.0
2	2.000	200.0
3	3.000	300.0
4	4.000	430.0
5	5.000	510.0
6	6.000	620.0
7	7.000	750.0
8	8.000	820.0
9	9.000	910.0
10	10.00	1000.0

History: Added with PSA firmware revision A.03.00
 Added with ESA firmware revision A.09.00

Remote Command:

There is no equivalent remote command.

2.12.6.1 Range

Selects a range and updates the values on the other **Range Table** keys so that they reflect the settings for the selected range. If **Range** is set to **On** it is used as part of the measurement; when set to **Off** it is excluded. A range is made up of the next parameters.

Key Path: **Meas Setup, Range Table**

Factory Preset: See [Table 2-1 on page 133](#).

Range: Off|On

Remote Command:

This parameter can send up to 10 values. The location in the list sent corresponds to the range the value is associated with. Missing values are not permitted. For example, if you want to change values 2 and 6, you must send all values up to 6. Subsequent values remain as they were.

```
[ :SENSe ] :HARMonics:RANGe [ :LIST ] :STATe OFF | ON | 0 | 1
```

The query for this parameter will always return 20 values.

```
[ :SENSe ] :HARMonics:RANGe [ :LIST ] :STATe?
```

Example: HARM:RANG:LIST:STAT ON, OFF, ON, ON

2.12.6.2 Center Freq

Used to set the center frequency of the analyzer.

Key Path: **Meas Setup, Range Table**

Factory Preset: See [Table 2-1 on page 133](#).

Knob Increment: 1%

Step Key

Increment: 1, 1.5, 2, 3, 5, 7.5, 10,...

Range: Frequency range of your analyzer.

History: Added with PSA firmware revision A.03.00

Added with ESA firmware revision A.09.00

Remote Command:

This parameter can send up to 10 values. The location in the list sent corresponds to the range the value is associated. Missing values are not permitted, for example, if you want to change values 2 and 6, you must send all values up to 6. Subsequent values will remain as they were.

```
[ :SENSE ] :HARMonics :RANGe [ :LIST ] :FREQuency <integer>
```

The query for this parameter will always return 10 values.

```
[ :SENSE ] :HARMonics :RANGe [ :LIST ] :FREQuency?
```

Example: HARM:RANG:LIST FREQ 300

2.12.6.3 Span

Span is used to set the span of the analyzer.

Key Path: **Meas Setup, Range Table**

Factory Preset: See [Table 2-1 on page 133](#).

Knob Increment: Steps through the available spans.

Step Key

Increment: Steps through the available spans.

Range: Span of your analyzer.

History: Added with PSA firmware revision A.03.00

Added with ESA firmware revision A.09.00

Remote Command:

This parameter can send up to 10 values. The location in the list sent corresponds to the range the value is associated with. Missing values are not permitted, for example, if you want to change values 2 and 6, you must send all values up to 6. Subsequent values will remain as they were.

```
[ :SENSe] :HARMonics:RANGe [:LIST] :SPAN
[ :SENSe] :HARMonics:RANGe [:LIST] :SPAN?
```

2.12.6.4 Res BW

Sets the resolution bandwidth mode of the analyzer. If the range is zero span and **Res BW** is set to **Auto**, the analyzer determines the optimum setting. **Res BW** set to **Man** enables you to determine the setting.

Key Path: **Meas Setup, Range Table**

Factory Preset: See [Table 2-1](#).

Knob Increment: Steps through the available resolution bandwidth filters.

Step Key

Increment: Steps through the available resolution bandwidth filters.

Range: Resolution bandwidth range of your analyzer.

History: Added with PSA firmware revision A.03.00
 Added with ESA firmware revision A.09.00

Remote Command:

This parameter can send up to 10 values. The location in the list sent corresponds to the range the value is associated with. Missing values are not permitted, for example, if you want to change values 2 and 6, you must send all values up to 6. Subsequent values will remain as they were.

```
[ :SENSe] :HARMonics:RANGe [:LIST] :BWIDth | BANDwidth [:RESolution] :AUTO
OFF | ON | 0 | 1
selects the mode.
```

```
[ :SENSe] :HARMonics:RANGe [:LIST] :BWIDth | BANDwidth [:RESolution] <integer>
```

The query for this parameter always returns 10 values.

```
[ :SENSe] :HARMonics:RANGe [:LIST] :BWIDth | BANDwidth [:RESolution] :AUTO?
[ :SENSe] :HARMonics:RANGe [:LIST] :BWIDth | BANDwidth [:RESolution] ?
```

2.12.6.5 Video BW

Sets the video bandwidth of the analyzer. When **Auto** is selected the analyzer determines the optimum setting, while **Man** enables you to determine the setting.

Key Path: **Meas Setup, Range Table**

Factory Preset: Auto

Knob Increment: Steps through the available video bandwidth filters.

Step Key

Increment: Steps through the available video bandwidth filters.

Range: Video bandwidth range of your analyzer.

History: Added with PSA firmware revision A.03.00

Added with ESA firmware revision A.09.00

Remote Command:

This parameter can send up to 10 values. The location in the list sent corresponds to the range the value is associated with. Missing values are not permitted, for example, if you want to change values 2 and 6, you must send all values up to 6. Subsequent values will remain as they were.

[:SENSE] :HARMonics:RANGe [:LIST] :BWIDth | BANDwidth:VIDeo:AUTO OFF | ON | 0 | 1
selects the mode.

[:SENSE] :HARMonics:RANGe [:LIST] :BWIDth | BANDwidth:VIDeo <integer>

The query for this parameter will always return 10 values.

[:SENSE] :HARMonics:RANGe [:LIST] :BWIDth | BANDwidth:VIDeo:AUTO?

[:SENSE] :HARMonics:RANGe [:LIST] :BWIDth | BANDwidth:VIDeo?

2.12.6.6 Sweep Time

Sets the sweep time of the analyzer. If the range is zero span and **Sweep Time** is set to **Auto**, the sweep time will be 200 divided by the resolution bandwidth or 10 ms, whichever is greater. If the range is non zero span and **Sweep Time** is set to **Auto**, the analyzer determines the optimum setting. **Sweep Time** set to **Man** enables you to determine the setting.

Key Path: **Meas Setup, Range Table**

Factory Preset: Auto

Knob Increment: 1%

Step Key

Increment: 1, 1.5, 2, 3, 5, 7.5, 10,...

Range: Sweep time range of your analyzer.

History: Added with PSA firmware revision A.03.00

Added with ESA firmware revision A.09.00

Remote Command:

This parameter can send up to 10 values. The location in the list sent corresponds to the range the value is associated with. Missing values are not permitted, for example, if you want to change values 2 and 6, you must send all values up to 6. Subsequent values will remain as they were.

```
[ :SENSe] :HARMonics:RANGe [:LIST] :SWEep:TIME:AUTO OFF | ON | 0 | 1 selects the mode.
```

```
[ :SENSe] :HARMonics:RANGe [:LIST] :SWEep:TIME: <integer>
```

The query for this parameter will always return 10 values.

```
[ :SENSe] :HARMonics:RANGe [:LIST] :SWEep:TIME:AUTO?
```

```
[ :SENSe] :HARMonics:RANGe [:LIST] :SWEep:TIME?
```

2.12.6.7 Auto Fill Range Table

Auto Fill Range Table is used to automatically setup the range table based on the current range center frequency and span. When selected, the current center frequency is taken as the fundamental and the frequency in range one is set to this value. Each of the subsequent range center frequency parameters are set to the appropriate integer multiple of the fundamental frequency. The span for range one is set to that of the current range. Each of the subsequent range span parameters are set to the appropriate integer multiple of the fundamental span. This means that if the fundamental range is zero span, all the ranges will be zero span. If the range span is zero, **Res BW**, **Video BW**, and **Sweep Time** are set to the current base instrument settings. If the range span is non-zero, **Res BW**, **Video BW**, and **Sweep Time** for all harmonics are set to the same settings as for the fundamental. Span is set to zero for all harmonics and the fundamental.

Key Path: **Meas Setup, Range Table**

Knob Increment: 1%

Step Key

Increment: 1, 1.5, 2, 3, 5, 7.5, 10,...

Range: Sweep time range of your analyzer.

History: Added with PSA firmware revision A.03.00

Added with ESA firmware revision A.09.00

Remote Command:

```
[ :SENSe] :HARMonics:RTABle:FILL <no query>
```

Example: HARM:RTAB:FILL

2.12.7 Optimize Ref Level

Sets the input attenuator and reference level to optimize the robustness of the measurement, which is its freedom from errors due to input compression and log amp range limitations.

NOTE There will always be a minimum attenuation of 2 dB for PSA or 5 dB for ESA set to reduce the potential VSWR errors.

Key Path: **Meas Setup**

State Saved: Saved in instrument state.

History: Added with PSA firmware revision A.02.00.

Remote Command:

```
[ :SENSE ] :POWer [ :RF ] :RANGe:AUTO ONCE
```

Example: POW:RANG:AUTO ONCE

2.13 Trace/View (Channel Power Measurement)

If **Channel Power** has been selected in the Measure menu of the Spectrum Analysis mode, this key displays the appropriate **Trace/View** menu for the channel power measurement.

Displays menu keys that enable you to set how trace information is stored and displayed.

Key Path: Front-panel key

Factory Preset: Spectrum

History: Added with PSA firmware revision A.02.00

Remote Command:

There is no equivalent remote command for this function.

2.13.1 Spectrum

Pressing **Spectrum** selects the spectral display of the measurement.

Key Path: **Trace/View**

Factory Preset: Spectrum

History: Added with PSA firmware revision A.02.00

Remote Command:

There is no remote command for this function.

2.13.2 Combined

Pressing **Combined** selects the measurement to be displayed as a bar graph and spectrum.

Key Path: **Trace/View**

Factory Preset: Spectrum

History: Added with PSA firmware revision A.02.00

Remote Command:

There is no remote command for this function.

2.13.3 Trace

One-button measurements do not change this function. See Volume 1, *Core Spectrum Analyzer Functions User's and Programmer's Reference* guide for information about **Trace** and its lower-level functions.

One-Button Measurement Functions
Trace/View (Channel Power Measurement)

2.14 Trace/View (Harmonic Distortion)

If **Harmonic Distortion** has been selected in the Measure menu of the Spectrum Analysis mode, this key displays the appropriate **Trace/View** menu to view the harmonic measurement results.

Displays menu keys to view the harmonic measurement results in two views, **Harmonic** and **Harmonic & THD**.

Key Path: Front-panel key

History: Modified with PSA firmware revision A.03.00

Added with PSA firmware revision A.02.00

Added with ESA firmware revision A.08.00

2.14.1 Harmonics

Press **Harmonics** to view the measurement results in numeric form.

Key Path: **Trace/View**

2.14.2 Harmonics & THD

Press **Harmonics & THD** to view the measurement results in numeric form, as well as the total harmonic distortion (THD) displayed as a percentage and as a dB value.

Key Path: **Trace/View**

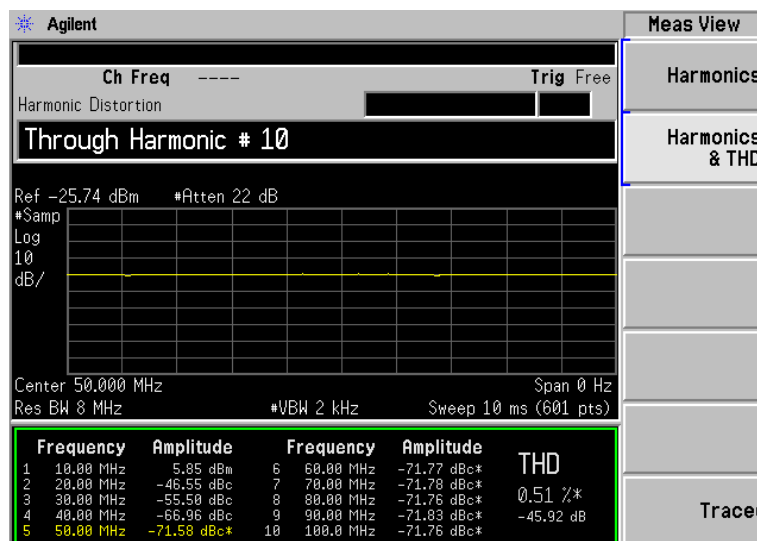

One-Button Measurement Functions
Trace/View (Harmonic Distortion)

2.15 Meas Setup (Intermod (TOI))

When **Intermod (TOI)** measurement has been selected in the Measure menu of the Spectrum Analysis Mode, this key displays the appropriate measurement setup menu for third order intercept (TOI).

The TOI measurement computes and displays the output intercept point (IP3), and places markers upon the trace to indicate the measured signals and third-order products. The span must be wide enough so that the signals and their intermod products are visible on the display. Otherwise the TOI signal pattern cannot be identified and the measurement routine will not function.

Key Path: Front-panel key

Dependencies/

Couplings: Menu changes depending on the Mode and Measurement selected.

History: Added with PSA firmware revision A.02.00

Added with ESA firmware revision A.08.00

Remote Command:

There is no equivalent remote command.

2.15.1 Avg Number

Set **Avg Number** to On to specify the number of measurement averages used when calculating the measurement result. The average will be displayed at the end of each sweep. Setting **Avg Number** to Off disables measurement averaging.

Key Path: **Meas setup**

State Saved: Saved in instrument state.

Factory Preset: 10 averages / Off

Range: 1 through 1000

History: Added with PSA firmware revision A.02.00

Added with ESA firmware revision A.08.00

Remote Command:

```
[ :SENSe] :TOIN:AVERAge:COUNT <integer>
```

```
[ :SENSe] :TOIN:AVERAge:COUNT?
```

```
[ :SENSe] :TOIN:AVERAge[:STATe] OFF|ON|0|1
```

```
[ :SENSe] :TOIN:AVERAge[:STATe]?
```

Example: TOIN:AVER ON

TOIN:AVER?

2.15.2 Avg Mode

Press **Avg Mode** to select the type of termination control used for the averaging function to either **Exp** or **Repeat**. This determines the averaging action after the specified number of measurements (average count) is reached.

- **EXP** (Exponential Averaging mode)—When you set **Avg Mode** to **Exp**, each successive data acquisition after the average count is reached is exponentially weighted and combined with the existing average. Exponential averaging weights new data more than old data, which facilitates tracking of slow-changing signals. The average will be displayed at the end of each sweep.
- **Repeat**—When you set **Avg Mode** to **Repeat**, after reaching the average count, all previous result data is cleared and the average count is set back to 1.

Key Path: **Meas Setup**

State Saved: Saved in instrument state.

Factory Preset: EXponential

History: Added with PSA firmware revision A.02.00
 Added with ESA firmware revision A.08.00

Remote Command:

```
[ :SENSE ] :TOIN:AVERage:TCONrol EXPonential | REPeat  
[ :SENSe ] :TOIN:AVERage:TCONrol?  
Example:            TOIN:AVG:TCON EXP  
                      TOIN:AVG:TCON?
```

2.15.3 TOI Span

Press **Span** to specify the frequency span in which intermodulation products are measured.

Key Path: **Meas Setup**

Key Note: If you modify the value of Span in the base instrument Span menu, the value in the Meas Setup menu will be updated to reflect the new value and the measurement will restart if it is running.

Factory Preset: 15 MHz, or as defined by the radio standard selected.

Range: Non-Zero Span of Analyzer

History: Added with PSA firmware revision A.02.00
 Added with ESA firmware revision A.08.00

Remote Command:

[:SENSe] :TOIN:FREQuency:SPAN <number>

[:SENSe] :TOIN:FREQuency:SPAN?

Example: TOIN:FREQ:SPAN 20 MHz
 TOIN:FREQ:SPAN?

2.15.4 Max Mixer Lvl

Enables you to set the relationship between the highest signal that can be displayed (the reference level) and the input attenuation. The relationship applies whenever the **Attenuation** is set to **Auto**. The relationship is that the attenuation is given by reference level minus the max mixer level. For example, as the reference level changes, the input attenuator changes to ensure that a signal at the reference level does not exceed the **Max Mixer Lvl** setting.

When the TOI measurement is on, this key controls the maximum mixer level, independent of the previous setting of **Max Mixer Lvl** located under **Amplitude**. When the TOI measurement is **Off**, the previous maximum **Max Mixer Lvl** is restored.

Setting **Max Mixer Lvl** to **Auto** sets the maximum mixer level to -30 dBm.

Key Path: **Meas Setup**

Factory Preset: -30.00 dBm/Auto

Range: 0 VDC, +30 dBm

History: Added with PSA firmware revision A.02.00
 Added with ESA firmware revision A.08.00

Remote Command:

[:SENSe] :TOIN:FREQuency:MIXer:RANGe [:UPPer] <number>

[:SENSe] :TOIN:FREQuency:MIXer:RANGe [:UPPer] ?

[:SENSe] :TOIN:FREQuency:MIXer:RANGe:AUTO OFF | ON | 0 | 1

[:SENSe] :TOIN:FREQuency:MIXer:RANGe:AUTO?

Example: TOIN:FREQ:MIX:RANG -10 dBm
 TOIN:FREQ:MIX:RANG?
 TOIN:FREQ:MIX:RANG:AUTO 1
 TOIN:FREQ:MIX:RANG:AUTO?

2.15.5 Optimize Ref Level

Sets the reference level to place the tones near the top of the display. When input attenuation is set to **Auto**, pressing **Optimize Ref Level** sets the input attenuation according to the auto rules described in [Max Mixer Lvl](#), based on this reference level. You may want to trade off analyzer noise and analyzer-induced distortion by manually changing the attenuation setting from this starting point.

NOTE There is always a minimum of 2 dB for PSA or 5 dB for ESA of attenuation set to protect the analyzer input.

Key Path: **Meas Setup**

State Saved: Saved in instrument state.

History: Added with PSA firmware revision A.02.00
Added with ESA firmware revision A.08.00

Remote Command:

```
[ :SENSe ] :POWer [ :RF ] :RANGe :AUTO ONCE
```

Example: TOIN:RANG:AUTO ONCE
TOIN:RANG:AUTO?

2.16 Meas Setup (Multi-Carrier Power—MCP)

If the MCP measurement has been selected in the Measure menu of the Spectrum Analysis mode, this key displays the MCP measurement setup menu.

The Multi-Carrier Power measurement is a measure of the power in two or more transmit channels and of the power that leaks into their adjacent transmit channels. The results reported are similar to the adjacent channel power measurement, but the setup is different to allow for two or more carriers to be present.

Key Path: Front-panel key

Dependencies/

- Couplings:
- Parameter defaults change depending on the Radio Standard selected.
 - Sweep time is coupled to span, RBW, and VBW if the measurement method is set to IBW.
 - ESA Only: Video BW \geq 10 times RBW (if possible)

History: Added with PSA firmware revision A.02.00

Added with ESA firmware revision A.08.00

Remote Command:

There is no equivalent remote command.

2.16.1 Avg Number

Pressing **Avg Number** to **On** enables you to specify the number of measurements that will be averaged when calculating the measurement result. The average will be displayed at the end of each sweep. Setting **Avg Number** to **Off** disables the measurement averaging.

Key Path: **Meas Setup**

State Saved: Saved in instrument state.

Factory Preset: 10 / Off

Range: 1 through 1000

History: Added with PSA firmware revision A.02.00

Added with ESA firmware revision A.08.00

Remote Commands:

```
[ :SENSe ] :MCPower :AVERAge :COUNT <integer>  
[ :SENSe ] :MCPower :AVERAge :COUNT?  
[ :SENSe ] :MCPower :AVERAge [ :STATe ] OFF | ON | 0 | 1  
[ :SENSe ] :MCPower :AVERAge [ :STATe ] ?
```

Example: MCP: AVER: COUN 10
 MCP: AVER: COUN?
 MCP: AVER OFF
 MCP: AVER?

2.16.2 Avg Mode

Press **Avg Mode** to select the type of termination control used for the averaging function as either **Exp** or **Repeat**. This determines the averaging action after the specified number of measurements (average count) is reached.

- **EXP** (Exponential Averaging mode)—When you set **Avg Mode** to **Exp**, each successive data acquisition after the average count is reached is exponentially weighted and combined with the existing average. Exponential averaging weights new data more than old data, which facilitates tracking of slow-changing signals. The average will be displayed at the end of each sweep.
- **Repeat**—When you set **Avg Mode** to **Repeat**, after reaching the average count, all previous result data is cleared and the average count is set back to 1.

Key Path: **Meas Setup**
State Saved: Saved in instrument state.
Factory Preset: Exponential
History: Added with PSA firmware revision A.02.00
 Added with ESA firmware revision A.08.00

Remote Command:

```
[ :SENSe ] :MCPower :AVERAge :TCONrol EXPonential | REPEAT  
[ :SENSe ] :MCPower :AVERAge :TCONrol?  
Example:        MCP: AVG: TCON EXP  
                  MCP: AVG: TCON?
```

2.16.3 Carrier Setup

Accesses the Carrier Setup and Configure Carriers menus that allow you to define the various parameters for each carrier.

Key Path: **Meas Setup**
History: Added with ESA firmware revision A.09.00.
 Added with PSA firmware revision A.03.00.

Remote Command:

There is no equivalent remote command.

2.16.3.1 Carriers

Press **Carriers** to specify the number of carriers to be measured.

Key Path: **Meas Setup, Carrier Setup**
Factory Preset: 4
Step Key
Increment: 1
Range: 2 to 12
History: Added with ESA firmware revision A.09.00.
 Added with PSA firmware revision A.03.00.

Remote Command:

```
[ :SENSe ] :MCPower:CARRier:COUNT<integer>  
[ :SENSe ] :MCPower:CARRier:COUNT?  
Example:           MCP:CARR:COUN 10  
                      MCP:CARR:COUN?
```

2.16.3.2 Ref Carrier

Press **Ref Carrier** (Man) to specify the carrier (identified by a numeric position) from which all relative power measurements will be made. When **Ref Carrier** is set to **Auto**, the analyzer selects the carrier with the highest power as the reference.

Key Path: **Meas Setup, Carrier Setup**

One-Button Measurement Functions

Meas Setup (Multi-Carrier Power—MCP)

Key Notes: The carrier must have power present in order to be assigned as a reference carrier frequency. If you change the reference carrier's power present value from "yes" to "no", the next carrier to the left (or to the right, if there are none to the left) will be assigned as the reference carrier. If it currently has power present set to No, this will change to Yes. This is also true when there are only two carriers with a "yes" value. Refer to the "[Carrier Pwr Present](#)" key description for more information on setting the carrier power present value.

Factory Preset: Auto

Range: Auto/Man
1 to 12

History: Added with ESA firmware revision A.09.00.
Added with PSA firmware revision A.03.00.

Remote Command:

```
[ :SENSE ] :MCPower:RCARrier:AUTO OFF | ON | 0 | 1
```

```
[ :SENSe ] :MCPower:RCARrier:AUTO?
```

```
[ :SENSe ] :MCPower:RCARrier<integer>
```

```
[ :SENSe ] :MCPower:RCARrier?
```

Remote Command Notes: Refer to "[Key Notes:](#)" above.

Example: MCP:RCAR:AUTO ON

```
MCP:RCAR 3
```

```
MCP:RCAR?
```

2.16.3.3 Ref Carrier Freq

The **Ref Carrier Freq** setting determines whether the Ref Carrier Freq is calculated based on the Center frequency (Auto) or the Center frequency is calculated based on the Ref Carrier Freq (Man). The Ref Carrier Freq value will always be updated if the Ref Carrier Freq setting is changed, whether the Mode is set to Auto or Man.

If **Ref Carrier Freq** is set to auto, it is assumed that the carriers are distributed evenly around the current center frequency. In this case the following three steps are used to calculate the Ref Carrier Freq value and the calculated Ref Carrier Freq is shown on the **Ref Carrier Freq** key:

1. Ref Freq 1 = Cntr Freq – [(Total of all Carrier Widths)/2]
2. Ref Freq 2 = Ref Freq 1 + (Total of all Carrier Widths excluding the Ref Carrier Width)
3. Ref Freq = Ref Freq 2 + [0.5 (Carrier Width of Ref Carrier)]

The **Ref Carrier Freq** can also be entered by the user. This will set the Ref Carrier Freq to Man and the Center frequency of the analyzer will be calculated using the following three steps:

1. Cntr Freq 1 = Ref Freq – [0.5 (Carrier Width of Ref Carrier)]
2. Cntr Freq 2 = Cntr Freq 1 – (Total of all Carrier Widths excluding the Ref Carrier Width)
3. Cntr Freq = Cntr Freq 2 + [(Total of all Carrier Widths)/2]

The above algorithms ensure that the carrier is centered on the analyzer display.

Key Path: **Meas Setup, Carrier Setup**

Dependencies/

Couplings: The reference carrier can be re-assigned by implementing changes to carrier power present values.

State Saved: Saved in instrument state.

Factory Preset: Auto/Calculated based on current center frequency. Refer to the algorithm above when defining the **Ref Carrier Freq**(Auto) key.

Terminators: Hz, kHz, MHz, GHz

Default Terminator GHz

Resolution: 1 Hz

Knob Increment: Span ÷ 50

Step Key

Increment: If **CF Step**(Auto) is selected: span/10.
 If **CF Step**(Man) is selected: CF Step

Range: Analyzer minimum to analyzer maximum

History Added with ESA firmware revision A.09.00.

 Added with PSA firmware revision A.03.00.

Remote Command:

[:SENSe] :MCPower:RCFrequency<Freq>

[:SENSe] :MCPower:RCFrequency?

[:SENSe] :MCPower:RCFrequency:AUTO OFF | ON | 0 | 1

[:SENSe] :MCPower:RCFrequency:AUTO?

Example: MCP:RCFR 2 GHz

 MCP:RCFR?

2.16.3.4 Configure Carriers

Accesses the Config Carriers menu that allows further definition of each carrier.

Key Path: **Meas Setup, Carrier Setup**

History: Added with ESA firmware revision A.09.00.
Added with PSA firmware revision A.03.00.

Remote Command:

There is no equivalent remote command.

2.16.3.4.1 Carrier

Selects the carrier number you wish to configure.

Key Path: **Meas Setup, Carrier Setup, Configure Carriers**

Dependencies/

Couplings: All keys available on the Configure Carrier menu are coupled to this key.

State Saved: Saved in instrument state.

Factory Preset: 1

Knob Increment: 1

Step Key

Increment: 1

Range: 2 to 12

History: Added with ESA firmware revision A.09.00.
Added with PSA firmware revision A.03.00.

Remote Command:

There is no equivalent remote command.

2.16.3.4.2 Carrier Pwr Present

Press **Carrier Pwr Present** (Yes) to specify carriers which have power present. First, press the **Carrier** key and select the carrier number you wish to define, using the Step Keys (\downarrow \uparrow), the knob, or the numeric keypad. (The carrier number selected is shown on the **Carrier** key.) Then toggle the **Carrier Pwr Present** key to indicate either yes or no.

If a carrier is defined as having no power present, the power displayed will be relative to the reference carrier. If a carrier is defined as having power present, the absolute power will be displayed.

Carriers with power present are included in the total carrier power result.

Key Path: **Meas Setup, Carrier Setup, Configure Carriers**

Dependencies/
 Couplings: This key assigns a value (yes or no) to the carrier number displayed on the **Carrier** key.

State Saved: Saved in instrument state.

Factory Preset: YES, YES, YES, YES

Range: Yes or No

History: Added with ESA firmware revision A.09.00.
 Added with PSA firmware revision A.03.00.

Remote Command:

```
[ :SENSe] :MCPower:CARRier:LIST:PPResent YES|NO
[ :SENSe] :MCPower:CARRier:LIST:PPResent?
```

Remote Command Notes:

- The position number in the list sent corresponds to the carrier number you are designating. For example: “YES, YES, NO, YES, YES, NO” defines six carriers. Carriers 1, 2, 4, and 5 are defined as having power present whereas carriers 3 and 6 do not have power present. If you need to change carrier 5, you must send all carriers up to 5. Carrier 6 will remain unchanged. If you send more values than the number of carriers specified using the **Carriers** key, (in this example, there are six carriers) they will be ignored.
- The query for this parameter returns the current value for all carriers (with and without power present).

Example: MCP:CARR:PPR YES,NO,YES,NO,YES
 MCP:CARR:PPR?

2.16.3.4.3 Carrier Width

Press **Carrier Width** to specify the width of each carrier including carriers with no power present. There is a corresponding one-to-one relationship between each carrier width value and the specified number of carriers. First, press the **Carrier** key and select the carrier number you wish to define, using the Step Keys (↓ ↑), the knob, or the numeric keypad. (The carrier number selected is shown on the **Carrier** key.) Then press the **Carrier Width** key and enter the width using the numeric keypad.

Key Path: **Meas Setup, Carrier Setup, Configure Carriers**

Key Notes: The **Carrier** key determines which carrier width you are defining.

State Saved: Saved in instrument state.

Factory Preset: 5 MHz, 5 MHz, 5 MHz, 5 MHz

Terminators: Hz, kHz, MHz, GHz

Default Terminator: Hz

One-Button Measurement Functions

Meas Setup (Multi-Carrier Power—MCP)

Resolution: 1 Hz

Step Key
Increment: If **CF Step**(Auto) is selected: span/10.
If **CF Step**(Man) is selected: CF Step

Range: 0 Hz to 500 MHz

History: Added with ESA firmware revision A.09.00.
Added with PSA firmware revision A.03.00.

Remote Command:

```
[ :SENSe ] :MCPower :CARRier :LIST :WIDTh <Hz>
```

```
[ :SENSe ] :MCPower :CARRier :LIST :WIDTh?
```

Remote Command Notes:

- The position number of the each carrier width in the list sent corresponds to the carrier number you are defining. For example: “5 MHz, 10 MHz, 5 MHz” defines six carriers. Carriers 1, 2, 4, and 5 are defined as having power present whereas carriers 3 and 6 do not have power present. If you need to change carrier 5, you must send all carriers up to 5. Carrier 6 will remain unchanged. If you send more values than the number of carriers specified using the **Carriers** key, (in this example, there are six carriers) they will be ignored.
- The query for this parameter returns the current value for all carriers (with and without power present).

Example: MCP:CARR:LIST:WIDT 5 MHz,10 MHz,4 MHz,15 MHz,5 MHz,10 MHz
MCP:CARR:LIST:WIDT?

2.16.3.4.4 Carrier IntegBW

Press **Carrier IntegBW** to define the integration bandwidth used to calculate the power in the carriers.

Key Path: **Meas Setup, Carrier Setup, Configure Carriers**

State Saved: Saved in instrument state.

SCPI Status Bits/

OPC Dependencies: The integration bandwidth is specified differently depending on the radio standard selected. If **Mode Setup, Radio Std, 3GPP W-CDMA** is selected and the RRC filter is on, the actual integration bandwidth used will be the displayed integration bandwidth multiplied by (1 + filter alpha).

Factory Preset: 3.84 MHz, 3.84 MHz, 3.84 MHz, 3.84 MHz

Terminators: Hz, kHz, MHz, GHz

Default Terminator Hz

Resolution:

Knob Increment: Span ÷ 50

Step Key
Increment: If **CF Step**(Auto) is selected: span/10.
If **CF Step**(Man) is selected: CF Step
Range: 100 Hz to 500 MHz
History: Added with ESA firmware revision A.09.00.
Added with PSA firmware revision A.03.00.

Remote Command:

```
[ :SENSe] :MCPower:CARRier:LIST:BANDwidth|BWIDth[:INTegration]<Hz>  
[:SENSe]:MCPower:CARRier:LIST:BANDwidth|BWIDth[:INTegration]?  
Example: MCP:CARR:LIST:BAND 3.5MHz,2.85MHz,3.84MHz
```

2.16.4 Offsets/Limits

Displays menu keys that enable you to configure the offsets and limits for the MCP measurement.

Key Path: **Meas Setup**
History: Added with ESA firmware revision A.02.00
Added with PSA firmware revision A.08.00

Remote Command:

There is no equivalent remote command.

2.16.4.1 Offset

Enables you to select the offset the menu keys will affect. Press **Offset** until the letter of the desired offset (A, B, or C) is underlined.

Key Path: **Meas Setup, Offset/Limits**
Factory Preset: A
History: Added with PSA firmware revision A.02.00
Added with ESA firmware revision A.08.00

Remote Command:

There is no equivalent remote command.

2.16.4.2 Offset Freq

Sets the frequency difference between the center of the uppermost carrier and the center of the upper element of the offset pair, as well as the frequency difference between the center of the lower element of the offset pair and the center of the lowermost carrier. If you set the frequency of any offset to 0 Hz, the offset is turned off and not included in the displayed results.

Key Path: **Meas Setup, Offset/Limits**
State Saved: Saved in instrument state.
Factory Preset: 5 MHz, 10 MHz, 15 MHz
Terminators: Hz, kHz, MHz, GHz
Default Terminator: Hz
Range: 0 MHz to 45 MHz
History: Added with PSA firmware revision A.02.00
Added with ESA firmware revision A.09.00

Remote Command:

```
[ :SENSe] :MCPower :OFFSet :LIST : [FREQuency] <Hz> , <Hz> , <Hz>  
[ :SENSe] :MCPower :OFFSet :LIST : [FREQuency] ?  
Example: MCP:OFFS:LIST:5MHz,7.5MHz,15MHz  
MCP:OFFS:LIST:?
```

2.16.4.3 Offset Integ BW

Sets the bandwidth over which the power is integrated for the selected offset (refer to “Offset” above).

Key Path: **Meas Setup, Offset/Limits**
Key Notes: If **RRC Filter** is set to **On**, the actual integration bandwidth used is the displayed integration bandwidth multiplied by (1 + **Filter Alpha**).
State Saved: Saved in instrument state.
Factory Preset: 3.84 MHz, 3.84 MHz, 3.84 MHz
Terminators: Hz, kHz, MHz, GHz
Default Terminator: Hz
Knob Increment: Span ÷ 50
Step Key
Increment: If **CF Step**(Auto) is selected: span/10
If **CF Step**(Man) is selected: CF Step
Range: 100 Hz to 20 MHz

History: Added with PSA firmware revision A.03.00
 Added with ESA firmware revision A.09.00

Remote Command:

```
[ :SENSe] :MCPower:OFFSet:LIST:BANDwidth|BWIDth:[ INTegration]<Hz>,<Hz>,<Hz>
[ :SENSe] :MCPower:OFFSet:LIST:BANDwidth|BWIDth:[ INTegration]<Hz>,<Hz>,<Hz>
```

Example: MCP:OFFS:LIST:BWIDth 5MHz,3MHz,5MHz
 MCP:OFFS:LIST:BWID?

2.16.4.4 Upper Offset Limit

Sets the limit for the selected offset (refer to “Offset” above) to the right of the carriers.

Key Path: **Meas Setup, Offset/Limits**

State Saved: Saved in instrument state.

Factory Preset: 0 dB, 0 dB, 0 dB

Default Terminator: dB

Knob Increment: 1

Step Key
 Increment: 5

Range: –200 dB to 200 dB

History: Added with PSA firmware revision A.03.00
 Added with ESA firmware revision A.08.00

Remote Command:

```
:CALCulate:MCPower:OFFSet:LIST:LIMit:POSitive[:UPPer]:DATA <dB>,<dB>,<dB>
:CALCulate:MCPower:OFFSet:LIST:LIMit:POSitive[:UPPer]:DATA?
```

Example: CALC:MCP:OFFS:LIST:LIM:POS:DATA –50dB,–55dB,–60dB
 :CALC:MCP:OFFS:LIST:LIM:POS:DATA?

2.16.4.5 Lower Offset Limit

Sets the limit for the selected offset (refer to “Offset” above) to the left of the carriers.

Key Path: **Meas Setup, Offset/Limits**

State Saved: Saved in instrument state.

Factory Preset: 0 dB, 0 dB, 0 dB

Default Terminator: dB

One-Button Measurement Functions

Meas Setup (Multi-Carrier Power—MCP)

Knob Increment: 1

Step Key

Increment: 5

Range: –200 dB through 200 dB

History: Added with PSA firmware revision A.03.00

Added with ESA firmware revision A.08.00

Remote Command:

```
:CALCulate:MCPower:OFFSet:LIST:LIMit:NEGative[:UPPer]:DATA <dB>, <dB>, <dB>
```

```
:CALCulate:MCPower:OFFSet:LIST:LIMit:NEGative[:UPPer]:DATA?
```

Example: `CALC:MCP:OFFS:LIST:LIM:NEG:DATA -50dB,-55dB,-60dB`

`CALC:MCP:OFFS:LIST:LIM:NEG:DATA?`

2.16.5 Carrier Result

Press **Carrier Result** to select the result you wish to display on the last line of the carrier power results list except when:

- the carrier result number ≤ 4 (the first 4 carrier power results are displayed)
- the carrier result number ≥ 9 (the last 4 carrier power results are displayed)

Key Path: **Meas Setup**

Key Notes: This key is only available when **Meas Control, Measure (Single)** is selected.

State Saved: Not saved.

Factory Preset: 1

Step Key

Increment: 1

Range: 1 to number of carriers.

History: Added with PSA firmware revision A.03.00

Added with ESA firmware revision A.09.00

Remote Command:

There is no equivalent remote command.

2.16.6 Optimize Ref Level

PSA Only: Sets the input attenuator to optimize the robustness of the measurement, which is its freedom from errors due to input compression.

ESA Only: Sets the input attenuator and reference level to optimize the robustness of the measurement, which is its freedom from errors due to input compression and log amp range limitations.

NOTE There will always be a minimum of 2 dB for PSA or 5 dB for ESA of attenuation set to reduce the potential errors due to VSWR.

Key Path: **Meas Setup**
State Saved: Not saved.
History: Added with PSA firmware revision A.02.00
Added with ESA firmware revision A.08.00

Remote Command:

[:SENSe] :POWer [:RF] :RANGe :AUTO ONCE

Example: POW:RANG:AUTO ONCE

2.16.7 Method

Enables you to set the measurement method to either the integration bandwidth method (IBW) or the resolution bandwidth method (RBW). The resolution bandwidth method is most useful for measuring cdmaOne and cdma2000 signals. The integration bandwidth method is preferred for other signals.

Key Path: **Meas Setup**
Key Notes: When Method is set to RBW, neither Noise Correction nor RRC Filter are available.
State Saved: Saved in instrument state.
Factory Preset: IBW
Range: IBW|RBW
History: Added with PSA firmware revision A.02.00.
Added with ESA firmware revision A.09.00.

Remote Command:

[:SENSe] :MCPower :METHod IBW|RBW

[:SENSe] :MCPower :METHod?

Example: MCP:METH RBW
MCP:METH?

2.16.8 Power Ref

Enables you to set the multi-carrier power reference to automatic or manual. When set to automatic, the carrier power result reflects the measured power value in the selected reference carrier (**Meas Setup, Carrier Setup, Ref Carrier**). When set to manual, the result is referenced to the last measured value, or you may specify the reference for the multi-carrier power measurement. Relative values are displayed, referenced to the “Power Reference” value.

Key Path: **Meas Setup**

State Saved: Saved in instrument state.

Factory Preset: Off/Measured power in the reference carrier.

Terminators: dBm

Default Terminator: dBm

Range: –200 dBm to 200 dBm

History: Added with PSA firmware revision A.02.00.
Added with ESA firmware revision A.09.00.

Remote Command:

```
[ :SENSE ] :MCPower :CARRier :AUTO [ :STATe ] OFF | ON | 0 | 1  
[ :SENSE ] :MCPower :CARRier :AUTO [ :STATe ] ?  
[ :SENSE ] :MCPower :CARRier [ :POWer ] <dBm>  
[ :SENSE ] :MCPower :CARRier [ :POWer ] ?
```

Example: MCP:CARR:AUTO 0
MCP:CARR:AUTO?
MCP:CARR -100
MCP:CARR?

2.16.9 Limit Test

Pressing **Limit Test** turns the testing of the limit line on or off. When **Limit Test** is set to **On**, each offset is compared to its upper and lower offset limit. In those cases where the power exceeds the limit, a red “F” is placed next to the dBc result to indicate a failure. If there are any failures, the pass/fail indicator area show “FAIL” in red; if there are none, it shows “PASS” in green. Any offsets that are in the off state (see “Offset Freq” on page 156) are not measured and their results will not be displayed on screen.

Key Path: **Meas Setup, More**

State Saved: Saved in instrument state.

Factory Preset: Off

History: Added with PSA firmware revision A.02.00
 Added with ESA firmware revision A.08.00

Remote Command:

[:SENSe] :MCPower:LIMit [:STATe] OFF | ON | 0 | 1

[:SENSe] :MCPower:LIMit [:STATe] ?

Example: MCP:LIM ON
 MCP:LIM?

2.16.10 RRC Filter

Pressing **RRC Filter** turns the Root Raised Cosine filter on or off for the carriers and all adjacent channels. The RRC filter is the type specified in the 3GPP W-CDMA standards, with rolloff (α) = **Filter Alpha** parameter (defined below). T is set to 1/Carrier Integ BW (for carriers) or 1/Offset Integ BW (for Offsets).

Key Path: **Meas Setup, More**

Key Notes: This key is not available when **Meas Setup, Method** (RBW) is selected.

State Saved: Saved in instrument state.

Factory Preset: Off

History: Added with PSA firmware revision A.02.00
 Added with ESA firmware revision A.09.00

Remote Command:

[:SENSe] :MCPower:FILTer [:RRC] [:STATe] OFF | ON | 0 | 1

[:SENSe]:MCPower:FILTer[:RRC][:STATe]?

Example: MCP:FILT 1
 MCP:FILT?

2.16.11 Filter Alpha

Press **Filter Alpha** to input the alpha value for the RRC Filter. This parameter is only available when **3GPP W-CDMA** has been selected as the radio standard from the Mode Setup menu.

Key Path: **Meas Setup, More**

State Saved: Saved in instrument state.

Factory Preset: 0.22 when W-CDMA is selected, otherwise Off.

Range: 0.01–1.00

One-Button Measurement Functions

Meas Setup (Multi-Carrier Power—MCP)

History: Added with PSA firmware revision A.03.00.
Added with ESA firmware revision A.09.00.

Remote Command:

```
[ :SENSe] :MCPower :FILTer [ :RRC] :ALPHA <number>
```

```
[ :SENSe] :MCPower :FILTer [ :RRC] :ALPHA?
```

Example: MCP:FILT:ALPHA .33
MCP:FILT:ALPHA?

2.16.12 Noise Correction

Pressing **Noise Correction** turns noise correction on or off. When you set **Noise Correction** to **On**, a calibration of the noise floor is performed and used to correct for analyzer noise floor contribution to measurement levels, increasing dynamic range.

Key Path: **Meas Setup, More**

Key Notes: This key is not available when **Meas Setup, Method** (RBW) is selected or when signal tracking is on.

State Saved: Saved in instrument state.

Factory Preset: Off

History: Added with PSA firmware revision A.02.00.
Added with ESA firmware revision A.09.00.

Remote Command:

```
[ :SENSe] :MCPower :CORRection :NOISe [ :AUTO] OFF | ON | 0 | 1
```

```
[ :SENSe] :MCPower :CORRection :NOISe [ :AUTO] ?
```

Remote Command Notes: The noise correction feature is not available when the measurement method is RBW (**Meas Setup, Method** (RBW) or when signal tracking is on.

Example: MCP:CORR:NOIS 1
MCP:CORR:NOIS?

2.17 Trace/View (Multi-Carrier Power Measurement)

If **Multi-Carrier Power** has been selected in the Measure menu of the Spectrum Analysis mode, this key displays the appropriate **Trace/View** menu for the multi-carrier power measurement.

Displays menu keys that enable you to set how trace information is stored and displayed.

Key Path: Front-panel key

History: Added with PSA firmware revision A.02.00
Added with ESA firmware revision A.08.00

Remote Command:

There is no equivalent remote command for this function.

2.17.1 Spectrum

Pressing **Spectrum** selects the spectral display of the measurement.

Key Path: **Trace/View**

Factory Preset: Spectrum

History: Added with PSA firmware revision A.02.00
Added with ESA firmware revision A.08.00

Remote Command:

There is no remote command for this function.

2.17.2 Combined

Pressing **Combined** selects the measurement to be displayed as a bar graph and spectrum.

Key Path: **Trace/View**

Factory Preset: Spectrum

History: Added with PSA firmware revision A.02.00
Added with ESA firmware revision A.08.00

Remote Command:

There is no remote command for this function.

2.17.3 Combined View Units

Pressing **Combined View Units** selects the units (**dBc** or **dBm**) for the floating numeric displays when **Combined** is selected.

Key Path: **Trace/View**

Factory Preset: dBc

History: Added with PSA firmware revision A.02.00
Added with ESA firmware revision A.08.00

Remote Command:

There is no remote command for this function.

2.17.4 Trace

One-button measurements do not change this function. See Volume 1, *Core Spectrum Analyzer Functions User's and Programmer's Reference* guide for information about **Trace** and its lower-level functions.

2.18 Meas Setup (Occupied Bandwidth—OBW)

When **Occupied BW** has been selected in the Measure menu of the Spectrum Analysis Mode, this key displays the appropriate measurement setup menu.

The Occupied Bandwidth measurement integrates the power of the displayed spectrum and puts markers at the frequencies between which a selected percentage of the power is contained. The measurement defaults to 99% of the occupied bandwidth power. The power-bandwidth routine first computes the combined power of all signal responses contained in the trace. For 99% occupied power bandwidth, markers are placed at the frequencies on either side of 99% of the power and 1% of the power is evenly distributed outside the markers. The difference between the marker frequencies is the 99% power bandwidth and is the value displayed.

The occupied bandwidth function also indicates the difference between the analyzer center frequency and the center frequency of the channel, referred to as “Transmit Freq Error.” The measurement can be made in single or continuous sweep mode. The center frequency, reference level, and channel spacing must be set by the user.

Key Path: Front-panel key

2.18.1 Avg Number

Press **Avg Number** (On) to specify the number of measurement averages used when calculating the measurement result. The average is displayed at the end of each sweep. Press **Avg Number** (Off) to disable measurement averaging.

Key Path: **Meas Setup**

State Saved: Saved in instrument state.

Factory Preset: 10 averages / Off

Range: 1 through 1000

Remote Command:

```
[ :SENSe]:OBWidth:AVERage:COUNT <integer>
```

```
[ :SENSe]:OBWidth:AVERage:COUNT?
```

```
[ :SENSe]:OBWidth:AVERage[:STATe] OFF|ON|0|1
```

```
[ :SENSe]:OBWidth:AVERage[:STATe]?
```

Example: OBW:AVER:COUN 20

```
OBW:AVER:COUN?
```

```
OBW:AVER ON
```

```
OBW:AVER?
```

2.18.2 Avg Mode

Enables you to select the type of termination control used for the averaging function (**Exp** or **Repeat**). This determines the averaging action after the specified number of measurements (average count) is reached.

ESA Only: **Avg Mode** has no effect on measurements that are not averaged.

- **EXP** (Exponential Averaging mode)—Each successive data acquisition after the average count is reached is exponentially weighted and combined with the existing average. Exponential averaging weights new data more than old data, which facilitates tracking of slow-changing signals. The average is displayed at the end of each sweep.
- **Repeat**—After reaching the average count, all previous result data is cleared and the average count is set back to 1.

Key Path: **Meas Setup**

State Saved: Saved in instrument state.

Factory Preset: EXPOnential

Remote Command:

```
[ :SENSe ] :OBW:AVERAge:TCONtrol EXPOnential | REPeat
```

```
[ :SENSe ] :OBW:AVERAge:TCONtrol ?
```

Example: OBW:AVG:TCON EXP

OBW:AVG:TCON?

2.18.3 Max Hold

Enables you to turn maximum hold trace feature on or off for the measurement. Maximum hold displays and holds the maximum responses of a signal.

Key Path: **Meas Setup**

State Saved: Saved in instrument state.

Factory Preset: Off

Remote Command:

```
[ :SENSe ] :OBW:MAXHold OFF | ON | 0 | 1
```

```
[ :SENSe ] :OBW:MAXHold ?
```

Example: OBW:MAXH ON

OBW:MAXH?

2.18.4 Occ BW % Pwr

Enables you to change the percentage of signal power used when determining the occupied bandwidth.

Key Path: **Meas Setup**
State Saved: Saved in instrument state.
Factory Preset: 99.0%
Range: 10.0% through 99.99%

Remote Command:

```
[ :SENSe ] :OBwidth:PERCent <percent>  
[ :SENSe ] :OBwidth:PERCent?  
Example:            OBW:PERC 98  
                    OBW:PERC?
```

2.18.5 OBW Span

Enables you to specify the range of integration used in calculating the total power from which the percent occupied bandwidth is then calculated. The analyzer span will be set to the same value as the OBW Span for the measurement. OBW Span should be set to approximately 2 times the expected occupied bandwidth result.

NOTE If you have an adjacent channel, you should not set the OBW span to 2 times your occupied bandwidth. The OBW measurement first computes all the power in the span and then 99% of that. Diamond markers are set around the bandwidth, and the occupied bandwidth results is displayed in the data window. If the power of the adjacent channel is included in the calculation for the 100% power, the OBW result will be too high. The OBW Span should be set narrow enough to encompass the channel of interest and exclude any unwanted adjacent channels.

Key Path: **Meas Setup**
Factory Preset: 3 MHz, or as defined by the radio standard selected.
Default Terminator: Hz
Range: 100 Hz to maximum span of the analyzer.

Remote Command:

```
[ :SENSe ] :OBW:FREQuency:SPAN <freq>  
[ :SENSe ] :OBW:FREQuency:SPAN?  
Example:            OBW:FREQ:SPAN 10 MHz  
                    OBW:FREQ:SPAN?
```

2.18.6 x dB

Enables you to specify the power level used to determine the emission bandwidth as the number of dB down from the highest signal point (P_1), within the occupied bandwidth span. This function is an independent calculation from the OBW calculation. The x dB Bandwidth result is also called the emissions bandwidth, or EBW. This will set arrow markers (f_1 and f_2) to your specified dB value below the maximum power and compute the total power between those arrows. Frequencies f_1 and f_2 are determined as the furthest frequencies x dB below and above P_1 , respectively. The emission bandwidth is then calculated as $f_2 - f_1$ as shown by the arrows indicated in Figure 2-1 (note that the diamond markers are for the OBW function).

NOTE The asterisk next to the x dB bandwidth value in Figure 2-1 indicates the results may not have been determined with optimal analyzer settings. If emission bandwidth is your primary interest, select **Meas Setup, Max Hold**. Then change detector mode to peak by pressing **Det/Demod, Detector, Peak**. Acquiring peak data ensures accuracy of this measurement.

Figure 2-1 Occupied Bandwidth Measurement Results

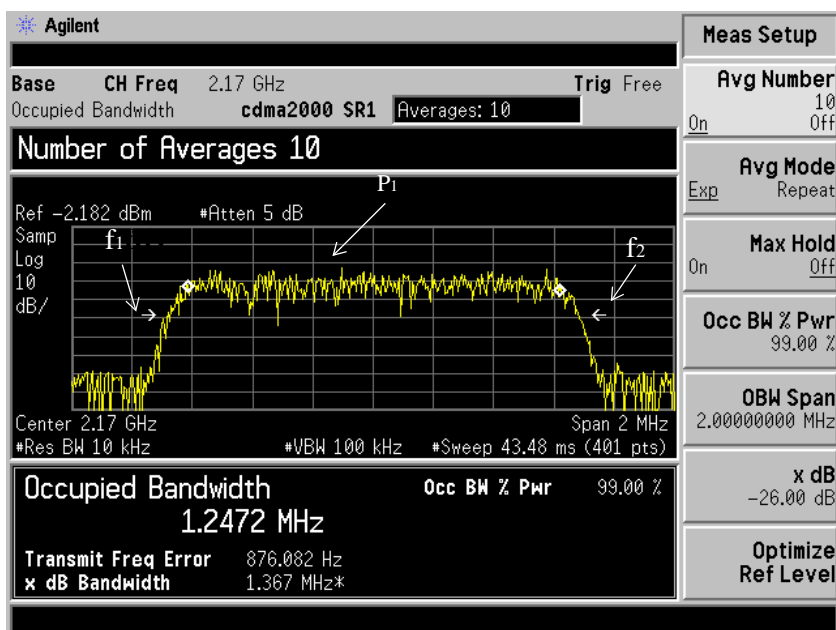

TIP **ESA Only:** This function looks similar to the N dB Points function found under the Peak Search front-panel key. However, the N dB Points arrows are referenced to the active marker, usually placed on a signal peak, and the frequency difference between the two arrows will be displayed in the upper right corner of the display. Whereas, the EBW indicated by the arrows x dB are referenced to the OBW power calculation integration of the power in the displayed spectrum.

Key Path: **Meas Setup**
 State Saved: Saved in instrument state.
 Factory Preset: -26 dB
 Default Terminator: dB
 Range: -100.0 dB through -0.1 dB

Remote Command:

```
[ :SENSe ] :OBW :XDB <dB value>
[ :SENSe ] :OBW :XDB ?
```

Example: OBW :XDB -50 dB
 OBW :XDB ?

2.18.7 Optimize Ref Level

PSA Only: Sets the input attenuator to optimize the robustness of the measurement, which is its freedom from errors due to input compression.

ESA Only: Sets the input attenuator and reference level to optimize the robustness of the measurement, which is its freedom from errors due to input compression and log amp range limitations.

NOTE There will always be a minimum of 2 dB for PSA or 5 dB for ESA of attenuation set to protect the analyzer input.

Key Path: **Meas Setup**
 State Saved: Saved in instrument state.
 Factory Preset: n/a

Remote Command:

```
[ :SENSe ] :POWer [ :RF ] :RANGe :AUTO ONCE
```

Example: POW :RANG :AUTO ONCE

One-Button Measurement Functions
Meas Setup (Occupied Bandwidth—OBW)

2.19 Meas Setup (Spectrum Emissions Mask—SEM)

When the spectrum emissions mask measurement has been selected in the Measure menu of the Spectrum Analysis Mode, this key displays the appropriate measurement setup menu.

Spectrum Emissions Mask (SEM) measurement includes the in-band and out-of-band spurious emissions. As it applies to W-CDMA (3GPP), this is the power contained in a specified frequency bandwidth at certain offsets relative to the total carrier power. It may also be expressed as a ratio of power spectral densities between the carrier and the specified offset frequency band.

Key Path: Front-panel key

History: Updated with PSA firmware revision A.08.00
 Updated with PSA firmware revision A.03.00
 Added with PSA firmware revision A.02.00
 Updated with ESA firmware revision A.09.00
 Added with ESA firmware revision A.08.00

2.19.1 Avg Number

Press **Avg Number (On)** to specify the number of measurement averages used when calculating the measurement result. The average will be displayed at the end of each sweep.

Key Path: **Meas Setup**

State Saved: Saved in instrument state.

Factory Preset: 10 averages / Off

Range: 1 through 1000

Remote Command:

```
[ :SENSe ] : SEMask : AVERage : COUNT <integer>
[ :SENSe ] : SEMask : AVERage : COUNT?

[ :SENSe ] : SEMask : AVERage [ :STATe ] OFF | ON | 0 | 1
[ :SENSe ] : SEMask : AVERage [ :STATe ] ?

Example:            SEM : AVER : COUN 15
                      SEM : AVER 1
```

2.19.2 Meas Type

Displays a menu where you can select a measurement reference type, **Total Pwr Ref** or **PSD Ref**.

Key Path: **Meas Setup**

Factory Preset: Total Pwr Ref

Remote Command:

```
[ :SENSE ] :SEMask :TYPE TPreRef | PSDRef
```

```
[ :SENSE ] :SEMask :TYPE?
```

Example: SEM:TYPE TPreRef or SEM:TYPE PSDRef

```
SEM:TYPE?
```

2.19.2.1 Total Pwr Ref

When **Total Pwr Ref** is selected, the power in the carrier is used as the reference in computing the relative power values for the offsets.

Key Path: **Meas Setup, Meas Type**

History: Updated with PSA firmware revision A.03.00

Updated with ESA firmware revision A.09.00

2.19.2.2 PSD Ref

When **PSD Ref** is selected, the mean power spectral density of the carrier is used in computing the relative power spectral density values for the offsets.

(PSA Only): Pressing the PSD Ref key allows you to configure the PSD reference used to calculate SEM for the offsets, either dBm/Hz or dBm/MHz

Key Path: **Meas Setup, Meas Type**

Factory Preset: dBm/Hz

History: Updated with PSA firmware revision A.06.00

Updated with ESA firmware revision A.09.00

(Note: units of dBm/Hz or dBm/MHz are not selectable in ESA)

Remote Command:

```
:UNIT:SEMask:POWer:PSD DBMHZ | DBMMHZ
```

```
:UNIT:SEMask:POWer:PSD?
```

Example: UNIT:SEM:POW:PSD DBMMHZ

2.19.3 Ref Channel

Accesses the menu of keys that enable you to change the reference channel settings.

Key Path: **Meas Setup**

2.19.3.1 Chan Integ BW

Specifies the integration bandwidth used in calculating the power in the main channel.

Key Path: **Meas Setup, Ref Channel**

Factory Preset: 3.84 MHz

Range: 10% to 100% of the setting of Chan Span

Remote Command:

```
[ :SENSe] :SEMAsk:BAWIDth[n] | BWIDth[n] :INTEgration <number>
```

```
[ :SENSe] :SEMAsk:BAWIDth[n] | BWIDth[n] :INTEgration?
```

Example: SEM:BAWID[n] :INT 4 MHz

```
SEM:BWID[n] :INT 4 MHz
```

```
SEM:BAWID[n] :INT?
```

```
SEM:BWID[n] :INT?
```

2.19.3.2 Chan Span

Specifies the span used in measuring the power in the main channel.

Key Path: **Meas Setup, Ref Channel**

Factory Preset: 5 MHz

Knob Increment: 1% of the set span.

Range: 1 kHz to 10 MHz

Remote Command:

```
[ :SENSe] :SEMAsk:FREQuency:SPAN <number>
```

```
[ :SENSe] :SEMAsk:FREQuency:SPAN?
```

Example: SEM:FREQ:SPAN 4 MHz

```
SEM:FREQ:SPAN?
```

2.19.3.3 Sweep Time

Specifies the sweep time used in measuring the power in the main channel.

Key Path: **Meas Setup, Ref Channel**

Factory Preset: Auto/On

Range: PSA: 1 ms through 2 ks

ESA: 1 ms through 4 ks

Remote Command:

```
[ :SENSe] :SEMAsk :SWEeptime <number>
```

```
[ :SENSe] :SEMAsk :SWEeptime?
```

```
[ :SENSe] :SEMAsk :SWEeptime :AUTO OFF | ON | 0 | 1
```

```
[ :SENSe] :SEMAsk :SWEeptime :AUTO?
```

Example: SEM:SWE 4 s
SEM:SWE?
SEM:SWE:AUTO 1
SEM:SWE:AUTO?

2.19.3.4 Res BW

Specifies the resolution bandwidth used in measuring and the power in the main channel.

Key Path: **Meas Setup, Ref Channel**

Factory Preset: PSA: 75 kHz

ESA: 30 kHz

Range: Full Range provided by Base Instrument Hardware.

History: Remote command updated with ESA firmware revision A.09.00

Remote command updated with PSA firmware revision A.03.00

Remote Command:

```
[ :SENSe] :SEMAsk :BANDwidth | BWIDth [ :RESolution] <freq>
```

```
[ :SENSe] :SEMAsk :BANDwidth | BWIDth [ :RESolution] ?
```

```
[ :SENSe] :SEMAsk :BANDwidth | BWIDth [ :RESolution] :AUTO OFF | ON | 0 | 1
```

```
[ :SENSe] :SEMAsk :BANDwidth | BWIDth [ :RESolution] :AUTO?
```

Remote Command Notes: See Volume 1, *Core Spectrum Analyzer Functions User's and Programmer's Reference* guide.

Example: SEM:BAND 4 MHz

```
SEM:BWID 4 MHz
SEM:BAND?
SEM:BWID?
```

```
SEM:BAND:AUTO 1
SEM:BWID:AUTO 1
SEM:BAND:AUTO?
SEM:BWID:AUTO?
```

2.19.3.5 Total Pwr Ref or PSD Ref

Displays the type of power measurement reference selected using the **Meas Type** key (see “[Meas Type](#)” on page 172).

Total Pwr Ref is the power in the carrier that is used as the reference in computing the relative power values for the offsets. When **Man** is selected, this can be set by the user. When **Auto** is selected, this is the measured power in the reference carrier.

PSD Ref is the mean power spectral density in the carrier that is used as the reference in computing the relative power spectral density values for the offsets. When **Man** is selected, this can be set by the user, when **Auto** is selected, this is the measured mean power spectral density in the reference carrier.

Key Path: **Meas Setup, Ref Channel**

Factory Preset: 0.00 dBm/Off

Range: –200.0 dBm to 200.0 dBm.

Remote Command:

```
[ :SENSe ] :SEMAsk:CARRier[:POWer] <ampl>
```

```
[ :SENSe ] :SEMAsk:CARRier[:POWer] ?
```

```
[ :SENSe ] :SEMAsk:CARRier:AUTO[:STATe] OFF|ON|0|1
```

```
[ :SENSe ] :SEMAsk:CARRier:AUTO[:STATe] ?
```

Example: SEM:CARR 0 dBm

```
SEM:CARR?
```

```
SEM:CARR:AUTO 1
```

```
SEM:CARR:AUTO?
```

2.19.4 Offset/Limits

Displays the menus where you can change the parameters for offset frequency settings and pass/fail tests. Refer to the tables below for default settings of particular radio standards of interest.

Table 2-1 Offsets & Limits Defaulted for W-CDMA (3GPP) Base Station Measurements

Offset	Start Freq (MHz)	Stop Freq (MHz)	Sweep Time (μs)	Res BW (kHz)	Abs Start (dBm)	Abs Stop (dBm)	Abs Couple	Rel Start (dBc)	Rel Stop (dBc)	Rel Couple	Fail Mask	Meas BW
A, On	2.515	2.715	Auto	30.0	-14.0	-14.0	Couple	-30.0	-30.0	Couple	Abs	1
B, On	2.715	3.515	Auto	30.0	-14.0	-26.0	Man	-30.0	-30.0	Couple	Abs	1
C, On	3.515	4.000	Auto	30.0	-26.0	-26.0	Couple	-30.0	-30.0	Couple	Abs	1
D, On	4.000	8.000	Auto	1000.0 30.0	-13.0	-13.0	Couple	-30.0	-30.0	Couple	Abs	1 33
E, On	8.000	12.500	Auto	1000.0	-13.0	-13.0	Couple	-30.0	-30.0	Couple	Abs	1
F, Off	12.500	15.000	Auto	1000.0	-13.0	-13.0	Couple	-30.0	-30.0	Couple	Abs	1 33

Table 2-2 Offsets & Limits Defaulted for W-CDMA (3GPP) Mobile Station Measurements

Offset	Start Freq (MHz)	Stop Freq (MHz)	Sweep Time (μs)	Res BW (kHz)	Abs Start (dBm)	Abs Stop (dBm)	Abs Couple	Rel Start (dBc)	Rel Stop (dBc)	Rel Couple	Fail Mask	Meas BW
A, On	2.515	3.485	Auto	30.0	-71.07	-71.07	Couple	-35.23	-49.78	Man	AND	1
B, On	4.000	7.500	Auto	1000.0	-55.84	-55.84	Couple	-35.50	-39.00	Man	AND	1
C, On	7.500	8.500	Auto	1000.0	-55.84	-55.84	Couple	-39.00	-49.00	Man	AND	1
D, On	8.500	12.000	Auto	1000.0	-55.84	-55.84	Couple	-49.00	-49.00	Couple	AND	1
E, Off	12.500	15.000	Auto	1000.0	-55.84	-55.84	Couple	-49.00	-49.00	Couple	AND	1
F, Off	12.500	15.000	Auto	1000.0	-55.84	-55.84	Couple	-49.00	-49.00	Couple	AND	1

Table 2-3 Offsets & Limits Defaulted for 802.11a, 802.11g, and HiperLAN/2 Radio Standards

Offset	Start Freq (MHz)	Stop Freq (MHz)	Sweep Time (ms)	Res BW (kHz)	Abs Start (dBm)	Abs Stop (dBm)	Abs Couple	Rel Start (dBc)	Rel Stop (dBc)	Rel Couple	Fail Mask	Meas BW
A, On	9.0	11.0	100	100	16.0	-4.0	Man	0.0	-20.0	Man	Rel	1
B, On	11.0	20.0	100	100	-4.0	-12.0	Man	-20.0	-28.0	Man	Rel	1
C, On	20.0	30.0	100	100	-12.0	-24.0	Man	-28.0	-40.0	Man	Rel	1
D, On	30.0	50.0	100	100	-24.0	-24.0	Couple	-40.0	-40.0	Couple	Rel	1
E, Off	50.0	100.0	100	100	-24.0	-24.0	Couple	-40.0	-40.0	Couple	Rel	1
F, Off	216.0	250.0	100	100	-24.0	-24.0	Couple	-47.0	-47.0	Couple	Rel	1

Table 2-4 Offsets & Limits Defaulted for 802.11b

Offset	Start Freq (MHz)	Stop Freq (MHz)	Sweep Time (ms)	Res BW (kHz)	Abs Start (dBm)	Abs Stop (dBm)	Abs Couple	Rel Start (dBc)	Rel Stop (dBc)	Rel Couple	Fail Mask	Meas BW
A, On	11.0	22.0	100	100	-10.0	-10.0	Couple	-30.0	-30.0	Couple	Rel	1
B, On	22.0	50.0	100	100	-30.0	-30.0	Couple	-50.0	-50.0	Couple	Rel	1
C, On	50.0	70.0	100	100	-30.0	-30.0	Couple	-50.0	-50.0	Couple	Rel	1
D, On	70.0	90.0	100	100	-30.0	-30.0	Couple	-50.0	-50.0	Couple	Rel	1
E, Off	90.0	100.0	100	100	-30.0	-30.0	Couple	-50.0	-50.0	Couple	Rel	1
F, Off	100.0	120.0	100	100	-30.0	-30.0	Couple	-50.0	-50.0	Couple	Rel	1

2.19.4.1 Offset

Selects the offset pairs (upper and lower) that the menu keys affect, and displays the memory selection menu from **A** to **E** for ESA, or **A** to **F** for PSA (where you can store up to 6 sets of values for **Start Freq**, **Stop Freq**, **Sweep Time**, **Res BW**, **Meas BW**, **Abs Start**, **Abs Stop**, and so forth). Press **Offset** until the letter of the desired offset (A, B, C, D, E, or F) is underlined. Only one selection at a time is shown on this key label.

For PSA only: Since the display can show only five results at one time, the **Results Index** key allows you to scroll to the sixth result when all offsets are active.

Key Path: **Meas Setup, Offset/Limits**

State Saved: Saved in instrument state.

Factory Preset: A

Remote Command:

There is no remote command for this function.

2.19.4.2 Start Freq

Specifies the inner limit (frequency closest to the carrier) for both segments of the specified offset pair. When **Start Freq** (Off) is selected, the offset pair is not measured.

Key Path: **Meas Setup, Offset/Limits**

State Saved: Saved in instrument state.

Factory Preset: Dependent upon Radio Standard and device selected, refer to the default tables for “Offset/Limits” on page 175 for this value.

Default Terminator: Hz

Range: 0 Hz to 500 MHz

Remote Command:

[:SENSE] :SEMAsk:OFFSet [n] :LIST:FREQUency:START <freq>, ... [<freq>]
(up to five values)

[:SENSE] :SEMAsk:OFFSet [n] :LIST:FREQUency:START?

[:SENSE] :SEMAsk:OFFSet [n] :LIST:STATe OFF|ON|0|

[:SENSE] :SEMAsk:OFFSet [n] :LIST:STATe?

Remote Command Notes: Comma separated list. When offset F is off, this will be 5 values. When offset F is on, this will be 6 values. n = 1 for BTS and n = 2 for MS. Default is BTS.

Offsets that are turned off, for the currently selected offset will return a -999.0 when queried.

Example: SEM:OFFS:LIST:FREQ:STAR 2 MHz
 SEM:OFFS:LIST:FREQ:STAR?
 SEM:OFFS:LIST:STAT 1
 SEM:OFFS:LIST:STAT?

2.19.4.3 Stop Freq

Specifies the outer limit (frequency furthest from the carrier) for both segments of the specified offset pair. The lower range is limited to the setting of **Start Freq**.

Key Path: **Meas Setup, Offset/Limits**

State Saved: Saved in instrument state.

Factory Preset: Dependent upon Radio Standard and device selected, refer to the default tables for “[Offset/Limits](#)” on page 175 for this value.

Default Terminator: Hz

Range: 0 Hz to 500 MHz

Remote Command:

[:SENSe] :SEMAsk:OFFSet [n] :LIST:FREQuency:STOP <freq> . . . [<freq>]
 (up to five values)

[:SENSe] :SEMAsk:OFFSet [n] :LIST:FREQuency:STOP?

Remote Command Notes: Comma separated list. When offset F is off, this will be 5 values. When offset F is on, this will be 6 values. n = 1 for BTS and n = 2 for MS. Default is BTS.

Example: SEM:OFFS:LIST:FREQ:STOP 4 MHz
 SEM:OFFS:LIST:FREQ:STOP?

2.19.4.4 Sweep Time

Specifies the sweep time for the currently selected offset, and toggles this function between **Auto** and **Manual** for each offset.

Key Path: **Meas Setup, Offset/Limits**

State Saved: Saved in instrument state.

Factory Preset: Dependent upon Radio Standard and device selected, refer to the default tables for “[Offset/Limits](#)” on page 175 for this value.

Default Terminator: s (seconds)

Range: 1 ms to 42 ks

One-Button Measurement Functions

Meas Setup (Spectrum Emissions Mask—SEM)

Remote Command:

```
[[:SENSe]:SEMAsk:OFFSet[n]:LIST:SWEeptime <time>... [<time>]  
(up to five values)
```

```
[[:SENSe]:SEMAsk:OFFSet[n]:LIST:SWEeptime?
```

```
[[:SENSe]:SEMAsk:OFFSet[n]:LIST:SWEeptime:AUTO OFF|ON|0|1
```

```
[[:SENSe]:SEMAsk:OFFSet[n]:LIST:SWEeptime:AUTO?
```

Remote Command Notes: Comma separated list. When offset F is off, this will be 5 values. When offset F is on, this will be 6 values. n = 1 for BTS and n = 2 for MS. Default is BTS.

Example:

```
SEM:OFFS:LIST:SWE:AUTO 4 ms  
SEM:OFFS:LIST:SWE:AUTO?  
SEM:OFFS:LIST:SWE 4 ms  
SEM:OFFS:LIST:SWE?
```

2.19.4.5 Res BW

Specifies the resolution bandwidth used in measuring the offset pair. When set to Auto, the Res BW from the default tables for “Offset/Limits” on page 175 are used. When set to Man, the range of settings is the range of available Res BWs of the analyzer, except the maximum is further limited to not exceed (Stop Freq - Start Freq).

Key Path: **Meas Setup, Offset/Limits**

State Saved: Saved in instrument state.

Factory Preset: Dependent upon Radio Standard and device selected, refer to the default tables for “Offset/Limits” on page 175 for this value.

Default Terminator: Hz

Remote Command:

```
[[:SENSe]:SEMAsk:OFFSet[n]:LIST:BANDwidth|BWIDth[:RESolution]  
<freq>... [<freq>] (up to five values)
```

```
[[:SENSe]:SEMAsk:OFFSet[n]:LIST:BANDwidth|BWIDth[:RESolution]?
```

```
[[:SENSe]:SEMAsk:OFFSet[n]:LIST:BANDwidth|BWIDth[:RESolution]:AUTO  
OFF|ON|0|1
```

```
[[:SENSe]:SEMAsk:OFFSet[n]:LIST:BANDwidth|BWIDth[:RESolution]:AUTO?
```

Remote Command Notes: Comma separated list. When offset F is off, this will be 5 values. When offset F is on, this will be 6 values. n = 1 for BTS and n = 2 for MS. Default is BTS.

You may only enter valid Res BW filter frequencies.

See Volume 1, *Core Spectrum Analyzer Functions User's and Programmer's Reference* guide.

Example: SEM:OFFS:LIST:BAND 40 kHz or SEM:OFFS:LIST:BWID 40 kHz
 SEM:OFFS:LIST:BAND? or SEM:OFFS:LIST:BWID?
 SEM:OFFS:LIST:BAND:AUTO 0 or SEM:OFFS:LIST:BWID:AUTO 0
 SEM:OFFS:LIST:BAND:AUTO? or SEM:OFFS:LIST:BWID:AUTO?

2.19.4.6 Meas BW

Enables you to specify the bandwidth to use when measuring the offset. When using the front panel, only the currently selected offset is affected. All the offsets are affected when using the remote command. This is the multiplier applied to the resolution bandwidth to determine the bandwidth to integrate when calculating the power.

Key Path: **Meas Setup, Offset/Limits**

Key Notes: The 3GPP standard allows for the construction of an effective measurement bandwidth out of a group of narrower resolution bandwidths. This allowance is a remedy for the potential loss in dynamic range which can occur when carrier energy leaks into the offset due to the RBW filter's shape factor (nominally 12:1). When the offset's ratio of start frequency to the Meas BW is small (approximately 4:1), it is recommended that you select a small Res BW value (30 kHz) and a large multiplier (Meas BW=33) in order to increase the dynamic range of the measurement. Refer to offset D in [Table 2-1 on page 176](#).

When setting Meas BW > 1, dynamic range is increased, however measurement time is also increased since an increased number of sweep points are required to make the measurement. For Meas BW > 1, consider this equation for trace points:

$$\text{Trace points} = (\text{Offset Stop Freq} - \text{Offset Start Freq}) / (\text{Meas BW}/100)$$

When Meas BW = 1, the number of trace points are set at the value specified upon entering the measurement.

Dependencies/
 Couplings: This parameter must adhere to the rule: $(N \times \text{Res BW}) \leq (\text{Stop Freq of the offset} - \text{Start freq of the offset})$, where N is Meas BW value. If the Res BW is changed, Meas BW will change to ensure this rule.

State Saved: Saved in instrument state.

Factory Preset: Dependent upon Radio Standard and device selected, refer to the default tables for "Offset/Limits" on [page 175](#) for this value.

One-Button Measurement Functions

Meas Setup (Spectrum Emissions Mask—SEM)

Default Terminator: x Res BW

Knob Increment: 1

Step Key

Increment: 1

Range: 1 to 1000

History: Added with PSA firmware revision A.02.00

Added with ESA firmware revision A.09.00

Remote Command:

```
[ :SENSE ] :SEMAsk:OFFSet [n] :LIST:BANDwidth|BWIDth:IMULti <integer>
```

```
[ :SENSE ] :SEMAsk:OFFSet [n] :LIST:BANDwidth|BWIDth:IMULti?
```

```
[ :SENSE ] :SEMAsk:OFFSet [n] :LIST:BANDwidth|BWIDth[:RESolution]:AUTO  
OFF|ON|0|1
```

```
[ :SENSE ] :SEMAsk:OFFSet [n] :LIST:BANDwidth|BWIDth[:RESolution]:AUTO?
```

Remote Command Notes: Comma separated list. When offset F is off, this will be 5 values. When offset F is on, this will be 6 values. n = 1 for BTS and n = 2 for MS. Default is BTS.

Example: SEM:OFFS:LIST:BAND:IMUL 40 or SEM:OFFS:LIST:BWID:IMUL 40

SEM:OFFS:LIST:BAND:IMUL? or SEM:OFFS:LIST:BWID:IMUL?

SEM:OFFS:LIST:BAND:AUTO 0 or SEM:OFFS:LIST:BWID:AUTO 0

SEM:OFFS:LIST:BAND:AUTO? or SEM:OFFS:LIST:BWID:AUTO?

2.19.4.7 Abs Start

Enables you to enter an absolute level limit at **Start Freq** for the currently selected offset ranging from -200.00 to +50.00 dBm with 0.01 dB resolution.

Key Path: **Meas Setup, Offset/Limits**

State Saved: Saved in instrument state.

Factory Preset: Dependent upon Radio Standard and device selected, refer to the default tables for “Offset/Limits” on page 175 for this value.

Default Terminator: dBm

Range: -200 dBm to 50 dBm

Remote Command:

```
[ :SENSE ] :SEMAsk:OFFSet [n] :LIST:START:ABSolute <ampl>, ... [<ampl>] (up to
```

five values)

```
[ :SENSe] :SEMAsk:OFFSet [n] :LIST:STARt:ABSolute?
```

Remote Command Notes: Comma separated list. When offset F is off, this will be 5 values. When offset F is on, this will be 6 values. n = 1 for BTS and n = 2 for MS. Default is BTS.

```
Example: SEM:OFFS:LIST:STAR:ABS -20 dBm
SEM:OFFS:LIST:STAR:ABS
```

2.19.4.8 Abs Stop

Enables you to enter an absolute level limit at **Stop Freq** for the currently selected offset ranging from -200.00 to +50.00 dBm with 0.01 dB resolution, and to toggle this function between **Couple** and **Man**. If set to **Couple**, this is coupled to **Abs Start** to make a flat limit line. If set to **Man**, **Abs Start** and **Abs Stop** you can enter different values to make a sloped limit line.

Key Path: **Meas Setup, Offset/Limits**

State Saved: Saved in instrument state.

Factory Preset: Dependent upon Radio Standard and device selected, refer to the default tables for “Offset/Limits” on page 175 for this value.

Default Terminator: dBm

Range: -200 dBm to 50 dBm

Remote Command:

```
[ :SENSe] :SEMAsk:OFFSet [n] :LIST:STOP:ABSolute <ampl>, ... [<ampl>]
(up to five values)
```

```
[ :SENSe] :SEMAsk:OFFSet [n] :LIST:STOP:ABSolute?
```

```
[ :SENSe] :SEMAsk:OFFSet [n] :LIST:STOP:ABSolute:COUple OFF|ON|0|1
```

```
[ :SENSe] :SEMAsk:OFFSet [n] :LIST:STOP:ABSolute:COUple?
```

Remote Command Notes: Comma separated list. When offset F is off, this will be 5 values. When offset F is on, this will be 6 values. n = 1 for BTS and n = 2 for MS. Default is BTS.

```
Example: SEM:OFFS:LIST:STOP:ABS -20 dBm
SEM:OFFS:LIST:STOP:ABS
SEM:OFFS:LIST:STOP:ABS:COUP 0
SEM:OFFS:LIST:STOP:ABS:COUP?
```

2.19.4.9 Rel Start

Enables you to enter a relative level limit at **Start Freq** ranging from -150.00 to +50.00 dBc with 0.01 dB resolution.

One-Button Measurement Functions

Meas Setup (Spectrum Emissions Mask—SEM)

Key Path: **Meas Setup, Offset/Limits, More**

State Saved: Saved in instrument state.

Factory Preset: Dependent upon Radio Standard and device selected, refer to the default tables for “Offset/Limits” on page 175 for this value.

Default Terminator: dB

Range: –200 dB to 50 dB

Remote Command:

```
[ :SENSE ] :SEMAsk:OFFSet [n] :LIST:START:RCARrier <rel_ampl>, ... [<rel_ampl>]  
(up to five values)
```

```
[ :SENSE ] :SEMAsk:OFFSet [n] :LIST:START:RCARrier?
```

Remote Command Notes: Comma separated list. When offset F is off, this will be 5 values. When offset F is on, this will be 6 values. n = 1 for BTS and n = 2 for MS. Default is BTS.

Example: SEM:OFFS:LIST:STAR:RCAR -20 dB
SEM:OFFS:LIST:STAR:RCAR

2.19.4.10 Rel Stop

Enables you to enter a relative level limit at **Stop Freq** ranging from –150.00 to +50.00 dBc with 0.01 dB resolution, and to toggle this function between **Couple** and **Man**. If set to **Couple**, this is coupled to **Rel Start** to make a flat limit line. If set to **Man**, **Rel Start** and **Rel Stop** you can enter different values to make a sloped limit line.

Key Path: **Meas Setup, Offset/Limits, More**

State Saved: Saved in instrument state.

Factory Preset: Dependent upon Radio Standard and device selected, refer to the default tables for “Offset/Limits” on page 175 for this value.

Default Terminator: dB

Range: –200 dB to 50 dB

Remote Command:

```
[ :SENSE ] :SEMAsk:OFFSet [n] :LIST:STOP:RCARrier <real number>, [<real number>] ...
```

```
[ :SENSE ] :SEMAsk:OFFSet [n] :LIST:STOP:RCARrier?
```

```
[ :SENSE ] :SEMAsk:OFFSet [n] :LIST:STOP:RCARrier:COUple OFF|ON|0|1
```

```
[ :SENSE ] :SEMAsk:OFFSet [n] :LIST:STOP:RCARrier:COUple?
```

Remote Command Notes: Comma separated list. When offset F is off, this will be 5 values. When offset F is on, this will be 6 values. n = 1 for BTS and n = 2 for MS. Default is BTS.

Example: SEM:OFFS:LIST:STOP:RCAR -20 dBm

```
SEM:OFFS:LIST:STOP:RCAR
SEM:OFFS:LIST:STOP:RCAR:COUP 0
SEM:OFFS:LIST:STOP:RCAR:COUP?
```

2.19.4.11 Fail Mask

Displays the menu to select one of the following logic keys for fail conditions between the measurement results and the test limits: **Absolute**, **Relative**, **Abs AND Rel**, and **Abs OR Rel**.

Absolute - Fail is shown if one of the absolute spectrum emission mask measurement results is larger than the limit between **Abs Start** and **Abs Stop**, inclusive. This is the default selection for each offset for BTS measurements.

Relative - Fail is shown if one of the relative spectrum emission mask measurement results is larger than the limit between **Rel Start** and **Rel Stop**, inclusive.

Abs AND Rel - Fail is shown if one of the absolute spectrum emission mask measurement results is larger than the limit between **Abs Start** and **Abs Stop**, inclusive AND one of the relative spectrum emission mask measurement results is larger than the limit for **Rel Start** and **Rel Stop**. This is the default for MS measurements.

Abs OR Rel - Fail is shown if one of the absolute spectrum emission mask measurement results is larger than the limit between **Abs Start** and **Abs Stop**, inclusive OR one of the relative spectrum emission mask measurement results is larger than the limit for **Rel Start** and **Rel Stop**.

Key Path: **Meas Setup, Offset/Limits, More**

State Saved: Saved in instrument state.

Factory Preset: Dependent upon Radio Standard and device selected, refer to the default tables for “[Offset/Limits](#)” on page 175 for this value.

Remote Command:

```
[ :SENSe ] :SEMAsk:OFFSet [n] :LIST:TEST
ABSolute|AND|OR|RELative,ABSolute|AND|OR|RELative,ABSolute|AND|OR|RELative
,ABSolute|AND|OR|RELative
```

```
[ :SENSe ] :SEMAsk:OFFSet [n] :LIST:TEST?
```

Remote Command Notes: Comma separated list. When offset F is off, this will be 5 values. When offset F is on, this will be 6 values. n = 1 for BTS and n = 2 for MS. Default is BTS.

Example: SEM:OFFS:LIST:TEST ABS,REL,ABS AND REL,ABS OR REL
SEM:OFFS:LIST:TEST?

2.19.4.11.1 Absolute

Set the limit test to show Fail if one of the absolute spectrum emission mask measurement results is larger than the limit for **Abs Start** and/or **Abs Stop**. This is the default selection for each offset

Key Path: **Meas Setup, Offset/Limits, More, Fail Mask**

State Saved: Saved in instrument state.

One-Button Measurement Functions
Meas Setup (Spectrum Emissions Mask—SEM)

Factory Preset: Dependent upon Radio Standard and device selected, refer to the default tables for “Offset/Limits” on page 175 for this value.

Remote Command:

Refer to “Fail Mask” on page 185.

2.19.4.11.2 Relative

Sets the limit test to show Fail if one of the relative spectrum emission mask measurement results is larger than the limit for **Rel Start** and/or **Rel Stop**.

Key Path: **Meas Setup, Offset/Limits, More, Fail Mask**

State Saved: Saved in instrument state.

Factory Preset: Dependent upon Radio Standard and device selected, refer to the default tables for “Offset/Limits” on page 175 for this value.

Remote Command:

Refer to “Fail Mask” on page 185.

2.19.4.11.3 Abs AND Rel

Set the limit test to show Fail if one of the absolute spectrum emission mask measurement results is larger than the limit for **Abs Start** and **Abs Stop** *AND* one of the relative spectrum emission mask measurement results is larger than the limit for **Rel Start** and **Rel Stop**.

Key Path: **Meas Setup, Offset/Limits, More, Fail Mask**

State Saved: Saved in instrument state.

Factory Preset: Dependent upon Radio Standard and device selected, refer to the default tables for “Offset/Limits” on page 175 for this value.

Remote Command:

Refer to “Fail Mask” on page 185.

2.19.4.11.4 Abs OR Rel

Set the limit test to show Fail if one of the absolute spectrum emission mask measurement results is larger than the limit for **Abs Start** and **Abs Stop** *OR* one of the relative spectrum emission mask measurement results is larger than the limit for **Rel Start** and **Rel Stop**.

Key Path: **Meas Setup, Offset/Limits, More, Fail Mask**

State Saved: Saved in instrument state.

Factory Preset: Dependent upon Radio Standard and device selected, refer to the default tables for “Offset/Limits” on page 175 for this value.

Remote Command:

Refer to “Fail Mask” on page 185.

2.19.5 Results Index (PSA only)

Used to view the sixth result when all offsets are active. Since the display can show only five results at one time, this key allows you to scroll to the last result.

Key Path:	Meas Setup
State Saved:	Saved in instrument state.
Factory Preset:	1
Knob Increment:	1
Step Key Increment:	1
Range:	1 to 6
History:	Added with firmware revision A.08.00

Remote Command:

[:SENSe] :SEMask:RESult

Example: SENS:SEM:RES

2.19.6 Optimize Ref Level

Sets the input attenuator and reference level to optimize the robustness of the measurement, which is its freedom from errors due to input compression and log amp range limitations.

NOTE There is always a minimum of 2 dB for PSA or 5 dB for ESA of attenuation set to protect the analyzer input.

Key Path:	Meas Setup
State Saved:	Saved in instrument state.

Remote Command:

[:SENSe] :POWer [:RF] :RANGe:AUTO ONCE

Example: POW:RANG:AUTO ONCE

2.19.7 RRC Filter

Pressing **RRC Filter** turns the Root Raised Cosine filter on or off. This filter is the type specified in the 3GPP W-CDMA standards. This parameter is only available when **3GPP W-CDMA** is selected as the **Radio Std** from the **Mode Setup** menu. If **3GPP W-CDMA** is selected, the rolloff value (alpha) for the filter will be initially set to 0.22 and T will be 260 ns. The rolloff value can be changed using **Filter Alpha**.

Key Path:	Meas Setup
State Saved:	Saved in instrument state.

One-Button Measurement Functions

Meas Setup (Spectrum Emissions Mask—SEM)

Factory Preset: Off
History: Added with PSA firmware revision A.03.00.
Added with ESA firmware revision A.09.00.

Remote Command:

```
[ :SENSe] :SEMAsk:FILTeR [ :RRC] [ :STATe] OFF|ON|0|1
```

```
[ :SENSe] :SEMAsk:FILTeR [ :RRC] [ :STATe] ?
```

Example: SEM:FILT 1
SEM:FILT?

2.19.8 Filter Alpha

Press **Filter Alpha** to input the alpha value for the RRC Filter. This parameter is only available when **3GPP W-CDMA** is selected as the Radio Std. from the Mode Setup menu.

Key Path: **Meas Setup**
State Saved: Saved in instrument state.
Factory Preset: 0.22 when W-CDMA is selected, otherwise Off.
Knob Increment: 0.01
Step Key
Increment: 0.1
Range: 0.01 to 1.0
History: Added with PSA firmware revision A.03.00.
Added with ESA firmware revision A.09.00.

Remote Command:

```
[ :SENSe] :SEMAsk:FILTeR [ :RRC] :ALPHA <number>
```

```
[ :SENSe] :SEMAsk:FILTeR [ :RRC] :ALPHA?
```

2.20 Display (Spectrum Emissions Mask—SEM)

Displays menu keys that enable you to configure parameters for the SEM measurement.

NOTE The keys described below are measurement dependent. To access the display menus, for the SEM measurement press **MEASURE**, **Spectrum Emission Mask**, then **Display**.

2.20.1 Full Screen

Expands the measurement window horizontally over the entire instrument display. Pressing any other key that results in a new menu cancels the full screen function.

Key Path: **Display**

State Saved: Not saved in state.

Factory Preset: Off

Factory
Default: Off

History: Added with PSA firmware revision A.02.00
Added with ESA firmware revision A.08.00

2.20.2 Limit Display

Allows you to toggle the limit lines display function for spectrum emission mask measurements between on and off. If set to **On**, the absolute limit lines and the relative limit lines are shown on the spectrum emission mask measurement display.

Key Path: **Display, Limit Display**

State Saved: Saved in instrument state.

Factory Preset: On

History: Added with PSA firmware revision A.02.00
Added with ESA firmware revision A.08.00

2.20.3 Preferences

Displays menu keys that enable you to turn the graticule and annotation on or off.

Key Path: **Display**

State Saved: Saved in instrument state.

One-Button Measurement Functions

Display (Spectrum Emissions Mask—SEM)

History: Added with PSA firmware revision A.02.00
Added with ESA firmware revision A.08.00

2.20.3.1 Graticule (On Off)

Pressing Graticule turns the display graticules on or off.

Key Path: **Display, Preferences**

Factory Preset: On

Factory
Default: On

Terminators: **Enter**

History: Added with PSA firmware revision A.02.00
Added with ESA firmware revision A.08.00

2.20.3.2 Annotation (On Off)

Turns the screen annotation on or off, however, menu key annotation will remain on the display. The screen annotation may not be required for prints or during remote operation.

Key Path: **Display**

Factory Preset
and *RST: On

Factory
Default: On

Terminators: **Enter**

History: Added with PSA firmware revision A.02.00
Added with ESA firmware revision A.08.00

2.21 Marker (Spectrum Emissions Mask—SEM)

Displays the Marker control menu for the SEM measurement. If no markers are active, **Marker** selects marker 1, sets it to **Normal** and places it to the right of the display. There are two control modes for the markers:

- **Normal (POSITION)** - A single marker that can be moved to any point on the trace.
- **Off (OFF)** - Turns off the active marker or marker pair.

Key Path: Front-panel key

State Saved: The control mode for each marker, as well as the position of each marker, is saved in instrument state.

Factory Preset: All Off.

Remote Command:

There is no equivalent remote command.

2.21.1 Select Marker

Selects one of the four possible markers. Once a marker is selected, it can be set to any of the control modes **Normal** or **Off**.

Key Path: **Marker**

State Saved: The number of the selected marker is saved in instrument state.

Factory Preset: Marker 1

History: Remote command updated with PSA firmware revision A.03.00

Remote command updated with ESA firmware revision A.09.00

Remote Command:

```
:CALCulate:SEMask:MARKer[1] | 2 | 3 | 4:STATe OFF | ON | 0 | 1
```

```
:CALCulate:SEMask:MARKer[1] | 2 | 3 | 4:STATe?
```

Remote Command Notes: Sets or queries the state of a marker. Setting a marker to state ON or 1 selects that marker. Setting a marker which is OFF to state ON or 1 puts it in **Normal** mode and places it on the screen to the right of the displayed measurement graph. Setting a marker to state OFF or 0 selects that marker and turns it off. The response to the query will be 0 if OFF, 1 if ON.

Example: CALC:SEM:MARK2:STAT ON selects marker 2.

CALC:SEM:MARK:STAT ON will not modify a marker that is already on.

2.21.2 Normal

Sets the control mode for the selected marker to **Normal** (see “[Select Marker](#)” on page 191). If the marker is off, a single marker is activated and placed on the screen to the right of the measurement graph. You can then adjust the trace point of the marker using the knob, numeric keypad, or ↑ ↓ keys.

Key Path: **Marker**

Factory Preset: Off

History: Remote command updated with PSA firmware revision A.03.00

Remote command updated with ESA firmware revision A.09.00

Remote Command:

See “[Marker \(Spectrum Emissions Mask—SEM\)](#)” on page 191 for the mode command.

Example: `CALC:SEM:MARK:STAT ON` selects marker 1 and sets it to **Normal**.

2.21.3 Off

Turns off the selected marker. In addition, **Off** also turns off functions related to the selected marker.

Key Path: **Marker**

Factory Preset: Off

History: Remote command updated with PSA firmware revision A.03.00

Remote command updated with ESA firmware revision A.09.00

Remote Command:

See “[Select Marker](#)” on page 191 for the command to select the control mode.

Example: `CALC:SEM:MARK3:STAT OFF` selects marker 3 and sets it to **Off**.

2.22 Trace/View (Spectrum Emissions Mask)

If **Spectrum Emission Mask** has been selected in the Measure menu of the Spectrum Analysis mode, this key displays the appropriate **Trace/View** menu for the spectrum emission mask (SEM).

Displays menu keys that enable you to set how trace information is stored and displayed.

Key Path: Front-panel key
History: Added with PSA firmware revision A.02.00
Added with ESA firmware revision A.08.00

Remote Command:

There is no remote command for this function.

2.22.1 Abs Pwr & Freq

Press **Abs Pwr & Freq** to view the measurement results of Spectrum (Ref: Total Pwr, Seg: Offset) measurements in the graph window as absolute peak power and frequency. The absolute peak power levels, in dBm and those corresponding offset frequency ranges on both sides of the reference channel are displayed in the text window.

Key Path: **Trace/View**
Saved State: Saved in instrument state.
Factory Preset: On
History: Added with ESA firmware revision A.07.00

Remote Command:

There is no remote command for this function.

2.22.2 Rel Pwr & Freq

Press **Rel Pwr & Freq** to view the measurement results of Spectrum (Ref: Total Pwr, Seg: Offset) measurements in the graph window as power relative to the carrier power and frequency. The relative power levels in dBc and those corresponding offset frequency ranges on both sides of the reference channel are displayed in the text window.

Key Path: **Trace/View**
Saved State: Saved in instrument state.
History: Added with ESA firmware revision A.07.00

Remote Command:

There is no remote command for this function.

2.22.3 Integrated Power

Press **Integrated Power** to view the measurement results of Spectrum (Ref: Total Pwr, Seg: Offset) measurements in the graph window as integrated absolute and relative peak power and frequency. The absolute and relative peak power levels integrated throughout the bandwidths between the start and stop frequencies and those corresponding offset frequency ranges on both sides of the reference channel are displayed in the text window.

Key Path: **Trace/View**

Saved State: Saved in instrument state.

History: Added with ESA firmware revision A.07.00

Remote Command:

There is no remote command for this function.

2.23 SPAN X Scale (Spectrum Emissions Mask—SEM)

Activates the Span function for the SEM measurement and displays the menu of span functions.

Key Path: Front-panel key
State Saved: Saved in Instrument State

Remote Command:

See the [Scale/Div](#), [Ref Value](#), and [Ref Position](#) commands below.

2.23.1 Scale/Div

Allows you to enter a numeric value to change the horizontal display sensitivity by setting the frequency units per horizontal graticule division. To determine full display frequency span, multiply the frequency span per horizontal graticule division by 10. This function is only available when you select **Spectrum Emissions Mask** from the Measurement menu.

Key Path: **MEASURE, Spectrum Emission Mask, SPAN X Scale**
State Saved: Saved in Instrument State
Factory Preset: 2.50000000 MHz
History: Added with PSA firmware revision A.02.00

2.23.2 Ref Value

Press **Ref Value** to set the frequency represented by the selected horizontal graticule line on the display (the reference). The current value is indicated by `ReF VaLue` in the upper left corner of the display. You can change the reference value using the step keys, the knob, or the numeric keypad. You can set the reference line location using the **Ref Position** setting. This function is only available when you select **Spectrum Emissions Mask** from the Measurement menu.

Key Path: **MEASURE, Spectrum Emission Mask, SPAN X Scale**
State Saved: Saved in Instrument State
Factory Preset: Center frequency value in Factory Preset state.
History: Added with PSA firmware revision A.02.00

2.23.3 Ref Position

Press **Ref Position** to position the X-Scale reference to the extreme left line, center line, or extreme right line of the display graticule.

Key Path: **MEASURE, Spectrum Emission Mask, SPAN X Scale**

Factory Preset: Center

2.24 Meas Setup (Spurious Emissions)

When the spurious emissions measurement has been selected in the Measure menu of the Spectrum Analysis mode, this key displays the appropriate measurement setup menu.

The spurious emissions measurement identifies and determines the power level of spurious emissions in certain frequency bands.

Key Path: Front-panel key
 History: Added with PSA firmware revision A.02.00
 Added with ESA firmware revision A.08.00

Remote Command:

There is no equivalent remote command.

2.24.1 Avg Number

Press **Avg Number** to **On** to specify the number of measurements that will be averaged when calculating the measurement result. The average will be displayed at the end of each sweep. **Off** disables the measurement averaging.

Key Path: **Meas Setup**
 State Saved: Saved in instrument state.
 Factory Preset: 10 averages / Off
 Range: 1 to 1000

Remote Command:

```
[ :SENSe ] : SPURious : AVERage : COUNT <integer>
[ :SENSe ] : SPURious : AVERage : COUNT ?
[ :SENSe ] : SPURious : AVERage [ :STATe ] OFF | ON | 0 | 1 turns the averaging on or off.
[ :SENSe ] : SPURious : AVERage [ :STATe ] ?
```

Example: SPUR:AVER:COUN 10
 SPUR:AVER OFF

2.24.2 Avg Mode

Selects the type of termination control used for the averaging function (Exp or Repeat). This determines the averaging action after the specified number of measurements (average count) is reached.

- **EXP** (Exponential Averaging mode)—When you set **Avg Mode** to **Exp**, each successive data acquisition after the average count is reached is exponentially weighted and combined with the existing average. Exponential averaging weights new data more than old data, which facilitates tracking of slow-changing signals. The average will be displayed at the end of each sweep.

One-Button Measurement Functions Meas Setup (Spurious Emissions)

- **Repeat**—When you set **Avg Mode** to **Repeat**, after reaching the average count, all previous result data is cleared and the average count is set back to 1.

Key Path: **Meas Setup**

State Saved: Saved in instrument state.

Factory Preset: EXPonential

Range: EXPonential|REPeat

Remote Command:

[:SENSe] :SPURious:AVERage:TCONrol EXPonential |REPeat

[:SENSe] :SPURious:AVERage:TCONrol?

Example: SPUR:AVG:TCON EXP
 SPUR:AVG:TCON?

2.24.3 Range Table

Enables you to enter the settings for up to 20 ranges, either using the instrument front panel keys or remotely. Upon entering the range table, the measurement stops, then the analyzer is set to a constantly sweeping idle state. The analyzer is then set to the current values for range 1 (whether range 1 is on or off). If a range is currently off, the values in the range table for that range are replaced with --- (see Range 5 in the illustration) to indicate this range is currently inactive.

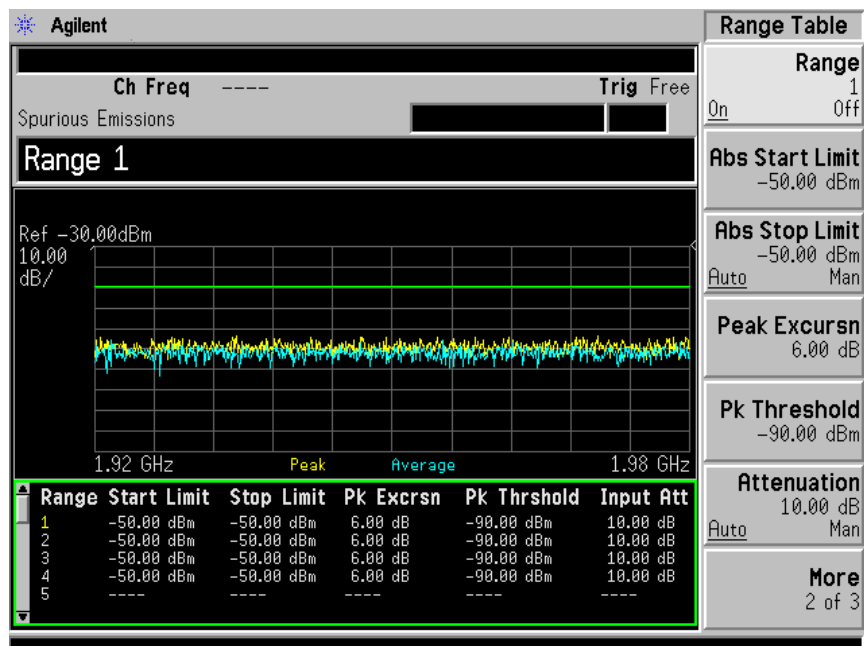

Key Path: **Meas Setup**

Saved State: All values for all ranges are saved in instrument state.

Factory Preset: For each range, the following settings are selected:

Video BW (Auto),
Sweep Time (Auto),

Absolute Limit = -50 dBm,
Peak Threshold = -90 dBm,
Peak Excursion = 6 dB, and
Abs Stop Limit Mode (Auto) is set to -50 dBm
Attenuation (Auto)
Detector 1 = Peak
Detector 2 = Off
Points = (Man) 601

The table below defines the other parameter's settings for the measurement. The values for ranges 1 through 5 are based on the W-CDMA (3GPP) BTS Spurious Emission measurement.

Table 2-5 Range Table Default Settings

Range	Start Freq (GHz)	Stop Freq (GHz)	Res BW (kHz)
1	1.920	1.980	1200
2	1.894	1.920	510
3	2.100	2.102	100
4	2.175	2.180	100
5	0.800	1.000	4000
6-20	1.5	2.5	Auto

Remote Command:

There is no equivalent remote command.

2.24.3.1 Range

Selects a range and updates the values on the other **Range Table** keys so that they reflect the settings for the selected range. If **Range** is set to **On** it is used as part of the measurement. When set to **Off** it is excluded.

Key Path: **Meas Setup, Range Table**

Factory Preset: See [“Range Table” on page 198](#).

Range: Off|On

Remote Command:

This parameter can receive up to 20 values. The location in the list sent corresponds to the range the value is associated with. Missing values are not permitted. For example, if you want to change values 2 and 6, you must send all values up to 6. Subsequent values remain as they were.

```
[ :SENSE ] :SPURious [ :RANGE ] [ :LIST ] :STATe OFF | ON | 0 | 1
```

The query for this parameter will always return 20 values.

```
[ :SENSE ] :SPURious [ :RANGE ] [ :LIST ] :STATe?
```

Example: SPUR:STAT OFF, ON, ON, OFF, ON, ON
 lists values 1 through 6

2.24.3.2 Start Freq

Used to set the start frequency of the analyzer.

Key Path:	Meas Setup, Range Table
Factory Preset:	See “Range Table” on page 198.
Knob Increment:	1%
Step Key Increment:	1, 1.5, 2, 3, 5, 7.5, 10, ...
Range:	Frequency range of your analyzer.

Remote Command:

This parameter can receive up to 20 values. The location in the list sent corresponds to the range the value is associated with. Missing values are not permitted, for example, if you want to change values 2 and 6, you must send all values up to 6. Subsequent values will remain as they were.

```
[ :SENSE ] :SPURious [ :RANGE ] [ :LIST ] :FREQuency:START <freq>, <freq>, ... (up to 20 frequencies)
```

The query for this parameter will always return 20 values.

```
[ :SENSE ] :SPURious [ :RANGE ] [ :LIST ] :FREQuency:START?
```

2.24.3.3 Stop Freq

Stop Freq is used to set the stop frequency of the analyzer.

Key Path:	Meas Setup, Range Table
Factory Preset:	See “Range Table” on page 198.
Knob Increment:	1%
Step Key Increment:	1, 1.5, 2, 3, 5, 7.5, 10, ...
Range:	Frequency range of your analyzer.

Remote Command:

This parameter can receive up to 20 values. The location in the list sent corresponds to the range the

value is associated with. Missing values are not permitted, for example, if you want to change values 2 and 6, you must send all values up to 6. Subsequent values will remain as they were.

```
[ :SENSe] :SPURious [ :RANGe] [ :LIST] :FREQuency:STOP <freq>, <freq>... (up to 20 frequencies)
```

The query for this parameter will always return 20 values.

```
[ :SENSe] :SPURious [ :RANGe] [ :LIST] :FREQuency:STOP?
```

2.24.3.4 Res BW

Res BW is used to set the resolution bandwidth of the analyzer. When **Auto** is selected the analyzer determines the optimum setting, while **Man** enables you to determine the setting.

Key Path:	Meas Setup, Range Table
Factory Preset:	See “Range Table” on page 198 .
Knob Increment:	Steps through the available resolution bandwidth filters.
Step Key Increment:	Steps through the available resolution bandwidth filters.
Range:	Resolution bandwidth range of your analyzer.

Remote Command:

This parameter can receive up to 20 values. The location in the list sent corresponds to the range the value is associated with. Missing values are not permitted, for example, if you want to change values 2 and 6, you must send all values up to 6. Subsequent values will remain as they were.

```
[ :SENSe] :SPURious [ :RANGe] [ :LIST] :BANDwidth [ :RESolution] :AUTO OFF|ON|0|1  
selects the mode.
```

```
[ :SENSe] :SPURious [ :RANGe] [ :LIST] :BANDwidth [ :RESolution] <freq>, <freq>, ...  
(up to 20 frequencies)
```

The query for this parameter always returns 20 values.

```
[ :SENSe] :SPURious [ :RANGe] [ :LIST] :BANDwidth [ :RESolution] :AUTO?
```

```
[ :SENSe] :SPURious [ :RANGe] [ :LIST] :BANDwidth [ :RESolution] ?
```

2.24.3.5 Video BW

Video BW is used to set the video bandwidth of the analyzer. When **Auto** is selected the analyzer determines the optimum setting, while **Man** enables you to determine the setting.

Key Path:	Meas Setup, Range Table
Factory Preset:	See “Range Table” on page 198 .
Knob Increment:	Steps through the available video bandwidth filters.
Step Key Increment:	Steps through the available video bandwidth filters.
Range:	Video bandwidth range of your analyzer.

Remote Command:

This parameter can receive up to 20 values. The location in the list sent corresponds to the range the value is associated with. Missing values are not permitted, for example, if you want to change values 2 and 6, you must send all values up to 6. Subsequent values will remain as they were.

```
[ :SENSe ] :SPURious [ :RANGe ] [ :LIST ] :BWIDth | BANDwidth :VIDeo :AUTO OFF | ON | 0 | 1
selects the mode.
```

```
[ :SENSe ] :SPURious [ :RANGe ] [ :LIST ] :BWIDth | BANDwidth :VIDeo <freq>, <freq>, ... (up to
20 frequencies)
```

The query for this parameter will always return 20 values.

```
[ :SENSe ] :SPURious [ :RANGe ] [ :LIST ] :BWIDth | BANDwidth :VIDeo :AUTO?
```

```
[ :SENSe ] :SPURious [ :RANGe ] [ :LIST ] :BWIDth | BANDwidth :VIDeo?
```

2.24.3.6 Sweep Time

Sweep Time is used to set the sweep time of the analyzer. When **Auto** is selected the analyzer determines the optimum setting, while **Man** enables you to determine the setting.

Key Path:	Meas Setup, Range Table
Factory Preset:	See “Range Table” on page 198 .
Knob Increment:	1%
Step Key Increment:	1, 1.5, 2, 3, 5, 7.5, 10, ...
Range:	Sweep time range of your analyzer.

Remote Command:

```
[ :SENSe ] :SPURious [ :RANGe ] [ :LIST ] :SWEep :TIME :AUTO OFF | ON | 0 | 1, OFF | ON | 0 | 1
```

```
[ :SENSe ] :SPURious [ :RANGe ] [ :LIST ] :SWEep :TIME :AUTO?
```

```
[ :SENSe ] :SPURious [ :RANGe ] [ :LIST ] :SWEep :TIME: <time>, <time>, ... (up to 20
sweeptimes)
```

```
[ :SENSe ] :SPURious [ :RANGe ] [ :LIST ] :SWEep :TIME?
```

Remote Command

Notes: This parameter can receive up to 20 values. The location in the list sent corresponds to the range the value is associated with. Missing values are not permitted, for example, if you want to change values 2 and 6, you must send all values up to 6. Subsequent values will remain as they were.

The query for this parameter will always return 20 values.

```
Example: [ :SENSe ] :SPURious [ :RANGe ] [ :LIST ] :SWEep :TIME :AUTO ON, OFF, ON
[ :SENSe ] :SPURious [ :RANGe ] [ :LIST ] :SWEep :TIME: 4ms, 10ms
```

2.24.3.7 Abs Start Limit

Abs Start Limit is used to set the absolute start limit to the set value, then sets the absolute stop limit to the same value as the start limit. Any spurs located above the current setting of **Peak Excursion** and

Threshold will be added to the results table. A red F will be appended to the amplitude value of the spur if the measured amplitude of the spur is above the limit set with **Abs Start Limit**.

Key Path:	Meas Setup, Range Table
Dependencies/ Couplings:	If the limit is set to Auto , Abs Start Limit and Abs Stop Limit are coupled to make a flat limit line. If set to Man , the absolute start and stop limits can take different values to make a sloped limit line.
Factory Preset:	See “Range Table” on page 198 .
Knob Increment:	0.1 dB
Step Key Increment:	1 dB
Range:	–150 dBm to 50 dBm
History:	Added with PSA firmware revision A.03.00 Added with ESA firmware revision A.09.00

Remote Command:

```
:CALCulate:SPURious[:RANGe][:LIST]:LIMit:ABSolute[:UPPER]:DATA:START
<integer>, <integer>, ...
:CALCulate:SPURious[:RANGe][:LIST]:LIMit:ABSolute[:UPPER]:DATA:START?
```

Remote Command

Notes: This parameter can receive up to 20 values. The location in the list sent corresponds to the range the value is associated with. Missing values are not permitted, for example, if you want to change values 2 and 6, you must send all values up to 6. Subsequent values will remain as they were.

The query for this parameter will always return 20 values.

Related commands are

```
[ :SENSe ] : SPURious [ :RANGe ] [ :LIST ] : SWEep : TIME : AUTO ?
```

```
[ :SENSe ] : SPURious [ :RANGe ] [ :LIST ] : SWEep : TIME ?
```

2.24.3.8 Abs Stop Limit

Abs Stop Limit is used to determine the limit above which spurs will report a failure. If any spurs are located above the current setting of **Peak Excursn** will be added to the results table. A red F will be appended to the amplitude value of the spur if the measured amplitude of the spur is above the limit set with **Abs Stop Limit**.

Key Path:	Meas Setup, Range Table
Dependencies/ Couplings:	If the limit is set to Auto , Abs Start Limit and Abs Stop Limit are coupled to make a flat limit line. If set to Man , the absolute start and stop limits can take different values to make a sloped limit line.

One-Button Measurement Functions Meas Setup (Spurious Emissions)

Factory Preset: See “Range Table” on page 198.

Knob Increment: 0.1 dB

Step Key Increment: 1 dB

Range: –150 dBm to 50 dBm

History: Added with PSA firmware revision A.03.00

Added with ESA firmware revision A.09.00

Remote Command:

```
:CALCulate:SPURious[:RANGE][:LIST]:LIMit:ABSolute[:UPPER]:DATA:STOP  
<integer>,<integer>,...
```

```
:CALCulate:SPURious[:RANGE][:LIST]:LIMit:ABSolute[:UPPER]:DATA:STOP?
```

```
:CALCulate:SPURious[:RANGE][:LIST]:LIMit:ABSolute[:UPPER]:DATA:STOP:AUTO  
OFF|ON|0|1, OFF|ON|0|1
```

```
:CALCulate:SPURious[:RANGE][:LIST]:LIMit:ABSolute[:UPPER]:DATA:STOP:AUTO?
```

Remote Command Notes: This parameter can receive up to 20 values. The location in the list sent corresponds to the range the value is associated with. Missing values are not permitted, for example, if you want to change values 2 and 6, you must send all values up to 6. Subsequent values will remain as they were.

The query for this command will always return 20 values.

Example: :CALC:SPUR:LIM:ABS:DATA -23,-27

:CALC:SPUR:LIM:ABS:DATA:AUTO ON, ON, ON, ON

2.24.3.9 Peak Excursn

Peak Excursn sets the minimum amplitude variation of signals that can be identified as peaks. For example, if a value of 6 dB is selected, peaks that rise and fall more than the 6 dB above the peak threshold value are identified.

Key Path: **Meas Setup, Range Table**

Factory Preset: See “Range Table” on page 198.

Knob Increment: 1 dB

Step Key Increment: 1 dB

Range: 0.0 dB to 100.0 dB

Remote Command:

This parameter can receive up to 20 values. The location in the list sent corresponds to the range the value is associated with. Missing values are not permitted, for example, if you want to change values 2 and 6, you must send all values up to 6. Subsequent values will remain as they were.

```
[ :SENSe ] :SPURious[:RANGE][:LIST]:PEAK:EXCURsion <integer>,<integer>,...
```

The query for this parameter will always return 20 values.

```
[ :SENSe ] : SPURious [ :RANGe ] [ :LIST ] : PEAK : EXCursion?
```

2.24.3.10 Pk Threshold

Pk Threshold sets the minimum amplitude of signals that can be identified as peaks. For example, if a value of -90 dBm is selected, only peaks that rise and fall more than the peak excursion value and are above the Pk Threshold of -90 dBm are identified.

Key Path:	Meas Setup, Range Table
Factory Preset:	See “Range Table” on page 198.
Knob Increment:	1 dB
Step Key Increment:	1 dB
Range:	-100 dB to 0.0 dB

Remote Command:

This parameter can receive up to 20 values. The location in the list sent corresponds to the range the value is associated with. Missing values are not permitted, for example, if you want to change values 2 and 6, you must send all values up to 6. Subsequent values will remain as they were.

```
[ :SENSe ] : SPURious [ :RANGe ] [ :LIST ] : PEAK : THReshold <integer>, <integer>,...
```

The query for this parameter will always return 20 values.

```
[ :SENSe ] : SPURious [ :RANGe ] [ :LIST ] : PEAK : THReshold?
```

2.24.3.11 Attenuation

PSA Only: **Attenuation** sets the attenuation for each range. This parameter can send up to 20 values. The location in the list sent corresponds to the range the value is associated with. Missing values are not permitted, for example, if you want to change values 2 and 6 you must send all values up to 6. Subsequent values will remain as they were.

Key Type:	Toggle
Key Path:	Meas Setup, Range Table
State Saved:	Saved in instrument state.
Factory Preset:	Auto, the value is determined by the radio standard and the instrument model.
Knob Increment:	2 dB
Step Key Increment:	2 dB
Range:	0 to 70 dB
History:	Added with PSA firmware revision A.06.00

Remote Command:

```
[ :SENSe ] : SPURious [ :RANGe ] [ :LIST ] : ATTenuation <integer>, <integer>,...
```

One-Button Measurement Functions Meas Setup (Spurious Emissions)

[:SENSE] :SPURious [:RANGe] [:LIST] :ATTenuation?

Remote Command Notes: The query always returns 20 values

Example: SPUR:RANG:LIST:ATT 20,20,20,20,20,20,20

2.24.3.12 Detector 1

PSA Only: Allows you to set the detector to be used by the trace which will be used for display purposes only.

The detector choices are:

- **Normal** – displays the peak of CW-like signals and maximums and minimums of noise-like signals.
- **Average** – displays the average of the signal within the sweep point (bucket). The averaging method depends upon **Avg Type** selection (voltage, power or log scales).
- **Peak** – displays the maximum of the signal within the sweep point (bucket).
- **Sample** – displays the instantaneous level of the signal at the center of the sweep point (bucket) represented by each display point.
- **Negative Peak** – displays the minimum of the signal within the sweep point (bucket).
- **Quasi Peak** – a fast-rise, slow-fall detector used in making CISPR compliant EMI measurements.
- **EMI Average** – displays the instantaneous level of the signal at the center of the sweep point (bucket), just like the sample detector. Also changes the auto coupling of VBW, RBW and Avg/VBW Type and the set of available RBWs. Used in making CISPR-compliant measurements.
- **EMI Peak** – the same as the Peak detector but uses CISPR related bandwidths.
- **MIL Peak** – the same as the Peak detector but uses MIL related bandwidths.

Key Path: **Meas Setup, Range Table**

State Saved: Saved in instrument state.

Factory Preset: Auto, the value is determined by the radio standard and the instrument model.

Knob Increment: 2 dB

Step Key Increment: 2 dB

Range: 0 to 70 dB

History: Added with PSA firmware revision A.06.00

Remote Command:

[:SENSE] :SPURious [:RANGe] [:LIST] :POINTs [:FUNCTION]

NORMAL | AVERAGE | POSITIVE | SAMPLE | NEGATIVE | QPEAK | EAVERAGE | EPOSITIVE | MPOSITIVE

[:SENSE] :SPURious [:RANGe] [:LIST] :DET?

Example: SPUR:POIN QPE

2.24.3.13 Detector 2

PSA Only: Allows you to set the detector to be used by the trace which will be used for display purposes only.

The detector choices are:

- **Off** – turns off second trace (Detector 2)
- **Normal** – displays the peak of CW-like signals and maximums and minimums of noise-like signals.
- **Average** – displays the average of the signal within the sweep point (bucket). The averaging method depends upon **Avg Type** selection (voltage, power or log scales).
- **Peak** – displays the maximum of the signal within the sweep point (bucket).
- **Sample** – displays the instantaneous level of the signal at the center of the sweep point (bucket) represented by each display point.
- **Negative Peak** – displays the minimum of the signal within the sweep point (bucket).
- **Quasi Peak** – a fast-rise, slow-fall detector used in making CISPR compliant EMI measurements.
- **EMI Average** – displays the instantaneous level of the signal at the center of the sweep point (bucket), just like the sample detector. Also changes the auto coupling of VBW, RBW and Avg/VBW Type and the set of available RBWs. Used in making CISPR-compliant measurements.
- **EMI Peak** – the same as the Peak detector but uses CISPR related bandwidths.
- **MIL Peak** – the same as the Peak detector but uses MIL related bandwidths.

Key Path: **Meas Setup, Range Table**

State Saved: Saved in instrument state.

Factory Preset: Auto, the value is determined by the radio standard and the instrument model.

Knob Increment: 2 dB

Step Key Increment: 2 dB

Range: 0 to 70 dB

History: Added with PSA firmware revision A.06.00

Remote Command:

```
[ :SENSE ] : SPURious [ :RANGE ] [ :LIST ] : POINTs [ :FUNCTION ]
OFF | NORMAl | AVERAge | POSitive | SAMPLe | NEGAtive | QPEak | EAVERage |
EPOSitive | MPositive
```

```
[ :SENSE ] : SPURious [ :RANGE ] [ :LIST ] : DET2?
```

Example: SPUR:DET2 EAV

2.24.3.13.1 Normal

PSA Only: Displays the peak-detected level in the interval (sweep points bucket) being displayed when the signal is CW-like. If the signal is noise-like (within an interval, sweep points bucket, the signal both rose and fell), the even sweep points bucket shows the peak (maximum) within a two-bucket interval,

One-Button Measurement Functions

Meas Setup (Spurious Emissions)

and the odd sweep points bucket shows the negative peak (minimum). Gain is increased to compensate for the effects of faster sweep rates, to keep the displayed value of CW signals accurate.

When **Normal** is selected, *Norm* appears on the left side of the display.

Key Path: **Meas Setup, Range Table, Detector 1 or Detector 2**

State Saved: Saved in instrument state.

History: Added with PSA firmware revision A.06.00

Remote Command:

See “[Detector 2](#)” on page 207.

2.24.3.13.2 Average

PSA Only: For each interval (sweep points bucket) in the trace, Average detection displays the average of all samples within the interval using one of the following averaging methods:

- log (also known as video)
- power (also known as RMS)
- voltage envelope

To explicitly set the averaging method, use the **BW/Avg, Avg/VBW Type** key. The combination of the average detector and the power method is equivalent to what is sometimes referred to as “RMS detection.” When the method (**Avg/VBW Type**) is set to **Pwr Avg**, and **Detector** is set to **Average**, the RMS method is selected.

When **Average** is selected, *Avg* appears on the left side of the display.

Key Path: **Meas Setup, Range Table, Detector 1 or Detector 2**

State Saved: Saved in instrument state.

History: Added with PSA firmware revision A.06.00

Remote Command:

See “[Detector 2](#)” on page 207.

2.24.3.13.3 Peak

PSA Only: For each interval (sweep points bucket) in the trace, Peak detection displays the highest amplitude within the interval. Peak detection is used for CW measurements and some pulsed-RF measurements. For swept analysis, peak detection basically obtains the maximum video signal between the end of the last sweep points bucket and the start of the next one. Gain is increased to compensate for the effects of faster sweep rates, to keep the displayed value accurate. For FFT analysis, the highest spectral amplitude is displayed, even if that peak amplitude falls between samples of the spectrum computed in the FFT process.

When **Peak** is selected, *Peak* appears on the left side of the display.

Key Path: **Meas Setup, Range Table, Detector 1 or Detector 2**

State Saved: Saved in instrument state.

History: Added with PSA firmware revision A.06.00

Remote Command:

See “[Detector 2](#)” on page 207.

2.24.3.13.4 Sample

PSA Only: The sample detector displays the instantaneous level of the signal at the center of the interval (sweep points bucket) represented by each trace point.

Sample detection is primarily used to display noise or noise-like signals.

Sample detection is not best for amplitude measurements of CW-like signals for two reasons. First, the peak response to a signal can occur between samples, so unless the Span to RBW ratio is lower than usual, the highest sample can be well below the peak signal amplitude. Second, for the high sweep rates normally used, the peak response of the RBW filters is up to -0.5 dB. This sweeping error is compensated when using the peak and normal detectors by changing the overall gain. But the gain is not changed when in the sample detector, because to do so would cause errors in the response to noise.

When **Sample** is selected, `Samp` appears on the left side of the display.

Key Path: **Meas Setup, Range Table, Detector 1 or Detector 2**

State Saved: Saved in instrument state.

History: Added with PSA firmware revision A.06.00

Remote Command:

See “[Detector 2](#)” on page 207.

2.24.3.13.5 Negative Peak

PSA Only: For each interval (sweep points bucket) in the trace, **Negative Peak** detection displays the lowest sample within the interval.

When **Negative Peak** is selected, `NPk` appears on the left side of the display.

Key Path: **Meas Setup, Range Table, Detector 1 or Detector 2**

State Saved: Saved in instrument state.

History: Added with PSA firmware revision A.06.00

Remote Command:

See “[Detector 2](#)” on page 207.

2.24.3.13.6 Quasi Peak

PSA Only: Selects quasi peak detection. This is a fast-rise, slow-fall detector used in making CISPR compliant EMI measurements. Quasi peak detection displays a weighted amplitude using specific charge, discharge, and meter-movement time constants as described in CISPR Publication 16.

Key Path: **Meas Setup, Range Table, Detector 1 or Detector 2**

State Saved: Saved in instrument state.

One-Button Measurement Functions Meas Setup (Spurious Emissions)

History: Added with PSA firmware revision A.06.00

Remote Command:

See [“Detector 2” on page 207](#).

2.24.3.13.7 EMI Average

PSA Only: Selects EMI averaging detection. EMI Average detection displays the average value of amplitude envelope. It is defined for EMI measurements by the CISPR standard and uses the VBW filter as a low pass filter, the output of which is sampled during the bucket interval. This functionality is quite different from the Average detector.

Key Path: **Meas Setup, Range Table, Detector 1 or Detector 2**

State Saved: Saved in instrument state.

History: Added with PSA firmware revision A.06.00

Remote Command:

See [“Detector 2” on page 207](#).

2.24.3.13.8 EMI Peak

PSA Only: Selects peak detection using EMI specifications.

Key Path: **Meas Setup, Range Table, Detector 1 or Detector 2**

State Saved: Saved in instrument state.

History: Added with PSA firmware revision A.06.00

Remote Command:

See [“Detector 2” on page 207](#).

2.24.3.13.9 MIL Peak

PSA Only: Selects peak detection using the MIL specifications.

Key Path: **Meas Setup, Range Table, Detector 1 or Detector 2**

State Saved: Saved in instrument state.

History: Added with PSA firmware revision A.06.00

Remote Command:

See [“Detector 2” on page 207](#).

2.24.3.13.10 Off

PSA Only: Detector 2 is off, there is no second trace.

Key Path: **Meas Setup, Range Table, Detector 2**

State Saved: Saved in instrument state.
 History: Added with PSA firmware revision A.06.00

Remote Command:

See “Detector 2” on page 207.

2.24.3.14 Points

PSA Only: Used to set the points mode of the analyzer. Setting to **Man** allows you to determine the setting, or by selecting **Auto** the analyzer will determine the number of trace points to ensure the sweep point (bucket) resolution equals RBW/2.

Key Path: **Meas Setup, Range Table**

State Saved: Saved in instrument state.

Factory Preset: Auto, the value is determined by the radio standard and the instrument model.

Knob Increment: 1

Step Key Increment: 1

Range: 101 to 8192

History: Added with PSA firmware revision A.06.00

Remote Command:

```
[ :SENSe] :SPURious [ :RANGE] [ :LIST] :SWEep:POINts <integer>, <integer>,...
[ :SENSe] :SPURious [ :RANGE] [ :LIST] :SWEep:POINts?
[ :SENSe] :SPURious [ :RANGE] [ :LIST] :SWEep:POINts:AUTO
[ :SENSe] :SPURious [ :RANGE] [ :LIST] :SWEep:POINts:AUTO?
```

2.24.4 Meas Type

Specifies the measurement type (**Examine** or **Full**). This parameter is coupled to the average mode. If you select **Examine**, the measurement sets **Avg Mode** to **Exp**. If you select **Full**, the measurement sets **Avg Mode** to **Rep**. The behavior of each measurement type is described below.

	Single		Continuous	
	No Spurs	Spurs	No Spurs	Spurs
Examine	All active ranges are measured. Upon completion, the measurement is set to the idle state.	All active ranges are measured and the found spurs are reported. Upon completion, the measurement is set to the idle state.	All active ranges are measured. Upon completion, the analyzer remains set to the last range checked with an active trace.	All active ranges are measured and the found spurs are reported. Upon completion the analyzer is set to the range containing the worst spur found and continually sweeps this range.

One-Button Measurement Functions Meas Setup (Spurious Emissions)

	Single		Continuous	
	No Spurs	Spurs	No Spurs	Spurs
	The message <code>No Spurs</code> is displayed.	The trace containing the worst spur is restored. Spur is enabled (no longer grayed out). A marker is added, set to the frequency of the worst spur.	The message <code>No Spurs</code> is displayed.	Spur is enabled (no longer grayed out). A marker added, set to the frequency of the worst spur.
Full	All active ranges are measured. Upon completion, the measurement is set to the idle state. The message <code>No Spurs</code> is displayed.	All active ranges are measured and the found spurs are reported. Upon completion, the measurement is set to the idle state. The trace of the last active range is displayed.	Measurement continually cycles through all active ranges.	All active ranges are measured and the found spurs are reported. On each cycle of the active ranges, the report on spurs found is reset. This ensures that remote queries retrieve the trace data that matches the currently displayed results.

Key Path: **Meas Setup**

State Saved: Saved in instrument state.

Factory Preset: Examine

Range: Examine|Full

Remote Command:

```
[ :SENSE ] :SPURious:TYPE EXAMine|FULL
```

```
[ :SENSe ] :SPURious:TYPE?
```

Remote Command Notes n/a

Example: SPUR:TYPE FULL

2.24.5 Spur

Enables you to view any spurs that have been found. The measurement sets the analyzer to the range in which the currently selected spur was found. The range settings changes only if the selected spur is in the range that is different from the current range settings. A marker identifies the currently selected spur on the trace.

NOTE This key is enabled only when **Meas Type** is set to **Examine**, and only upon completion of a measurement.

Key Path: **Meas Setup**

Saved State: No values are saved to state.

Factory Preset: 1

Knob Increment: 1

Step Key Increment: 1

Range: 1 to 200, 10 per range

Remote Command:

`[:SENSe] : SPURious : SPUR <integer>`

`[:SENSe] : SPURious : SPUR?`

2.24.6 Ref Level

Pressing **Ref Level** sets the reference level of the analyzer.

Key Path: **Meas Setup**

Saved State: Ref Level state is saved to instrument state. Ref Level value is recalculated for each active range the value is not stored in instrument state.

Factory Preset: 0.00 dBm

Knob Increment: 1

Step Key Increment: 10

Range: -180 dBm to 20 dBm, without reference level offset

Remote Command:

`[:SENSe] : SPURious : POWer [:RF] : LEVel <integer>`

`[:SENSe] : SPURious : POWer [:RF] : LEVel?`

`[:SENSe] : SPURious : POWer [:RF] : RANGe : AUTO OFF | ON | 0 | 1`

`[:SENSe] : SPURious : POWer [:RF] : RANGe : AUTO?`

Example: `SPUR:POW:RF:LEV 10`

`SPUR:POW:RF:RANG:AUTO ON`

2.24.7 Fast Spurious Meas

Pressing **Fast Spurious Meas** turns the fast spurious measurement test on or off. Pressing **Fast Spurious Meas** to **On** provides a faster method of execution as with fast spurious testing spurs above the limit line are reported. Any spurs reported outside the limit will cause the measurement to fail. See [“Abs Start Limit” on page 202](#) for more information.

Key Path: **Meas Setup**

Saved State: Ref Level state is saved to instrument state. Ref Level value is recalculated for each active range the value is not stored in instrument state.

One-Button Measurement Functions Meas Setup (Spurious Emissions)

Factory Preset: Off
Range: Off|On
History: Add with PSA firmware revision A.03.00

Remote Command:

```
[ :SENSe ] :SPURious:FSMeas OFF|ON|0|1
```

```
[ :SENSe ] :SPURious:FSMeas?
```

Example: SPUR:FSM ON

2.25 Display (Spurious Emissions) for PSA Only

Displays menu keys that enable you to configure parameters for the spurious emissions measurement.

NOTE The keys described below are measurement dependent. To access the display menus, for the spurious emissions measurement press **MEASURE, Spurious Emissions**, then **Display**.

2.25.1 Full Screen

Expands the measurement window horizontally over the entire instrument display. Pressing any other key that results in a new menu cancels the full screen function.

Key Path: **Display**
State Saved: Not saved in state.
Factory Preset: Off
Factory Default: Off
History: Added with PSA firmware revision A.06.00

2.25.2 Preferences

Displays menu keys that enable you to turn the graticule and annotation on or off.

Key Path: **Display**
State Saved: Saved in instrument state.
History: Added with PSA firmware revision A.06.00

2.25.2.1 Graticule (On Off)

Pressing Graticule turns the display graticules **On** or **Off**.

Key Path: **Display, Preferences**
Factory Preset: On
Factory Default: On
Terminators: **Enter**
History: Added with PSA firmware revision A.06.00

2.25.2.2 Annotation (On Off)

Turns the screen annotation on or off, however, the menu key annotation will remain on the display. The screen annotation may not be required for prints or during remote operation.

Key Path: **Display**

Factory Preset
and *RST: On

Factory
Default: On

Terminators: Enter

History: Added with PSA firmware revision A.06.00

2.26 Marker (Spurious Emissions) for PSA Only

Displays the Marker control menu for the spurious emissions measurement. If no markers are active, **Marker** selects marker 1, sets it to **Normal** and places it to the right of the display. There are two control modes for the markers:

- **Normal (POSITION)** - A single marker that can be moved to any point on the trace.
- **Delta (DELTA)** - Places the selected marker and the next marker at the position of the previous marker on the specified trace (selected by pressing **Marker Trace**). The next marker is the reference marker (set to normal) and the selected marker is a moveable marker (delta) that you can place at any point on the trace. The difference between the selected marker and the reference marker is displayed.
- **Off (OFF)** - Turns off the active marker or marker pair.

Key Path: Front-panel key

State Saved: The control mode for each marker, as well as the position of each marker, is saved in instrument state.

Factory Preset: All Off.

History: Added with PSA firmware revision A.06.00

Remote Command:

There is no equivalent remote command.

2.26.1 Select Marker

Selects one of the four possible markers. Once a marker is selected, it can be set to any of the control modes Normal or Off.

Key Path: **Marker**

State Saved: The number of the selected marker is saved in instrument state.

Factory Preset: Marker 1

History: Added with PSA firmware revision A.06.00

Remote Command:

```
:CALCulate:SPURious:MARKer[1] | 2 | 3 | 4:STATE OFF|ON|0|1
```

```
:CALCulate:SPURious:MARKer[1] | 2 | 3 | 4:STATE?
```

One-Button Measurement Functions

Marker (Spurious Emissions) for PSA Only

Remote Command

Notes: Sets or queries the state of a marker. Setting a marker to state ON or 1 selects that marker. Setting a marker which is OFF to state ON or 1 puts it in **Normal** mode and places it on the screen to the right of the displayed measurement graph. Setting a marker to state OFF or 0 selects that marker and turns it off. The response to the query will be 0 if OFF, 1 if ON.

Example: `CALC:SPUR:MARK2:STAT ON` selects marker 2.
`CALC:SPUR:MARK:STAT ON` will not modify a marker that is already on.

2.26.2 Normal

Sets the control mode for the selected marker to **Normal** (see “[Select Marker](#)” on page 217). If the marker is off, a single marker is activated and placed on the screen to the right of the measurement graph. You can then adjust the trace point of the marker using the knob, numeric keypad, or \uparrow \downarrow keys.

Key Path: **Marker**
Factory Preset: Off
History: Added with PSA firmware revision A.06.00

Remote Command:

See “[Marker \(Spurious Emissions\) for PSA Only](#)” on page 217 for the mode command.

Example: `CALC:SPUR:MARK:STAT ON` selects marker 1 and sets it to **Normal**.

2.26.3 Delta

Sets the control mode for the selected marker to **Delta**. In **Delta** mode the display shows the difference between the active (**Delta**) marker and a reference marker. Annotation in the active function block and in the upper-right corner of the display indicates the power ratio (dB) difference and probability (percentage) difference of the two markers.

Key Path: **Marker** (after **MEASURE, Spurious Emissions** is selected.)
History: Added with PSA firmware revision A.08.00

Remote Command:

See Volume 1, *Core Spectrum Analyzer Functions User's and Programmer's Reference* guide.

Example: `CALC:SPUR:MARK3:MODE DELT` selects marker 3 as a delta marker and places a reference marker at the 0 dB point on the specified trace (see “[Marker Trace](#)” on page 118). If marker 3 is OFF it places both the active and the reference markers at the 0 dB point of the specified trace.

2.26.4 Off

Turns off the selected marker. In addition, **Off** also turns off functions related to the selected marker.

Key Path: **Marker**

Factory Preset: Off

History: Added with PSA firmware revision A.06.00

Remote Command:

See “[Select Marker](#)” on page 217 for the command to select the control mode.

Example: `CALC:SPUR:MARK3:STAT OFF` selects marker 3 and sets it to **Off**.

2.26.5 Markers All Off

Turns off all markers.

NOTE Selecting any measurement (including **Meas Off**) under the Measure menu, turns off the marker table.

Key Path: **Marker** (after **MEASURE, Power Stat CCDF** is selected.)

History: Added with PSA firmware revision A.06.00

Remote Command:

`:CALCulate:SPURious:MARKer[1]|2|3|4:AOFF`

Example: `CALC:SPUR:MARK:AOFF` turns off all markers.

2.26.6 Marker Mode

Sets the mode for the specified marker. When a marker is set to Delta, the next marker is used as the Reference Marker and its mode is set to Normal. The value of the delta marker is the relative value from the reference marker. When Marker4 is set to Delta, Marker1 is used as the Reference Marker.

NOTE Selecting any measurement (including **Meas Off**) under the Measure menu, turns off the marker table.

Key Path: **Marker** (after **MEASURE, Power Stat CCDF** is selected.)

History: Added with PSA firmware revision A.06.00

Remote Command:

`:CALCulate:SPURious:MARKer[1]|2|3|4:AOFF`

Example: `CALC:SPUR:MARK:AOFF` turns off all markers.

3 **Menu Maps: One-Button Measurement Functions**

This chapter provides you with menu maps for all measurements available to you when you press the front-panel **MEASURE** Key.

One-Button Measurement Menu Maps

This section provides a visual representation of all front-panel key menus associated with the measurements available when you press the front-panel **MEASURE** key. The key menus common to all measurements (**MEASURE**, **Meas Control**, and **Mode Setup**) are presented first. Then, the key menus unique to each measurement are displayed. Use the following table to locate the menus you wish to view and [Table on page 30](#) to locate the key descriptions and programming commands for these measurements.





Menu Map	Location	Menu Map	Location
MEASURE	Page 224	Multi-Carrier Power Menus	
Meas Control	Page 225	Meas Setup	Page 244
Mode Setup	Page 226	Trace/View	Page 245
ACP Menus		Occupied BW Menus	
Meas Setup	Page 230	Meas Setup	Page 246
Trace/View	Page 231	Spectrum Emission Mask Menus	
Burst Power Menus		Display	Page 248
Meas Setup	Page 232	Marker	Page 249
Trace/View	Page 233	Meas Setup	Page 247
CCDF Menus (Power Stat)		Span X Scale	Page 250
Display	Page 235	Trace/View	Page 251
Marker	Page 236	Spurious Emissions Menus	
Meas Setup	Page 234	Meas Setup	Page 252
Span X Scale	Page 237	Display	Page 254
Trace/View	Page 238	Marker	Page 255
Channel Power Menus			
Meas Setup	Page 239		
Trace/View	Page 240		
Harmonic Distortion Menus			
Meas Setup	Page 241		
Trace/View	Page 242		
Intermod (TOI) Menus			
Meas Setup	Page 243		

Directions for Use

Refer to the following notes to utilize the key-flow diagrams:

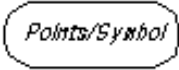
- Start from the upper left corner of each measurement diagram. Go to the right, and go from the top to the bottom.
- When changing a key from auto (with underline) to manual, just press that key one time.
- When entering a numeric value for **frequency**, a value with units, use the numeric keypad and terminate the entry with the appropriate unit selection from the softkeys displayed.
- When entering a numeric value for a unitless value, like **Avg Number**, use the numeric keypad and terminate the entry with the **Enter** front-panel key.
- Instead of using the numeric keypad to enter a value, it may be easier to use the front-panel knob or **Up/Down** arrow keys.

Table 3-1 **Menu Map Legend**

Icon	Description
	This represents the analyzer front-panel key.
	An oval represents additional levels of menus.
	This box shows how the softkey default condition is displayed. Default parameters or values are underlined wherever possible.
	A dagger to the left of a softkey indicates that when the key is pressed this is an active function.
	A double-dagger to the left of the softkey indicates a function that is not always available. It is dependent on other instrument settings.
	A bar on the left of two or more softkeys indicates that the keys are a mutually exclusive choice.

MEASURE Key

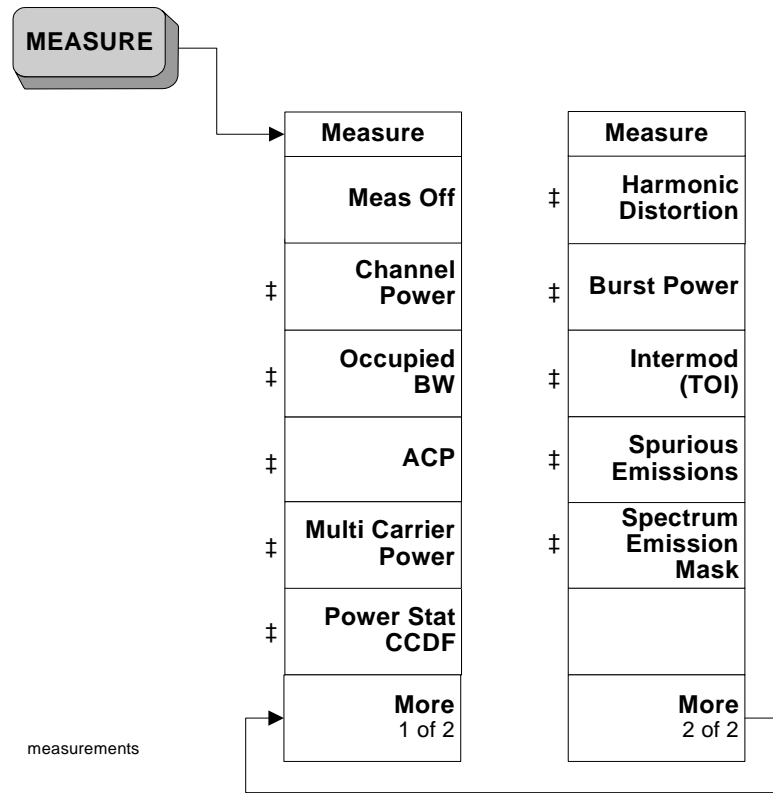

Menu Maps: One-Button Measurement Functions
 One-Button Measurement Menu Maps

Meas Control Key

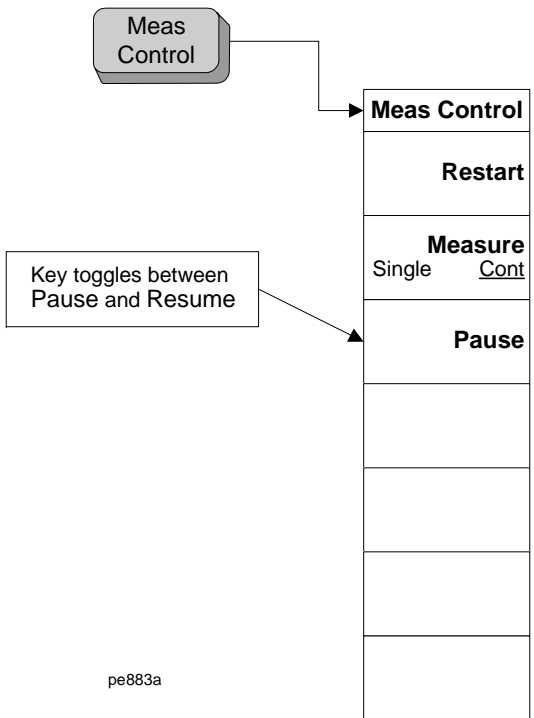

Mode Setup Key for ESA

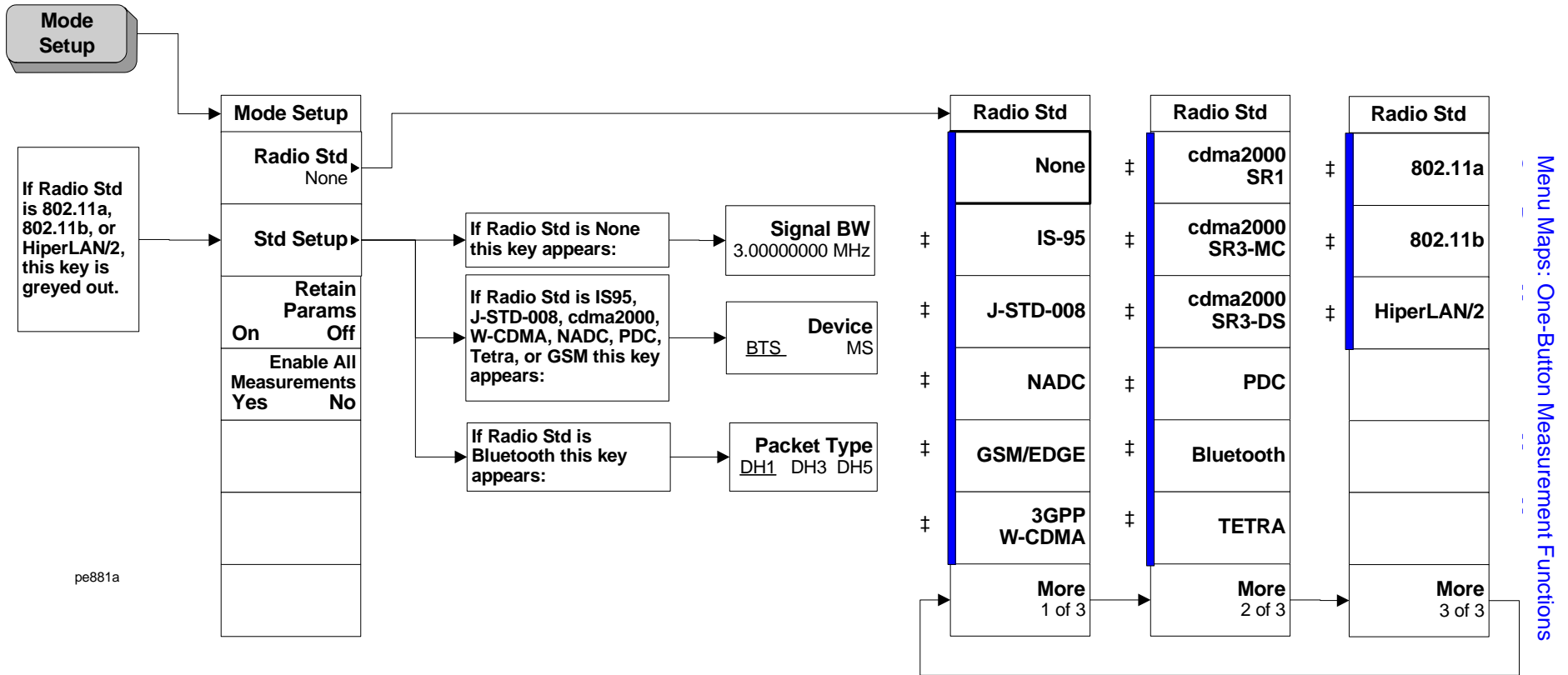

Mode Setup Key for PSA (1 of 3)

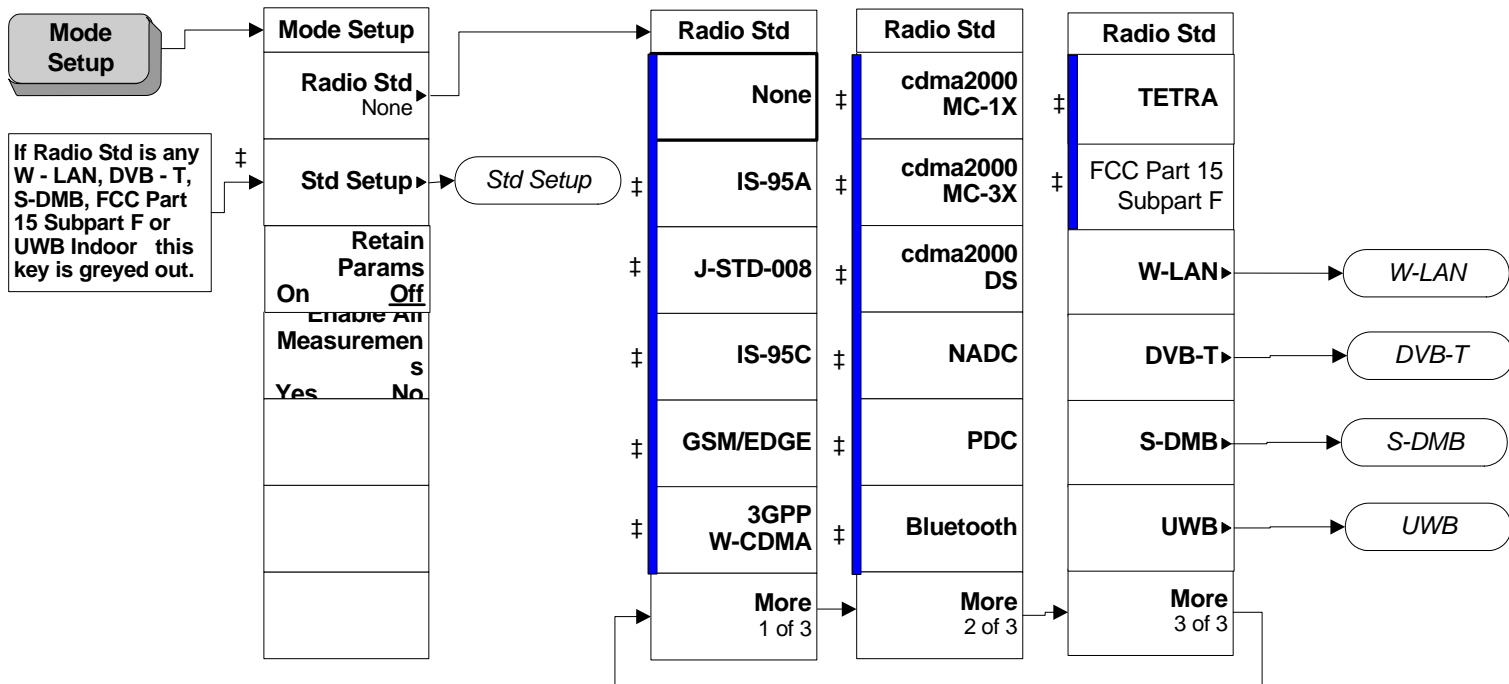

mode setup

Mode Setup Key for PSA (2 of 3)

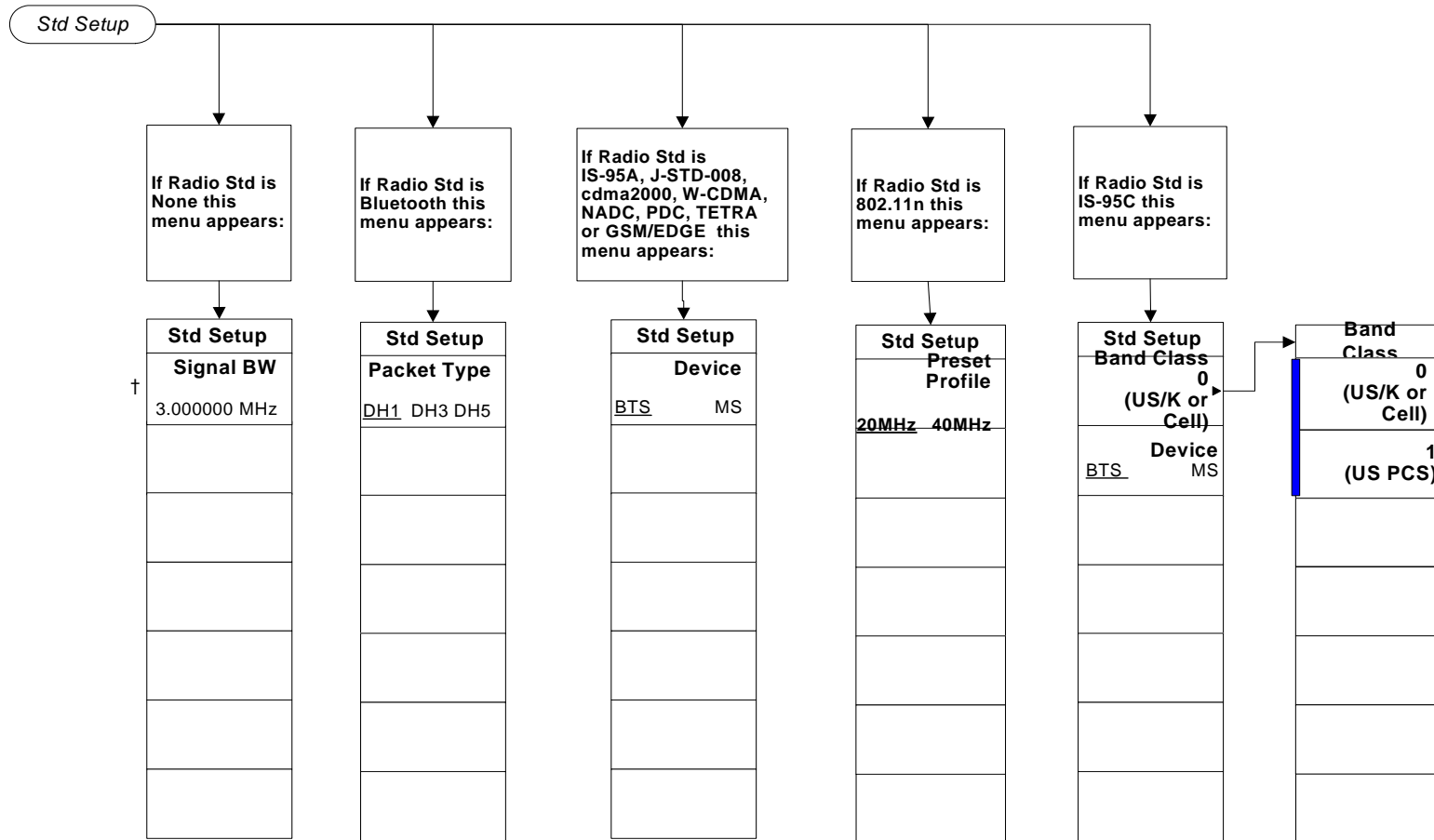

mode setup (2)

Menu Maps: One-Button Measurement Functions
One-Button Measurement Menu Maps

Mode Setup Key for PSA (3 of 3)

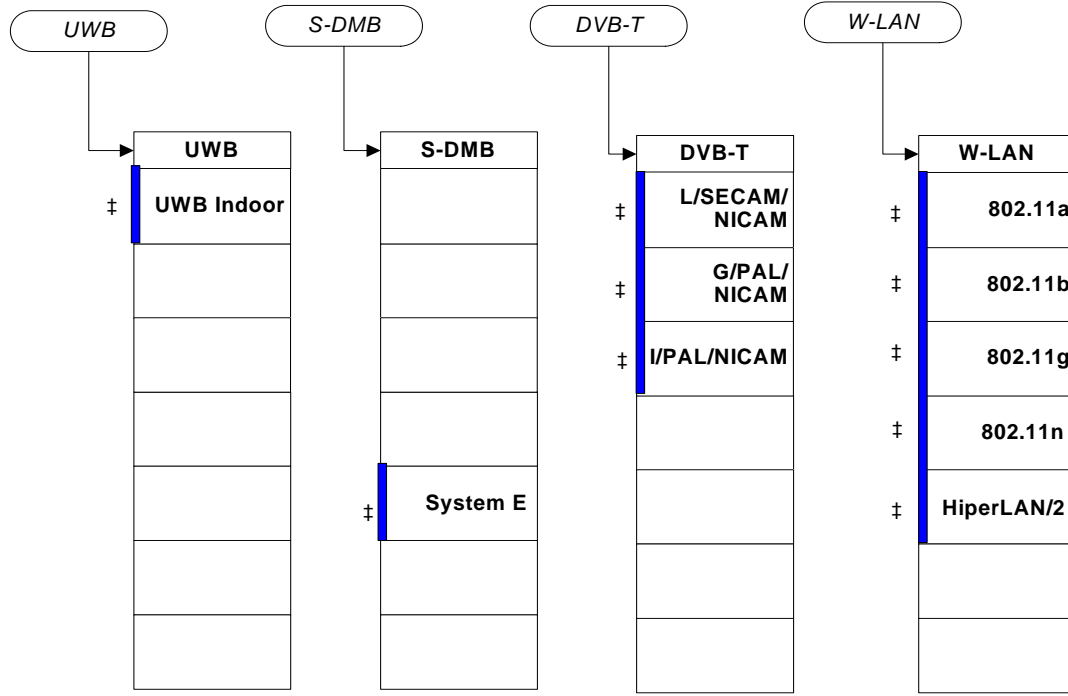

mode setup (3)

ACP Measurement: Meas Setup Key

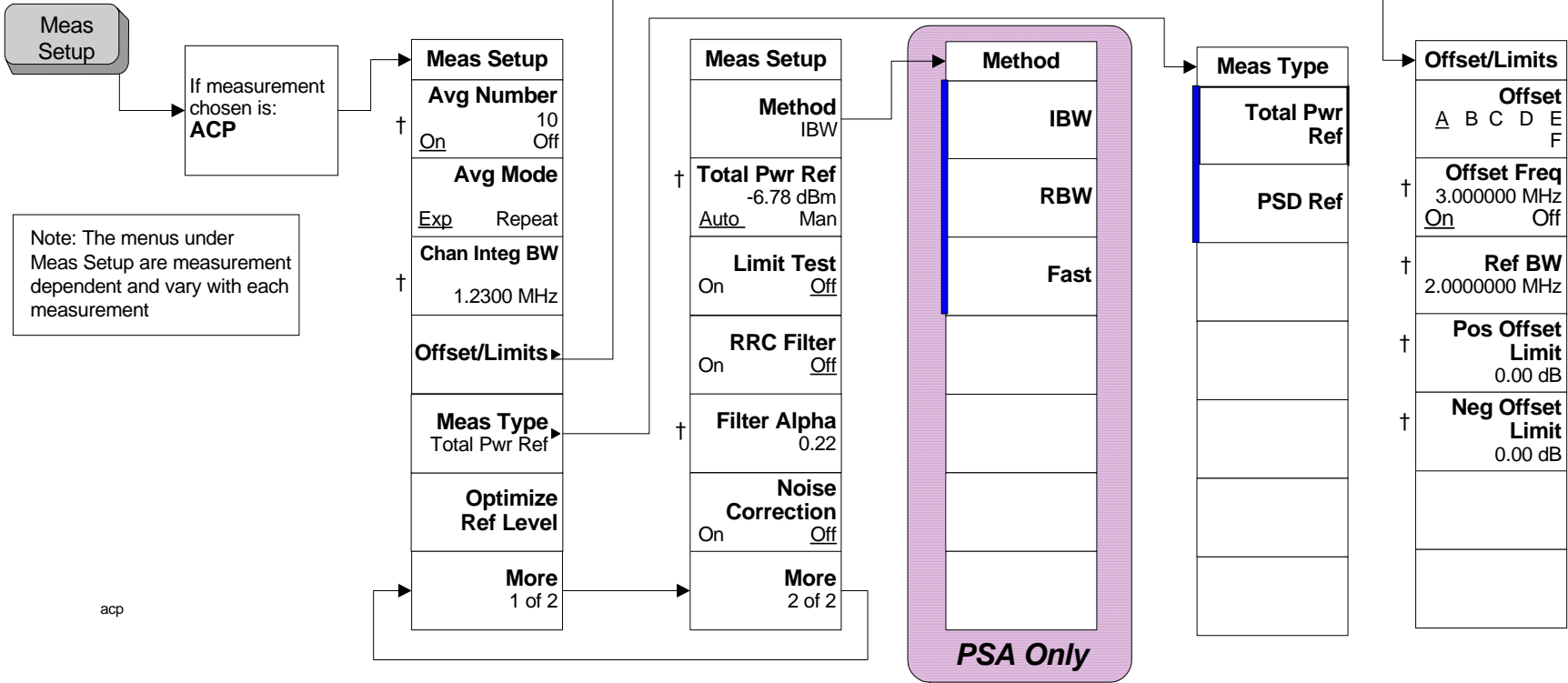

ACP Measurement: Trace/View Key

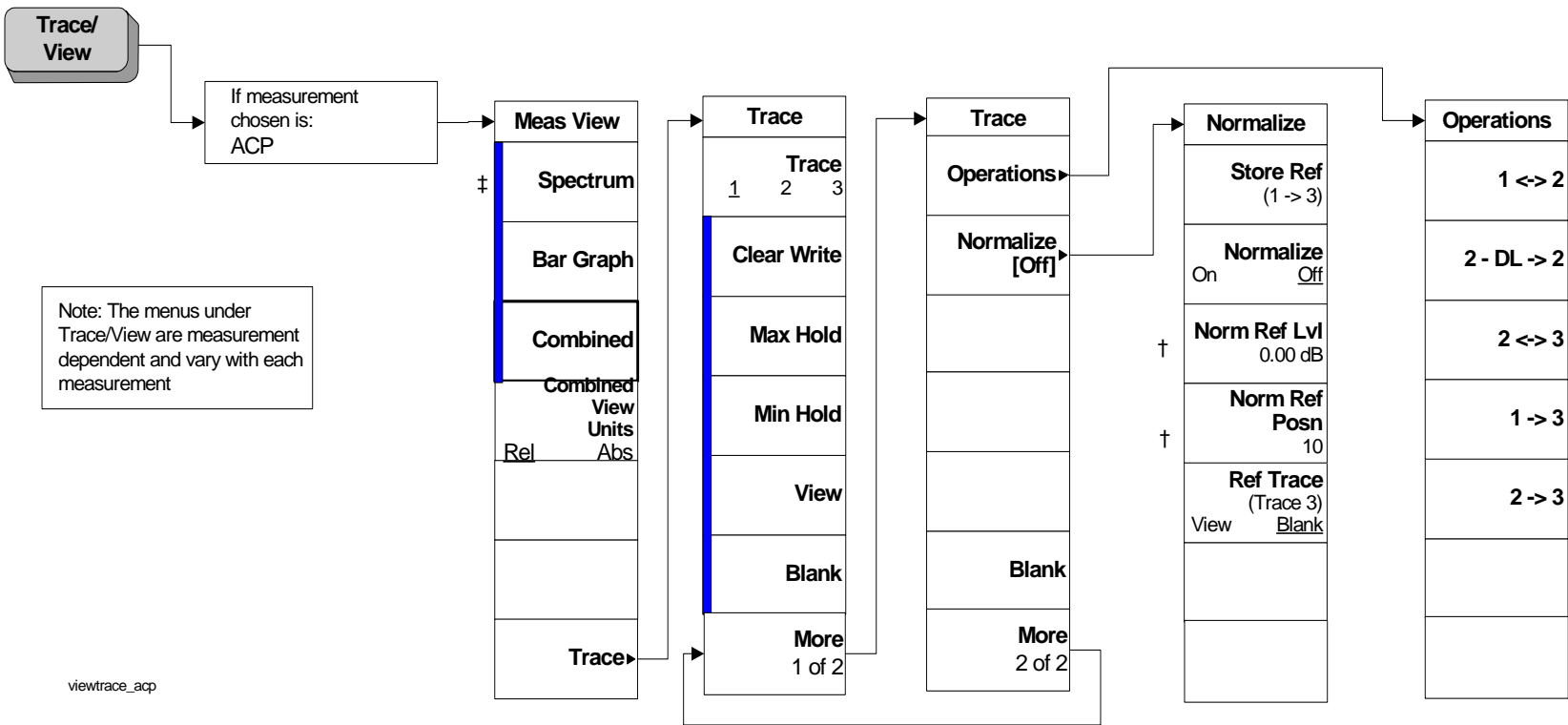

Burst Power Measurement: Meas Setup Key

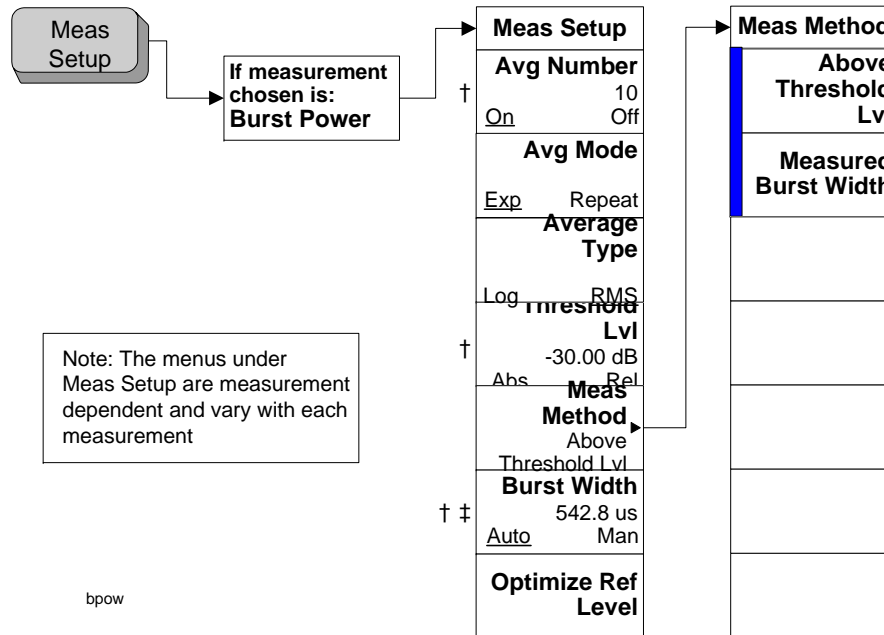

Note: The menus under Meas Setup are measurement dependent and vary with each measurement

bpow

Burst Power Measurement: Trace/View Key

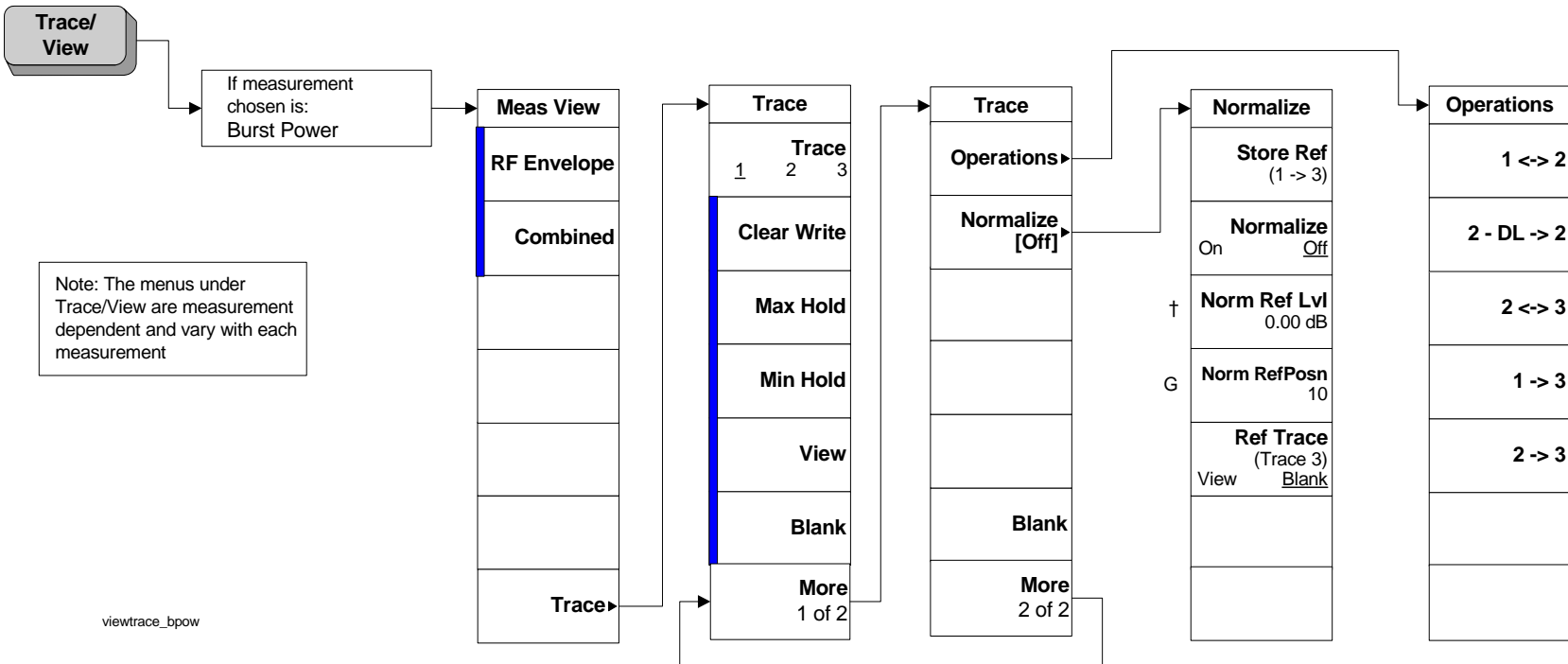

Note: The menus under Trace/View are measurement dependent and vary with each measurement

viewtrace_bpow

CCDF (Power Stat) Measurement: Meas Setup Key

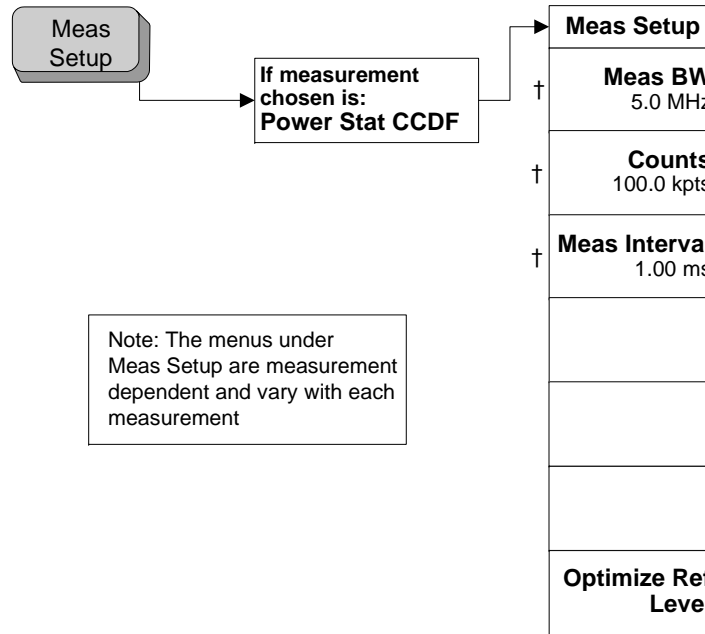

Note: The menus under Meas Setup are measurement dependent and vary with each measurement

ccdf

CCDF (Power Stat) Measurement: Display Key

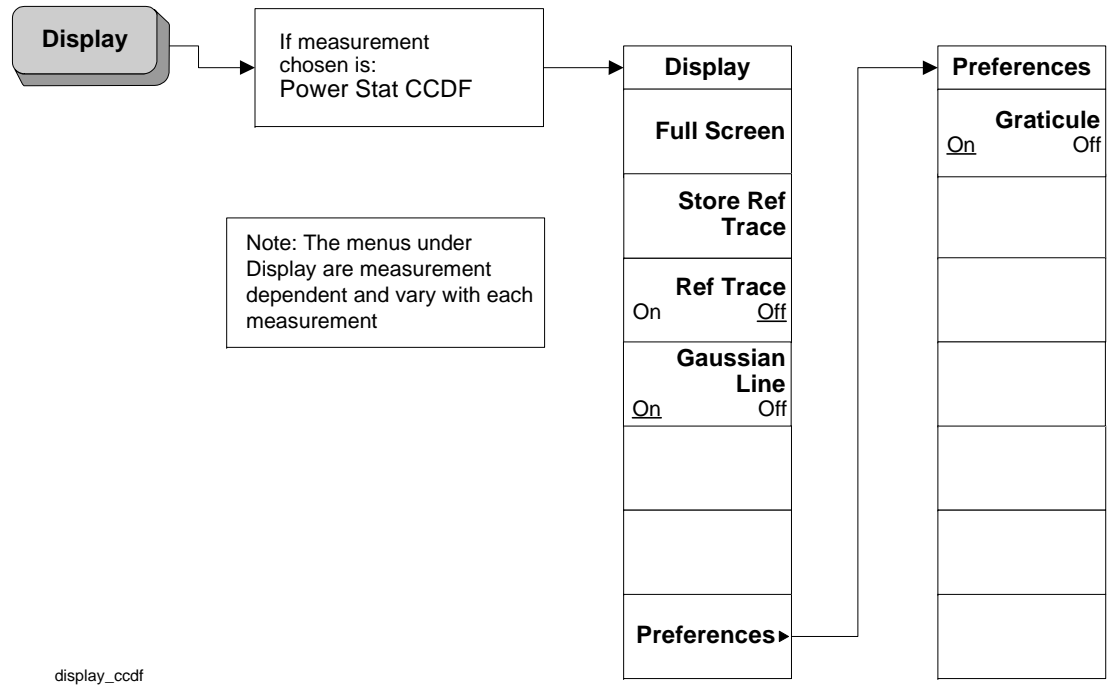

CCDF (Power Stat) Measurement: Marker Key

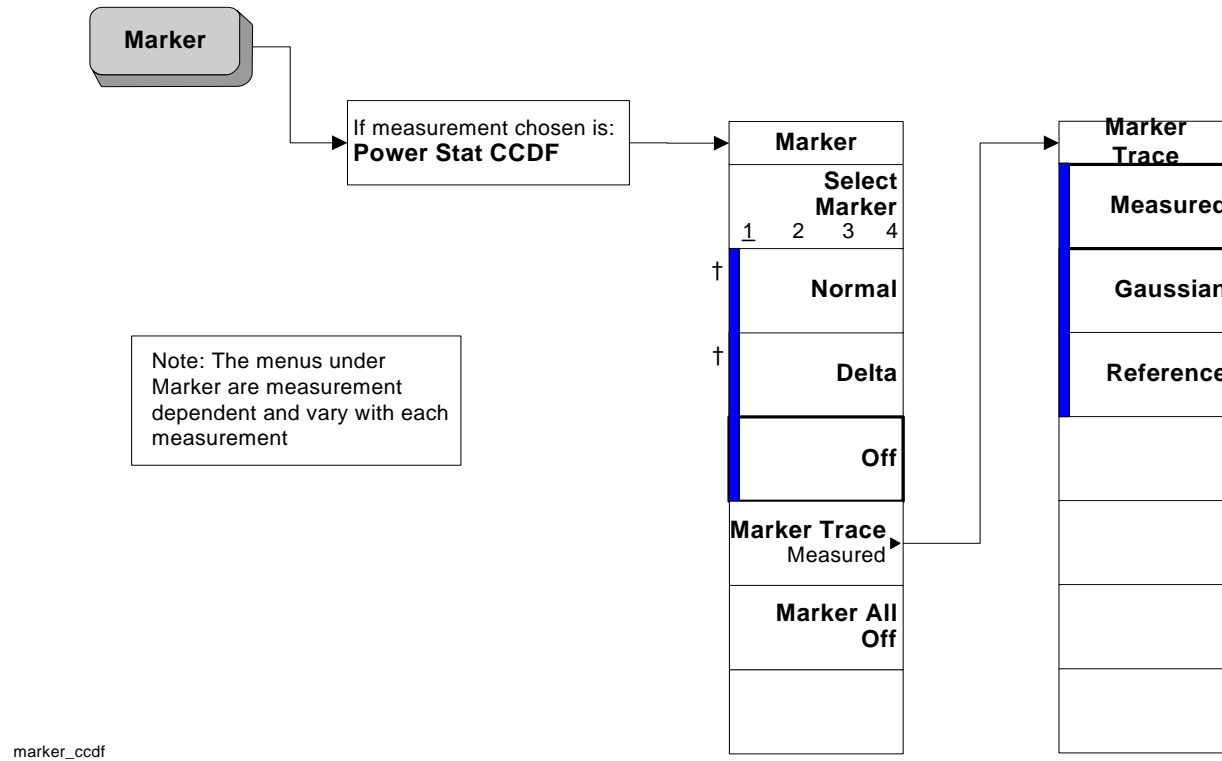

Note: The menus under Marker are measurement dependent and vary with each measurement

CCDF (Power Stat) Measurement: Span X Scale Key

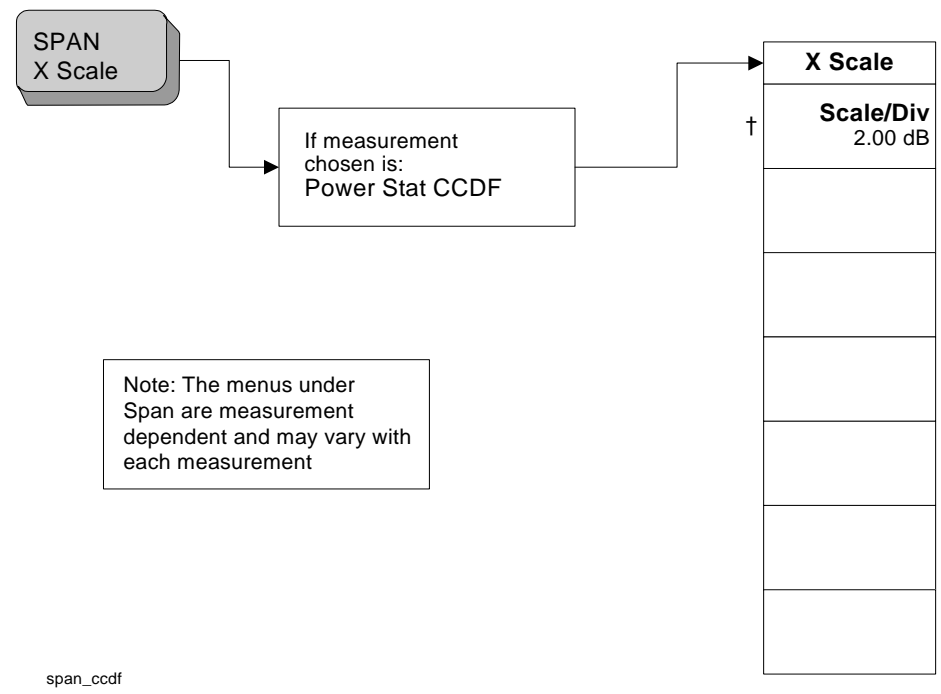

Note: The menus under Span are measurement dependent and may vary with each measurement

span_ccdf

CCDF (Power Stat) Measurement: Trace/View Key

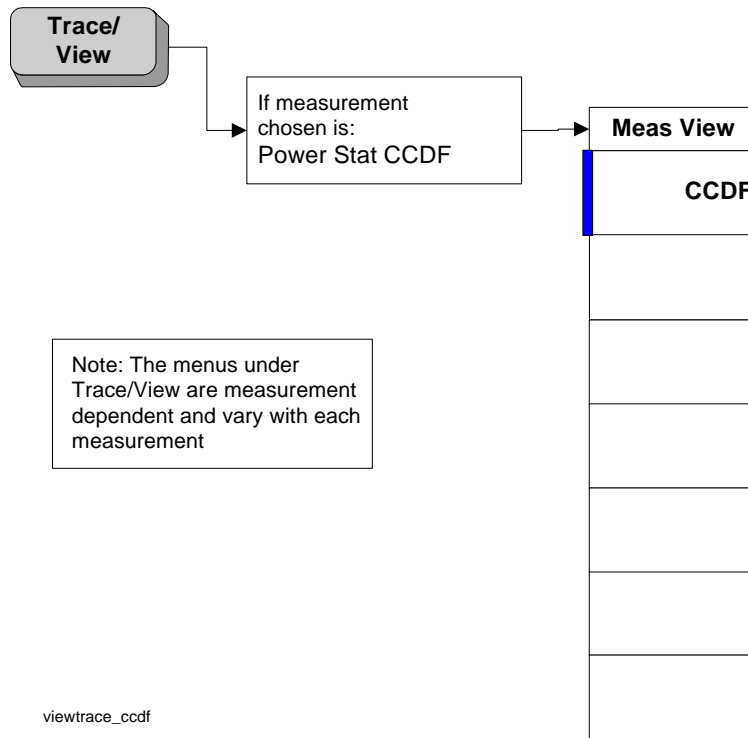

Note: The menus under Trace/View are measurement dependent and vary with each measurement

Channel Power Measurement: Meas Setup Key

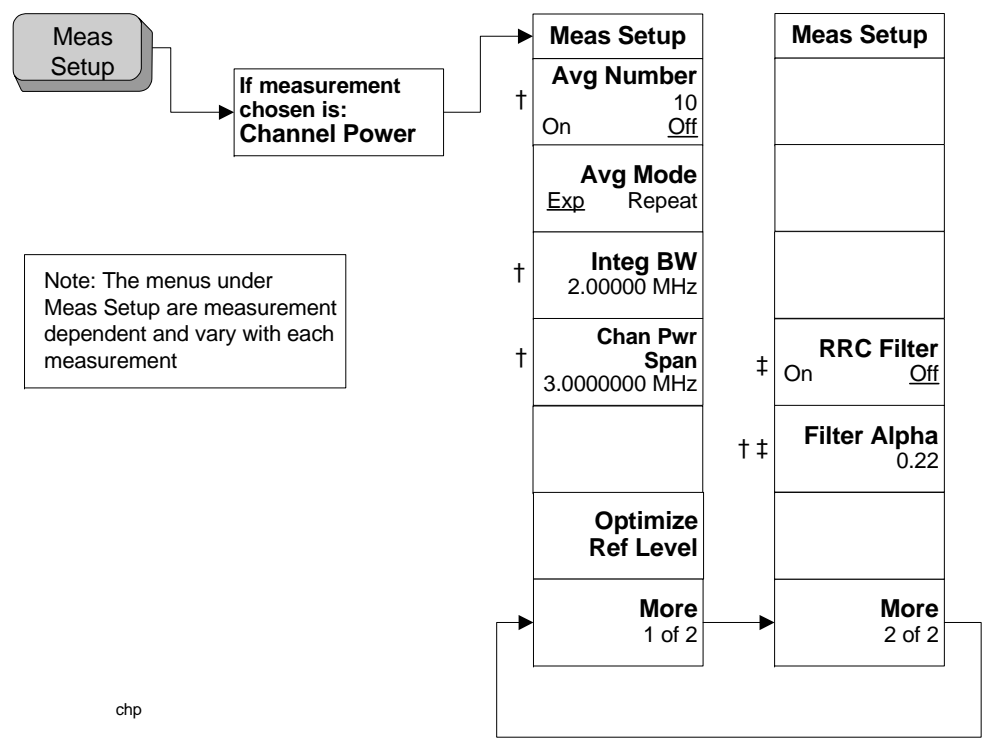

Channel Power Measurement: Trace/View Key

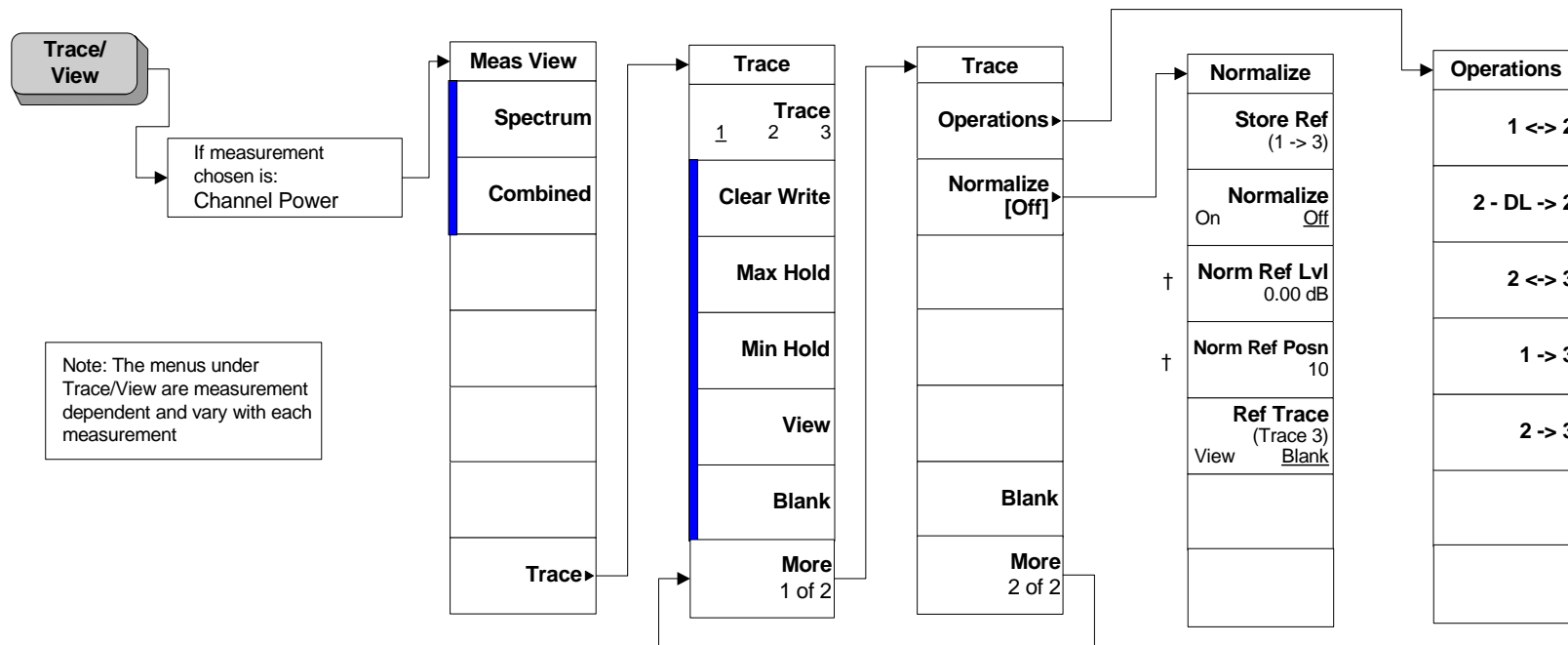

viewtrace_chp

Harmonic Distortion Measurement: Meas Setup Key

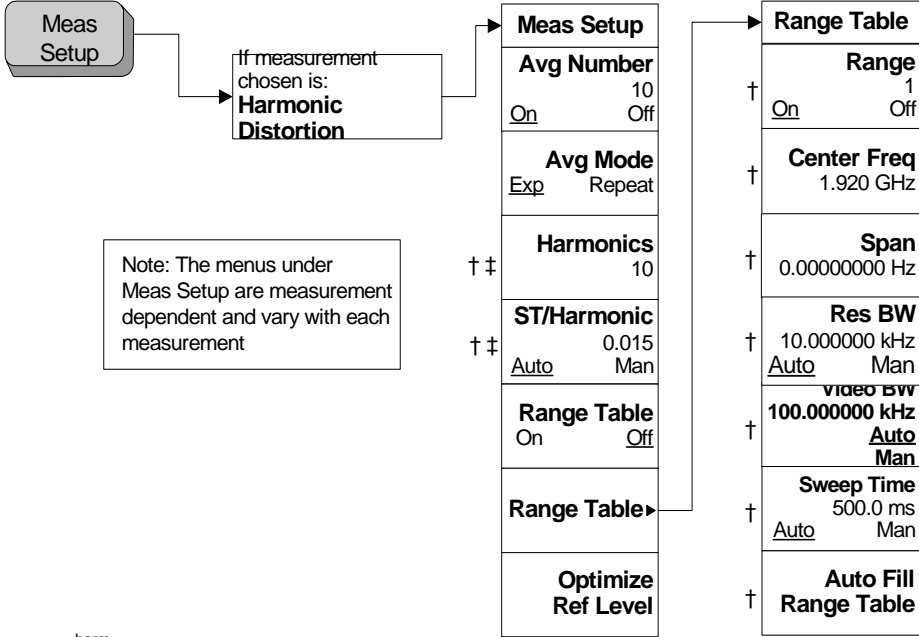

Note: The menus under Meas Setup are measurement dependent and vary with each measurement

harm

Harmonic Distortion Measurement: Trace/View Key

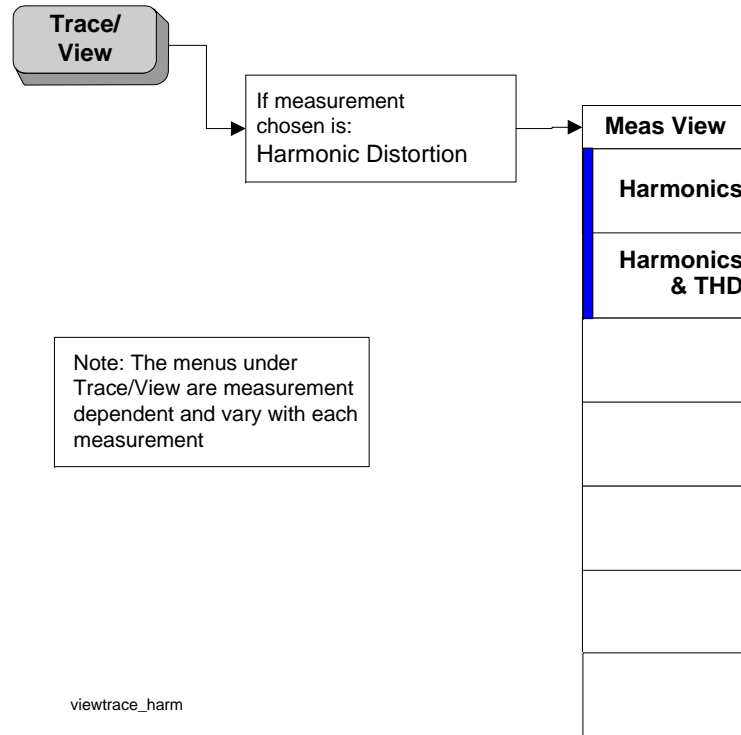

Intermod (TOI): Meas Setup Key

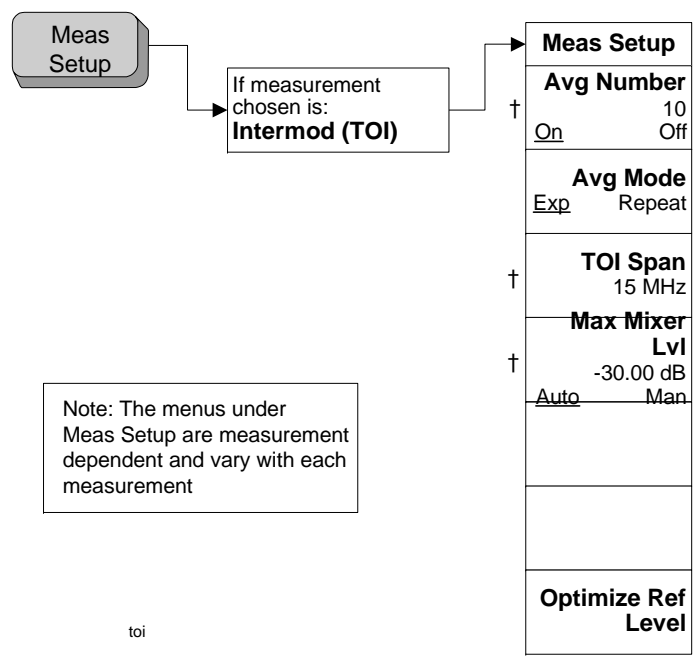

Note: The menus under Meas Setup are measurement dependent and vary with each measurement

toi

Multi-Carrier Power Measurement: Meas Setup Key

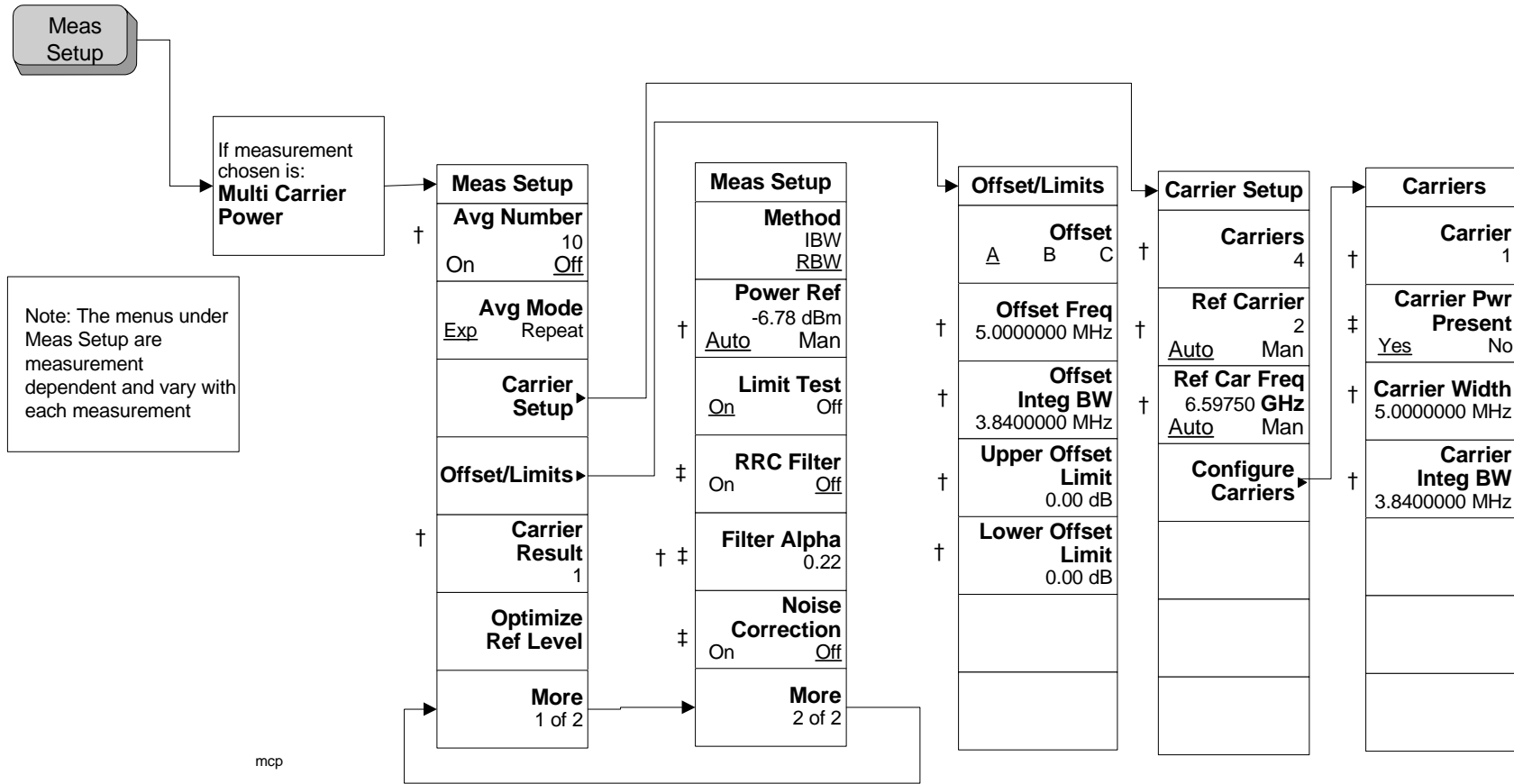

Multi-Carrier Power Measurement: Trace/View Key

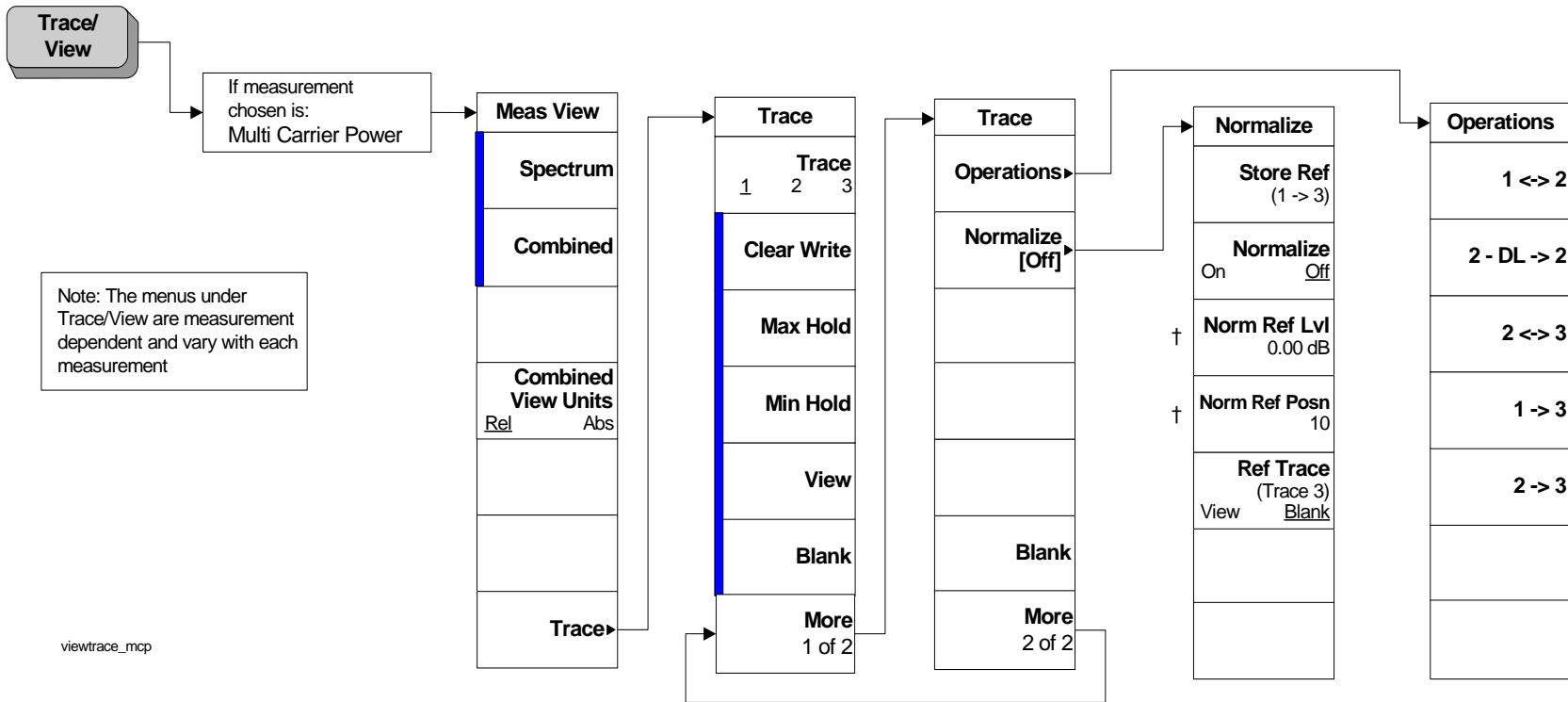

Occupied Bandwidth Measurement: Meas Setup Key

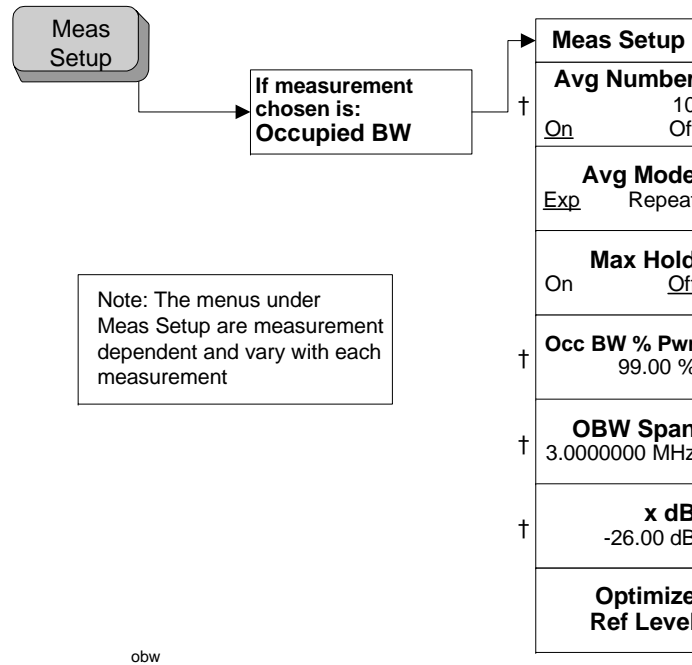

Spectrum Emission Mask Measurement: Meas Setup Key

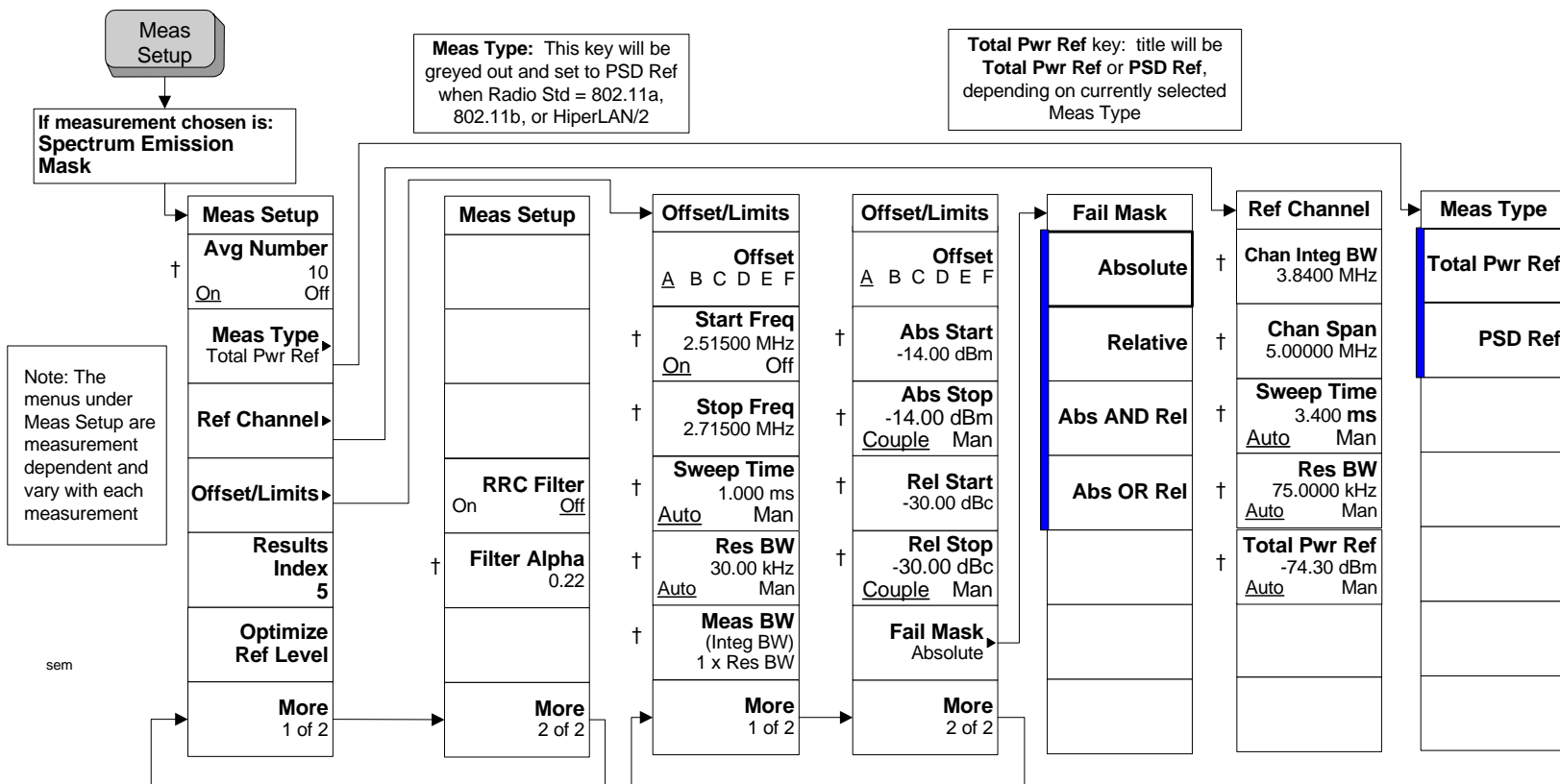

Spectrum Emission Mask Measurement: Display Key

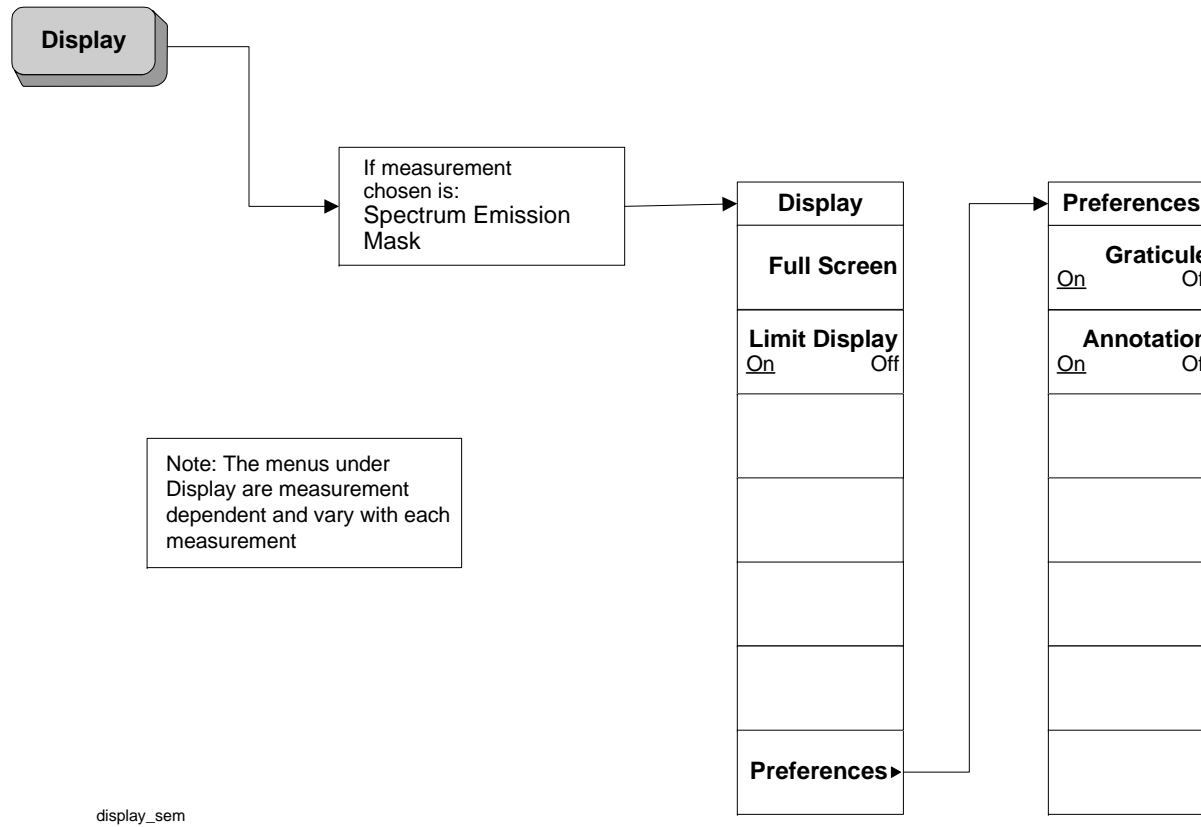

Spectrum Emission Mask Measurement: Marker Key

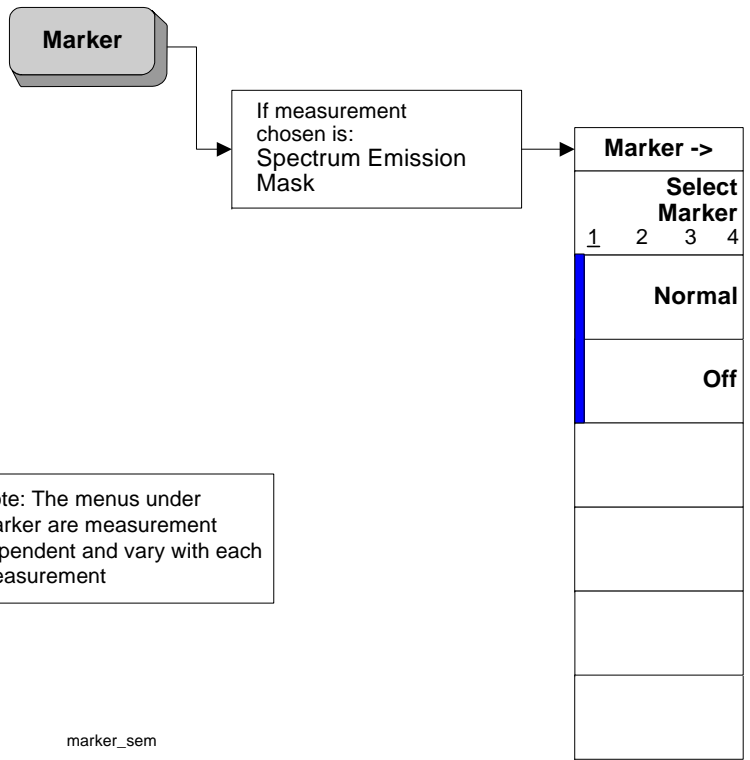

Note: The menus under Marker are measurement dependent and vary with each measurement

marker_sem

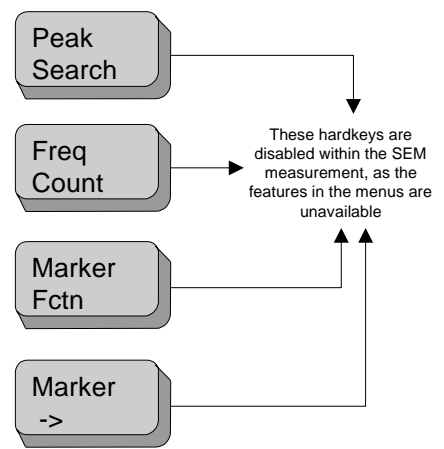

Spectrum Emission Mask Measurement: Span X Scale Key

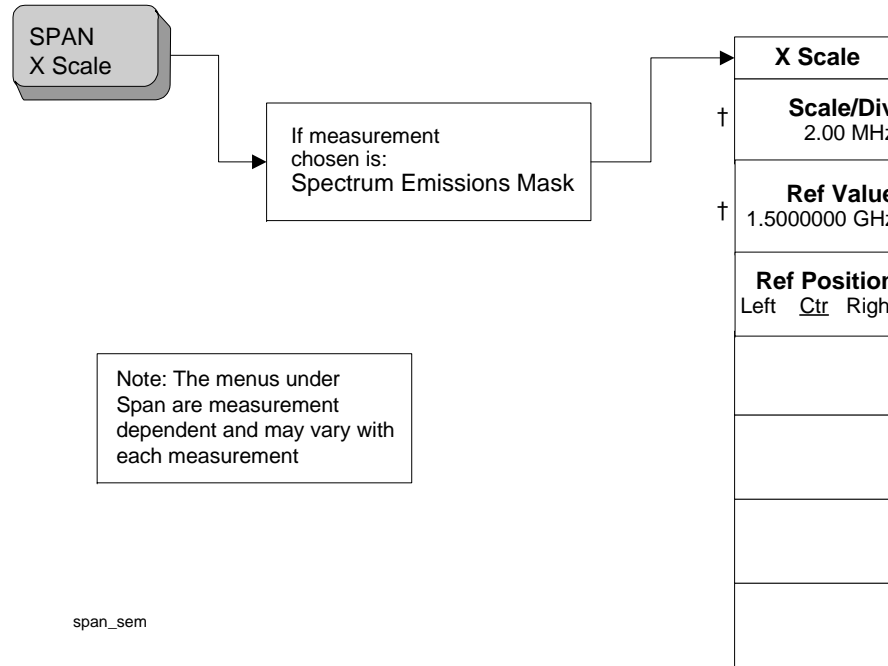

Note: The menus under Span are measurement dependent and may vary with each measurement

span_sem

Spectrum Emission Mask Measurement: Trace/View Key

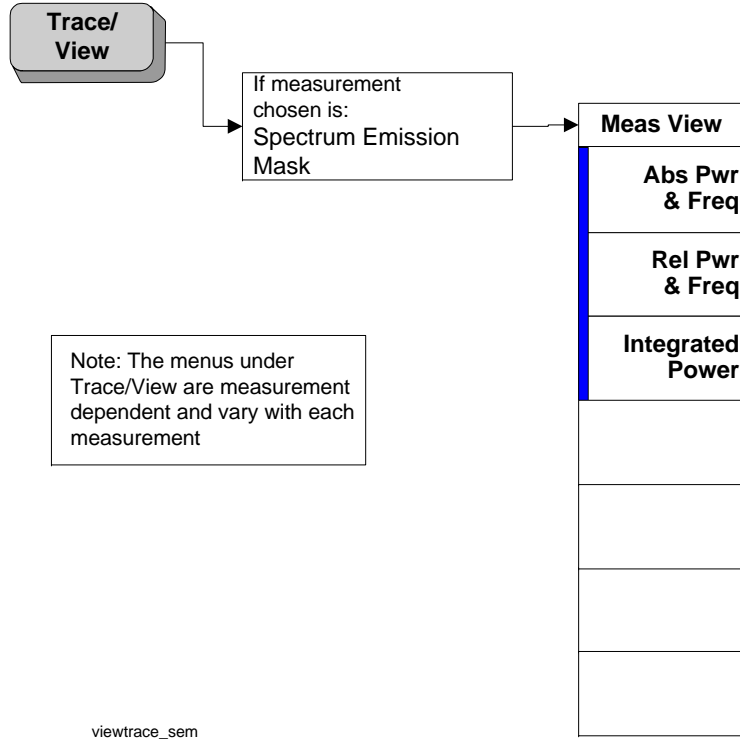

Spurious Emissions Measurement: Meas Setup Key

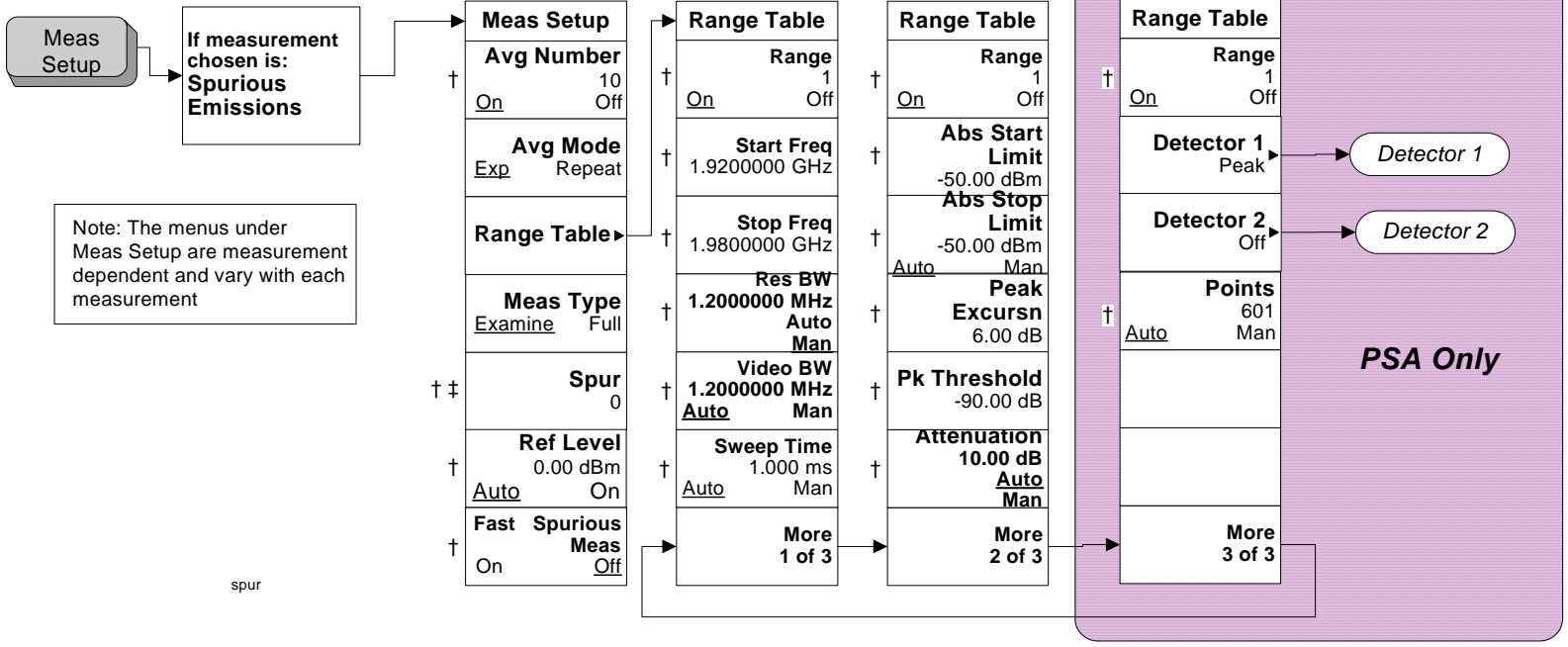

Spurious Emissions Measurement: Meas Setup Key (2 of 2)

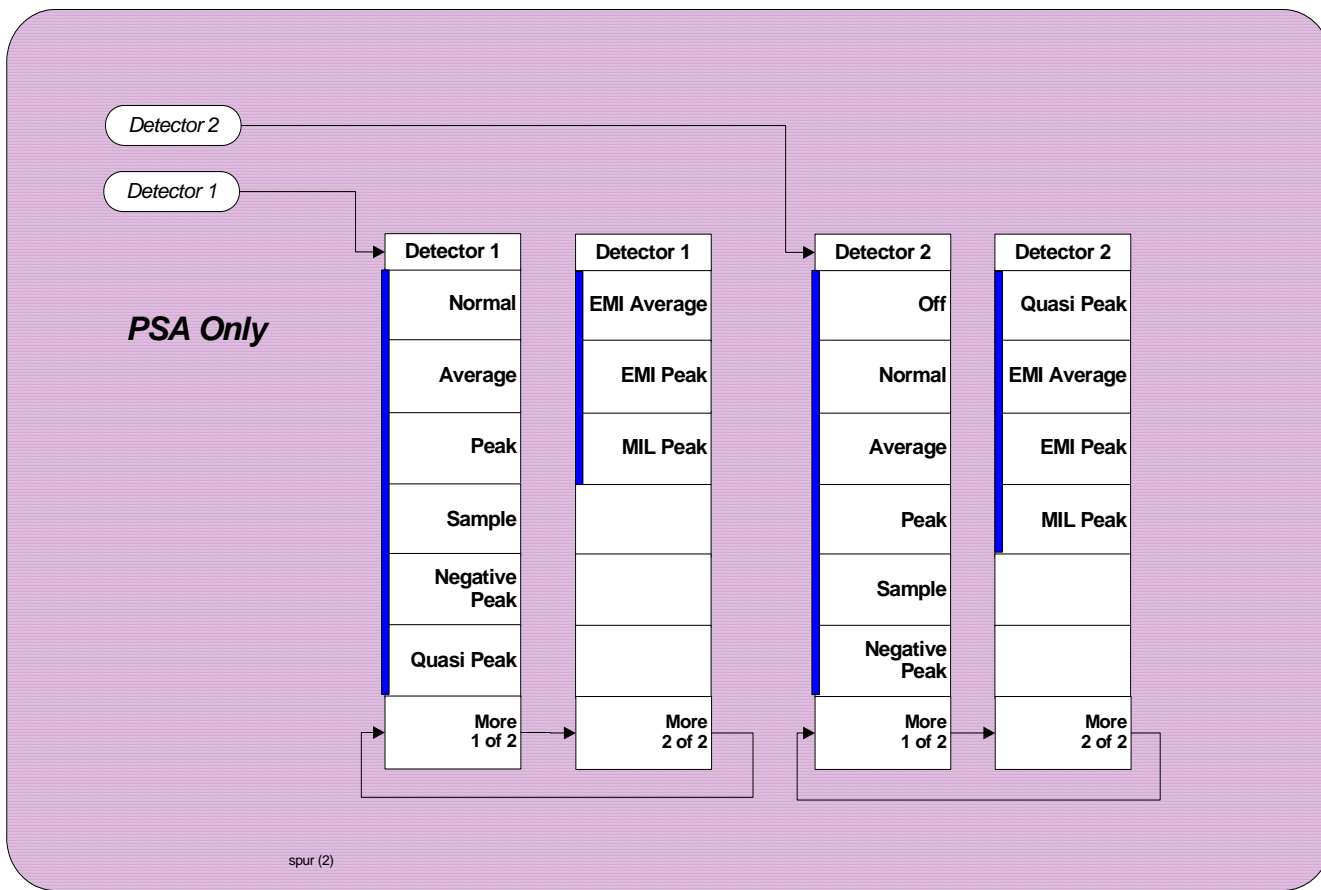

Spurious Emissions Measurement: Display

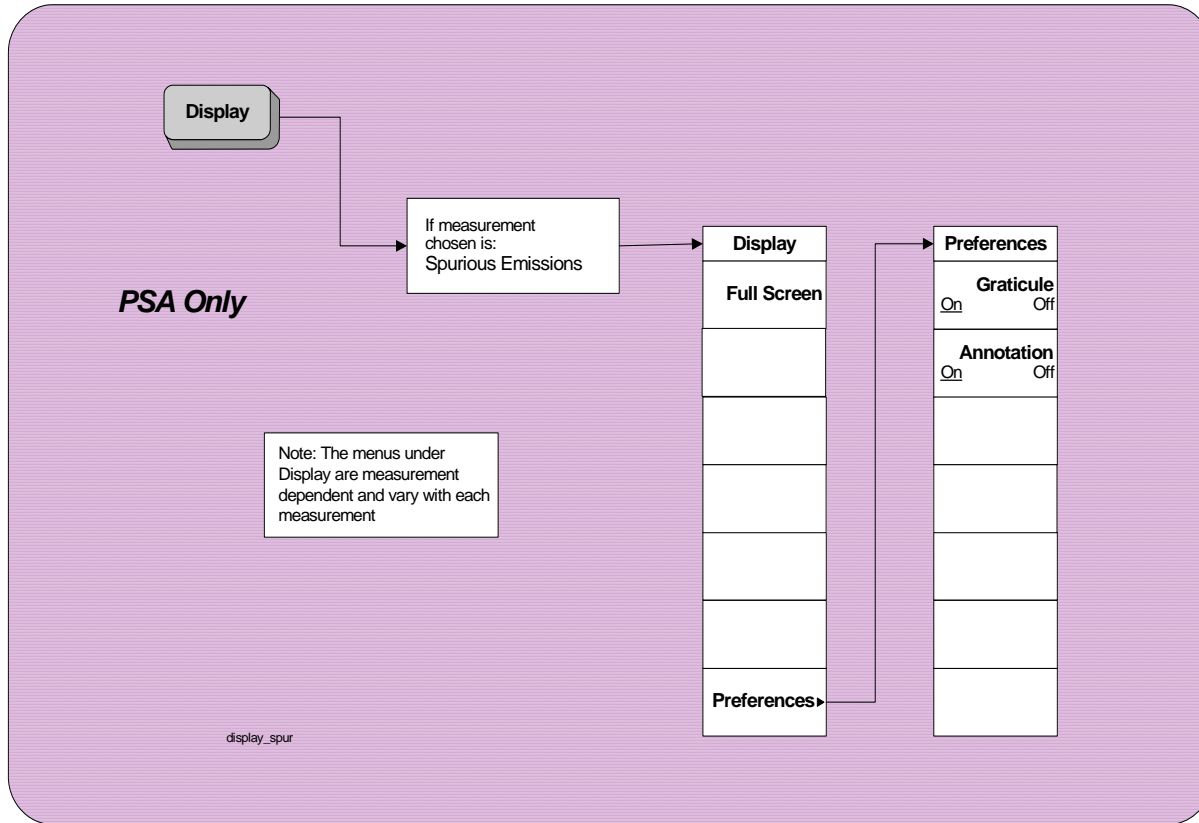

Spurious Emissions Measurement: Marker

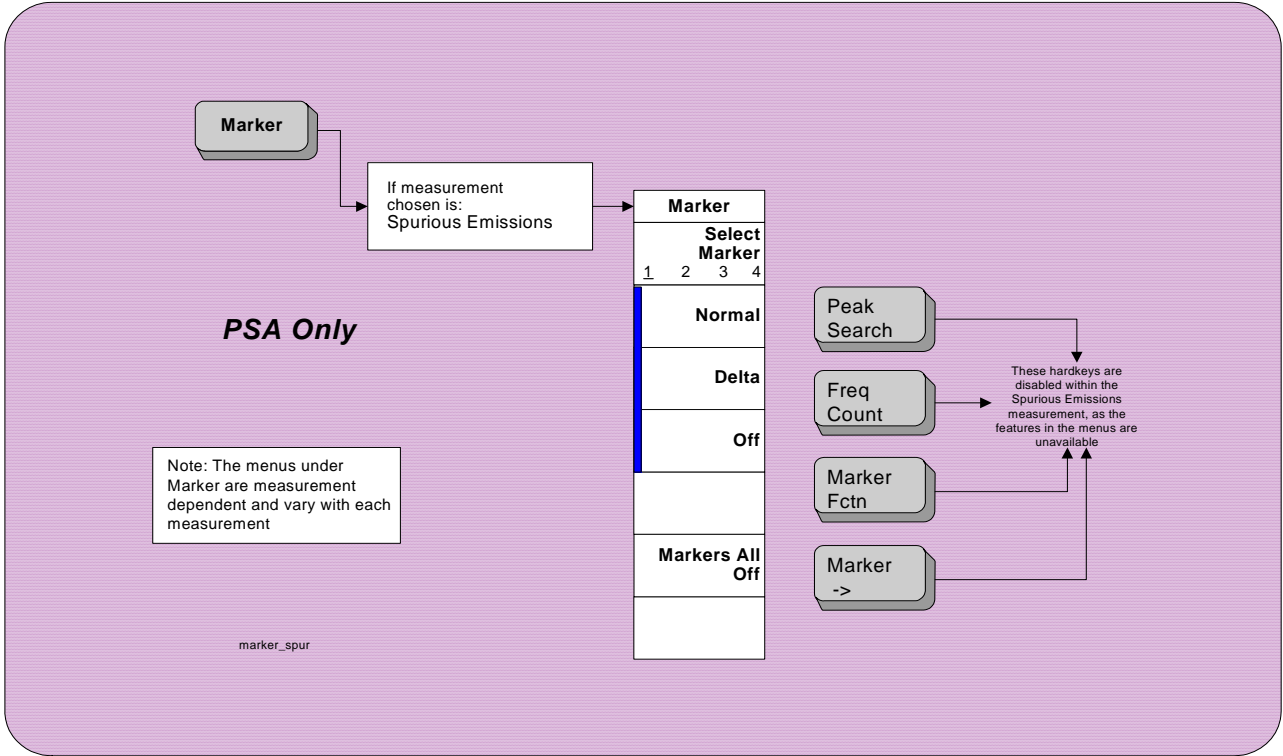

Menu Maps: One-Button Measurement Functions
One-Button Measurement Menu Maps

Symbols

*RST, 27

Numerics

3GPP W-CDMA key, 36

802.11a key, 40

802.11b key, 41

802.11g key, 41

A

absolute limit, 202, 203

Absolute Limit key, 202, 203

ACP

Meas Setup menu, 230

Trace/View menu, 231

ACP key, 58

adjacent channel power

key, 58

measurement, 58

measurement setup, 83

adjacent channel power measurement

measurement setup, 101

trace, 99

viewing trace, 99

alpha, 125

Annotation key, 190, 216

attenuation

range, 205

Attenuation key, 205

Average key, 208

average mode, 84, 102, 130, 148, 197

average number, 83, 123, 147, 197

averaging

traces, 165, 166

Avg Mode key, 84, 102, 130, 148,

166, 197

Avg Number key, 83, 101, 123, 129,

143, 147, 165, 171, 197

B

Band Class key, 46

base station setup, 45

Bluetooth key, 39

book

terms, 27

book, using, 27

Burst Power

Meas Setup menu, 232

Trace/View menu, 233

burst power measurement, trace/view,
107

BW/Avg front-panel key, 115, 116,

117, 118, 191, 217, 218, 219,

220

C

Carrier IntegBW key, 154

Carrier key, 152

Carrier Pwr Present key, 152

Carrier Result key, 158

Carrier Setup key, 149

Carrier Width key, 153

Carriers key, 149

CCDF (Power Stat)

Display menu, 235

Marker menu, 236

Meas Setup menu, 234

SPAN X Scale menu, 237

Trace/View menu, 238

CCDF measurement

Display key, 113

display settings, 113

cdma2000 SR1 key, 37

cdma2000 SR3-DS key, 38

cdma2000 SR3-MC key, 37

Cell

band class, 46

Center Freq key, 134

center frequency, 134

Chan Integ BW key, 84

Chan Integ Bw key, 173

Chan Pwr Span key, 121, 125

Chan Span key, 173

changing

frequency span, 195, 196

Channel Power

Meas Setup menu, 239

Trace/View menu, 240

Channel Power key, 54

channel power measurement, 54

measurement setup, 123

trace, 139

viewing trace, 139

channel power span, 121, 125

Combined key, 108

commands

CONFigure, 51

FETCh, 52

MEASure, 51

READ, 52, 53

complementary cumulative distribution

function measurement

measurement setup, 109

Configure Carriers key, 152

CONFigure commands, 51

Counts key, 110

couplings, 27

current measurement, query, 53

D

data acquisition sampling points, 110

default values, setting remotely, 51

definitions

dependencies/couplings, 27

example, 27

factory preset, 27

maximum value, 27

remote command, 27

state saved, 27

terms, 27

Delta key, 117, 218

dependencies, 27

Dependencies/Couplings term, 27

Detector

1, 206, 207

2, 206, 207

detector

average, 208

EMI average, 210

EMI peak, 210

negative peak, 209

normal, 207

Off, 210

quasi peak, 209

sample, 209

Detector key, 206, 207

Device BTS/MS key, 45

Display front-panel key, 113, 189, 215

documentation, using, 27

DVB-T key, 42

E

Edge Freq key, 85

EDGE measurement, 36

EMI Average key, 210

EMI Peak key, 210

Enable All Measurements key, 47

Example term, 27

expanding

display screen, 113, 189, 215

F

Factory Preset term, 27

fail mask condition

absolute limit, 185

absolute limit AND relative limit,

185

absolute limit OR relative limit, 185

relative limit, 185

Fast key, 92

Fast Spurious Test key, 213

fast spurious testing, 213

FCC Part 15 key, 40

FETCh commands, 52

Filter Alpha key, 97, 128, 161, 188

frequency offset, ACP, 85

front-panel features (see Getting

Started guide), 27

front-panel key

- Display, 113, 189, 215
- Input/Output, 144, 145
- Marker, 115, 191, 217
- Meas Setup, 83, 101, 109, 123, 129, 143, 147, 165, 171, 197
- Mode Setup, 33
- SPAN X Scale, 121, 195
- Trace/View, 99, 107, 139, 141, 163, 193
- front-panel keys
 - Input/Output, 62, 64, 70, 73, 74, 75
 - MEASURE, 49
- Full Screen key, 113, 189, 215

- G**
- G/PAL/NICAM, 43
- gaussian trace, 114
- Gaussian Trace key, 114
- GSM/EDGE key, 36

- H**
- handset setup, 45
- Harmonic Dist key, 67
- Harmonic Distortion
 - Meas Setup menu, 241
 - Trace/View menu, 242
- harmonic distortion
 - key, 67
 - measurement, 67
- harmonic distortion measurement
 - measurement setup, 129
- harmonics key, 130
- Hiper LAN/2 key, 42

- I**
- I/PAL/NICAM, 43
- IBW key, 91
- Input/Output front-panel key, 62, 64, 70, 73, 74, 75, 144, 145
- integration bandwidth, 124
- Integration BW key, 124
- IS95 key, 34, 35

- J**
- J-STD-008 key, 35
- jSystem E key, 44

- L**
- L/SECAM/NICAM, 42
- Last Span key, 196
- limit line testing, 53
- Limit Test key, 96, 160
- limits
 - fail mask condition, 185, 186
- Lower Offset Limit key, 157

- M**
- manual, using, 27
- marker
 - X position, 119, 120
- Marker All Off key, 118, 219
- marker control mode
 - Delta, 117, 218
 - Normal, 116, 192, 218
- Marker front-panel key, 115, 191, 217
- Marker Mode key, 220
- Marker Trace key, 118
- markers
 - all off, 118, 219
 - mode, 220
 - off, 117, 118, 192, 219
 - selecting, 116, 118, 191, 217
 - set mode, 220
 - trace assignment, 118
- markers off, 116, 191
- Max Hold key, 166
- Maximum Value term, 27
- Meas BW key, 109
- Meas Control
 - menu, 225
- Meas Interval key, 111
- Meas Off key, 54
- Meas Setup
 - ACP Measurement, 83, 101
 - CCDF Measurement, 109
 - Channel Power Measurement, 123
 - Harmonic Distortion Measurement, 129
 - Occupied BW Measurement, 143, 165, 171, 197
- Meas Setup front-panel key, 83, 101, 109, 123, 129, 143, 147, 165, 171, 197
- Meas Type key, 89, 172, 211
- MEASURE
 - menu, 224
- MEASure commands, 51
- MEASURE front-panel key, 49
- measure setup
 - frequency span, 144
 - spectrum segment
 - offset
 - offsets and limits, 175
- measurement bandwidth, 109
- measurement reference type
 - power spectral density reference, 172
 - total power reference, 172
- measurement time interval, 111
- measurements
 - adjacent channel power, 58
 - burst power, 107
 - channel power, 54
 - harmonic distortion, 67
 - multi-carrier power, 147
 - occupied bandwidth, 57
 - query current, 53
 - setting default values remotely, 51
- menu map
 - ACP
 - Meas Setup key, 230
 - Trace/View key, 231
 - Burst Power
 - Meas Setup key, 232
 - Trace/View key, 233
 - CCDF (Power Stat)
 - Display key, 235
 - Marker key, 236
 - Meas Setup key, 234
 - SPAN X Scale key, 237
 - Trace/View key, 238
 - Channel Power
 - Meas Setup key, 239
 - Trace/View key, 240
 - Harmonic Distortion
 - Meas Setup key, 241
 - Trace/View key, 242
 - Meas Control, 225
 - MEASURE, 224
 - Mode Setup, 226, 227, 228, 229
 - Multi-Carrier Power
 - Meas Setup key, 244
 - Trace/View key, 245
 - Occupied Bandwidth
 - Meas Setup key, 246
 - Spectrum Emission Mask
 - Display key, 248
 - Marker key, 249
 - Meas Setup key, 247
 - SPAN X Scale key, 250
 - Trace/View key, 251
 - Spurious Emissions
 - Meas Setup key, 252, 253, 254, 255
 - Third Order Intercept
 - Meas Setup key, 243
- Method key, 91, 159
- mobile station setup, 45
- mode
 - points, 211
- Mode Setup
 - menu, 226, 227, 228, 229
- Mode Setup front-panel key, 33
- moving
 - trace data, 141, 193, 194
- multi carrier power measurement
 - trace, 163
 - viewing trace, 163
- Multi-Carrier Power

- Meas Setup menu, 244
- Trace/View menu, 245
- multi-carrier power measurement
 - measurement setup, 147
- N**
- NADC key, 38
- Neg Offset Limit key, 89
- Negative Peak key, 209
- Noise Corr key, 97
- noise correction, 97, 162
- Noise Correction key, 162
- None key, 34
- Normal key, 116, 192, 207, 218
- O**
- OBW Span key, 167
- Occ BW % Pwr key, 167
- Occupied Bandwidth
 - Meas Setup menu, 246
- occupied bandwidth measurement, 57
 - measurement setup, 143, 165, 171, 197
- Occupied BW
 - measurement results, 58, 168
- Occupied BW key, 57
- Off key, 210
- Off key marker, 117, 192, 219
- Offset Freq key, 85, 156
- Offset IntegBW key, 156
- Offset key, 85, 155
- offset limit, 88, 89
- Offset/Limits key, 85
- offsets and limits
 - limits
 - absolute start level, 182
- Offsets/Limits key, 155
- one-button measurements, turn off, 54
- optimize ref level, 48, 90, 106, 112, 126, 138, 146, 158, 169, 187
- Optimize Ref Level key, 48, 90, 106, 112, 126, 138, 146, 158, 169, 187
- P**
- Packet Type key, 46, 48
- pass/fail test, 53
- PDC key, 39
- peak excursion, 204
- Peak Excursn key, 204
- peak threshold, 205
- Pk Threshold key, 205
- points
 - mode, 211
- Points key, 211
- Pos Offset Limit key, 88
- power spectral density, 95
- power stat CCDF
 - Gaussian line display, 114
- power statistics CCDF
 - measurement interval, 111
 - number of sampling points, 110
 - reference trace display, 113
 - store reference trace, 113
- Preferences key, 114, 189, 215
- programmer's reference, using, 27
- PSD Ref key, 172, 175
- Q**
- Quasi Peak key, 209
- R**
- Radio Std Setup key, 45
- range
 - attenuation, 205
- Range key, 131, 133, 199
- range table, 131, 132, 133, 198, 199
- Range Table key, 132, 198
- READ commands, 52, 53
- rear-panel features (see Getting Started guide), 27
- Ref BW key, 87
- Ref Carrier Freq key, 150
- Ref Carrier key, 149
- Ref Channel key, 173
- Ref Level key, 213
- Ref Trace key, 113
- reference bandwidth, 87
- reference level, 213
- reference trace, 113
- reference trace, storing, 113
- Remote Command term, 27
- Res BW key, 135, 174, 201
- resolution bandwidth, 135, 201
- Retain Params key, 47
- RF Envelope key, 107
- RRC filter, 188
- RRC Filter key, 96, 126, 161, 187
- RST term, 27
- S**
- Sample key, 209
- saved
 - state, 27
- saving
 - trace data, 141, 193, 194
- S-DMB key, 43, 44, 91
- Select Marker key, 116, 191, 217
- selecting
 - marker pairs, 116, 191, 217
 - markers, 116, 191, 217
 - Marker Trace, 118
- SEM measurement
 - Display key, 189
 - display settings, 189
 - trace, 141, 193
 - viewing trace, 141, 193
- Signal BW key, 45
- span, 134
- Span key, 134, 195
- SPAN X Scale front-panel key, 121, 195
- spectral density, 95
- spectrum analyzer measurements, 54
- Spectrum Emission Mask
 - Display menu, 248
 - Marker menu, 249
 - Meas Setup menu, 247
 - SPAN X Scale menu, 250
 - Trace/View menu, 251
- spectrum emission mask
 - measure setup
 - measurement reference type, 172
- Spur key, 212
- Spurious Emissions
 - Meas Setup menu, 252, 253, 254, 255
- spurious emissions measurement
 - Display key, 215
 - display settings, 215
- spurious test
 - fast, 213
- ST/Harmonic key, 131
- standards setup, 45
- Start Freq key, 200
- start frequency, 200
- state
 - saved, 27
- State Saved term, 27
- Stop Freq key, 200
- stop frequency, 200
- Store Ref Trace key, 113
- sweep time, 136, 137, 202
- Sweep Time key, 136, 137, 174, 202
- T**
- table
 - range, 132, 198
 - setting
 - range, 131, 133, 199
- terms
 - *RST, 27
 - book, 27
 - definition, 27
 - dependencies/couplings, 27
 - example, 27
 - factory preset, 27
 - maximum value, 27
 - remote command, 27

- state saved, [27](#)
- test limits, [53](#)
- testing
 - spurs, [213](#)
- TETRA key, [40](#)
- Third Order Intercept
 - Meas Setup menu, [243](#)
- Total Pwr Ref key, [94](#), [160](#), [175](#)
- Total Pwr Refl key, [172](#)
- trace
 - saving, [141](#), [193](#), [194](#)
 - transfer data, [141](#), [193](#), [194](#)
- trace averaging, [165](#), [166](#)
- trace data
 - moving, [141](#), [193](#), [194](#)
- Trace key, [100](#), [108](#), [139](#), [164](#)
- Trace/View front-panel key, [99](#), [107](#),
[139](#), [141](#), [163](#), [193](#)
- turn off one-button measurements, [54](#)
- turning markers off, [117](#), [192](#), [219](#)

U

- Upper Offset Limit key, [157](#)
- US PCS
 - band class, [46](#)
- US/K
 - band class, [46](#)
- user's reference, using, [27](#)
- UWB Indoor key, [44](#)

V

- video bandwidth, [136](#), [201](#)
- Video BW key, [136](#), [201](#)

X

- x dB key, [168](#)