

Operating Instructions

RIA45

Panel meter

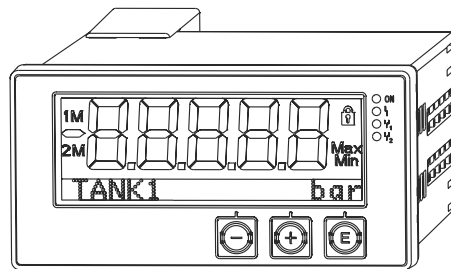

Table of contents

1	Document information	4	10	Troubleshooting	40
1.1	Document function	4	10.1	Troubleshooting instructions	40
1.2	Document conventions	4	10.2	Process error messages	40
2	Safety instructions	6	10.3	Spare parts	41
2.1	Requirements for the personnel	6	11	Return	43
2.2	Designated use	6	12	Disposal	44
2.3	Workplace safety	6	13	Technical data	45
2.4	Operational safety	6	13.1	Input	45
2.5	Product safety	7	13.2	Output	46
3	Identification	8	13.3	Power supply	47
3.1	Device designation	8	13.4	Performance characteristics	48
3.2	Scope of delivery	8	13.5	Installation	49
3.3	Certificates and approvals	8	13.6	Mechanical construction	51
4	Installation	9	13.7	Operability	52
4.1	Incoming acceptance, transport, storage	9	13.8	Certificates and approvals	53
4.2	Installation conditions	9	13.9	Documentation	53
4.3	Dimensions	9	14	Appendix	54
4.4	Installation procedure	10	14.1	Further explanations on the differential pressure application at level measurement ...	54
4.5	Post-installation check	10	14.2	Display menu	56
5	Wiring	11	14.3	Setup menu	57
5.1	Connecting the device	11	14.4	Diagnostics menu	66
5.2	Post-connection check	13	14.5	Expert menu	68
6	Operation	14	Index	75	
6.1	Operating elements	14			
6.2	Display and device status indicator/LED	16			
6.3	Icons	16			
6.4	Quick guide to the operating matrix	17			
7	Commissioning	21			
7.1	Post-installation check and switching on the device	21			
7.2	General information on the device configuration	21			
7.3	Notes on setup access protection	21			
7.4	Configuring the device	22			
7.5	In operation	35			
8	Maintenance	38			
9	Accessories	39			
9.1	Device-specific accessories	39			
9.2	Communication-specific accessories	39			





1 Document information

1.1 Document function







These Operating Instructions contain all the information that is required in various phases of the life cycle of the device: from product identification, incoming acceptance and storage, to mounting, connection, operation and commissioning through to troubleshooting, maintenance and disposal.

1.2 Document conventions











1.2.1 Safety symbols

Symbol	Meaning
	DANGER! This symbol alerts you to a dangerous situation. Failure to avoid this situation will result in serious or fatal injury.
	WARNING! This symbol alerts you to a dangerous situation. Failure to avoid this situation can result in serious or fatal injury.
	CAUTION! This symbol alerts you to a dangerous situation. Failure to avoid this situation can result in minor or medium injury.
	NOTE! This symbol contains information on procedures and other facts which do not result in personal injury.





1.2.2 Electrical symbols

Symbol	Meaning
 A0011197	Direct current A terminal to which DC voltage is applied or through which direct current flows.
 A0011198	Alternating current A terminal to which alternating voltage is applied or through which alternating current flows.
 A0017381	Direct current and alternating current <ul style="list-style-type: none"> ▪ A terminal to which alternating voltage or DC voltage is applied. ▪ A terminal through which alternating current or direct current flows.
 A0011200	Ground connection A grounded terminal which, as far as the operator is concerned, is grounded via a grounding system.
 A0011199	Protective ground connection A terminal which must be connected to ground prior to establishing any other connections.
 A0011201	Equipotential connection A connection that has to be connected to the plant grounding system: This may be a potential equalization line or a star grounding system depending on national or company codes of practice.
 A0012751	ESD - Electrostatic discharge Protect the terminals against electrostatic discharge. Failure to comply with this instruction can result in the destruction of parts or malfunction of the electronics.



1.2.3 Symbols for certain types of information

Symbol	Meaning
	Permitted Procedures, processes or actions that are permitted.
	Preferred Procedures, processes or actions that are preferred.
	Forbidden Procedures, processes or actions that are forbidden.
	Tip Indicates additional information.
	Reference to documentation
	Reference to page
	Reference to graphic
	Series of steps
	Result of a sequence of actions
	Help in the event of a problem
	Visual inspection

1.2.4 Symbols in graphics

Symbol	Meaning
1, 2, 3,...	Item numbers
	Series of steps
A, B, C, ...	Views
A-A, B-B, C-C, ...	Sections
 A0013441	Flow direction
 A0011187	Hazardous area Indicates a hazardous area.
 A0011188	Safe area (non-hazardous area) Indicates a non-hazardous area.

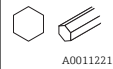
1.2.5 Tool symbols

Symbol	Meaning
 A0011220	Flat blade screwdriver
 A0011221	Allen key
 A0011222	Open-ended wrench
 A0013442	Torx screwdriver

2 Safety instructions

2.1 Requirements for the personnel

The personnel for installation, commissioning, diagnostics and maintenance must fulfill the following requirements:

- ▶ Trained, qualified specialists must have a relevant qualification for this specific function and task
- ▶ Are authorized by the plant owner/operator
- ▶ Are familiar with federal/national regulations
- ▶ Before beginning work, the specialist staff must have read and understood the instructions in the Operating Instructions and supplementary documentation as well as in the certificates (depending on the application)
- ▶ Following instructions and basic conditions

The operating personnel must fulfill the following requirements:

- ▶ Being instructed and authorized according to the requirements of the task by the facility's owner-operator
- ▶ Following the instructions in these Operating Instructions

2.2 Designated use

The device evaluates analog process variables and shows them on its multicolored display. Using the unit's outputs and limit relays, processes can be monitored and controlled. The device is equipped with a wide range of software functions for this purpose. Power can be supplied to 2-wire sensors with the integrated loop power supply.

- The device is seen as an associated apparatus and may not be installed in hazardous areas.
- The manufacturer accepts no liability for damages resulting from incorrect use or use other than that designated. The device may not be converted or modified in any way.
- The device has been designed for panel installation and may only be operated in an installed state.

2.3 Workplace safety

For work on and with the device:

- ▶ Wear the required personal protective equipment according to federal/national regulations.

2.4 Operational safety

Risk of injury.

- ▶ Operate the device in proper technical condition and fail-safe condition only.
- ▶ The operator is responsible for interference-free operation of the device.

Conversions to the device

Unauthorized modifications to the device are not permitted and can lead to unforeseeable dangers.

- ▶ If, despite this, modifications are required, consult with Endress+Hauser.

Repair

To ensure continued operational safety and reliability,

- ▶ Carry out repairs on the device only if they are expressly permitted.
- ▶ Observe federal/national regulations pertaining to repair of an electrical device.
- ▶ Use original spare parts and accessories from Endress+Hauser only.

Environmental requirements

If a plastic transmitter housing is permanently exposed to certain steam and air mixtures, this can damage the housing.

- ▶ If you are unsure, please contact your Endress+Hauser Sales Center for clarification.
- ▶ If used in an approval-related area, observe the information on the nameplate.

2.5 Product safety

This measuring device is designed in accordance with good engineering practice to meet state-of-the-art safety requirements, has been tested, and left the factory in a condition in which it is safe to operate.

It meets general safety standards and legal requirements. It also complies with the EC directives listed in the device-specific EC Declaration of Conformity. Endress+Hauser confirms this by affixing the CE mark to the device.

3 Identification

3.1 Device designation

3.1.1 Nameplate

Compare the nameplate on the device with the following diagram:

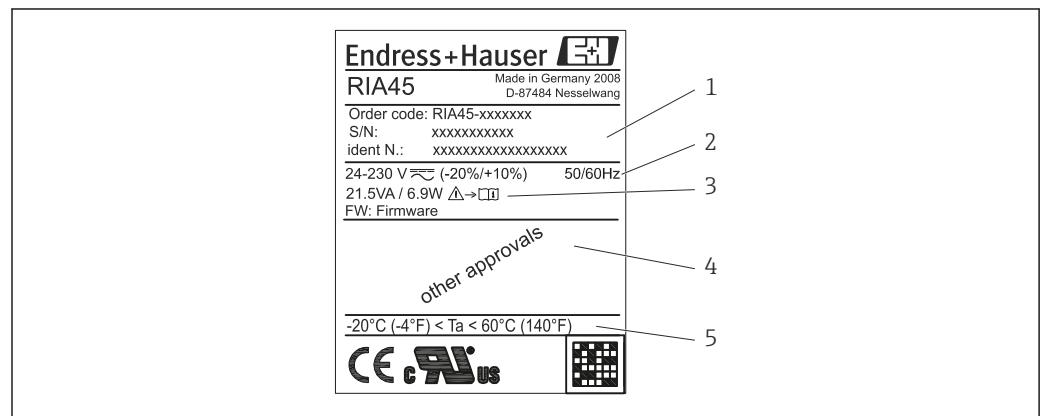

A0010405

- 1 Nameplate of the device (sample)
- 1 Order code, serial number and ID number of the device
- 2 Power supply
- 3 Power consumption
- 4 Approval
- 5 Temperature range

3.2 Scope of delivery

The scope of delivery of the process indicator comprises:

- Panel meter for panel mounting
- Hard copy of Brief Operating Instructions and Ex documentation (XA)
- Fastening material
- Distance piece for terminals (Ex option)

 Please note the device accessories in Section 'Accessories'.

3.3 Certificates and approvals

CE mark, Declaration of Conformity

The device is designed to meet state-of-the-art safety requirements, has been tested and left the factory in a condition in which it is safe to operate. The device meets the relevant standards and directives as per EN 61 010-1 "Safety requirements for electrical equipment for measurement, control and laboratory use".

Thus, the device described in these Operating Instructions meets the legal requirements of the EU directives. The manufacturer confirms successful testing of the device by affixing to it the CE mark.

An overview of all the certificates and approvals available can be found in the Section "Technical data" →  53.

4 Installation

4.1 Incoming acceptance, transport, storage

The permitted ambient and storage conditions must be observed. The precise specifications can be found in Section "Technical data".

4.1.1 Incoming acceptance

On receipt of the goods, check the following points:

- Are the packaging or contents damaged?
- Is anything missing from the delivery? Compare the scope of delivery with the information you specified in the order.

4.1.2 Transportation and storage

Note the following points:

- Pack the device so that is protected against impact for storage and transportation. The original packaging provides optimum protection.
- The permitted storage temperature range is -40 to 85 °C (-40 to 185 °F); it is possible to store the device in the limit temperature ranges for a limited period (maximum 48 hours).

4.2 Installation conditions

NOTICE

The life-time of the display is shortened when operated in the upper temperature range.

- ▶ To avoid heat accumulation, always make sure the device is sufficiently cooled.
- ▶ Do not operate the device in the upper temperature range over a longer period of time.

The device is designed to be used in a panel.

The orientation is determined by the readability of the display. Connections and outputs are fitted on the rear of the device. The wires are connected by means of number-coded terminals.

Operational temperature range:

Non-Ex/Ex devices: -20 to 60 °C (-4 to 140 °F)

UL devices: -20 to 50 °C (-4 to 122 °F)

4.3 Dimensions

Observe the installation depth of 150 mm (5.91 in) for the device incl. terminals and fastening clips.

In the case of devices with Ex approval, the Ex frame provided is mandatory and an installation depth of 175 mm (6.89 in) must be observed. More dimensions can be found in Section "Technical data".

- Panel cutout: 92 mm (3.62 in) x 45 mm (1.77 in).
- Panel thickness: max. 26 mm (1 in).
- Max. viewing angle range: 45° to the left and right from the central display axis.
- If the devices are arranged horizontally beside one another in the X-direction, or arranged vertically on top of one another in the Y-direction, the mechanical distance (specified by the housing and front section) must be observed.

4.4 Installation procedure

The panel cutout required measures 92 mm (3.62 in) x 45 mm (1.77 in)

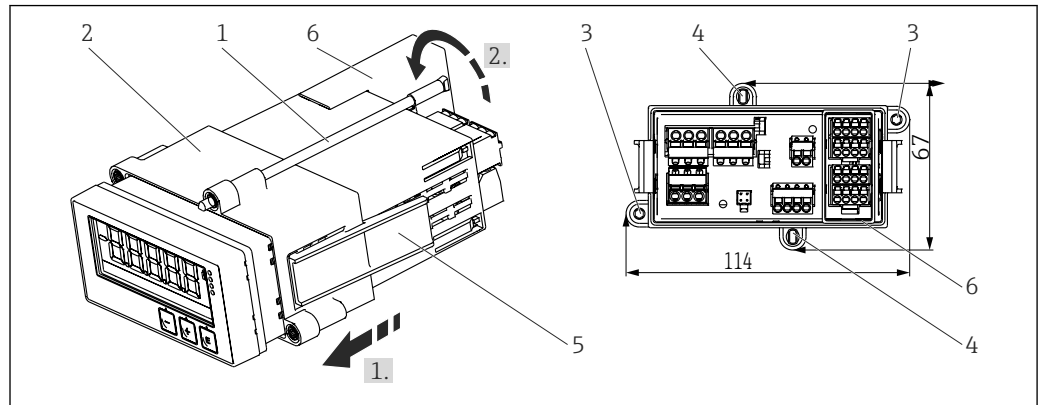

2 Installation in the panel

1. Screw the threaded rods (pos. 1) into the positions provided on the mounting frame (pos. 2). Four opposing screw positions (pos. 3/4) are available for this purpose.
2. Push the device through the panel cutout from the front.
3. To secure the casing in the panel, hold the device in a horizontal position and push the frame (pos. 2), with the threaded rods screwed in, over the casing until the frame locks into position (1.).
4. Then tighten the threaded rods to fix the device in place (2.).
5. or the Ex option, install the distance piece (pos. 6) for the input terminals.

To disassemble the device, the mounting frame can be unlocked at the locking elements (pos. 5) and then removed.

4.5 Post-installation check

- Is the sealing which is spray-applied to the casing undamaged?
- Is the mounting frame securely engaged on the housing of the device?
- Are the threaded rods tightened?
- Is the device positioned in the center of the panel cutout?
- Is the distance piece installed (Ex option)?

5 Wiring

⚠ WARNING

Danger! Electric voltage!

- ▶ The entire connection of the device must take place while the device is de-energized.
- ▶ The ground connection must be made before all other connections. Danger if protective ground is disconnected.
- ▶ Before commissioning the device, make sure that the supply voltage matches the voltage specifications on the nameplate.
- ▶ Provide suitable switch or circuit breaker in building installation. This switch must be provided close to the device (within easy reach) and marked as a circuit breaker.
- ▶ Provide overload protection (nominal current ≤ 10 A) for power cable.

- i** ▪ Observe the terminal designation on top of the device.
- It is permitted to connect a mixture of safety extra low voltage and voltage which poses a shock hazard to the relays.

5.1 Connecting the device

A loop power supply (LPS) is provided for every input. The loop power supply is primarily provided to supply power to 2-wire sensors and is galvanically isolated from the system and the outputs.

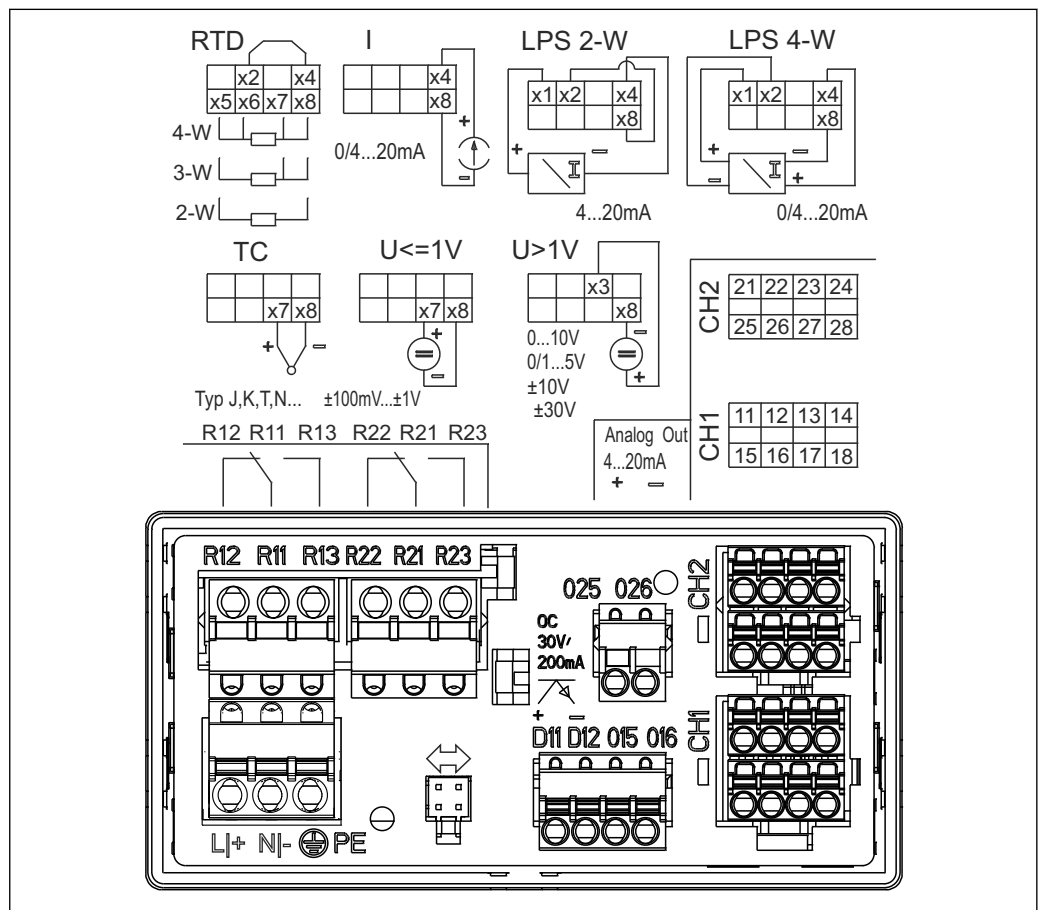

3 Terminal assignment of the device (channel 2 and relays as an option)

- i** If long signal cables with high-energy transients can be expected, we recommend fitting a suitable surge arrester upstream.

5.1.1 Overview of possible connection options at the device

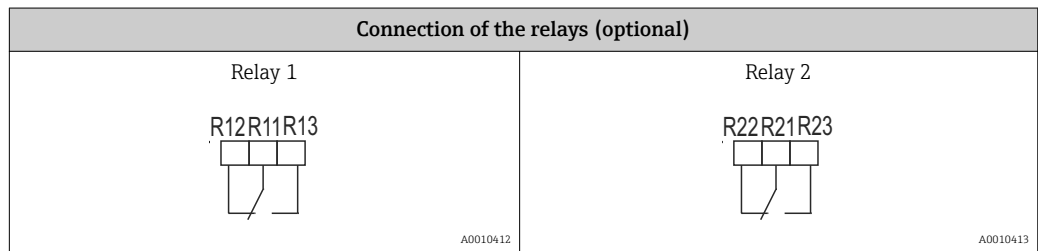
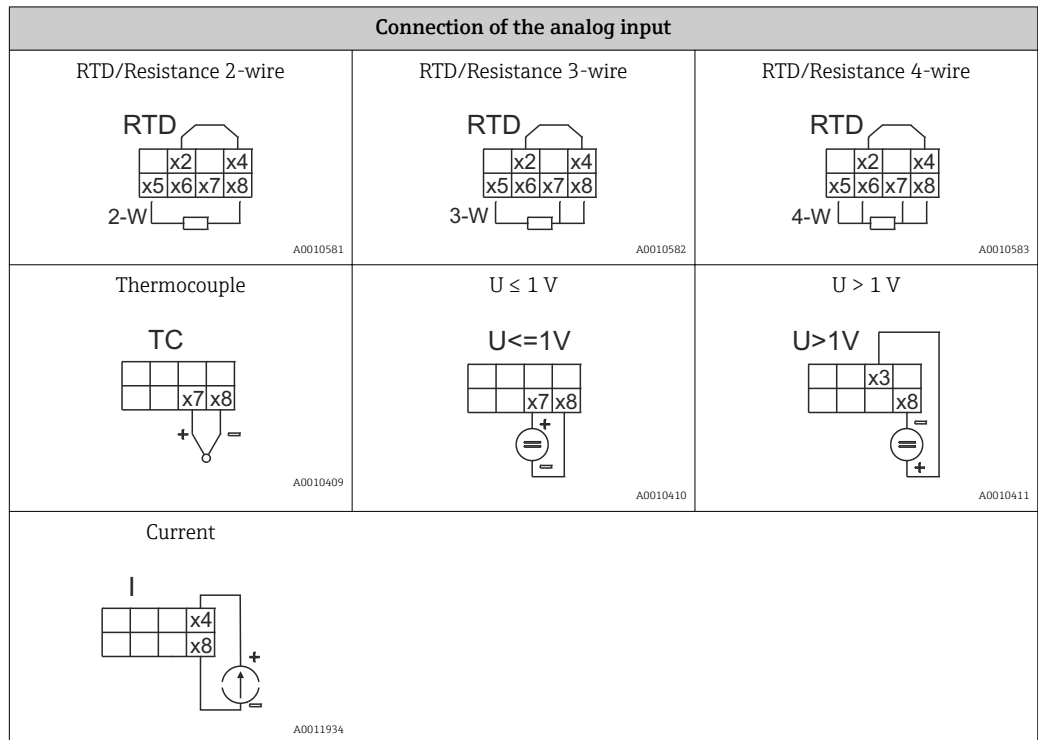
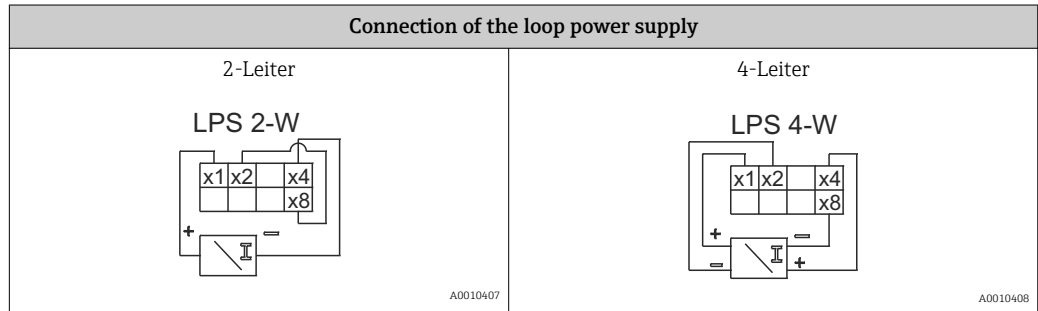
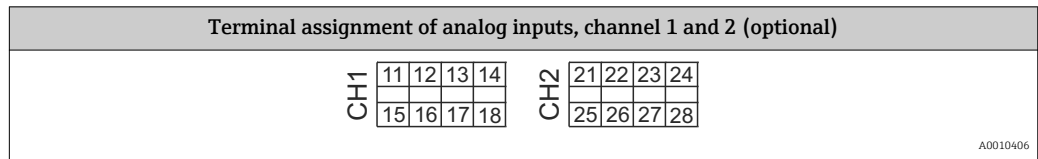

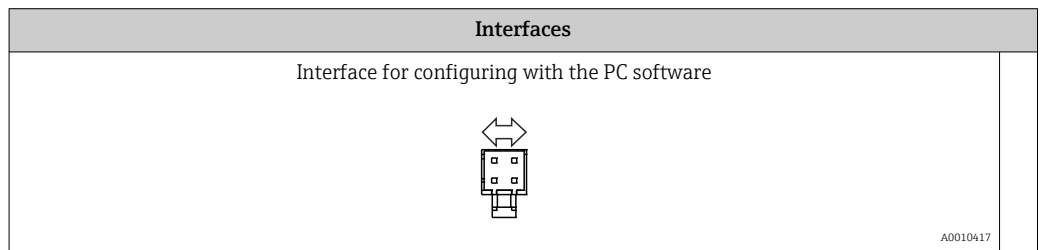
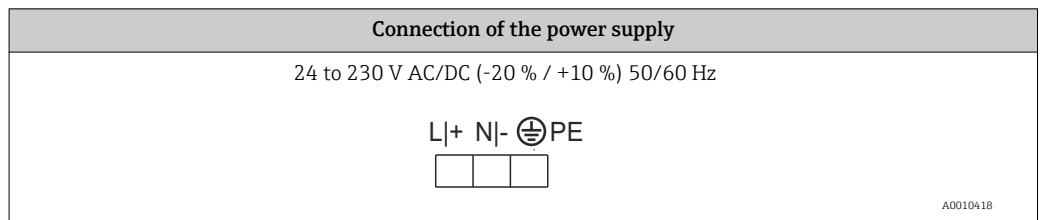
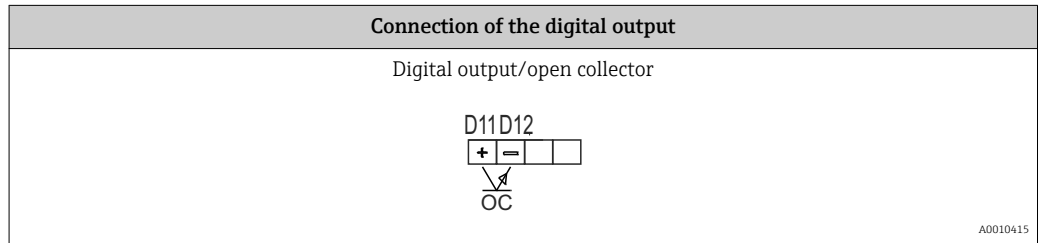
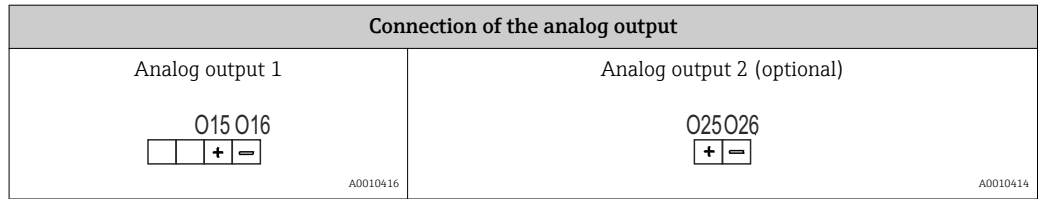

5.2 Post-connection check

Device condition and specifications	Notes
Are the device or cables damaged?	Visual inspection
Electrical connection	Notes
Does the supply voltage match the specifications on the nameplate?	24 to 230 V AC/DC (-20 % / +10 %) 50/60 Hz
Are the power supply terminals firmly engaged in their correct slot?	-
Are the mounted cables strain-relieved?	-
Are the supply voltage and signal cables connected correctly?	See connection diagram on the housing.

6 Operation

The easy operating concept of the device makes it possible for users to commission the device for many applications without a printed set of Operating Instructions.



The FieldCare operating software is a quick and convenient way of configuring the device. Brief explanatory (help) texts provide additional information on individual parameters.

6.1 Operating elements

6.1.1 Local operation at the device

The device is operated by means of the three keys integrated in the front part of the device



	<ul style="list-style-type: none"> ▪ Open the configuration menu ▪ Confirm an entry ▪ Select a parameter or submenu offered in the menu
	<p>Within the configuration menu:</p> <ul style="list-style-type: none"> ▪ Scroll step-by-step through the parameters/menu items/characters offered ▪ Change the value of the selected parameter (increase or decrease) <p>Outside the configuration menu:</p> <p>Display enabled and calculated channels, as well as min. and max. values for all the active channels.</p>

You can always exit items/submenus at the end of the menu by selecting "x Back".

Leave the setup directly without saving the changes by pressing the '-' and '+' keys simultaneously for > 3 s.

6.1.2 Configuration via interface & FieldCare Device Setup PC configuration software

CAUTION

Undefined switching of outputs and relays possible while configuring with FieldCare

- ▶ Do not configure during running process.

To configure the device with the FieldCare Device Setup software, connect the device to your PC. You need a special interface adapter for this purpose, e.g. the Commubox FXA291.

Installing the communication DTM in FieldCare

Before the configuration of the device can be done, FieldCare Device Setup must be installed on your PC. The installation instructions can be found in the FieldCare instructions.

Subsequently, install the FieldCare device driver according to the following instructions:

1. Firstly, install the device driver "CDI DTMLibrary" in FieldCare. It can be found under "Endress+Hauser Device DTMs → Service / Specific → CDI" in FieldCare.
2. Then the DTM catalog must be updated. Add the new installed DTMs to the DTM catalog.

Installing the Windows driver for the TXU10/FXA291

To install the Windows driver Administrator rights are required. Proceed as follows:

1. Connect the device to the PC using the TXU10/FXA291 interface adapter.
 - ↳ A new device is detected and the Windows installation assistant opens.
2. In the installation assistant, do not carry out the automatic search for a driver. For this, choose "No, not this time" and click "Next".
3. In the subsequent window, choose "Install from a list or specific location" and click "Next".
4. In the next window, click "Browse" and select the directory where the driver for the TXU10/FXA291 adapter is located.
 - ↳ The driver is installed.
5. Finish the installation by clicking "Finish".
6. A further device is detected and the Windows installation assistant opens once more. Again, choose "No, not this time" and click "Next".
7. In the subsequent window, choose "Install from a list or specific location" and click "Next".
8. In the next window, click "Browse" and select the directory where the driver for the TXU10/FXA291 adapter is located.
 - ↳ The driver is installed.
9. Finish the installation by clicking "Finish".

The installation of the Windows driver for the interface adapter is now complete. Which COM-Port has been assigned for the adapter can be seen in the Windows device manager.

Establishing the connection

To establish the connection with FieldCare, proceed as follows:

1. Firstly, edit the connection macro. For this, start a new project and in the window displayed, click with the right mouse button on the symbol for "Service (CDI) FXA291" and choose "Edit".
2. In the following window, next to "Serial interface", select the COM port which has been assigned during the installation of the Windows driver for the TXU10/FXA291 adapter.
 - ↳ The macro is now configured. Complete configuration by clicking "Finish".
3. Start the macro "Service (CDI) FXA291" by double-clicking it and confirm the subsequent query with "Yes".
 - ↳ A connected device is searched and the suitable DTM is automatically opened. The configuration starts.

To then configure the device itself, follow these Operating Instructions for the device. The entire Setup menu, i.e. all the parameters listed in these Operating Instructions, can also be found in the FieldCare Device Setup.

 In general, it is possible to overwrite parameters with the FieldCare PC software and the appropriate device DTM even if access protection is active.

If access protection by means of a code should be extended to the software, this function should be activated in the extended device setup.

For this purpose, select: Menu → Setup / Expert → System → Overfill protect → German WHG and confirm.

6.2 Display and device status indicator/LED

The device provides an illuminated LC display which is split into two sections. The segment section displays the value of the channel and additional information and alarms.

In the dot matrix section, additional channel information, such as the TAG, unit or bar graph, is displayed in the display mode. Operating text in English is displayed here during operation.

The parameters for configuring the display are explained in detail in Section "Configuring the device".

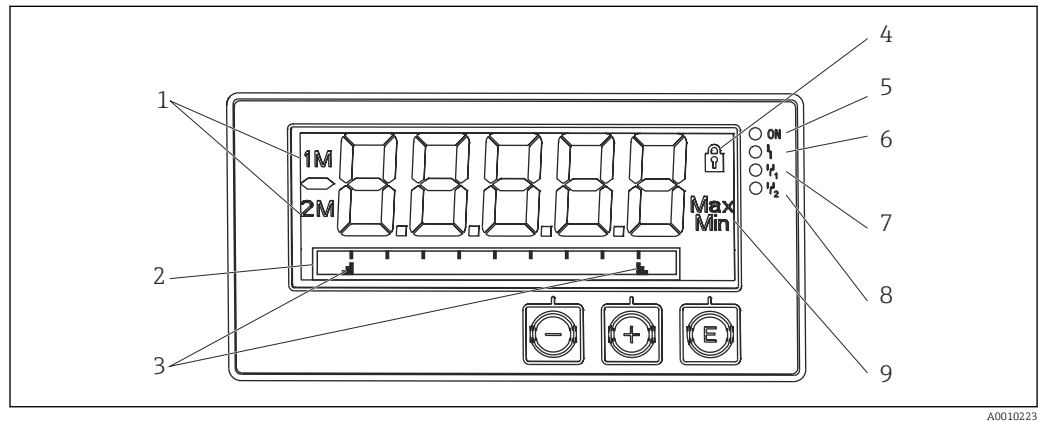

4 Display of the device

- 1 Channel display: 1: analog input 1; 2: analog input 2; 1M: calculated value 1; 2M: calculated value 2
- 2 Dot matrix display for TAG, bar graph and unit
- 3 Limit value indicators in the bar graph
- 4 "Operation locked" indicator
- 5 Green LED; on - supply voltage applied
- 6 Red LED; on - error/alarm
- 7 Yellow LED; on - relay 1 energized
- 8 Yellow LED; on - relay 2 energized
- 9 Minimum/maximum value indicator

In the event of an error, the device switches automatically between displaying the error and displaying the channel, → 35 and → 40.

6.3 Icons

6.3.1 Display icons

	Device is locked/operating lock; the device setup is locked against changes to parameters, the display can be modified.
1	Channel one (Analog in 1)
2	Channel two (Analog in 2)
1M	First calculated value (Calc value 1)
2M	Second calculated value (Calc value 2)
Max	Maximum value/value of the maximum indicator of the channel displayed
Min	Minimum value/value of the minimum indicator of the channel displayed

In the event of an error:

The display shows: -----, the measured value is not displayed

Underrange/overrange: - - - - -

 In the dot matrix section, the error and channel name (TAG) are specified.









6.3.2 Icons in the editing mode

The following characters can be used to enter user-defined text:

'0-9', 'a-z', 'A-Z', '+', '-', '*', '/', '\', '%', '°', '2', '3', 'm', '.', ',', ';', ':', '!', '?', '_', '#', '\$', '@', ' ', '(', ')', '~'













For numerical entries, the numbers '0-9' and the decimal point are available.

Furthermore, the following icons are used in the editing mode:

	Symbol for the setup
	Symbol for the Expert setup
	Symbol for diagnostics
	Accept entry. If this icon is selected, the information entered is accepted at the position and the user exits the editing mode.
	Reject entry. If this icon is selected, the information entered is rejected and the user exits the editing mode. The text configured beforehand remains unchanged.
	Move one position to the left. If this icon is selected, the cursor moves one position to the left.
	Delete back. If this icon is selected, the character to the left of the cursor is deleted.
	Delete all. If this icon is selected, all the information entered is deleted.

6.4 Quick guide to the operating matrix

The following tables show all menus and the operating functions.

Display menu	Description
 AI1 Reset minmax*	Reset the min/max values for Analog in 1
 AI2 Reset minmax*	Reset the min/max values for Analog in 2
 CV1 Reset minmax*	Reset the min/max values for Calc value 1
 CV2 Reset minmax*	Reset the min/max values for Calc value 2
 Analog in 1	Display setting for Analog in 1
 Analog in 2	Display setting for Analog in 2
 Calc value 1	Display setting for Calc value 1
 Calc value 2	Display setting for Calc value 2
 Contrast	Display contrast
 Brightness	Display brightness
 Alternating time	Switchover time between values chosen to be displayed
 Back	Return to main menu

*) Is only displayed if "Allow reset" = "Yes" is set in the "Expert" menu for the corresponding channel.

Setup menu		Description
⊞	Application	Application selection
	1-channel	1-channel application
	2-channel	2-channel application
	Diff-pressure	Difference pressure application
⊞	AI1 Lower range*	Lower measuring range limit for Analog in 1
⊞	AI1 Upper range*	Upper measuring range limit for Analog in 1
⊞	AI2 Lower range*	Lower measuring range limit for Analog in 2
⊞	AI2 Upper range*	Upper measuring range limit for Analog in 2
⊞	CV Factor*	Factor for calculated value
⊞	CV Unit*	Unit for calculated value
⊞	CV Bar 0%*	Lower limit for bargraph of calculated value
⊞	CV Bar 100%*	Upper limit for bargraph of calculated value
⊞	Linearization*	Linearization of calculated value
	No lin points	Number of linearization points
	X-value	X-values for linearization points
	Y-value	Y-values for linearization points
⊞	Analog in 1	Analog input 1
	Signal type	Signal type
	Signal range	Signal range
	Connection	Connection type (only for Signal type = RTD)
	Lower range	Lower limit of measuring range
	Upper range	Upper limit of measuring range
	Tag	Designation of analog input
	Unit	Unit of analog input
	Temperature unit	Unit for temperature; only visible is "Signal type" = RTD or TC
	Offset	Offset of analog input
	Ref junction	Reference junction (only for Signal type = TC)
	Reset min/max	Reset min/max value for analog input
⊞	Analog in 2	Analog input 2
	see Analog in 1	
⊞	Calc value 1	Calculated value 1
	Calculation	Type of calculation
	Tag	Designation of calculated value
	Unit	Unit of calculated value
	Bar 0%	Lower limit for bargraph of calculated value
	Bar 100%	Upper limit for bargrapg of calculated value
	Factor	Factor for calculated value
	Offset	Offset for calculated value
	No lin points	Number of linearization points
	X-value	X-values for linearization points
	Y-value	Y-values for linearization points

*) Is only displayed if "Application" = "Diff pressure" is configured.

Setup menu		Description
	Reset min/max	Reset min/max values
	Calc value 2	Calculated value 2
	See Calc value 1	
+	Analog out 1	Analog output 1
	Assignment	Assignment for analog output
	Signal type	Signal type of analog output
	Lower range	Lower range limit of analog output
	Upper range	Upper range limit of analog output
+	Analog out 2	Analog output 2
	See Analog out 1	
+	Relay 1	Relay 1
	Assignment	Assignment of value to be monitored with relay
	Function	Operating function for relay
	Set point	Set point for relay
	Set point 1/2	Set points 1 and 2 for relay (only, if Function = Inband, Outband)
	Time base	Time base for gradient evaluation (only, if Function = Gradient)
	Hysteresis	Hysteresis for relay
+	Relay 2	Relay 2
	See Relay 1	
+	Back	Return to main menu

*) Is only displayed if "Application" = "Diff pressure" is configured.

Diagnostics menu		Description
E	Current diagn	Current diagnostic
+	Last diagn	Last diagnostic
+	Operating time	Operating time of the device
+	Diagnost logbook	Diagnostics logbook
+	Device information	Device information
+	Back	Return to main menu



Expert menu		Description
E	Direct access	Direct access to an operating function
+	System	System settings
	Access code	Protection of operating menu by means of access code
	Overfill protect	Overfill protection
	Reset	Device reset
	Save user setup	Save settings made in the setup
+	Input	Inputs
	The following parameters are available in addition to the parameters from the Setup menu:	
	Analog in 1 / 2	Analog input 1 / 2
	Bar 0%	Lower limit for bargraph of analog input

Expert menu		Description
	Bar 100%	Upper limit for bargraph of analog input
	Decimal places	Decimal place for analog input
	Damping	Damping
	Failure mode	Failure mode
	Fixed fail value	Fixed value in the event of an error (only, if Failure mode = Fixed value)
	Namur NE43	Error limits according Namur
	Allow reset	Allow reset of min/max values via Display menu
+	Output	Outputs
The following parameters are available in addition to the parameters from the Setup menu:		
	Analog out 1 / 2	Analog output 1 / 2
	Fail mode	Failure mode
	Fixed fail value	Fixed value in the event of an error (only, if Fail mode = Fixed value)
	Relay 1 / 2	Relay 1/2
	Time delay	Switching delay time
	Operating mode	Operating mode
	Failure mode	Behavior in the event of an error

7 Commissioning

7.1 Post-installation check and switching on the device

Make sure that all post-connection checks have been carried out before you commission your device:

- 'Post-installation check' checklist →  10
- 'Post-connection check' checklist →  13

Once the operating voltage is applied, the display lights up and the green LED indicates that the device is operational.

When you commission the device for the first time, you program the setup in accordance with the descriptions provided in these Operating Instructions in the following sections.

When commissioning a device already configured or preset, measuring is immediately started as per the settings. The values of the channels currently activated appear on the display. Changes to the display can be made in the Display menu item →  31.

 Remove the protective foil from the display as this restricts display legibility otherwise.

7.2 General information on the device configuration

You can commission/configure your device locally using the three integrated keys, or by PC. You require the Commubox FXA291 to connect the device to a PC (see 'Accessories' section).

Advantages of configuring the device using FieldCare Device Setup:

- The device data are saved in the FieldCare Device Setup and can be called up at any time.
- Entries can be made more quickly using the keyboard.

7.3 Notes on setup access protection

Access to the setup is enabled when the device leaves the factory. Access can be locked via the setup.

Proceed as follows to lock the device:







1. Press **E** to get to the configuration menu.
2. Press **+**, **Setup** is displayed.
3. Press **E** to open the **Setup** menu.
4. Press **+** again until **System** is displayed.
5. Press **E** to open the **System** menu.
6. **Access code** is displayed.
7. Press **E** to open the configuration of the access protection.
8. Set the code: the desired numerical value is configured by pressing the **+** and **-** keys. The access code is a four-digit number. The corresponding position of the number is displayed in plain text. To confirm the value entered and to go to the next position, press **E**.



9. Confirm the last position of the code to exit the menu. The code is displayed in full. Press **+** to scroll to the last point of the submenu **x Back** and confirm this point. As a result, the value is accepted and the user returns to the level of the **Setup** menu. Also exit this submenu via the last **x Back** parameter to get back to the measured value/channel display.

 The **x Back** point can be found at the end of every picklist/menu item. If you confirm this parameter, you go from the submenu to the higher-order menu, or you exit the setup.

7.4 Configuring the device

Configuration steps:

1. Select the application conditions (only for 2-channel devices) →  22
2. Configure the universal input(s) →  24
3. Configure the calculations →  25
4. Configure the analog output(s) →  26
5. Configure relays (if option selected); assign and monitor limit values →  26
6. Advanced device configuration (access protection/operating code; saving the current setup/user setup) →  30
7. Configure the display functions →  31

The following section provides a detailed account of how to set up the two-channel device and the differential pressure application package (brief overview of the configuration →  23, only available in the two-channel version). If you want to configure a singlechannel device, please proceed as explained in Step 2 →  24.

7.4.1 Step 1: Selecting the application conditions/number of active input channels

Application conditions of a two-channel device

Call up the Setup menu after performing the post-installation check.

Press **E** → press **+** → **Setup** is displayed, press → **E**.

Select your application conditions in the first point of the setup. The following options are available:

- Differential pressure (Diff pressure): application package; parameters are automatically preconfigured for you.
- Single channel (1-channel): universal input 2 (Analog in 2) is deactivated (off) from the software side. The second channel can always be activated at a later stage via **Setup** → **Analog in 2** →  24.
- Two channels (2-channel): universal input 1 (Analog in 1) and universal input 2 (Analog in 2) are preconfigured with the following values:
 - Signal type (Signal type): **Current**
 - Signal range (Signal range): **4-20mA**

The following section provides a detailed description of the "Differential pressure" application package.

To set up the device in single-channel/two-channel applications, please proceed with the device setup as explained in Step 2 →  24.

 If the application or the parameter selected are subsequently changed, parameters already configured are retained (e.g. if the differential pressure application is changed to two-channel: **Calc value 1** remains at the Difference parameter).

Differential pressure application

A concise setup is available for differential pressure applications.

Once the differential pressure application setup has been successfully completed, the configured parameters of the analog inputs and the linearization points are used to automatically form the difference between the two inputs and linearize the signal. As a result, the volume is already shown on the display (= calculated value 2).

i The following is essential to ensure values are calculated correctly and that the setup functions properly:

- Sensor 1 returning the higher pressure: connected to analog input 1 (Analog in 1)
- Sensor 2 returning the lower pressure: connected to analog input 2 (Analog in 2)

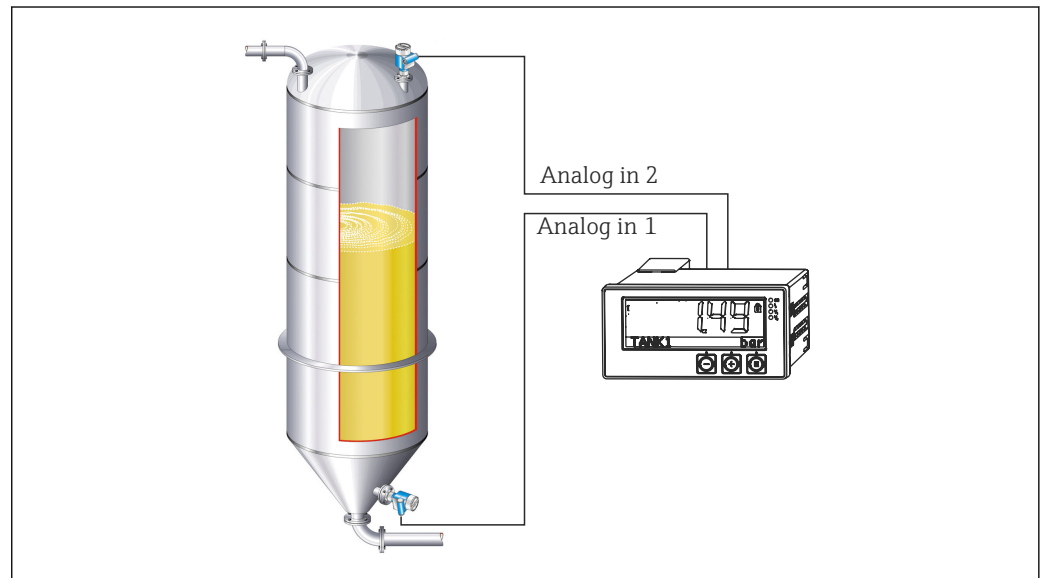

A0010350

5 Differential pressure application

Setup → Application → Diff pressure

After selecting the differential pressure application by confirming the **Diff pressure** parameter, the parameters, which are displayed in succession and can be edited, must be configured individually for your application.

Some parameters are already configured for you by selecting the application setup → **24**.





The parameter **CV Factor** serves for the regard of the density of the medium at level measurement, i.e. it equates the mathematic formula $1/(\text{density} \cdot \text{gravitational acceleration})$. The standard value of the factor is 1.

At this the density is to be named in kg/m^3 and the pressure in Pascal (Pa) or N/m^2 . The gravitational acceleration is defined by the constant on the earth's surface.

It amounts $g=9.81 \text{ m/s}^2$. Tables and examples for the conversion of application related units into the defined values kg/m^3 and Pa respectively N/m^2 can be found in the appendix → **54**.



i If you want to activate other parameters (see Step 4, 5, 6 and 7 or offset for analog inputs, display original values of analog channels, etc.), you can do so afterwards in the setup of the corresponding parameter.

‘Setup’ menu item

Setup → Application → ‘Diff pressure’	
Preconfigured by application package	Submenu
Setup analog inputs Signal: Current Range: 4-20 mA →  22 and →  24	AI1 Lower range: start of measuring range, analog input 1 (corresponds to 4 mA for example)
	AI1 Upper range: end of measuring range, analog input 1 (corresponds to 20 mA for example)
	AI2 Lower range: start of measuring range, analog input 2 (corresponds to 4 mA for example)
	AI2 Upper range: end of measuring range, analog input 2 (corresponds to 20 mA for example)
Setup display Display: calculated value and bar graph for Calc Value 2: Active; all other values inactive →  31	CV Unit: unit of the calculated volume value (e.g.liters)
	CV Bar 0%: start of measuring range for bar graph display
	CV Bar 100%: end of measuring range for bar graph display
CV Factor	CV Factor: Factor for the regard of the density of the medium at level measurement, i.e. it equates the formula $1 / (\text{density} * \text{gravitational acceleration})$; Standard value: 1
Setup calculation of the volume: Calc value 1: Difference Calc value 2: Lineariz. CV1 →  25	Create the linearization table: If the volume value should be calculated - i.e. a linearization of the difference is output - the X and Y coordinates have to be specified as the basis for performing the calculation.
	No lin points: number of linearization points required (max. 32)
	X-value: X-coordinate for linearization point X1, 2, ...
	Y-value: Y-coordinate for linearization point X1, 2, ...
	End differential pressure setup

7.4.2 Step 2: Configuring the universal input(s) (‘AnalogIn 1/2’)

The device has one universal input, and optionally another universal input for current (Current), voltage (Voltage), resistance thermometer (RTD) or thermocouples (TC).

(‘Current’), voltage (‘Voltage’), resistance thermometer (‘RTD’) or thermocouples (‘TC’). The input is monitored for a cable open circuit (see "Measuring range limits" table →  36 and "Troubleshooting" section →  40).

Minimum/maximum values at the inputs:

 The current min./max. value is saved every 15 minutes. If the power supply is disconnected (mains off/mains on), a gap in the recording may result. The measuring interval starts when the device is switched on. It is not possible to synchronize the measuring cycles to full hours.

Limit values and relays are available for monitoring the measured values. They should be configured as described in Step 5 →  26.

Each universal input saves the smallest and biggest measured value measured. These values can be reset individually for every channel. In the setup, the administrator can decide whether a user can reset the minimum and maximum values of the individual channels directly in the main menu without the need for a release code. It is reset in the event of a Reset and if the scaling of the channel is changed.

Setup
Analog in 1 Analog in 2

Current	Voltage	RTD (resistance thermometer)	TC (thermocouple)	Off (Deactivate the input)
Signal range Signal range (see Technical data); start and end of measuring range defined by type selected				
Lower range Start of measuring range; also enter decimal point		Connection (only RTD) Type of connection (2-, 3-, 4- wire connection)		
Upper range End of measuring range; also enter decimal point				
TAG Channel identifier				
Unit Unit				
Offset Constant value that is added to the current measured value				
Ref junction (TC only) intern / fixed + entering "Fixed ref junc" value				
Res minmax: (yes/no) Reset minimum/maximum values?				

7.4.3 Step 3: Configuring the calculations

One or two channels with the following functions are available for calculations:

Setup	
Calc value 1	Calc value 2
<ul style="list-style-type: none"> ▪ Switched off ▪ Sum (AI1+AI2) ▪ Difference (AI1-AI2) ▪ Average ((AI1+AI2)/2) ▪ Linearization AI1 ▪ Multiplication (AI1*AI2) 	<ul style="list-style-type: none"> ▪ Switched off ▪ Sum (AI1+AI2) ▪ Difference (AI1-AI2) ▪ Average ((AI1+AI2)/2) ▪ Linearization AI2 ▪ Linearization CV1 ▪ Multiplication (AI1*AI2)
TAG Unit Bar 0% Bar 100% Factor Offset	To be configured like universal input, see Step 2 → 24
No. lin points → X/Y coordinates The device has two linearization tables, each with a maximum of 32 linearization points. They are permanently assigned to the 'Calc value 1' and 'Calc value 2' channels. If linearization is selected as the calculation, the number of linearization points needed is specified in the 'No. lin points' parameter. An X-coordinate and a Y-coordinate has to be specified for each linearization point. The linearization tables can be deactivated individually.	
Reset min/max	To be configured like universal input, see Step 2 → 24

7.4.4 Step 4: Configuring the analog output(s)

The device is fitted with an analog output (optionally with two analog outputs). These outputs can be freely assigned to the inputs and channels available in the device.

Setup	
Analog out 1 Analog out 2	
Assignment: assignment of the output <ul style="list-style-type: none"> ▪ off: switched off ▪ Analog input 1: universal input 1 ▪ Analog input 2: universal input 2 ▪ Calc value 1: calculated value 1 ▪ Calc value 2: calculated value 2 	
Signal type: select active signal range of the output	The output range for the current output corresponds to Namur NE43, i.e. a range to 3.8 mA or 20.5 mA is used. If the value continues to increase (or if it continues to drop), the current remains at the limits 3.8 mA or 20.5 mA. 0-20 mA output: only the overrange is available. An overrange is also only available for the voltage output. The limit of the overrange is 10% here.
Lower range Upper range	To be configured like universal input, see Step 2 → 24

7.4.5 Step 5: Configuring the relays, assigning and monitoring limit values

As an option, the device has two relays with limit values, which are either switched off, or can be assigned to the input signal or the linearized value of analog input 1 or 2 or the calculated values. The limit value is entered as a numerical value including the position of the decimal point. Limit values are always assigned to a relay. Each relay can be assigned to a channel or a calculated value. In the "Error" mode, the relay functions as a fault indicator relay and switches for every fault or alarm.

The following settings can be made for each of the two limit values: assignment, function, set point, hysteresis, operating mode¹⁾, time delay¹⁾ and failure mode¹⁾.

Setup	
Relay 1 Relay 2	
Assignment: Which value should be monitored?	off , Analog input 1, Analog input 2, Calc value 1, Calc value 2, Error
Function: Operating mode of the relay (for a description, see "Operating modes") → 27)	Min, Max, Gradient, out-band, in-band
Set point: Set point 2: Limit value	Enter the limit value with the position of the decimal point. Set point 2 is only displayed for outband and inband.

1) can only be set in the menu Expert/Output/Relay

Time base: Time base of gradient calculation	Enter the time base in seconds. Only for operating mode Gradient.
Hysteresis: Hysteresis. The switch point can be controlled by means of a hysteresis for every limit value.	The hysteresis is configured as an absolute value (only positive values) in the unit of the channel in question (e.g. upper limit value = 100 m, hysteresis = 1 m: limit value on = 100 m, limit value off = 99 m)

-  Please note special situations if both the hysteresis and the delay time should be activated simultaneously (see the following description in the Operating modes section).
- Following a power failure, the limit value monitoring system behaves as if the limit value had not been active before the power failure, i.e. the hysteresis and any delay are reset.

Relay specification

Relay contact	Changeover
Maximum contact burden DC	30 V / 3 A (permanent state, without destruction of the input)
Maximum contact burden AC	250 V / 3 A (permanent state, without destruction of the input)
Minimum contact load	500 mW (12 V / 10 mA)
Galvanic isolation towards all other circuits	Test voltage 1 500 V _{AC}
Switching cycles	> 1 million
Default setting	Normally closed: Rest contact Rx1/Rx2

Operating modes

Off

No action is triggered. The output assigned is always in the normal operating mode.

Min (lower limit value)

The limit value is active if the value configured is undershot. The limit value is switched off again if the limit value incl. hysteresis is overshoot.

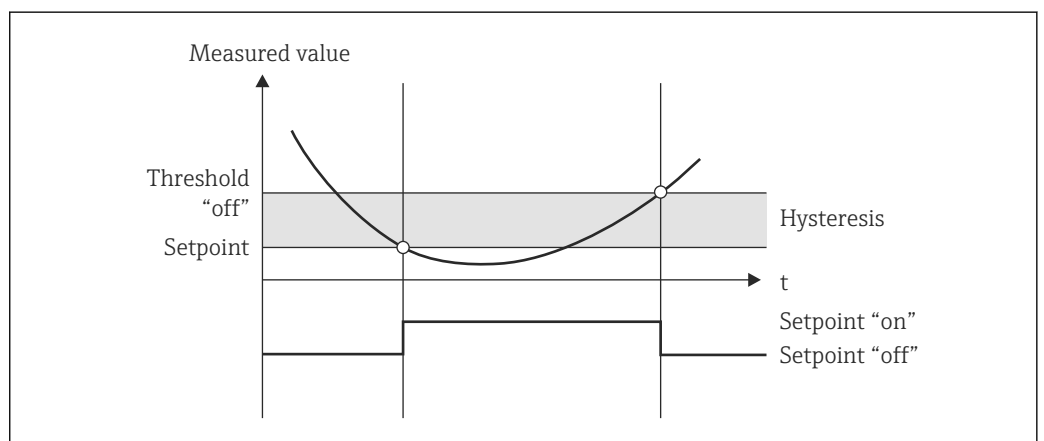

 6 *Min operating mode*

A0010186-EN

Max (upper limit value)

The limit value is active if the value configured is overshoot. The limit value is switched off again if the limit value incl. hysteresis is undershot.

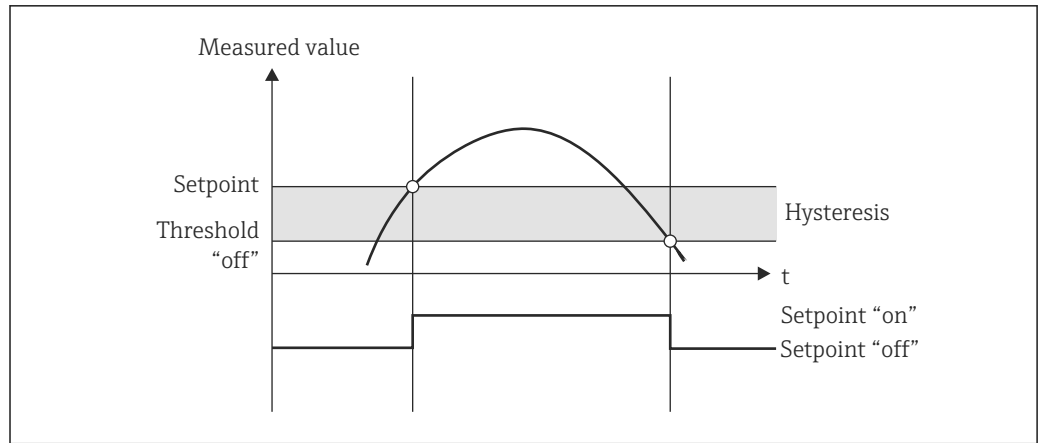

A0010187-EN

7 Max operating mode

Gradient

The "Gradient" operating mode is used to monitor the change in the input signal over time. The alarm is triggered if the measured value reaches or overshoots the set value. If the user configures a positive value, the limit value is monitored for rising gradients.

For negative values, the falling gradient is monitored.

The alarm ends if the gradient drops below the set value again. A hysteresis is not possible for the Gradient operating mode. The alarm can be damped by means of the delay time function (second (s) unit) to reduce the sensitivity.

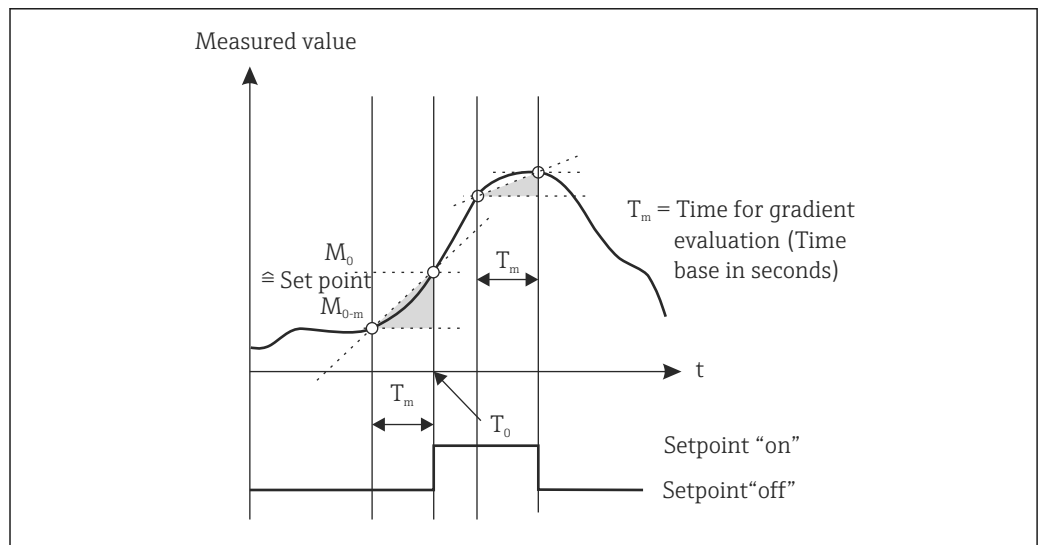

A0010188-EN

8 Gradient operating mode

OutBand

The limit value is violated as soon as the measured value to be checked drifts into a band specified beforehand by minimum and maximum values. The hysteresis is located at the outsides of the band.

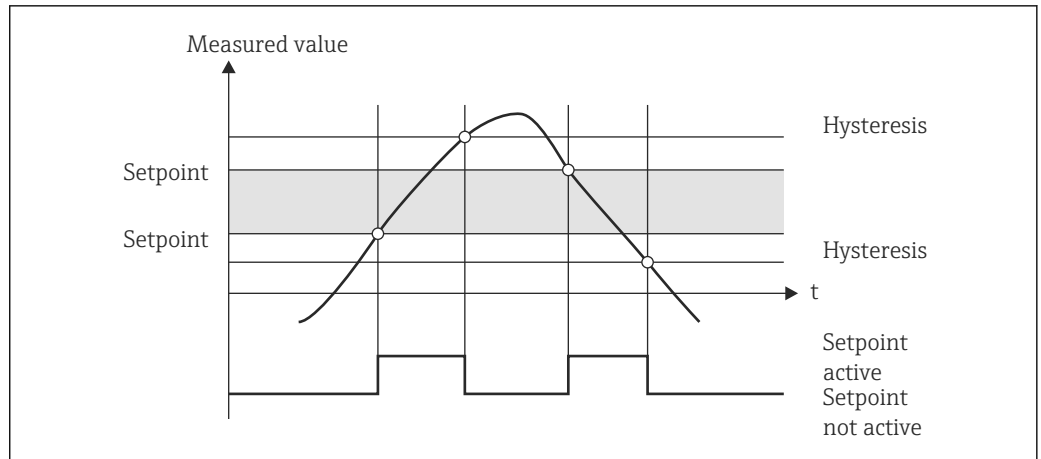

9 Outband operating mode

InBand

The limit value is violated as soon as the measured value to be checked drops below or exceeds a minimum or maximum value specified beforehand. The hysteresis is located at the insides of the band.

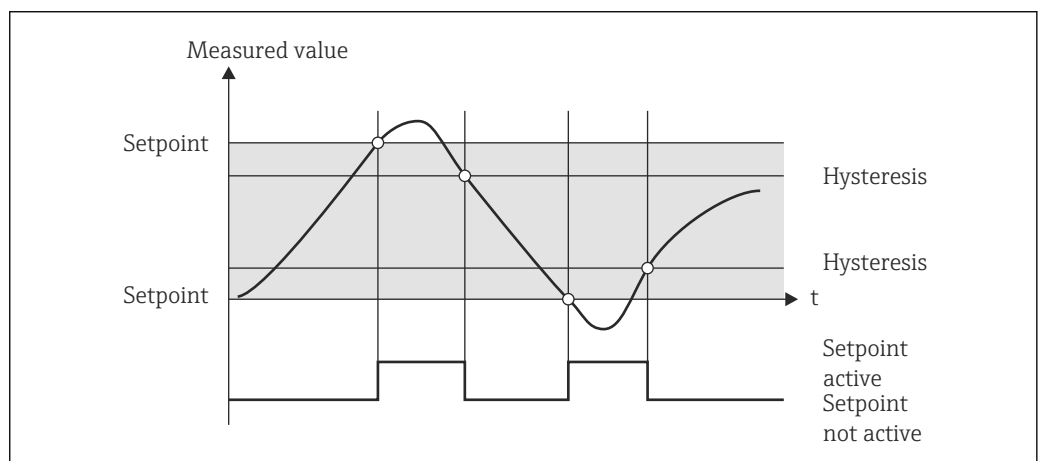

10 Inband operating mode

Special situation: hysteresis and delay at one limit value

In special cases when the hysteresis and limit value display are activated, a limit value is switched based on the following principle.

If the hysteresis and limit value delay are activated, the delay is activated when a limit value is overshoot and measures the time since the value overshoot began. If the measured value drops back below the limit value, the delay is reset again. This also happens if the measured value falls under the limit value but is still above the specified value of the hysteresis. The next time the limit value is exceeded, the delay time becomes active and starts measuring from 0.

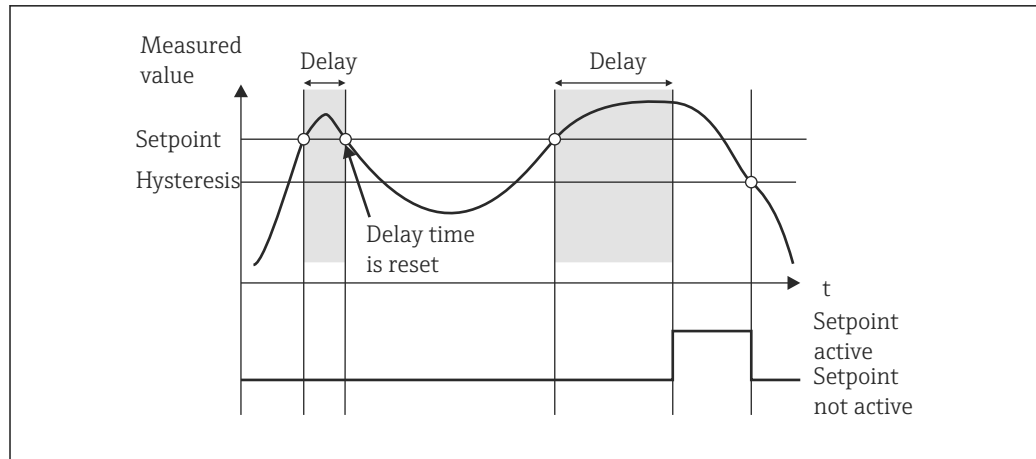

11 Hysteresis and delay active

7.4.6 Step 6: Advanced device configuration (access protection/operating code, saving the current setup)

Access protection

The access protection locks all the editable parameters, i.e. setup can only be accessed once the 4-digit user code has been entered.

Access protection is not activated at the factory. However, the configuration of the device can be protected by a four-digit code.

Activating access protection:

1. Call up the menu 'Setup' → 'System' → 'Access code'
2. To enter the code with the '+' and '-' keys, select the desired character and confirm with 'E'. The cursor goes to the next position.
 - ↳ Once the fourth position has been confirmed, the entry is accepted and the user exits the 'Access code' submenu.

Once access protection has been successfully activated, the lock symbol is shown on the display.

i If access protection is enabled, the device locks automatically after 600 seconds if it has not been operated in this time. The display switches back to the operating display. To delete the code completely, use the '+' and '-' keys to select the "c" character and confirm with 'E'.

Saving the current setup/user setup

The current configuration of the device can be saved and is thus available as a specific setup for a device reset or for a device restart. If you ordered the device with customized settings which you specified, the preconfigured setup is also saved in the user setup.

Saving the setup:

1. Call up the menu 'Expert' → 'System' → 'Save User Setup'.
2. Confirm by configuring 'Yes'.

i See also device reset → 37.

7.4.7 Step 7: Configuring the display functions

The display is split into a 7-segment display section and a color section. The dot matrix section can be configured separately for each channel.

All the active channels (analog inputs and calculated values) are offered for selection.

To configure the display

1. Press 'E'
2. Select 'Display'
3. Select → channel / calculated value and configure one of the following parameters.

off	Channel is not displayed.	
Activate the display by configuring the color section:		
	Value/measured value of the channel is displayed on the 7-segment display.	
	Unit	The unit of the channel is displayed
	Bargraph	The value of the channel is displayed as a bar graph over the entire width.
	Bargr+unit	Division of the color section, displays value of the channel as a bar graph and unit of the channel
	TAG+unit	Division of the color section, displays channel name and unit of the channel

- **Contrast:** select contrast (can be configured in stages 1 to 7)
- **Brightness:** select brightness (can be configured in stages 1 to 7)
- **Alternating time:** select the time between automatic switchover between the channels and calculated values (in seconds: 3, 5, or 10)
- **x Back** takes you back to the higher-order menu.

 If several channels are active, the device switches automatically between the channels configured.

Non-activated channels, calculated values and minimum and maximum values are called up manually by pressing the '+' and '-' keys and appear for 5 seconds on the display.

7.4.8 Overfill protection

In accordance with Annex 2, Section 2(3) and Section 4 of TRbF 510 (Regulation/ construction and inspection guidelines for overfill protection units), and in accordance with the approval guidelines for overfill protection units (ZG-ÜS), the device can be used as a limit signal transmitter for overfill protection units with continuous level measurement for storing combustible and noncombustible liquids which are hazardous to water.

Reason:

The device meets the requirement that plant units without an inspection label have to comply with the general and special construction and inspection principles for overfill protection in accordance with Annex 2, Section 4, in the following situations:

- in the event of power supply failure and
- if limit values are overshoot or undershot and
- if the connection wires between the upstream isolating transmitter and the meter are disconnected, the safety-oriented message "Maximum level" appears (the limit relay deenergizes).

The set limit values for overflow protection must be protected against unintentional modification.

i The following function must be activated if additional access protection should be provided for the configuration software:

Select Setup / Expert → System → Overflow protect: German WHG.

Configuration when operating the device in accordance with TRbF510:

The device must be set up and operated in accordance with these Operating Instructions which belong to the device.

- Universal inputs have to be configured (as described in Step 1 - Step 3 → 22).
- Limit values have to be configured as follows (as described in Step 5 → 26):

Function: MAX

Assignment: which input signal should be monitored?

Set point: maximum limit value to be monitored; value for the switching threshold

Hysteresis: no hysteresis (=0)

Time delay¹⁾: no switching delay (=0) or the set time must be taken into account for the tail quantity

- The device must be locked against access from non-authorized persons;

User Code protects the parameters configured (as Step 6 → 30):

Enter the 4-digit code: select digit with '+' or '-' and confirm the individual digit with 'E'; once the digit has been confirmed, the cursor moves to the next position, or skips back to the 'System' menu item once the fourth digit has been entered

The lock symbol appears on the display.

- Select **Setup → System → Overflow protect:** German WHG.

It is absolutely essential to assign the device to a WHG application. Confirming the 'Overflow protect: German WHG' parameter provides additional safety. The device status has to be changed if configuring the device by means of the FieldCare operating software, i.e. WHG must be disabled to be able to change parameters.

1) Only in the Expert menu.

7.4.9 Expert menu

You activate the Expert mode by pressing **E → Expert**.

The Expert menu offers advanced device settings to be able to adapt the device optimally to the application conditions.

An access code is needed to access the Expert menu. This code is preset at the factory as "0000". If a new access code is defined by the user, it replaces the access code assigned at the factory.

The Expert menu is enabled as soon as the correct access code has been entered.

The configuration options which the Expert mode also offers in addition to the parameters of the normal setup are explained in the following section.

Input → Analog input 1/2

Bar 0%, Bar 100%

Change the scaling of the bar graph; default value: channel scaling

Decimal places

Specify the desired number of decimal places; default value: 2 decimal places

Damping

The input signal can be damped by means of a low-pass filter.

The damping is specified in seconds (can be configured in steps of 0.1 s, max. 999.9 s).

Default values

Input type	Default value
Current and voltage inputs	0.0 s
Temperature inputs	1.0 s

Once 5 times the filter time have elapsed, 99% of the actual measured value is reached.

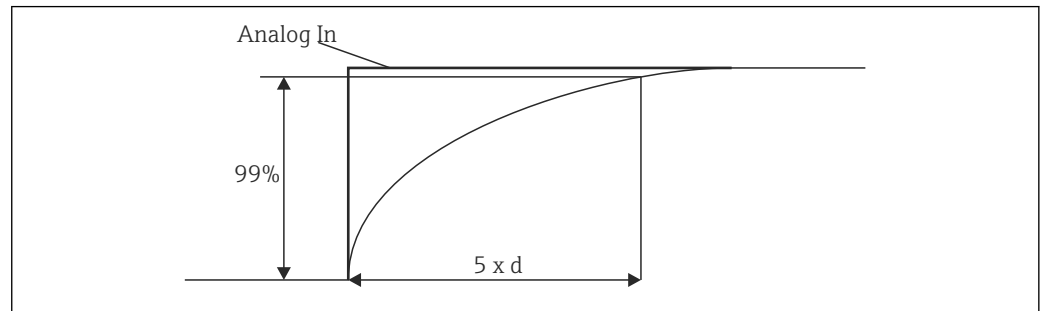

12 Signal damping

Analog In: analog input signal

d: set damping

Failure mode

If an error is detected at one of the two inputs, the internal status of the input is set to error. The behavior of the measured value in the event of an error can be defined here.

- Invalid = Ungültiger Wert:

The value is not calculated further since it is passed on as an invalid value.

- Fixed value = Konstanter Wert:

A constant value can be entered. This value is used if the device should perform further calculations. The input continues to be in a fault state. The error flag is also transmitted if the signal is processed further.

Namur NE43

Only for 4 to 20 mA. The measured value and the cables are monitored in accordance with NAMUR NE43 recommendations. See → 36 for this purpose. Default value: enabled

Open circ detect

Only for 1 to 5 V. Open circuit monitoring of the input.

Failure delay

Delay time for errors, 0 to 99 s

Allow reset

If this function is activated, the min. and/or max. values can be reset outside the setup in the Display menu. Active access protection does not lock resetting of this memory.

Output → Analog output 1/2*Failure mode*

- Min = Stored minimum value:
The stored minimum value is output.
- Max = Stored maximum value:
The stored maximum value is output.
- Fixed value = Constant value:
A constant value for output in the event of an error can be entered.

Output → Relay 1/2*Time delay*

Setting the time delay for relay switching.

Operating mode

Operating mode of the relay:

- norm opened
- norm closed

Failure mode

- norm opened
- norm closed

NOTICE**Setting the limit relay failsafe mode**

- ▶ The failsafe mode of the limit relay is configured in the setup. If an input to which a limit value is assigned experiences an error, the limit relay assumes the configured status. The effect of the limit relay in the event of an error must be specified in the setup (energizes or de-energizes). If a failsafe mode with a fixed error substitute value is configured in the input assigned, the corresponding relay does not react to the error at the input. Instead it checks the substitute value for limit value violation and switches depending on the limit value violation. The default value specifies that the relay is energized.

Application → Calc value 1/2*Failure mode*

- Invalid:
The calculated value is not valid and is not output.
- Fixed value:
A constant value for output in the event of an error can be entered.

Diagnostics*Verify HW set*

If the hardware has been upgraded (e.g. contains additional relays, universal inputs etc.), hardware verification has to be performed, i.e. the hardware is checked by the deviceinternal firmware.

The Verify HW set function has to be activated in such situations.

Simulation

The output value of the analog outputs and the switching condition of the relays can be specified in the simulation mode. Simulation remains active until it is set to "off". The start and end of the simulation are saved in the diagnostic events.

Expert → Diagnostics → Simulation:

- Select the output to be simulated with the simulation value
- Select the relay to be simulated with the status

7.5 In operation

7.5.1 '+' and '-' quick pick keys

You can use the '+' and '-' quick pick keys to switch through all the active channels (universal inputs and calculated values) in the display mode. The measured value or the calculated value is then displayed for 5 seconds. The channel name pertaining to the value displayed appears in the color section of the display. The maximum and minimum value are offered for each active channel.

You can exit a menu at any time by pressing the '+' and '-' keys simultaneously. Any changes made are rejected.

7.5.2 Min./max. memory



The device writes the highest and lowest values of the inputs and calculated values and saves them cyclically every 15 minutes in the nonvolatile memory.

Display:

Select the corresponding channel using the '+' and '-' quick pick keys.

Reset the min. and max. values:

Reset in the setup: select the channel (Analog in 1/2, Calc value 1/2), 'Reset min/max', min./max. values of the corresponding channel are reset.

 A reset outside the setup (resetting without a user code) is only possible if this was enabled for the channel in the setup (Allow reset, →  24). Press 'E' and select 'Display'. All the channels for which resetting outside the setup is permitted are displayed in succession. Select the corresponding channel and set to 'Yes'. The channel is reset.

7.5.3 Device self-diagnosis, failsafe mode and cable open circuit detection/measuring range limits

The device monitors its inputs for a cable open circuit, as well as its own internal functions by means of comprehensive monitoring mechanisms in the device software (e.g. cyclic memory test).

If the self-diagnosis of the device detects an error, the device reacts as follows:

- Open collector output switches
- Red LED lights up
- Relay switches (if active and assigned as a fault/alarm relay)
- Display goes to the error mode → color of channel affected changes to red and an error is displayed
- The unit switches automatically between the active channels and the error display

Troubleshooting instructions and a list of all the error messages can be found in Section Troubleshooting → 40.

Measuring range limits

Display							
Display	-----	-----	Measured value	-----	-----	-----	Special points to note
Status	F	F	Measured value displayed and processed	F	F	F	
Range		Underrange		Overrange		Invalid measured value	
0 to 20 mA			0 to 22 mA	> 22 mA		Not calibrated	Negative currents are not displayed or calculated (value remains at 0)
4 to 20 mA (without Namur)		≤ 2 mA	> 2 mA < 22 mA	≥ 22 mA		Not calibrated	
4 to 20 mA (as per Namur)	≤ 2 mA ¹⁾ 2 < x ≤ 3.6 mA ²⁾	> 3.6 mA... ≤ 3.8 mA	> 3.8 mA... < 20.5 mA	≥ 20.5 mA... < 21 mA	≥ 21 mA ²⁾	Not calibrated	As per NAMUR 43
+/- voltage ranges		< -110%	-110%...110%	> 110%		Not calibrated	
Voltage ranges as of 0 V		< -10%	-10%...110%	> 110%		Not calibrated	
	No further calculation/further calculation with fixed error value		Further calculation in math and as min./max.				
1 to 5 V voltage range with activated cable open circuit detection	≤ 0.8 V		1 to 5 V		≥ 5.2 V	Not calibrated	
Thermocouples	Below the lower range limit ²⁾		0 to 100%		Above the upper range limit ²⁾		Cable open circuit detection as of approx. 50 kΩ ¹⁾
Resistance	Below the lower range limit ¹⁾		0 to 100%		Above the upper range limit ¹⁾		
	No further calculation/further calculation with fixed error value		Further calculation in math and as min./max.	No further calculation/further calculation with fixed error value			

1) cable open circuit

2) error at sensor

7.5.4 Saving diagnostic events/alarms and errors

Diagnostic events such as alarms and fault conditions are saved in the device as soon as a new error occurs or the status of the device changes. The events saved are saved every 30 minutes to the nonvolatile device memory.

The device lists the following values in the 'Diagnostics' menu:

- Current device diagnosis
- Last device diagnosis
- Previous 5 diagnosis messages

List of error codes, see Troubleshooting →  40.

 Under certain conditions events saved over the past 30 minutes might be lost.

7.5.5 Operating hours counter

The device has an internal operating hours counter which also acts as the reference for diagnostic events.

The operating hours can be found in the 'Diagnostics' → 'Operating time' menu item. This information cannot be reset or changed.

7.5.6 Device reset

The following reset categories are available for a device reset.

'Expert' → 'System' → 'Reset' → 'Factory reset': reset all the parameters to the as-delivered state; all the configured parameters are overwritten.

 Any user code already defined is overwritten!!! When operation is locked by a user code, this is indicated by a lock symbol on the display.

'Expert' → 'System' → 'Reset' → 'User reset': parameters are loaded and configured in accordance with the user setup saved; configuration currently configured or factory settings are overwritten by the user setup.

 Any user code already defined is overwritten by the user code defined in the user setup!!! If no user code was saved in the user setup, the device is no longer locked. When operation is locked by a user code, this is indicated by a lock symbol on the display.

8 Maintenance

No special maintenance work is required on the device.

9 Accessories

Various accessories, which can be ordered with the device or subsequently from Endress+Hauser, are available for the device. Detailed information on the order code in question is available from your local Endress+Hauser sales center or on the product page of the Endress+Hauser website: www.endress.com.

9.1 Device-specific accessories

9.1.1 Miscellaneous

Extension relays

	Order no.
Relay card incl. terminals	RIA45X-RA

Extension to two-channel device

	Order no.
Multifunction input card for channel 2 incl. terminals, non-Ex	RIA45X-IA
Multifunction input card for channel 2 incl. terminals, Ex-version	RIA45X-IB

9.2 Communication-specific accessories

Designation
Interface cable
Commubox TXU10 incl. FieldCare Device Setup and DTM Library
Commubox FXA291 incl. FieldCare Device Setup and DTM Library

10 Troubleshooting

The following section provides you with an overview of possible causes of errors to provide you with an initial troubleshooting aid.

NOTICE

Device malfunction possible when retrofitting with untested hardware

- ▶ When upgrading/retrofitting the device with additional hardware at a later date (relay, additional universal input and additional analog output), an internal hardware test must be performed by the device software. To do so use the Verify HW set function in the Expert→Diagnostics menu.

10.1 Troubleshooting instructions

⚠ WARNING

Danger through electric tension

- ▶ The device cannot be operated in an open state for error diagnosis!

- i** Error codes that are shown on the display are described in the next section → 40. Further information on the failsafe mode is also provided in Section Commissioning → 35.

10.2 Process error messages

- i** Faults have the highest priority. The associated error code is displayed.

10.2.1 Device malfunction

The errors are defined as:

Error code	Meaning	Remedy
F041	Sensor/cable open circuit	Check wiring.
F045	Sensor error	Check sensor.
F101	Range undershoot	Check measurement, limit violated.
F102	Range overshoot	
F221	Error: comparison measurement point	Contact your local service organization.
F261	Error: flash	Contact your local service organization.
F261	Error: RAM	Contact your local service organization.
F261	Error: EEPROM	Contact your local service organization.
F261	Error: converter channel 1	Contact your local service organization.
F261	Error: converter channel 2	Contact your local service organization.
F261	Error: invalid device ID	Contact your local service organization.
F281	Initialization phase	Contact your local service organization.
F282	Error: parameter data could not be saved	Contact your local service organization.
F283	Error: incorrect parameter data	Contact your local service organization.
F431	Error: incorrect calibration values	Contact your local service organization.
C411	Info: upload/download active	Only for information, device properly working.
C432	Info: calibration/testing mode	Only for information, device properly working.

Error code	Meaning	Remedy
C482	Info: simulation mode, relay/open collector	Only for information, device properly working.
C483	Info: analog output simulation mode	Only for information, device properly working.
C561	Display overflow	Only for information, device properly working.

10.3 Spare parts

 Order codes for spare parts can be found on www.endress.com/deviceviewer → Device support → Find spare parts.

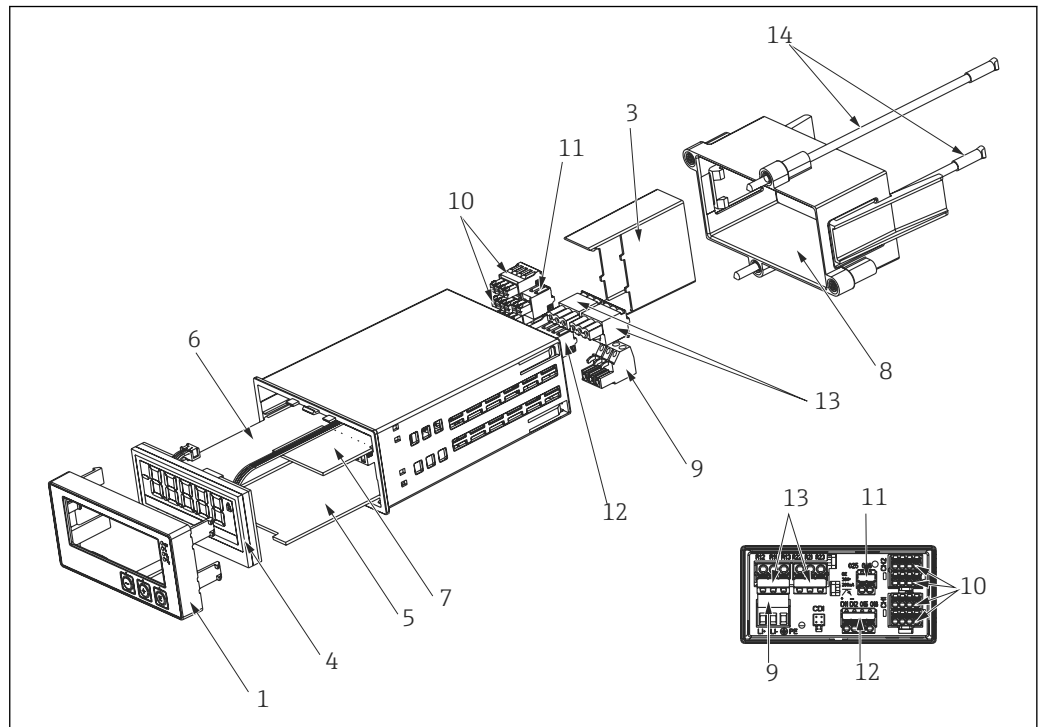

A0010213

 13 Spare parts

Item no.	Designation
1	Housing front with foil (incl. keyboard)
3	Terminal cover Ex
4	CPU with LCD display incl. housing front
5	Mainboard Mainboard 20-250 VDC/AC non-Ex Mainboard 20-250 VDC/AC, Ex-version
6	Multifunction input cards, incl. terminals Multifunction input card for channel 2, non-Ex Multifunction input card for channel 2, Ex-version
7	Relay card with 2 limit relays, incl. terminals
8	Mounting kit
9	Terminal, 3-pin for supply voltage

Item no.	Designation
10	Terminals 4-pin for analog input Terminal, analog input non-Ex (terminals x1, x2, x3, x4 and x5, x6, x7, x8) Terminal, analog input Ex, blue at top (terminals x1, x2, x3, x4) Terminal, analog input Ex, blue at bottom (terminals x5, x6, x7, x8)
11	Terminal for analog output 2 (O25, O26)
12	Terminal for analog output 1 and status output (DI 11, DI12, O15)
13	Terminal. relay output (R12, R11, R13 and R22, R21, R23)
14	Threaded rod for casing securing frame
w/o no.	Sealing ring housing/panel (only devices before 10/2010)

11 Return

The measuring device must be returned if it is need of repair or a factory calibration, or if the wrong measuring device has been delivered or ordered. Legal specifications require Endress+Hauser, as an ISO-certified company, to follow certain procedures when handling products that are in contact with the medium.

To ensure safe, swift and professional device returns, please refer to the procedure and conditions for returning devices provided on the Endress+Hauser website at <http://www.endress.com/support/return-material>

12 Disposal

The device contains electronic components and must therefore be disposed of as electronic waste. Comply with local disposal regulations.

13 Technical data

13.1 Input

13.1.1 Inputs

One or two universal inputs

13.1.2 Measured variable

Current, voltage, resistance, resistance thermometer, thermocouples

13.1.3 Measuring ranges

Current:

- 0/4 to 20 mA +10% overrange
- Short-circuit current: max. 150 mA
- Load: 10 Ω

Voltage:

- 0 to 10 V, 2 to 10 V, 0 to 5 V, 0 to 1 V, 1 to 5 V, ± 1 V, ± 10 V, ± 30 V, ± 100 mV
- Max. permitted input voltage:
 - Voltage ≥ 1 V: ± 35 V
 - Voltage < 1 V: ± 12 V
- Input impedance: $> 1\,000$ k Ω

Resistance:

30 to 3 000 Ω

Resistance thermometer:

- Pt100 as per IEC60751, GOST, JIS1604
- Pt500 and Pt1000 as per IEC60751
- Cu100, Cu50, Pt50, Pt46, Cu53 as per GOST
- Ni100, Ni1000 as per DIN 43760

Thermocouple types:

- Typ J, K, T, N, B, S, R as per IEC60584
- Typ U as per DIN 43710
- Typ L as per DIN 43710, GOST
- Typ C, D as per ASTM E998

13.1.4 Update time

200 ms

13.1.5 Linearization

Linearization of input signals and calculated values possible over a maximum of 32 points.

13.1.6 Galvanic isolation

Towards all other circuits

13.2 Output

13.2.1 Output signal

One or two analog outputs, galvanically isolated

13.2.2 Current/voltage output

Current output:

- 0/4 to 20 mA
- Overrange up to 22 mA

Voltage:

- 0 to 10 V, 2 to 10 V, 0 to 5 V, 1 to 5 V
- Overrange: up to 11 V, short-circuit proof, $I_{\max} < 25 \text{ mA}$

13.2.3 Loop power supply

- Open-circuit voltage: $24 V_{DC}$ (+15% /-5%)
Ex version: > 14 V at 22 mA
Non-hazardous operation: > 16 V at 22 mA
- Maximum 30 mA short-circuit-proof and overload-proof
- Galvanically isolated from system and outputs

13.2.4 HART®

HART® signals are not affected

13.2.5 Status output

Open Collector for monitoring of the device state and alarm notification. The OC output is closed in normal state. In error state, the OC output is opened.

- $I_{\max} = 200 \text{ mA}$
- $U_{\max} = 28 \text{ V}$
- $U_{\text{on}/\max} = 2 \text{ V}$ bei 200 mA

Galvanic isolation towards all other circuits; test voltage 500 V

13.2.6 Limit function

Relay contact	Changeover
Maximum contact burden DC	30 V / 3 A (permanent state, without destruction of the input)
Maximum contact burden AC	250 V / 3 A (permanent state, without destruction of the input)
Minimum contact load	500 mW (12 V/10 mA)
Galvanic isolation towards all other circuits	Test voltage 1 500 V_{AC}
Switching cycles	> 1 million

13.3 Power supply

13.3.1 Electrical connection

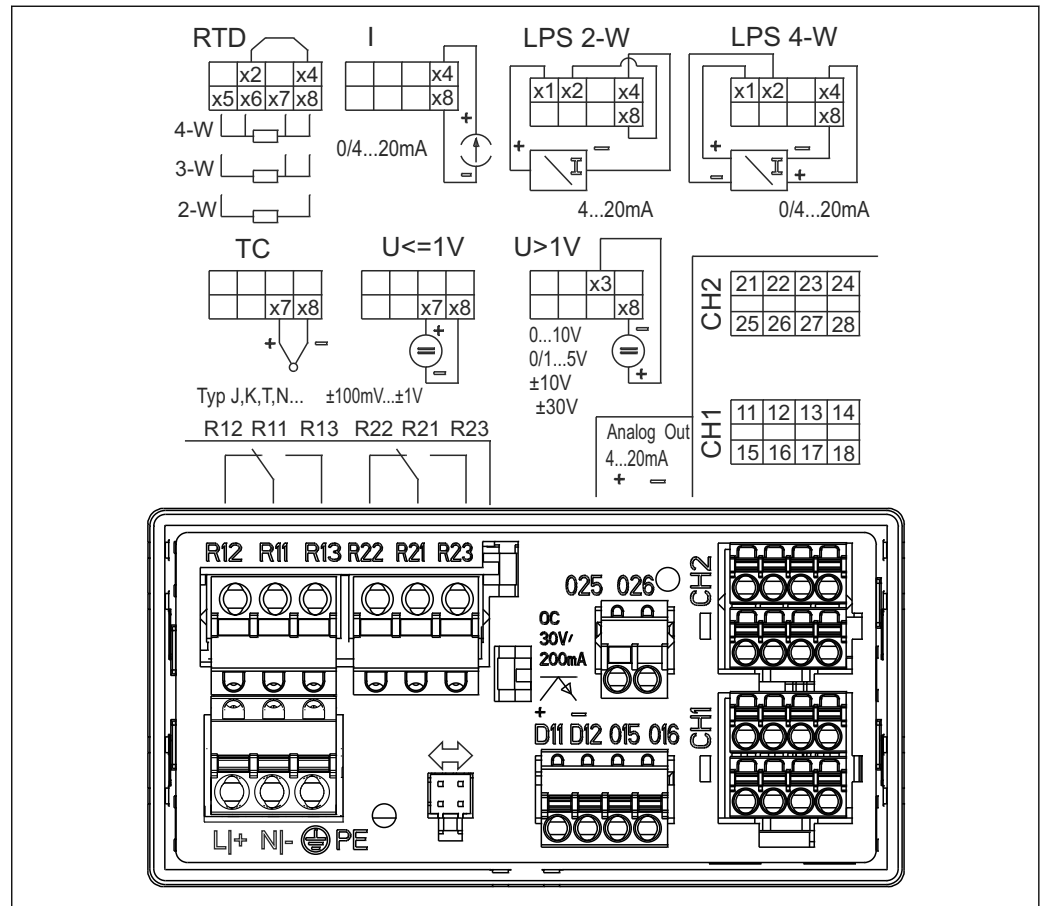

14 Terminal assignment of the panel meter (relays (terminals Rx1-Rx3) and channel 2 (terminals 21-28 and 025/026) optional)

13.3.2 Supply voltage

Wide-area power supply unit 24 to 230 V AC/DC (-20 % / +10 %) 50/60 Hz

13.3.3 Power consumption

Max. 21.5 VA / 6.9 W

13.3.4 Connection data interface

Commubox FXA291 PC USB interface

- Connection: 4-pin connector
- Transmission protocol: FieldCare
- Transmission rate: 38,400 Baud

Interface cable TXU10-AC PC USB interface

- Connection: 4-pin connection
- Transmission protocol: FieldCare
- Delivery scope: Interface cable incl. FieldCare Device Setup DVD with all Comm DTMs and Device DTMs

13.4 Performance characteristics

13.4.1 Reference operating conditions

Power supply: 230 V_{AC}, 50/60 Hz

Ambient temperature: 25 °C (77 °F) ± 5 °C (9 °F)

Humidity: 20 %...60 % rel. humidity

13.4.2 Maximum measured error

Universal input:

Accuracy	Input:	Range:	Maximum measured error of measuring range (oMR):
	Current	0 to 20 mA, 0 to 5 mA, 4 to 20 mA; Overrange: up to 22 mA	±0.05%
	Voltage ≥ 1 V	0 to 10 V, 2 to 10 V, 0 to 5 V, 1 to 5 V, 0 to 1 V, ±1 V, ±10 V, ±30 V	±0.1%
	Voltage < 1 V	±100 mV	±0.05%
	Resistance measurement	30 to 3 000 Ω	4-wire: ± (0.10% oMR + 0.8 Ω) 3-wire: ± (0.10% oMR + 1.6 Ω) 2-wire: ± (0.10% oMR + 3 Ω)
	RTD	Pt100, -200 to 850 °C (-328 to 1 562 °F) (IEC60751, α=0.00385) Pt100, -200 to 850 °C (-328 to 1 562 °F) (JIS1604, w=1.391) Pt100, -200 to 649 °C (-328 to 1 200 °F) (GOST, α=0.003916) Pt500, -200 to 850 °C (-328 to 1 562 °F) (IEC60751, α=0.00385) Pt1000, -200 to 600 °C (-328 to 1 112 °F) (IEC60751, α=0.00385)	4-wire: ± (0.10% oMR + 0.3 K (0.54 °F)) 3-wire: ± (0.10% oMR + 0.8 K (1.44 °F)) 2-wire: ± (0.10% oMR + 1.5 K (2.7 °F))
		Cu100, -200 to 200 °C (-328 to 392 °F) (GOST, w=1.428) Cu50, -200 to 200 °C (-328 to 392 °F) (GOST, w=1.428) Pt50, -200 to 1 100 °C (-328 to 2 012 °F) (GOST, w=1.391) Pt46, -200 to 850 °C (-328 to 1 562 °F) (GOST, w=1.391) Ni100, -60 to 250 °C (-76 to 482 °F) (DIN43760, α=0.00617) Ni1000, -60 to 250 °C (-76 to 482 °F) (DIN43760, α=0.00617)	4-wire: ± (0.10% oMR + 0.3 K (0.54 °F)) 3-wire: ± (0.10% oMR + 0.8 K (1.44 °F)) 2-wire: ± (0.10% oMR + 1.5 K (2.7 °F))
		Cu53, -50 to 200 °C (-58 to 392 °F) (GOST, w=1.426)	4-wire: ± (0.10% oMR + 0.3 K (0.54 °F)) 3-wire: ± (0.10% oMR + 0.8 K (1.44 °F)) 2-wire: ± (0.10% oMR + 1.5 K (2.7 °F))
	Thermocouples	Typ J (Fe-CuNi), -210 to 1 200 °C (-346 to 2 192 °F) (IEC60584)	± (0.10% oMR + 0.5 K (0.9 °F)) from -100 °C (-148 °F)
		Typ K (NiCr-Ni), -200 to 1 372 °C (-328 to 2 502 °F) (IEC60584)	± (0.10% oMR + 0.5 K (0.9 °F)) from -130 °C (-202 °F)
		Typ T (Cu-CuNi), -270 to 400 °C (-454 to 752 °F) (IEC60584)	± (0.10% oMR + 0.5 K (0.9 °F)) from -200 °C (-328 °F)
		Typ N (NiCrSi-NiSi), -270 to 1 300 °C (-454 to 2 372 °F) (IEC60584)	± (0.10% oMR + 0.5 K (0.9 °F)) from -100 °C (-148 °F)
		Typ L (Fe-CuNi), -200 to 900 °C (-328 to 1 652 °F) (DIN43710, GOST)	± (0.10% oMR + 0.5 K (0.9 °F)) from -100 °C (-148 °F)
		Typ D (W3Re/W25Re), 0 to 2 495 °C (32 to 4 523 °F) (ASTME998)	± (0.15% oMR + 1.5 K (2.7 °F)) from 500 °C (932 °F)

Accuracy	Input:	Range:	Maximum measured error of measuring range (oMR):
		Typ C (W5Re/W26Re), 0 to 2 320 °C (32 to 4 208 °F) (ASTME998)	± (0.15% oMR + 1.5 K (2.7 °F)) from 500 °C (932 °F)
		Typ B (Pt30Rh-Pt6Rh), 0 to 1 820 °C (32 to 3 308 °F) (IEC60584)	± (0.15% oMR + 1.5 K (2.7 °F)) from 600 °C (1 112 °F)
		Typ S (Pt10Rh-Pt), -50 to 1 768 °C (-58 to 3 214 °F) (IEC60584)	± (0.15% oMR + 3.5 K (6.3 °F)) für -50 to 100 °C (-58 to 212 °F) ± (0.15% oMR + 1.5 K (2.7 °F)) from 100 °C (212 °F)
		Typ U (Cu-CuNi), -200 to 600 °C (-328 to 1 112 °F) (DIN 43710)	± (0.15% oMR + 1.5 K (2.7 °F)) from 100 °C (212 °F)
AD converter resolution		16 bit	
Temperature drift		Temperature drift: ≤ 0.01%/K (0.1%/18 °F) oMR ≤ 0.02%/K (0.2%/18 °F) oMR for Cu100, Cu50, Cu53, Pt50 and Pt46	

Analog output:

Current	0/4 to 20 mA, overrange bis 22 mA	±0.05% of measuring range
	Max. load	500 Ω
	Max. inductivity	10 mH
	Max. capacity	10 µF
	Max. ripple	10 mVpp at 500 Ω, frequency < 50 kHz
Voltage	0 to 10 V, 2 to 10 V 0 to 5 V, 1 to 5 V Overrange: up to 11 V, shortcircuit proof, $I_{max} < 25$ mA	±0.05% of measuring range ±0.1 % of measuring range
	Max. ripple	10 mVpp at 1 000 Ω, frequency < 50 kHz
Resolution	13 bit	
Temperature drift	≤ 0.01%/K (0.1%/18 °F) of measuring range	
Galvanic isolation	Testing voltage of 500 V towards all other circuits	

13.5 Installation

13.5.1 Installation instructions

Mounting location

Panel, cutout 92 x 45 mm (3.62 x 1.77 in) (see 'Mechanical construction').

Max. panel thickness 26 mm (1 in).

Orientation

No restrictions.

The orientation is determined by the readability of the display.

Max. viewing angle range +/- 45° from the central display axis in every direction.

13.5.2 Environment

Ambient temperature range

NOTICE

The life-time of the display is shortened when operated in the upper temperature range.

- ▶ To avoid heat accumulation, always make sure the device is sufficiently cooled.

Non-Ex/Ex devices: -20 to 60 °C (-4 to 140 °F)

UL devices: -20 to 50 °C (-4 to 122 °F)

Storage temperature

-40 to 85 °C (-40 to 185 °F)

Operating height

< 2 000 m (6 560 ft) above MSL

Climate class

As per IEC 60654-1, Klasse B2

Degree of protection

Front IP 65 / NEMA 4 (not evaluated by UL)

Device casing/rear side IP 20

Electrical safety

Protection class I, overvoltage category II, pollution degree II

Condensation

Front: permitted

Device casing: not permitted

Electromagnetic compatibility (EMC)

- Interference immunity:
To IEC 61326 industrial environments / NAMUR NE 21
- Interference emissions:
To IEC 61326 Class A

13.6 Mechanical construction

13.6.1 Design, dimensions

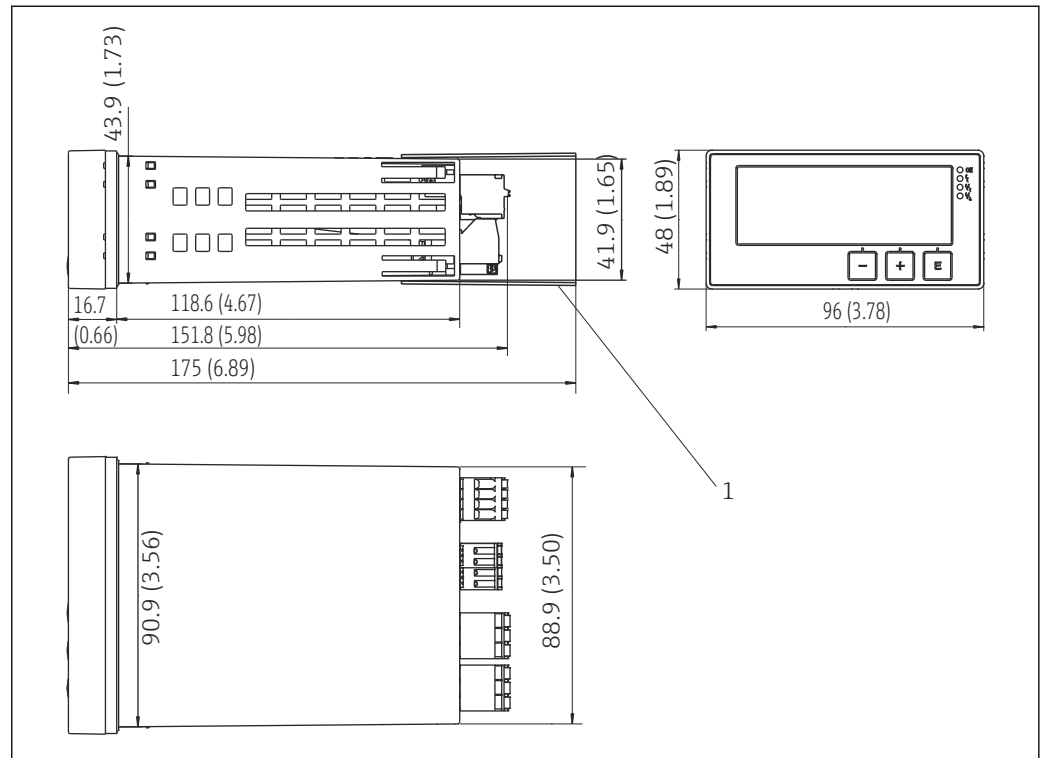

A0010208

15 Dimensions of the panel meter in mm (in)

1 Distance piece for terminals (Ex option)

13.6.2 Weight

Approximately 300 g (10.6 oz)

13.6.3 Material

Housing: plastic PC-GF10

13.6.4 Terminals

Spring terminals	
Relay / auxiliary voltage terminals	0.2 to 2.5 mm ² (24 to 12 AWG)
Input / output terminals	0.2 to 1.5 mm ² (24 to 16 AWG)

13.6.5 Panel thickness

Max. 26 mm (1 in)

13.7 Operability

13.7.1 Display elements

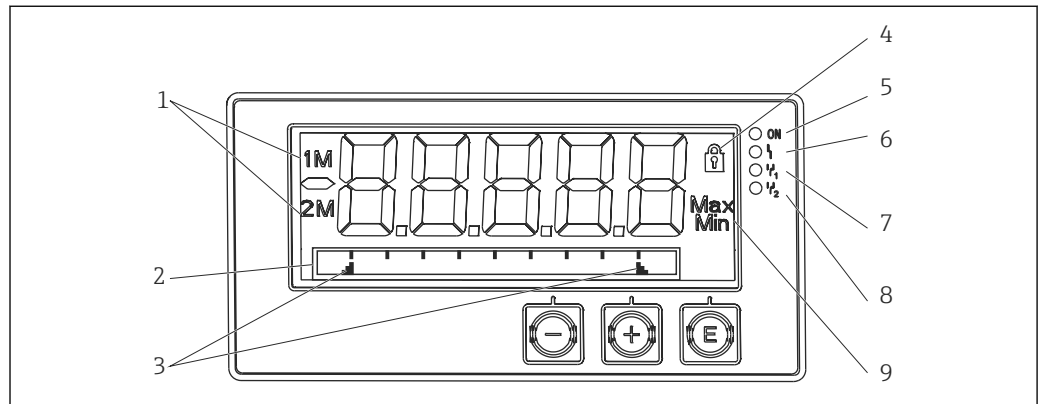

16 Display of the panel meter

- 1 Channel display: 1: analog input 1; 2: analog input 2; 1M: calculated value 1; 2M: calculated value 2
- 2 Dot matrix display for TAG, bar graph and unit
- 3 Limit value indicators in the bar graph
- 4 "Operation locked" indicator
- 5 Green LED; measuring device operational
- 6 Red LED; error/alarm
- 7 Yellow LED; status of relay 1
- 8 Yellow LED; status of relay 2
- 9 Minimum/maximum value indicator

- Display
 - 5-digit, 7-segment backlit LC display
 - Dot matrix for text/bar graph
- Display range
 - 99999 to +99999 for measured values
- Signaling
 - Setup security locking (lock)
 - Measuring range overshoot/undershoot
 - 2 x status relay (only if relay option was selected)

13.7.2 Operating elements

3 keys: -, +, E

13.7.3 Remote operation

Configuration

The device can be configured with the PC software or on site using the operating keys. FieldCare Device Setup is delivered together with the Commubox FXA291 or TXU10-AC (see 'Accessories') or can be downloaded free of charge from www.endress.com.

Interface

4-pin socket for the connection with a PC via Commubox FXA291 or TXU10-AC interface cable (see 'Accessories')

13.8 Certificates and approvals

13.8.1 CE mark

The device meets the legal requirements of the EU directives. Endress+Hauser confirms that the device has been tested successfully by affixing the CE mark.

13.8.2 Ex approval

Information about currently available Ex versions (ATEX, FM, CSA, etc.) can be supplied by your E+H Sales Center on request. All explosion protection data are given in a separate documentation which is available upon request.

13.8.3 Other standards and guidelines

- IEC 60529:
Degrees of protection by housing (IP code)
- IEC 61010-1: 2001 cor 2003
Safety requirements for electrical equipment for measurement, control and laboratory use
- EN 60079-11
Explosive atmospheres - Part 11: equipment protection by intrinsic safety "I"

13.8.4 Marine approval

Germanischer Lloyd (GL)

13.9 Documentation

- System Components and Data Managers - Solutions for the loop: FA00016K/09
- Technical Information Panel meter RIA45: TI00141R/09
- Ex Safety Instructions:
ATEX II(1)GD [Ex ia] IIC: XA00076R/09
- SIL Safety Manual:
SD00014R/09

14 Appendix

The following tables show all the parameters available in the configuration menu. The values configured at the factory are marked in bold.

14.1 Further explanations on the differential pressure application at level measurement

At both universal inputs pressure sensors are connected. With the following calculation steps the volume in the CV channels is finally calculated:

14.1.1 1st Calculation Step: Calculation of the filling level

Both pressure sensors provide the actual pressure at the installation point. From both pressures (possibly adjusted for an offset; this has to be set in AI1 respectively AI2) a pressure difference (Δp) is determined. If the pressure difference is divided through the density of the medium multiplied with the gravitational acceleration the measured height is gained.

$$\text{Level } h = \Delta p / (\rho * g)$$

The following units form the basis of the calculation:

- Density ρ [kg/m³]
- Pressure p: [Pa] or [N/m²]

The gravitational acceleration is defined by a constant:

$$\text{Gravitational acceleration } g = 9.81 \text{ m/s}^2$$

NOTICE

Wrong calculation results through use of incorrect engineering units

- If the calculation is to be carried through correctly the measured signal (e.g. in mbar) has to be converted into the according unit Pascal (Pa). This is achieved by a conversion factor. Conversion factors can be found in the table →  55.

Examples for the conversion:

Water: density $\rho = 1000 \text{ kg/m}^3$

Pressure measurement: pressure1 (bottom): Scale 0 to 800 mbar (0 to 80000 Pa);

Present value: 500 mbar (50000 Pa)

Pressure measurement: pressure2 (top): Scale 0 to 800 mbar (0 to 80000 Pa);

Present value: 150 mbar (15000 Pa)

When using Pascal:

$$h = \frac{1}{1000 \text{ kg/m}^3 * 9.81 \text{ m/s}^2} * (50000 - 15000 \text{ Pa}) = 3.57 \text{ m}$$

When using mbar:

$$h = \frac{1}{1000 \text{ kg/m}^3 * 9.81 \text{ m/s}^2} * ((500 - 150 \text{ mbar}) * (1.0000 * 10^2)) = 3.57 \text{ m}$$

$$h = b * \Delta p$$

Calculation of the correction factor b:

$$b = 1 / (\rho * g)$$

$$\text{for water: } b = 1 / (1000 * 9.81) = 0.00010194$$

Tables and examples for the conversion of application related units into the defined values kg/m³ and Pa or N/m²:

- 1 bar = 0,1 N/mm² = 10⁵ N/m² = 10⁵ Pa
- 1 mbar = 1 hPa = 100 Pa

Conversion factors for various pressure engineering units

	Pascal	Bar	Technical Atmosphere	Physical Atmosphere	Torr	Pounds per square inch
	[Pa]	[bar]	[at]	[atm]	[torr]	[psi]
	= 1 N/m ²	= 1 Mdyn/cm ²	= 1 kp/cm ²	= 1 pSTP	= 1 mmHg	= 1 lbf/in ²
1 Pa =	1	1.000 · 10 ⁻⁴	1.0197 · 10 ⁻⁵	9.8692 · 10 ⁻⁶	7.5006 · 10 ⁻³	1.4504 · 10 ⁻⁴
1 bar =	1.000 · 10 ⁵	1	1.0197 · 10 ⁰	9.8692 · 10 ⁻¹	7.5006 · 10 ²	1.4504 · 10 ¹
1 mbar =	1.000 · 10 ²	1.000 · 10 ⁻³	1.0197 · 10 ³	9.8692 · 10 ⁻⁴	7.5006 · 10 ⁻¹	1.4504 · 10 ⁻²
1 at =	9.8067 · 10 ⁴	9.8067 · 10 ⁻¹	1	9.6784 · 10 ⁻¹	7.3556 · 10 ²	1.4223 · 10 ¹
1 atm =	1.0133 · 10 ⁵	1.0133 · 10 ⁰	1.0332 · 10 ⁰	1	7.6000 · 10 ²	1.4696 · 10 ¹
1 torr =	1.3332 · 10 ²	1.3332 · 1 ⁻³	1.3595 · 10 ⁻³	1.3158 · 10 ⁻³	1	1.9337 · 10 ⁻²
1 psi =	6.8948 · 10 ³	6.8948 · 1 ⁻³				

Density:

The density has to be taken from the specifications of the medium that the tank contains.

In the given table standard approximate values that can help for a first orientation are listed

Medium	Density in [kg/m ³]
Water (at 3.98 °C (39.164 °F))	999.975
Mercury	13 595
Bromine	3 119
Sulfuric acid	1 834
Nitric acid	1 512
Glycerin	1 260
Nitrobenzene	1 220
Deuterium oxide	1 105
Acetic Acid	1 049
Milk	1 030
Seawater	1 025
Aniline	1 022
Olive oil	910
Benzene	879
Toluene	872
Spirits of turpentine	855
Spirit	830
Diesel fuel	830
Paraffin	800
Methanol	790
Ethyl alcohol	789
Automotive gas (standardized, average value)	750
Acetone	721

Medium	Density in [kg/m ³]
Disulfide	713
Diethyl ether	713

14.1.2 2nd Calculation step: Calculation of the volume out of the height

By means of the linearization of the calculated height value the volume can be calculated.

This is done by assigning a certain volume value to every height value in dependency of the tank shape.

This linearization is mapped over up to 32 supporting points. However, at a straight-linear dependency of filling height and volume are sufficient.

The integrated tank-linearization module in FieldCare provides support here.

14.2 Display menu

AI1/AI2 Reset minmax

Navigation	 Display → AI1 Reset minmax/AI2 Reset minmax
Description	Resets the minimum and maximum values saved for analog input 1 or analog input 2.
Options	yes no
Factory setting	no
Additional information	Only available if "Yes" was configured in the Setup → Analog in 1/Analog in 2 → Allow reset menu.

Cv1/Cv2 Reset minmax

Navigation	 Display → Cv1 Reset minmax/Cv2 Reset minmax
Description	Resets the minimum and maximum values saved for math 1 or math 2.
Options	yes no
Factory setting	no
Additional information	Only available if "Yes" was configured in the Setup → Calc val 1/Calc val 2 → Allow reset menu.

Analog in 1/2

Navigation	 Display → Analog in 1/Analog in 2
Description	Configures the display for analog input 1 or analog input 2. If the parameter is set to 'Off', the channel is not displayed.
Options	off Unit Bargraph Bar + unit Tag + unit
Factory setting	Tag + unit

 Calc value 1/2

Navigation	☰ Display → Calc value 1/Calc value 1
Description	Configures the display for math 1 or math 2. If the parameter is set to 'Off', the channel is not displayed.
Options	off Unit Bargraph Bar + unit Tag + unit
Factory setting	off

 Contrast

Navigation	☰ Display → Contrast
Description	Configures the contrast
Options	1...7
Factory setting	6

 Brightness

Navigation	☰ Display → Brightness
Description	Configures the brightness
Options	1...7
Factory setting	6

 Alternating time

Navigation	☰ Display → Alternating time
Description	Configures the time for toggling between the channels displayed.
Options	3 seconds 5 seconds 10 seconds
Factory setting	5 seconds

14.3 Setup menu

 Application

Navigation	☰ Setup → Application
Description	Configures the application for the process display unit.
Options	1-channel 2-channel Diff pressure
Factory setting	1- / 2-channel
Additional information	2-channel is the default setting for two-channel devices, 1-channel for single-channel devices.

 AI1/AI2 Lower range

Navigation	 Setup → AI1 Lower range/AI2 Lower range
Description	Configures the measuring range lower limit
User entry	Numerical value ¹⁾
Factory setting	0.0000
Additional information	Only visible if → Diff pressure is configured as the application.

 AI1/AI2 Upper range

Navigation	 Setup → AI1 Upper range/AI2 Upper range
Description	Configures the measuring range upper limit
User entry	Numerical value ¹⁾
Factory setting	100.00
Additional information	Only visible if → Diff pressure is configured as the application.

 CV factor

Navigation	 Setup → CV factor
Description	Factor by which the calculated value is multiplied.
User entry	Numerical value ¹⁾
Factory setting	1.0
Additional information	Only visible if → Diff pressure is configured as the application.

 CV unit

Navigation	 Setup → CV unit
Description	Unit of the calculated value
Options	Customized text, max. 5 digits
Additional information	Only visible if → Diff pressure is configured as the application.

 CV Bar 0%

Navigation	 Setup → CV Bar 0%
Description	Configures the 0%-value for the bar graph
User entry	Numerical value ¹⁾
Factory setting	0.0000
Additional information	Only visible if → Diff pressure is configured as the application.

 CV Bar 100%

Navigation	 Setup → CV Bar 100%
Description	Configures the 100%-value for the bar graph
User entry	Numerical value ¹⁾

Factory setting	100.00
Additional information	Only visible if → Diff pressure is configured as the application.

 Submenu "Linearization"

Navigation	 Setup → Linearization
Description	Only visible if → Diff pressure is configured as the application.

 No lin points

Navigation	 Setup → Linearization → No lin points
Description	Number of points needed for linearization.
User entry	2...32
Factory setting	2

 X-value 1...X-value 32

Navigation	 Setup → Linearization → X-value 1...X-value 32
Description	X-value for the linearization point in question
User entry	Numerical value ¹⁾
Factory setting	0.0000

 Y-value 1...Y-value 32

Navigation	 Setup → Linearization → Y-value 1...Y-value 32
Description	Y-value for the linearization point in question
User entry	Numerical value ¹⁾
Factory setting	0.0000

 Submenu "Analog in 1"/"Analog in 2"

Navigation	 Setup → Analog in 1/Analog in 2
Additional information	Settings for analog input 1 or analog input 2

 Signal type

Navigation	 Setup → Analog in 1/Analog in 2 → Signal type
Description	Configures the input type.
Options	off Current Voltage RTD TC
Factory setting	Current
Additional information	If "Signal type" is set to "Off", all the parameters under it are hidden.

 Signal range

Navigation	 Setup → Analog in 1/Analog in 2 → Signal range
Description	Configures the input signal. Which options are available for selection depends on the "Signal type" set.
Options	4-20mA, 4-20mA squar, 0-20mA, 0-20mA squar 0-10V, 0-10V squar, 0-5V, 2-10V, 1-5V, 1-5V squar, 0-1V, 0-1V squar, +/- 1V, +/- 10V, +/- 30V, +/- 100mV Pt46GOST, Pt50GOST, Pt100IEC, Pt100JIS, Pt100GOST, Pt500IEC, Pt1000IEC, Ni100DIN, Ni1000DIN, Cu50GOST, Cu53GOST, Cu100GOST, 3000 Ohm Typ B, Typ J, Typ K, Typ N, Typ R, Typ S, Typ T, Typ C, Typ D, Typ L, Typ L GOST, Typ U
Factory setting	4-20mA, 0-10V, Pt100IEC, Typ J; depending on the selected input signal

 Lower range

Navigation	 Setup → Analog in 1/Analog in 2 → Lower range
Description	Configures the measuring range lower limit
User entry	Numerical value ¹⁾
Factory setting	0
Additional information	Only displayed if "Signal type" = "Current" or "Voltage" is set.

 Upper range

Navigation	 Setup → Analog in 1/Analog in 2 → Upper range
Description	Configures the measuring range upper limit
User entry	Numerical value ¹⁾
Factory setting	100
Additional information	Only displayed if "Signal type" = "Current" or "Voltage" is set.

 Connection

Navigation	 Setup → Analog in 1/Analog in 2 → Connection
Description	Configures the connection type for RTD thermometers
Options	2-wire 3-wire 4-wire
Factory setting	2-wire
Additional information	Displayed if "Signal type" = "RTD" is set.

 Tag

Navigation	 Setup → Analog in 1/Analog in 2 → Tag
Description	Channel name; TAG is the device designation for channel 1
User entry	Customized text, max. 12 digits

 Unit

Navigation	☰ Setup → Analog in 1/Analog in 2 → Unit
Description	Unit of the channel
Input	Customized text, max. 5 digits
Additional information	Only displayed if "Signal type" = "Current" or "Voltage" is set.

 Temperature unit

Navigation	☰ Setup → Analog in 1/Analog in 2 → Temperature unit
Description	Configures the temperature unit
Options	°C °F K
Factory settings	°C
Additional information	Only displayed if "Signal type" = "RTD" or "TC" is set.

 Offset

Navigation	☰ Setup → Analog in 1/Analog in 2 → Offset
Description	Configures an offset
User entry	Numerical value ¹⁾
Factory setting	0

 Ref junction

Navigation	☰ Setup → Analog in 1/Analog in 2 → Ref junction
Description	Configures the reference temperature
Options	intern fixed
Factory setting	intern
Additional information	Only displayed if "Signal type" = "TC" is set.

 Fixed ref junc

Navigation	☰ Setup → Analog in 1/Analog in 2 → Fixed ref junc
Description	Configures the constant reference temperature
User entry	Numerical value ¹⁾
Additional information	Only visible if "fixed" was selected for the "Ref junction".

 Reset min/max

Navigation	☰ Setup → Analog in 1/Analog in 2 → Reset min/max
-------------------	---

Description	Resets the min./max. values saved.
Options	no yes
Factory setting	no

 Submenu "Calc value 1"/"Calc value 2"

Navigation  Setup → Calc value 1/Calc value 2

Additional information Settings for math 1 or math 2

 Calculation

Navigation  Setup → Calc value 1/Calc value 2 → Calculation

Description Selects the calculation method.

Options off
Sum
Difference
Average
Lineariz. AI1 / Lineariz. AI2
Lineariz. CV1 (Calc value 2 only)
Multiplication

Factory setting off

Additional information If "Calculation" is set to "Off", all the parameters under it are hidden.

 Tag

Navigation  Setup → Calc value 1/Calc value 2 → Tag

Description Channel name

User entry Customized text, max. 12 digits

 Unit

Navigation  Setup → Calc value 1/Calc value 2 → Unit

Description Unit of the channel

User entry Customized text, max. 5 digits

 Bar 0%

Navigation  Setup → Calc value 1/Calc value 2 → Bar 0%

Description Configures the 0%-value for the bar graph

User entry Numerical value¹⁾

Factory setting 0

 Bar 100%

Navigation  Setup → Calc value 1/Calc value 2 → Bar 100%

Description	Configures the 100%-value for the bar graph
User entry	Numerical value ¹⁾
Factory setting	100

Factor

Navigation  Setup → Calc value 1/Calc value 2 → Factor

Description	Setting of factor for calculated value
User entry	Numerical value ¹⁾
Factory setting	1.0

Offset

Navigation  Setup → Calc value 1/Calc value 2 → Offset

Description	Configures an offset
User entry	Numerical value ¹⁾
Factory setting	0

No. lin points

Navigation  Setup → Calc value 1/Calc value 2 → No. lin points

Description	Number of points for linearization.
User entry	2...32
Factory setting	2
Additional information	Only visible if "Calculation" = "Linearization" was set.

X-value

Navigation  Setup → Calc value 1/Calc value 2 → X-value

Description	For entering the points for linearization (max. 32)
User entry	X-value 1...X-value 32, numerical value ¹⁾
Factory setting	0
Additional information	Only visible if "Calculation" = "Linearization" was set.

Y-value

Navigation  Setup → Calc value 1/Calc value 2 → Y-value

Description	For entering the points for linearization (max. 32)
User entry	Y-value 1...Y-value 32, numerical value ¹⁾
Factory setting	0
Additional information	Only visible if "Calculation" = "Linearization" was set.

Reset min/max

Navigation  Setup → Calc value 1/Calc value 2 → Reset min/max

Description	Resets the min./max. values saved.
Options	no yes
Factory setting	no

 Submenu "Analog Out 1"/"Analog Out 2"

Navigation	 Setup → Analog Out 1/Analog Out 2
Additional information	Settings for analog output 1 or analog output 2

 Assignment

Navigation	 Setup → Analog Out 1/Analog Out 2 → Assignment
Description	Selects the source for the output signal
Options	off Analog 1 Analog 2 Calc Val 1 Calc Val 2
Factory setting	off

 Signal type

Navigation	 Setup → Analog Out 1/Analog Out 2 → Signal type
Description	Selects the type of signal for the output signal
Options	4-20mA 0-20mA 0-10V 2-10V 0-5V 1-5V
Factory setting	4-20mA

 Lower range

Navigation	 Setup → Analog Out 1/Analog Out 2 → Lower range
Description	Configures the measuring range lower limit
User entry	Numerical value ¹⁾
Factory setting	0

 Upper range

Navigation	 Setup → Analog Out 1/Analog Out 2 → Upper range
Description	Configures the measuring range upper limit
User entry	Numerical value ¹⁾
Factory setting	100

 Submenu "Relay 1"/"Relay 2"

Navigation	☰ Setup → Relay 1/Relay 2
Additional information	Settings for relay 1 or relay 2

 Source

Navigation	☰ Setup → Relay 1/Relay 2 → Source
Description	Selects the source for the relay
Options	off Analog input 1 Analog input 2 Calc value 1 Calc value 2 Error
Factory setting	off

 Function

Navigation	☰ Setup → Relay 1/Relay 2 → Function
Description	Function of the relay
Options	Min Max Gradient Inband Outband
Factory setting	Min

 Setpoint

Navigation	☰ Setup → Relay 1/Relay 2 → Setpoint
Description	Switching threshold for relay
User entry	Numerical value ¹⁾
Factory setting	0

 Setpoint 2

Navigation	☰ Setup → Relay 1/Relay 2 → Setpoint 2
Description	Second switching threshold for relay.
User entry	Numerical value ¹⁾
Factory setting	0
Additional information	Only for the inband and outband functions.

 Time base

Navigation	☰ Setup → Relay 1/Relay 2 → Time base
-------------------	---------------------------------------

Description	Time base for gradient calculation in seconds
User entry	0-60
Factory setting	0
Additional information	Only visible if "Function" = "Gradient" was set

Hysteresis

Navigation	 Setup → Relay 1/Relay 2 → Hysteresis
Description	Hysteresis for switching threshold(s)
User entry	Numerical value ¹⁾
Factory setting	0



Submenu "System"

Navigation	 Setup → System
-------------------	--

Access code

Navigation	 Setup → System → Access code
Description	User code to protect the device configuration.
User entry	0000...9999
Factory setting	0000
Additional information	0000 = protection through user code disabled

Overfill protect

Navigation	 Setup → System → Overfill protect
Description	If the device is used for overfill protection →  31, "Yes" must be selected for "Overfill protect".
Options	no yes
Factory setting	no

Reset

Navigation	 Setup → System → Reset
Description	Resets the device to the order configuration.
Options	no yes
Factory setting	no

1) Numerical values consist of 6 digits where the decimal point counts as a digit, e.g. +99.999

14.4 Diagnostics menu

Current diagn

Navigation	☰ Diagnostics → Current diagn
Description	Displays the error code currently present
Last diagn	
Navigation	☰ Diagnostics → Last diagn
Description	Displays the last error code
Operating time	
Navigation	☰ Diagnostics → Operating time
Description	Displays the hours operated up until now
Submenu "Diagnost logbook"	
Navigation	☰ Diagnostics → Diagnost logbook
Description	Displays the last 5 error codes
Diagnostics x	
Navigation	☰ Diagnostics → Diagnost logbook → Diagnostics x
Description	Displays a message from the diagnostics logbook.
Submenu "Device information"	
Navigation	☰ Diagnostics → Device information
Device tag	
Navigation	☰ Diagnostics → Device information → Device tag
Description	Displays the device name i TAG channel 1
Serial number	
Navigation	☰ Diagnostics → Device information → Serial number
Description	Displays the serial number
Order code	
Navigation	☰ Diagnostics → Device information → Order code
Description	Displays the order code

Order identifier	
Navigation	☰ Diagnostics → Device information → Order identifier
Description	Displays the order number
Firmware version	
Navigation	☰ Diagnostics → Device information → Firmware version
Description	Displays the firmware version
ENP Version	
Navigation	☰ Diagnostics → Device information → ENP Version
Description	Displays the ENP version

14.5 Expert menu

In addition to all the parameters in the Setup menu, the following parameters are also available in the Expert mode:

Direct access	
Navigation	☰ Expert → Direct access
Description	Code for direct access to an operating parameter.
User entry	4-digit code
Submenu "System"	
Navigation	☰ Expert → System
Save user setup	
Navigation	☰ Expert → System → Save user setup
Description	Select 'Yes' to save the current device settings. The device can be reset to the saved settings by means of 'Reset'-'>'User reset'.
Options	No Yes
Factory setting	No
Submenu "Input"	
Navigation	☰ Expert → Input

 Submenu "Analog in 1"/"Analog in 2"

Navigation	☰ Expert → Input → Analog in 1/Analog in 2
Description	Settings for the analog inputs.
Additional information	The following parameters are available for analog input 1 and analog input 2.

 Bar 0%

Navigation	☰ Expert → Input → Analog in 1/Analog in 2 → Bar 0%
Description	Configures the 0%-value for the bar graph
User entry	Numerical value ¹⁾
Factory setting	0

 Bar 100%

Navigation	☰ Expert → Input → Analog in 1/Analog in 2 → Bar 100%
Description	Configures the 100%-value for the bar graph
User entry	Numerical value ¹⁾
Factory setting	100

 Decimal places

Navigation	☰ Expert → Input → Analog in 1/Analog in 2 → Decimal places
Description	Configures the number of decimal places for the display
Options	XXXXX XXXX.X XXX.XX XX.XXX X.XXXX
Factory setting	XXX.XX

 Damping

Navigation	☰ Expert → Input → Analog in 1/Analog in 2 → Damping
Description	Configures the damping for the input signal. Entry in steps of 0.1 s from 0.0 s to 999.9 s.
User entry	Numerical value ¹⁾
Factory setting	0.0 for current / voltage 1.0 for temperature inputs

 Failure mode

Navigation	☰ Expert → Input → Analog in 1/Analog in 2 → Failure mode
-------------------	---

Description	Configures the failsafe mode.
Options	Invalid Fixed value
Factory settings	Invalid
Additional information	Invalid: an invalid value is output in the event of an error. Fixed value: a fixed value is output in the event of an error.

Fixed fail value

Navigation	 Expert → Input → Analog in 1/Analog in 2 → Fixed fail value
Description	The value configured here is output in the event of an error.
User entry	Numerical value ¹⁾
Factory setting	0
Additional information	Only visible if "Fixed value" was selected for the "Failure mode".

Namur NE 43

Navigation	 Expert → Input → Analog in 1/Analog in 2 → Namur NE 43
Description	Setting as to whether the failsafe mode is in accordance with NAMUR NE 43.
Options	On Off
Factory setting	On

Open circ detect

Navigation	 Expert → Input → Analog in 1/Analog in 2 → Open circ detect
Description	Sets cable open circuit detection.
Options	On Off
Factory setting	On
Additional information	Only visible if "1-5 V" is configured as the signal range.

Failure delay

Navigation	 Expert → Input → Analog in 1/Analog in 2 → Failure delay
Description	Delay time for failure in s
User entry	Integer value (0-99)
Factory setting	0

Allow reset

Navigation	 Expert → Input → Analog in 1/Analog in 2 → Allow reset
-------------------	--

Description	Setting as to whether saved min./ max. values can be reset in the Display menu without having to enter a user code which may already have been configured.
Options	No Yes
Factory setting	No

 Submenu "Output"

Navigation	☰ Expert → Output
-------------------	-------------------

 Submenu "Analog Out 1"/"Analog Out 2"

Navigation	☰ Expert → Output → Analog Out 1/Analog Out 2
-------------------	---

Description	Settings for the analog outputs.
Additional information	The following parameters are available for the analog output 1 and analog output 2.

 Failure mode

Navigation	☰ Expert → Output → Analog Out 1/Analog Out 2 → Failure mode
-------------------	--

Description	Configures the failsafe mode.
Options	Min Max Fixed value
Factory setting	Min
Additional information	Min: the saved minimum value is output in the event of an error. Max: the saved maximum value is output in the event of an error. Fixed value: a fixed value is output in the event of an error.

 Fixed fail value

Navigation	☰ Expert → Output → Analog Out 1/Analog Out 2 → Fixed fail value
-------------------	--

Description	The value configured here is output in the event of an error.
User entry	Numerical value ¹⁾
Factory setting	0
Additional information	Only visible if "Fixed value" was selected for the "Failure mode".

 Submenu "Relay 1"/"Relay 2"

Navigation	☰ Expert → Output → Relay 1/Relay 2
-------------------	-------------------------------------

Description	Settings for the relays.
Additional information	The following parameters are available for relay 1 and relay 2.

 Time delay

Navigation	☰ Expert → Output → Relay 1/Relay 2 → Time delay
-------------------	--

Description	Delay for switching the relay.
User entry	0-9999
Factory setting	0

Operating mode

Navigation	 Expert → Output → Relay 1/Relay 2 → Operating mode
Description	Normally closed = breaker contact Normally opened = maker contact
Options	normally closed normally opened
Factory setting	normally closed

Failure mode

Navigation	 Expert → Output → Relay 1/Relay 2 → Failure mode
Description	Normally closed = breaker contact Normally opened = maker contact
Options	normally closed normally opened
Factory setting	normally closed

Untermenü "Application"

Navigation	 Expert → Application
-------------------	--

Submenu "Calc value 1"/"Calc value 2"

Navigation	 Expert → Application → Calc value 1/Calc value 2
Description	Settings for the mathematics channels.
Additional information	The following parameters are available for math 1 and math 2.

Decimal places

Navigation	 Expert → Application → Calc value 1/Calc value 2 → Decimal places
Description	Configures the number of decimal places for the display
Options	XXXXX XXXX.X XXX.XX XX.XXX X.XXXX
Factory setting	XXX.XX

Failure mode

Navigation	 Expert → Application → Calc value 1/Calc value 2 → Failure mode
-------------------	---

Description	Configures the failsafe mode
Options	Invalid Fixed value
Factory setting	Invalid

Fixed fail value

Navigation	☰ Expert → Application → Calc value 1/Calc value 2 → Fixed fail value
Description	The value configured here is output in the event of an error.
User entry	Numerical value ¹⁾
Factory setting	0
Additional information	Only visible if "Fixed value" was selected for the "Failure mode".

Allow reset

Navigation	☰ Expert → Application → Calc value 1/Calc value 2 → Allow reset
Description	Setting as to whether saved min./ max. values can be reset in the Display menu without having to enter a user code which may already have been configured.
Options	No Yes
Factory setting	No

Submenu "Diagnostics"

Navigation	☰ Expert → Diagnostics
-------------------	------------------------

Verify HW set

Navigation	☰ Expert → Diagnostics → Verify HW set
Description	Device hardware check.
Options	Yes No
Factory setting	No

Submenu "Simulation"

Navigation	☰ Expert → Simulation
-------------------	-----------------------

Simulation A01/A02

Navigation	☰ Expert → Simulation → Simulation A01/Simulation A01
-------------------	---

Description	Simulation of analog output 1 or analog output 2. The value configured in the simulation is output at analog output 1 or analog output 2.
Options	Off 0mA 3.6mA 4mA 10mA 12mA 20mA 21mA 0V 5V 10V
Factory setting	Off

Simu relay 1/2

Navigation	 Expert → Simulation → Simu relay 1/Simu relay 2
Description	Simulation of relay 1 or relay 2.
Options	off closed opened
Factory setting	off

1) Numerical values consist of 6 digits where the decimal point counts as a digit, e.g. +99.999

Index

A

- Access protection 30
- Application conditions
 - Configuration 22

C

- Cable open circuit detection 35
- CE mark 7
- Configuration
 - 'Setup' menu item 24
 - Access protection 30
 - Advanced device configuration 30
 - Analog output 26
 - Application conditions 22
 - Calculations 25
 - Differential pressure application 23
 - Display functions 31
 - Expert 32
 - Limit values 26
 - Operating code 30
 - Overfill protection 31
 - Relay 26
 - Universal input 24
- Configuration via PC configuration software 14
- Connection 11

D

- Declaration of Conformity 7
- Delay and hysteresis at one limit value 29
- Device configuration
 - Allgemeines 21
 - Setup access protection 21
- Device malfunction 40
- Device reset 37
- Differential pressure application 23
- Dimensions 9
- Display 16
- Display functions 31
- Display icons 16
- Document
 - Function 4
- Document function 4

E

- Error codes 40
- Expert menu 32

F

- Failsafe mode 35

H

- Hysteresis and delay at one limit value 29

I

- Icons 16
- Incoming acceptance 9
- Installation conditions 9

L

- Local operation 14

M

- Measuring range limits 35
- Min./max. memory 35

N

- Nameplate 8

O

- Operating elements 14
- Operating hours counter 37
- Operating matrix 17
- Operational safety 6
- Overfill protection 31

P

- Parameter
 - Access code 66
 - AI1/AI2 Lower range 58
 - AI1/AI2 Reset minmax 56
 - AI1/AI2 Upper range 58
 - Allow reset 70, 73
 - Alternating time 57
 - Analog in 1/2 56
 - Application 57
 - Assignment 64
 - Bar 0% 62, 69
 - Bar 100% 62, 69
 - Brightness 57
 - Calc value 1/2 57
 - Calculation 62
 - Connection 60
 - Contrast 57
 - Current diagn 66
 - CV Bar 0% 58
 - CV Bar 100% 58
 - CV factor 58
 - CV unit 58
 - Cv1/Cv2 Reset minmax 56
 - Damping 69
 - Decimal places 69, 72
 - Device tag 67
 - Diagnostics x 67
 - Direct access 68
 - ENP Version 68
 - Factor 63
 - Failure delay 70
 - Failure mode 69, 71, 72
 - Firmware version 68
 - Fixed fail value 70, 71, 73
 - Fixed ref junc 61
 - Function 65
 - Hysteresis 66
 - Last diagn 67
 - Lower range 60, 64

Namur NE 43	70	Spare parts	41
No lin points	59	Storage	9
No. lin points	63	Submenu	
Offset	61, 63	Analog in 1/2	59, 69
Open circ detect	70	Analog Out 1/2	64, 71
Operating mode	72	Calc value 1/2	62, 72
Operating time	67	Device information	67
Order code	67	Diagnost logbook	67
Order identifier	68	Diagnostics	73
Overfill protect	66	Input	68
Ref junction	61	Linearization	59
Reset	66	Output	71
Reset min/max	61, 63	Relay 1/2	65, 71
Save user setup	68	Simulation	73
Serial number	67	System	66, 68
Setpoint	65	T	
Setpoint 2	65	Transport	9
Signal range	60	Transportation and storage	9
Signal type	59, 64	U	
Simu relay 1/2	74	Untermenü	
Simulation AO1/AO2	73	Application	72
Source	65	W	
Tag	60, 62	W@M Device Viewer	41
Temperature unit	61	Workplace safety	6
Time base	65		
Time delay	71		
Unit	61, 62		
Upper range	60, 64		
Verify HW set	73		
X-value	63		
X-value 1...X-value 32	59		
Y-value	63		
Y-value 1...Y-value 32	59		
Post-connection check	13		
Product safety	7		
Q			
Quick pick keys	35		
R			
Relay			
Operating mode			
Gradient	28		
InBand	29		
Max	27		
Min	27		
Off	27		
OutBand	28		
Specification	27		
Requirements for personnel	6		
Reset	37		
Return	43		
S			
Saving diagnostic alarms and errors	36		
Saving diagnostic events	36		
Scope of delivery	8		
Self-diagnosis	35		
Setup sichern	30		

www.addresses.endress.com

TRANSCAT[®]
Trust in every measure

Visit us at Transcat.com 

sales@transcat.com 1.800.828.1470

Endress+Hauser 
People for Process Automation