

# Reference Manual

## Advanced Signal Multi-scanner

JOFRA ASM-801/802/803 A/B

© Copyright 2009 AMETEK Denmark A/S



Visit [TRANSCAT.com](http://TRANSCAT.com) >

[sales@transcat.com](mailto:sales@transcat.com) | 800.828.1470

# About this manual....

---

- **The structure of the manual**

This reference manual is aimed at users who are familiar with AMETEK multi-scanners, as well as those who are not. The manual is divided into 11 chapters, which describe how to set up, operate, service and maintain the Multi-scanner. The technical specifications are described and accessories may be ordered from the list of accessories.

- **Safety symbols**

This manual contains a number of safety symbols designed to draw your attention to instructions, which must be followed when using the instrument, as well as any risks involved.



## **Warning**

Events, which may compromise the safe use of the instrument and result in considerable personal or material damage.



## **Caution...**

Events, which may compromise the safe use of the instrument and result in slight personal or material damage.



## **Note...**

Special situations, which demand the user's attention.

# List of contents

---

<b>1.0</b>	<b>Introduction .....</b>	<b>5</b>
<b>2.0</b>	<b>Safety instructions .....</b>	<b>7</b>
<b>3.0</b>	<b>Receiving the multi-scanner .....</b>	<b>9</b>
3.1	Multi-scanner models.....	11
3.1.1	A Model version.....	12
3.1.2	B Model version.....	14
<b>4.0</b>	<b>Setting up the multi-scanner .....</b>	<b>15</b>
4.1	Preparing the multi-scanner.....	16
4.2	Connecting sensors to the multi-scanner .....	17
4.2.1	Connecting RTDs .....	18
4.2.2	Connecting Thermocouples and Voltages Sources .....	18
4.2.3	Connecting 4-20mA Transmitters.....	20
4.3	Cascading the multi-scanner .....	21
4.4	Connecting A-models to other instruments .....	22
<b>5.0</b>	<b>Operating the multi-scanner .....</b>	<b>23</b>
5.1	Manual operation .....	23
5.2	Operation with JOFRACAL.....	24
<b>6.0</b>	<b>Remote operation.....</b>	<b>25</b>
6.1	Setting up the RS-232 Port for Remote Control .....	25
6.2	Units.....	26
6.2.1	Temperature units .....	26
6.2.2	Electrical units .....	26
6.3	Commands.....	26
6.3.1	*CLS .....	26
6.3.2	*ESE <reg val> .....	26
6.3.3	*ESE? .....	27
6.3.4	*ESR?.....	27
6.3.5	*IDN?.....	27
6.3.6	*OPC .....	27
6.3.7	*OPC? .....	28
6.3.8	*RST .....	28
6.3.9	*SRE <reg val>.....	28
6.3.10	*SRE? .....	28
6.3.11	*STB?.....	28
6.3.12	*TST? .....	28
6.3.13	*WAI.....	29
6.3.14	SYSTEM_IDN? .....	29

6.3.15	SYS_CONF.....	29
6.3.16	SYS_CONF?.....	29
6.3.17	TEMP_UNIT.....	30
6.3.18	TEMP_UNIT?.....	30
6.3.19	CH_CONF.....	30
6.3.20	CH_CONF? (@<channel>).....	32
6.3.21	VAL? (@<ch_list >).....	33
6.3.22	CH_SCAN (@<ch_list>).....	33
6.3.23	CH_SCAN_STOP.....	33
6.3.24	CH_SCAN?.....	33
6.3.25	CAL_DATE.....	33
<b>7.0</b>	<b>Maintenance.....</b>	<b>34</b>
7.1	Storing.....	34
7.2	Cleaning.....	34
7.3	Returning the multi-scanner to service.....	34
<b>8.0</b>	<b>Errors.....</b>	<b>37</b>
<b>9.0</b>	<b>Adjusting the multi-scanner.....</b>	<b>39</b>
9.1	Adjusting and calibrating the instrument.....	39
9.2	Introduction to AMETRIM Software.....	39
9.2.1	Installing the AMETRIM Software.....	40
9.2.2	Connecting the PC and the ASM-80x.....	40
9.2.3	Starting the AMETRIM Software.....	40
9.2.4	Run calibration/adjustment.....	42
9.2.5	To calibrate the ASM-80x.....	45
9.2.6	To adjust and calibrate (as left) the ASM-80x.....	46
9.2.7	To calibrate (as found), adjust and calibrate (as left) the ASM-80x.....	48
9.2.8	Setup Printer.....	49
<b>10.0</b>	<b>Technical specifications.....</b>	<b>50</b>
<b>11.0</b>	<b>List of accessories.....</b>	<b>60</b>

# 1.0 Introduction

---

## ***Congratulations on your new AMETEK JOFRA Advanced Signal Multi-scanner!***

With the AMETEK JOFRA Multi-scanner, you have chosen an extremely effective instrument, which we hope will perform according to your expectations. During the past several years, we have acquired extensive knowledge of industrial temperature calibration. This expertise is reflected in our products, which are all designed for daily use in an industrial environment. Please note that we would be very interested in hearing from you if you have any ideas or suggestions for changes to our products.

This reference manual applies to the following instruments:

- **JOFRA ASM-801 A**
- **JOFRA ASM-801 B**
- **JOFRA ASM-802 A**
- **JOFRA ASM-802 B**
- **JOFRA ASM-803 A**
- **JOFRA ASM-803 B**

### **ISO-9001 certified**

AMETEK Denmark A/S was ISO-9001 certified in September 1994 by Bureau Veritas Certification Denmark.

## **CE-label**



Your new multi-scanner bears the CE label and conforms to the EMC Directive.

## **Technical assistance**

Please contact the dealer from whom you acquired the instrument if you require technical assistance.

## **Warranty**

According to current terms of sale and delivery.

This warranty only covers defects in manufacture and becomes void if the instrument has been subject to unauthorized intervention and/or misuse.

## 2.0 Safety instructions

---



### Read this manual carefully before using the instrument!

Please follow the instructions and procedures described in this manual. They are aimed at allowing you to make the best of your multi-scanner and avoid any personal injuries and/or damage to the instrument.



### Disposal – WEEE Directive

The multi-scanner contains Electrical and Electronic circuits and must be properly recycled or disposed of (in accordance with the WEEE Directive 2002/96/EC).



### Warning

The multi-scanner has been designed to calibrate and measure low voltage signals. To ensure the safety of the operator and the instrument, **DO NOT** connect the multi-scanner to input voltages above 30 Volts.

#### To avoid possible electric shock or personal injury:

- The multi-scanner **must not** be used for any purposes other than those described in this manual.
- **Do not** operate the multi-scanner in environments of explosive gas, vapour, or dust.
- **Do not** apply more than the rated voltage. See specifications for supported ranges.
- Select the proper function and range for your measurement.
- **Do not** use the multi-scanner if it operates abnormally. Protection may be impaired. When in doubt, get the multi-scanner serviced.
- Disconnect test leads before changing to another measure or source function.

- During set-up, make sure that there is correlation between the software set-up, and the actual distribution of the sensors connected to the multi-scanner. The software cannot detect misplacements of sensors.
- When servicing the multi-scanner, only use specified replacement parts.



## Caution...

**To avoid possible damage to the multi-scanner or to the equipment under test:**

- Disconnect the power and discharge all high-voltage capacitors before testing resistance or continuity.
- Use the proper connectors, function and range for your measurement.
- When using the switch test function, make sure that no other equipment, such as heavy loads or sources, is connected in the test loop.



## Note...

The product liability **only** applies if the instrument is subject to a manufacturing defect. This liability becomes void if the user fails to follow the maintenance instructions described in this manual or uses unauthorized spare parts.



# 3.0 Receiving the multi-scanner

---

## When you receive the instrument...

- Unpack and check the multi-scanner and the accessories carefully.
- Check the parts according to the list shown below.

If any of the parts are missing or damaged, please contact the dealer who sold you the multi-scanner.

### You should receive:

- 1 multi-scanner
- 

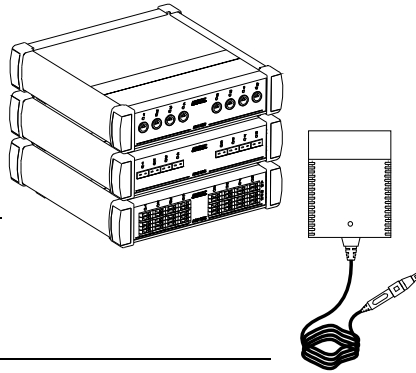

- 1 power supply
- 

- 1 traceable certificate
- 

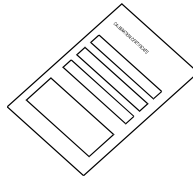

- 1 reference manual
- 

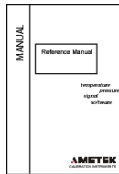

- 1 screw driver (ASM-801 only)
- 

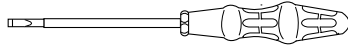

- 1 RS 232 serial cable
- 

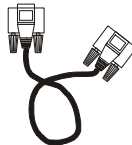

- 1 CD-ROM containing the software package “JOFRACAL”.



When reordering, please specify the part numbers according to the list of accessories, section. 11.0

### 3.1 Multi-scanner models

The Advanced Signal Multi-scanner is available in 3 different models; 801, 802 and 803 in two different model versions – A and B.

#### Model ASM-801 with Multi input

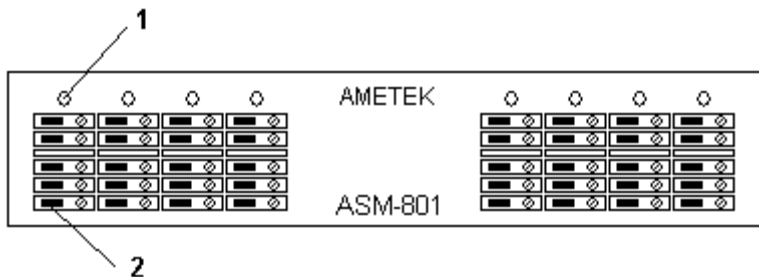

#### Model ASM-802 with Mini-Thermocouple input

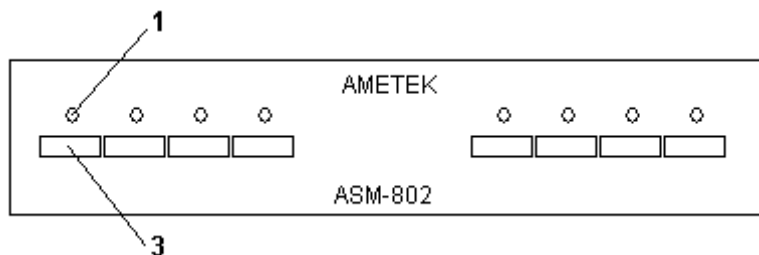

#### Model ASM-803 with LEMO input

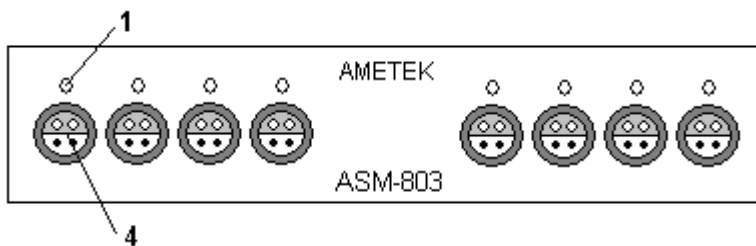

Pos.	Description
1	LED indicating which channel is being read. LED channel 1 will flash once a second when the Multi-scanner is ready for operation.
2	Screw connection, max. wire size 2,5mm <sup>2</sup> .
3	Miniature thermocouple connector from OMEGA, type SMP-U-F
4	Connector from LEMO, type ERA.1S.304.CLL

### 3.1.1 A Model version

The A version operates by connecting selected channels to a single output channel. In order to collect measurements a measuring device is connected to the output channel.

Apart from being controlled from a connected computer, the A version can also be operated manually.

Depending on the type of measuring device connected to the instrument, there is a certain settling time between channel shifts.

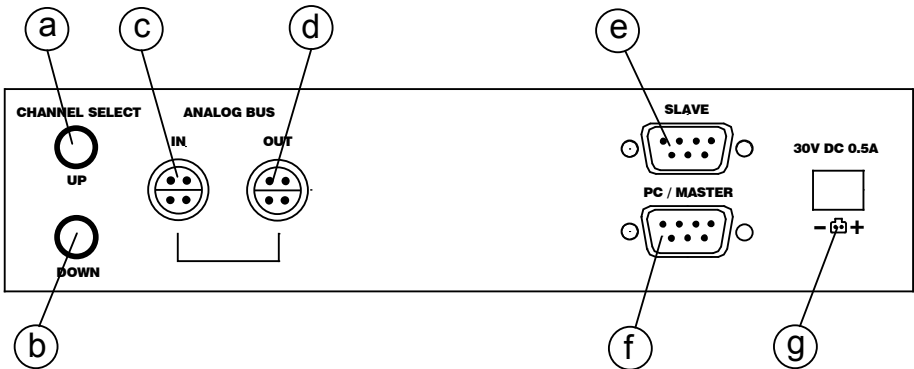

<b>Pos.</b>	<b>Description</b>
<b>a</b>	Manual channel select; UP.
<b>b</b>	Manual channel select; DOWN Holding down a and b will reset the instrument.
<b>c</b>	ANALOG BUS IN. If multiple multi-scanners are connected in series, the analogue line out of the next instrument must be connected here. For applications, see section 4.3.
<b>d</b>	ANALOG BUS OUT. Connect the measuring device here or if multiple multi-scanners are connected in series, connect the instrument in front to the ANALOG BUS OUT.
<b>e</b>	SLAVE. If multiple multi-scanners are connected in series, the RS232 master line of the succeeding instrument must be connected here. For applications, see section 4.3.
<b>f</b>	PC/Master. Connect the controlling computer here, or if multiple multi-scanners are connected in series, connect the instrument in front to the PC/MASTER.
<b>g</b>	30V DC 0.5A. Power supply connection. Use only mains adapter supplied by AMETEK in order to comply with the requirements in EN61326 (1997).

### 3.1.2 B Model version

The B version has the same functions as the A version, but it differs as it is not necessary to include a measuring instrument to the set-up, as the multi-scanner has built-in measuring capabilities.

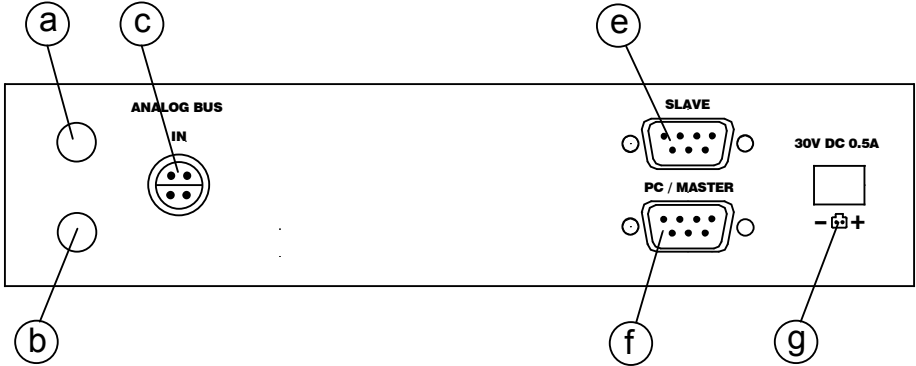

Pos.	Description
<b>a + b</b>	Holding down a and b will reset the instrument.
<b>c</b>	ANALOG BUS IN. If multiple multi-scanners are connected in series, the analogue line out of the next instrument must be connected here. For applications, see section 4.3.
<b>e</b>	SLAVE. If multiple multi-scanners are connected in series, the RS232 master line of the succeeding instrument must be connected here. For applications, see section 4.3.
<b>f</b>	PC/Master. Connect the controlling computer here or if multiple multi-scanners are connected in series, connect the instrument in front to the PC/MASTER.
<b>g</b>	30V DC 0.5A. Power supply connection. Use only mains adapter supplied by AMETEK in order to comply with the requirements in EN61326 (1997).

## 4.0 Setting up the multi-scanner

---



### Warning

- The multi-scanner **must not** be used for any purposes other than those described in this manual.
- **Do not** connect the multi-scanner to input voltages above 30 Volts.
- **Do not** operate the multi-scanner in environments of explosive gas, vapour, or dust.
- **Do not** apply more than the rated voltage/current. See specifications for supported ranges.
- Select the proper function and range for your measurement.



### Caution...

In case of resistive measurements, it is very important that no capacities are present in the circuit loop. If present, they must be discharged, before wires are connected to the instrument.

When commencing the switch test, which is in fact a resistive measurement, the thermostats must not be connected to any other voltage source.

## 4.1 Preparing the multi-scanner



Connect RS232 cables and analog signal cables before the DC power is applied.

Place the multi-scanner on an even stable surface where you intend to use it. Make sure that the scanner is not subjected to temperature fluctuations e.g. draught or sunlight.



### Caution...

The multi-scanner can be set up to supply transmitters with 24V max. 27mA.

When changing the set-up from one type of sensor to another, especially when changing from transmitters to other types of sensors, make sure that the multi-scanner is reset.

The order in which the sensors are connected to the multi-scanner makes no difference. When setting up the instrument, via the control software, it is possible to choose individually which channels to use. But what matters is that there is consistency between where to connect the sensor to the instrument and what to write in the controlling software. Inconsistency would result in faulty measurements or even possible damage to the sensors.

LED channel 1 flashes once every second when the multi-scanner is ready.

A constantly lit LED indicates which channel is currently being read.

Notice that the shifting of the internal relays can be heard when setting up the multi-scanner and between channel shifts. This is not an error.



## 4.2 Connecting sensors to the multi-scanner



### Warning

Disconnect test leads before changing to another measure or source function.



### Caution...

**To avoid possible damage to the multi-scanner or to the equipment under test:**

- Disconnect the power and discharge all high-voltage capacitors before testing resistance or continuity.
- Use the proper connectors, function and range for your measurement.
- When using the switch test function, make sure that no other equipment, such as heavy loads or sources, is connected in the test loop.

For correct connection of sensors to the multi-scanner use the diagrams below.

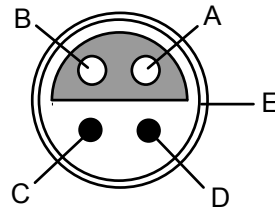
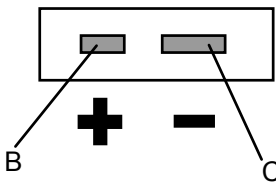
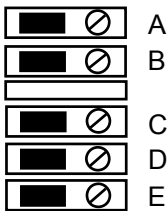

### 4.2.1 Connecting RTDs

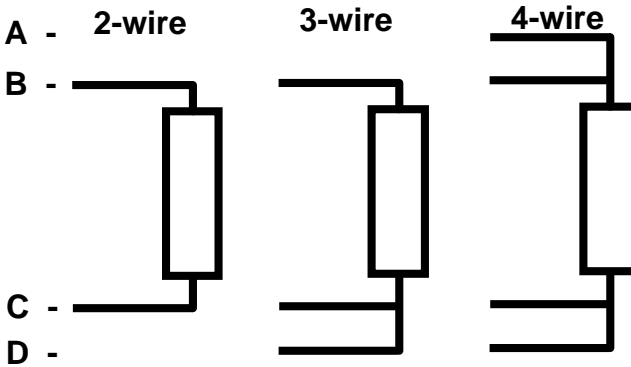

See section 10.0; Technical specifications for supported types of RTDs. The calibrator accepts 2-, 3-, and 4-wire inputs, with the 4-wire input being the most accurate.

### 4.2.2 Connecting Thermocouples and Voltages Sources

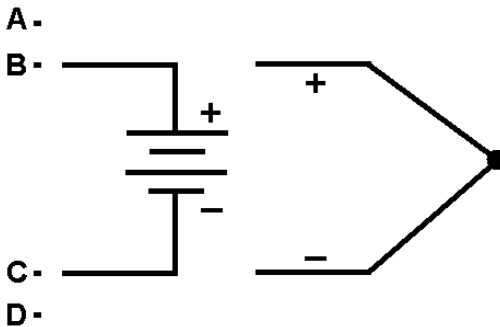

See section 10.0; Technical specifications for supported types of thermocouples. The multi-scanner has a cold junction compensation function. Normally this function should be ON and the actual temperature of the thermocouple can be measured. With CJC OFF, the multi-scanner will measure the difference between the thermocouple at the junction and at its TC input terminal.



### **Note...**

For best accuracy wait, as a minimum, 5 minutes after connecting the sensors, before any measurements are taken. **Do not** apply heat to the plugs while measuring the TC e.g. by touching them.

The multi-scanner is also able to measure the mV of a thermocouple, which can be used along with a table if the corresponding TC type is not supported by the multi-scanner.

## 4.2.3 Connecting 4-20mA Transmitters

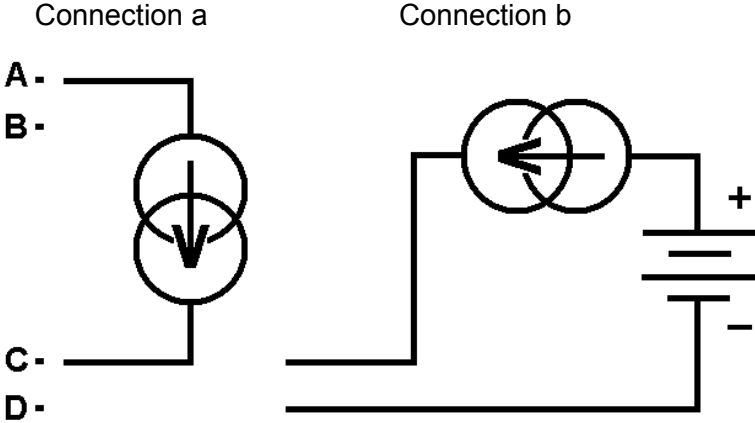

### Measuring current with loop power

In order to test a 2-wire loop powered transmitter, which is disconnected from wiring, use the loop power function. This function activates a 24V supply, in series with the current measuring. Connect as shown on figure "Connection a".

### Measuring current without loop power

Transmitters with built-in supply or transmitters using external supply are connected as shown on figure "Connection b".

### Measuring ground

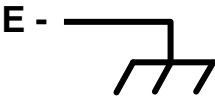

### 4.3 Cascading the multi-scanner

It is possible to connect up to 3 multi-scanners in series and build a system, which enables you to measure up to 24 sensors simultaneously.

The first multi-scanner to be placed after the PC can be either an A- or a B-model. Succeeding multi-scanners have to be A-models. It is not possible to connect multiple B-models in series.

When the DC power has been connected to the multi-scanners and the proper RS232 connection has been established between all the instruments, the LED's on channel 1 on all instruments involved will flash simultaneously.

#### First model is a B-model, succeeding multi-scanners are A-models

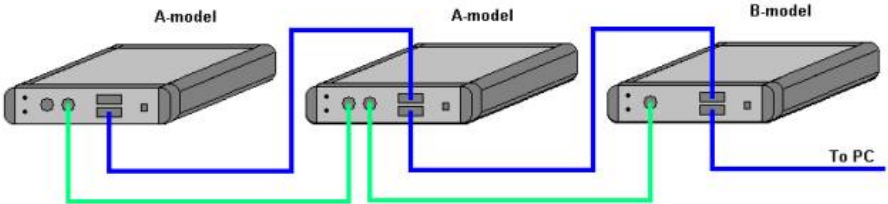

#### First model is an A-model, succeeding multi-scanners are A-models

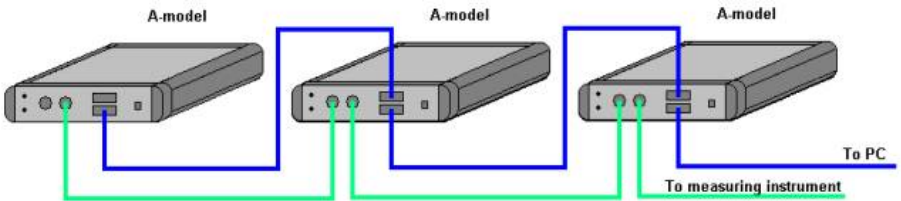

## 4.4 Connecting A-models to other instruments

The output from the ASM A-model is a LEMO ERA.1S.304.CLL connector. For correct connection to other instruments, use the diagram below.

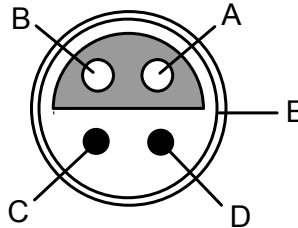

For connecting A-models to other instruments, different cables can be supplied.

Part no. 125534 Cable with male LEMO/LEMO connector can be used to connect an ASM A-model to e.g. a JOFRA DTI-1000 or JOFRA AMC-900.

Part no. 125587 Cable with mini compensation/LEMO connector can be used to connect an ASM A-model to e.g. a JOFRA ASC300, JOFRA AMC-900 JOFRA ATC-B models or other instruments with mini compensation thermocouple connectors.

Part no. 122823 Cable with banana/LEMO connector can be used to connect an ASM A-model to e.g. a JOFRA ASC300, JOFRA AMC-900, JOFRA ATC-B models or other instruments with a safety 4 mm banana sockets. For correct connection, use the diagram below.

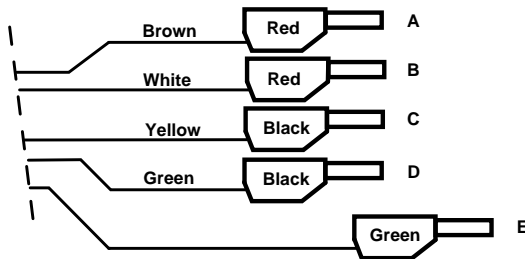

For connecting A-models to other ASM's, use 125618, cable kit.

## 5.0 Operating the multi-scanner

---



### Warning

- **Do not** use the multi-scanner if it operates abnormally. Protection may be impaired. When in doubt, get the multi-scanner serviced.
- When servicing the multi-scanner, only use specified replacement parts

## 5.1 Manual operation

### A-models

Push buttons for manual channel shift

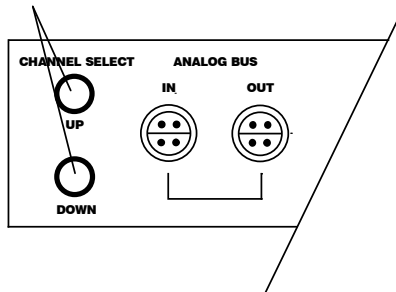

The push buttons on the back of the A-models can be used for manual channel shift. When LED 1 is flashing no channel is selected. These buttons will enable the user to operate the instrument without using a connected computer.

Supplying transmitters is not possible during manual operation.

Press both push buttons for two seconds and the multi-scanner will reset itself.

## B-models

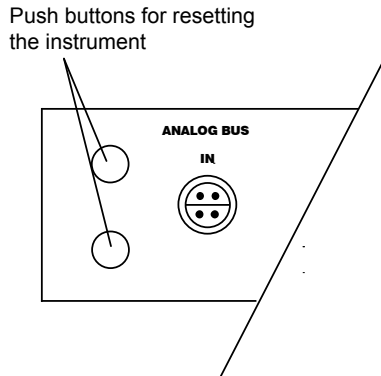

The push buttons on the back of the B-models can only be used to reset the instrument.

Press both push buttons down for two seconds and the multi-scanner will reset itself.

## 5.2 Operation with JOFRACAL

Both A- and B-models are operated by means of the sensor test and calibration software, AMETEK Denmark A/S JOFRACAL. The program is included on the enclosed CD.

For introduction and use of the program, the user is advised to read the user manual included on the CD. All possibilities and limits of the program are described in the manual.



## 6.0 Remote operation

---

The ASM can be remotely controlled using a PC terminal, or by a computer program running the calibrator in an automated system. It uses an RS-232 serial port connection for remote operation. With this connection the user can write programs on the PC, with Windows languages like Visual Basic to operate the calibrator, or use a Windows terminal, such as Hyper Terminal, to enter single commands.

### 6.1 Setting up the RS-232 Port for Remote Control

Note: The RS-232 connection cable should not exceed 15m unless the load capacitance measured at connection points is less than 2500pF.

Serial parameter values:

115200 baud

8 data bits

1 stop bit

no parity

Xon/Xoff

EOL (End of Line) character or CR (Carriage Return) or both

To set up remote operation of the calibrator on the Windows Hyper Terminal, connected to a COM port on the PC, use the following procedure:

1. Start Hyper Terminal (located in Accessories/ Communications of the Windows Start menu)
2. Select New Connection.
3. For Name enter ASM-80x. Select the serial port that the unit is connected to.
4. Enter the above information for port settings.

5. Select ASCII setup from File/Properties/Settings and mark these choices:
  - Echo typed characters locally
  - Wrap lines that exceed terminal width
6. Select Ok
7. To see if the port works enter \*IDN?. This command will return information on the unit.

## 6.2 Units

### 6.2.1 Temperature units

CEL = °C

KEL = K

FAR = °F

### 6.2.2 Electrical units

V = volts

OHMS = ohms

A = amps

Hz = Hertz

MV =  $10^{-3}V$

KOHMS =  $10^3OHMS$

## 6.3 Commands

### 6.3.1 \*CLS

SCPI standard command (Clear Status).

Clears the ESE, ESR, SRE and STB registers, i.e. set them to 0.

### 6.3.2 \*ESE <reg val>

SCPI standard command (standard Event Status Enable).

Set the Event Status Enable register, which is a 8-bit register, i.e. a value between 0 and 255 must be specified as argument

### 6.3.3 \*ESE?

SCPI standard command (standard Event Status Enable query).  
Outputs the value of the Event Status Enable register.

### 6.3.4 \*ESR?

SCPI standard command (standard Event Status Register query).  
Outputs the value of the Event Status Register.

This implementation supports the following bits in the ESR register (if enabled with the ESE register):

- Power ON (PON, bit 7): This bit is set to 1 after power up.
- Command Error (CME, bit 5): This bit is set when an unknown command has been received or a known command with wrong arguments has been received.
- EXE (bit 4): This bit is set when an error during the execution of a command has occurred.
- Operation Complete (OPC, bit 0): Is set whenever a command has been executed.

The events in the ESR register are cleared after a read.

### 6.3.5 \*IDN?

SCPI standard command (Identification query). Return information for the unit in the format <manufacture>,<model>,<serial#>,<version>,  
e.g.:

AMETEK,ASM801A,123456-12345, 1.00

### 6.3.6 \*OPC

SCPI standard command (Operation Complete).  
Because the system only implements sequential commands this command will immediately set the OPC bit in the Event Status Register when the command is executed.

### **6.3.7 \*OPC?**

SCPI standard command (Operation Complete query).  
Because the system only implements sequential commands this command will immediately output a "1" when the command is executed.

### **6.3.8 \*RST**

SCPI standard command (Reset). In this implementation the execution of this commands correspond to a power off/on.

### **6.3.9 \*SRE <reg val>**

SCPI standard command (Service Request Enable).  
Set the Service Request Enable register, which is a 8-bit register, i.e. a value between 0 and 255 must be specified as argument.

### **6.3.10 \*SRE?**

SCPI standard command (Service Request Enable query).  
Outputs the value of the Service Request Enable register.

### **6.3.11 \*STB?**

SCPI standard command (Status Byte query).  
Outputs the value of the Status Byte register. In this implementation only the ESB bit (Event Summary Bit) is used, i.e. the MAV bit (Message Available) and RQS/MSS bit is always set to 0. The ESB bit is set if one of the enabled events in the ESR register has occurred since last read of the STB register. The ESB bit is always cleared after a read.

### **6.3.12 \*TST?**

SCPI standard command (Self-Test). In this implementation no self-test is performed when executing this command, i.e. this command always return OK.

### 6.3.13 \*WAI

SCPI standard command (Wait-to-continue).

Because the system only implements sequential commands this command has no functionality.

### 6.3.14 SYSTEM\_IDN?

Returns IDN-information for all ASM-units connected in a format like the \*IDN-command. However, it is extended with the box number (first field) and calibration date (last field), e.g.:

```
1,AMETEK,ASM801B,123456-11111,0.01,2005-06-28
2,AMETEK,ASM802A,123456-22222,0.01,2005-06-28
3,AMETEK,ASM803A,123456-33333,0.01,2005-06-28
```

### 6.3.15 SYS\_CONF

SYS\_CONF <Freq.> Hz,<Speed>

<Freq> = 50, 60

<Speed> = 1,2,3,4

Sets up A/D converter speed/filters in all connected units. The speed parameter is only used by B-models. However, the speed parameter must always be specified.

Default settings at power up is 50 Hz and speed 1.

### 6.3.16 SYS\_CONF?

Returns the actual SYS\_CONF configuration.

Example 50 Hz, 3

If the connected units have different configurations "ERROR" will be returned.

### 6.3.17 TEMP\_UNIT

TEMP\_UNIT <temp. unit>  
<temp. unit> = CEL, FAR, KEL

Sets temperature unit in all connected units. Default setting at power up is CEL.

### 6.3.18 TEMP\_UNIT?

Returns temperature unit: <temp. unit> = CEL, FAR, KEL  
If the connected units have different configurations "ERROR" will be returned.

### 6.3.19 CH\_CONF

Configures the channels.

#### **CH\_CONF DCV (@<ch\_list>)**

Sets the selected for measuring voltage.

Example: CH\_CONF DCV (@2)

#### **CH\_CONF DCV, <Range low> V, <Range high> V, <Temperature low> <temp. unit>, <Temperature high> <temp. unit> (@<ch\_list>)**

Sets the selected for measuring voltage transmitter (T/V)

<Range low> = V\_LOW\_XX = 0.000 [V] (default value)

<Range high> = V\_HIGH\_XX = 10.000 [V] (default value)

<Temperature low> = V\_TEMP\_LOW\_XX = 0 [°C] (default value)

<Temperature high> = V\_TEMP\_HIGH\_XX = 100 [°C] (default value)

#### **CH\_CONF MA (@<ch\_list>)**

Sets the selected channels for measuring current

#### **CH\_CONF MA, <Range low> A, <Range high> A, <Temperature low> <temp. unit>, <Temperature high> <temp. unit> (@<ch\_list>)**

Sets the selected channels for measuring current transmitter (T/I)

<Range low> = MA\_LOW\_XX = 0.004 [A] (default value)  
<Range high> = MA\_HIGH\_XX = 0.020 [A] (default value)  
<Temperature low> = MA\_TEMP\_LOW\_XX = 0 [°C] (default value)  
<Temperature high> = MA\_TEMP\_HIGH\_XX = 100 [°C] (default value)

### **CH\_CONF MV (@<ch\_list>)**

Sets the selected for measuring mV.

### **CH\_CONF <TC type>, <CJC type>, <Manuel CJC temperature> <temp. unit>, <A>, <B>, <C> (@<ch\_list>)**

Sets the selected channels for measuring thermocouple

<TC type> can be :            J, K, T, E, R, S, B, XK, BP, L, U, N,  
                                  CUSTOM J,  
                                  CUSTOM K,  
                                  CUSTOM T,  
                                  CUSTOM E,  
                                  CUSTOM R,  
                                  CUSTOM S,  
                                  CUSTOM B,  
                                  CUSTOM XK,  
                                  CUSTOM BP,  
                                  CUSTOM L,  
                                  CUSTOM U,  
                                  CUSTOM N

<CJC type> can be : INT, EXT, MAN

<Manuel CJC temperature> is only used with <CJC type> = MAN

<A>, <B>, <C> is only used for CUSTOM types for calculating a compensated thermocouple voltage before converting to temperature:  
 $U_{comp} [V] = A + B * U_{tc}[V] + C * U_{tc}[V] * U_{tc}[V]$ .

### **CH\_CONF <RTD type>, <wires>, <Custom Serial. No.>, <R0/RTPW>, <A/ALR>, <B/BLR>, <C/C1LR>, <C2LR>, <C3LR>, <C4LR>, <C5LR>, <AHR>, <BHR>, <CHR>, <DHR>, <W660> (@<ch\_list>)**

Sets the selected channels for measuring RTD

<RTD type> can be: Ohms 400  
Ohms 4000  
CUSTOM  
CUSTOM ITS-90  
CUSTOM CvD  
P10(90)385  
P50(90)385  
P100(90)385  
P200(90)385  
P500(90)385  
P1K(90)385  
P100(90)392  
H120(90)672  
M50(90)428  
M100(90)428  
YSI(90)400

<wires> can be: 2, 3, 4

<Custom Serial. No.>, <R0/RTPW>, <A/ALR>, <B/BLR>, <C/C1LR>  
is only used for <RTD type> = Custom CvD.

<Custom Serial. No.>, <R0/RTPW>, <A/ALR>, <B/BLR>, <C/C1LR>,  
<C2LR>, <C3LR>, <C4LR>, <C5LR>, <AHR>, <BHR>, <CHR>,  
<DHR>, <W660> is only used for <RTD type> = Custom ITS-90.

<Custom Serial. No.> can be up to 16 characters.  
CUSTOM activates the stored values for either CUSTOM CVD or  
CUSTOM ITS-90.

### **CH\_CONF SWITCH (@<ch\_list>)**

Set the selected channels to be a switch sensor.

### **6.3.20 CH\_CONF? (@<channel>)**

Returns the configuration of the current channel.

- DCV  
- DCV, <Range low> V, <Range high> V, <Temperature low> <temp.  
unit>, <Temperature high> <temp. unit>



- MA
- MA, <Range low> A, <Range high> A, <Temperature low> <temp. unit> , <Temperature high> <temp. unit>
- MV
- <TC type>, <CJC type>, <Manuel CJC temperature> <temp. unit>
- <RTD type>, <wires>, <Custom Serial. No.>, <R0/RTPW>, <A/ALR>, <B/BLR>, <C/CLR>, <AHR>, <BHR>, <CHR>, <DHR>, <W660>
- SWITCH

### 6.3.21 VAL? (@<ch\_list >)

Returns the value of the selected channels. Before this command could be used the specified channels must be selected with the CH\_SCAN command. The value returned is based on the last periodic scan.

For A-models the returned value is the CJC-temperature. The value can have the following units : ohms, mV, V, mA, CEL, FAR, KEL. For sensortype = SWITCH the returned value is =0 or 1 where 1=OPEN and 0=CLOSED.

### 6.3.22 CH\_SCAN (@<ch\_list>)

Starts scanning of the selected channels.

### 6.3.23 CH\_SCAN\_STOP

Stop scanning.

### 6.3.24 CH\_SCAN?

Returns a list of the selected channels.

### 6.3.25 CAL\_DATE

Used for downloading calibration date in all units connected. The data must be in the format YYYY-MM-DD, e.g. 2005-06-28. Year must be in the range 2005..2099.

## 7.0 Maintenance

---

### 7.1 Storing

It is not necessary to store away the multi-scanner after use. The instrument can be part of a continuous set-up, as long as it is kept in a dry, clean place.

### 7.2 Cleaning



#### Caution...

Before cleaning the multi-scanner, you **must** switch it off.

Clean the outer surface of the instrument by using water and a soft cloth. A mild detergent can be used along with the water.



#### Caution...

The cloth must be firmly wrung to avoid any water penetrating the instrument and causing damage.

### 7.3 Returning the multi-scanner to service

If the multi-scanner continuously malfunctions, verify that the instrument is being operated as described in this manual and return it to the manufacturer for repair/service.

When returning the instrument please enclose a fully completed service information form. Simply copy the “Service info” form on page 36 and fill in the required information.

The multi-scanner should be returned in the original packing.

Only qualified service personnel should perform calibration, repairs, or service not covered by this manual.



### **Note...**

AMETEK Denmark's liability ceases if:

- parts are replaced/repared using spare parts, which are not identical to those recommended by the manufacturer.
- non-original parts are used in any way when operating the instrument.

AMETEK Denmark's liability is restricted to errors originated from the factory.

# Service info

**Customer data:****Date:**

Customer name and address: \_\_\_\_\_

Attention and dept.: \_\_\_\_\_

Fax no./phone no.: \_\_\_\_\_

Your order no.: \_\_\_\_\_

Delivery address: \_\_\_\_\_

Distributor name: \_\_\_\_\_

---

**Instrument data:**

Model and serial no.: \_\_\_\_\_

Warranty claimed Yes: \_\_\_ No: \_\_\_ Original invoice no.: \_\_\_\_\_

Temp. calibration

Sensor input

**Service request:****This instrument is sent for (please check off):**

\_\_\_ Calibration as left

\_\_\_ Check

\_\_\_ Calibration as found and as left

\_\_\_ Service

\_\_\_ Accredited calibration as left

\_\_\_ Repair

\_\_\_ Accredited calibration as found and as left.

---

**Diagnosis data/cause for return:**

Diagnosis/fault description: \_\_\_\_\_

Special requests: \_\_\_\_\_

---

Safety precautions: if the product has been exposed to any hazardous substances, it must be thoroughly decontaminated before it is returned to AMETEK Denmark A/S. Details of the hazardous substances and any precautions to be taken must be enclosed.

## 8.0 Errors

---



### Warning

During set-up, make sure that there is correlation between the software set-up, and the actual distribution of the sensors connected to the multi-scanner. The software cannot detect misplacements of sensors.

If the power is lost to the entire test set-up or part of it, it is highly recommended to restart the calibration.

<b>GENERAL ERRORS</b>	
<b>Error description</b>	<b>Solution</b>
LED channel 1 does not flash :	<ul style="list-style-type: none"><li>• Check the power supply</li><li>• Switch the multi-scanner off and on again</li><li>• If the error still occurs, return the multi-scanner to the manufacturer for service</li></ul>
Faulty readout :	<ul style="list-style-type: none"><li>• Check that the connected sensors are correctly connected and that they are properly polarised</li><li>• Check that the software is set up correctly</li><li>• Switch the multi-scanner off and on again</li><li>• If the error still occurs, return the multi-scanner to the manufacturer for service</li></ul>
No contact with the multi-scanner :	<ul style="list-style-type: none"><li>• Check the power supply</li><li>• Check the RS232 connection. Use only the supplied cable</li><li>• Switch the multi-scanner off and on again - and set up the software again</li><li>• If the error still occurs, return the multi-scanner to the manufacturer for service</li></ul>

	When using Hyper Terminal or similar terminal programs, and communications fails, check that the program has been set up correctly.
Faulty readout from thermocouples:	<ul style="list-style-type: none"> <li>• Check that the correct type has been selected during setup</li> <li>• Check that the sensors have been correctly polarised and connected</li> <li>• Check that the correct type of cold junction has been selected manually/automatically</li> <li>• Check that the multi-scanner is not subjected to direct or indirect heat sources</li> </ul>

<b>ERRORS – SERIES CONNECTED MULTI-SCANNERS</b>	
Error description	Solution
LED's does not flash simultaneously on all channel 1's :	<ul style="list-style-type: none"> <li>• Check the RS232 connection. Use only the supplied cables</li> <li>• Switch the multi-scanners off and on again</li> </ul>
Faulty readout :	<ul style="list-style-type: none"> <li>• Check that the connected sensors are correctly connected and that they are properly polarised</li> <li>• Check that the software is set up correctly</li> <li>• Check that analog connection between the multi-scanners has been properly established</li> <li>• Switch the multi-scanners off and on again, and set up the software again</li> </ul>

## 9.0 Adjusting the multi-scanner

---

### 9.1 Adjusting and calibrating the instrument

You are advised to return the instrument to AMETEK Denmark A/S or an accredited laboratory at least once a year for calibration and adjustment.

- Alternatively, you can calibrate/adjust the instrument yourself using the AMETRIM Adjust and Calibration Software.

### 9.2 Introduction to AMETRIM Software

This software is supplied on the JOFRACAL CD-ROM. It can be run directly from this CD-ROM and requires no special installation. It is possible to make a disk containing the AMETRIM software. From this disk AMETRIM can be installed on the hard disk of the computer, but the disk has to be in the disk drive when running the software. To use the software, you need:

#### PC hardware requirements

- IBM compatible PC with 486 or higher processor (Pentium™ 200 MHz recommended).
- 32 MB of RAM (64 MB recommended).
- 40 MB available hard-disk space.
- Standard VGA monitor (800 x 600, 256 colours), (1024 x 768 recommended).
- CD-ROM drive.
- One vacant RS 232 Serial Port.

#### PC software requirements

- Microsoft Windows®98, Microsoft Windows® NT 4.0, Microsoft Windows® 2000, Microsoft Windows® ME, Microsoft Windows® XP.
- System font: MS Sans Serif and Arial.

## 9.2.1 Installing the AMETRIM Software

The software comes on a CD-ROM and is ready to run – no installation is required. Simply insert the CD-ROM and run the ATC-adjustment program.

## 9.2.2 Connecting the PC and the ASM-80x



### Caution...

1. Ensure that both the PC and the ASM-80x are switched off at the mains. Failure to do so may result in your equipment being damaged.
2. Connect the serial cable provided to the “RS 232” port on the front of the ASM-80x and to the COM port on the PC.
3. Switch on the PC and the ASM-80x.

## 9.2.3 Starting the AMETRIM Software



### Note...

Before starting this software, the PC and the ASM-80x must be connected together and the ASM-80x switched on.



Use the normal Windows procedure to start the AMETRIM software.

If you are unsure of how to start software programs, refer to your Windows Help

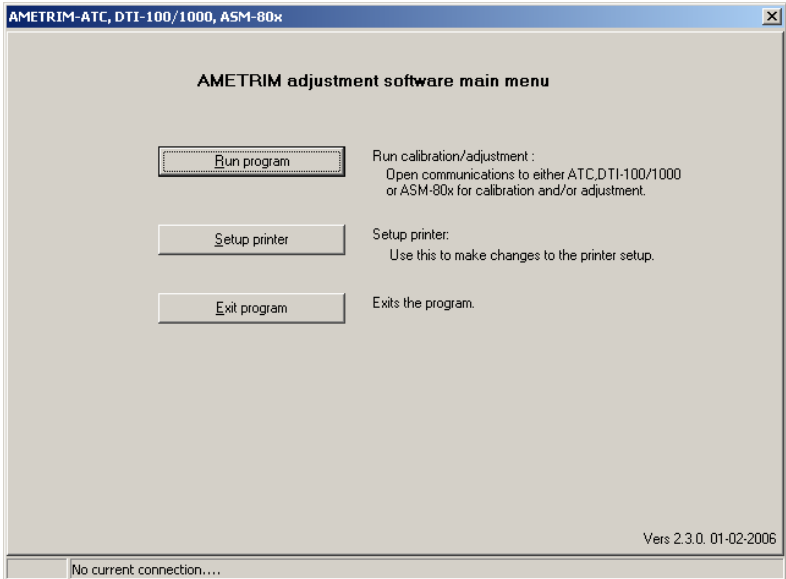

In the main menu select “Run Program” to start the calibration.

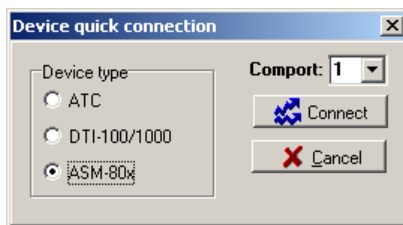

Select “ASM-80x” and “Comport” in the “Device Quick Connect” dialog box and press “Connect”.

If the ASM-80x is not switched on or is not connected to the selected port, then the software returns to the AMETRIM adjustment software main menu.

As the software starts, it detects the type of instrument connected to the PC and reads its serial number.

This information plus the COM port the calibrator is connected to is displayed at the bottom of the AMETRIM window.

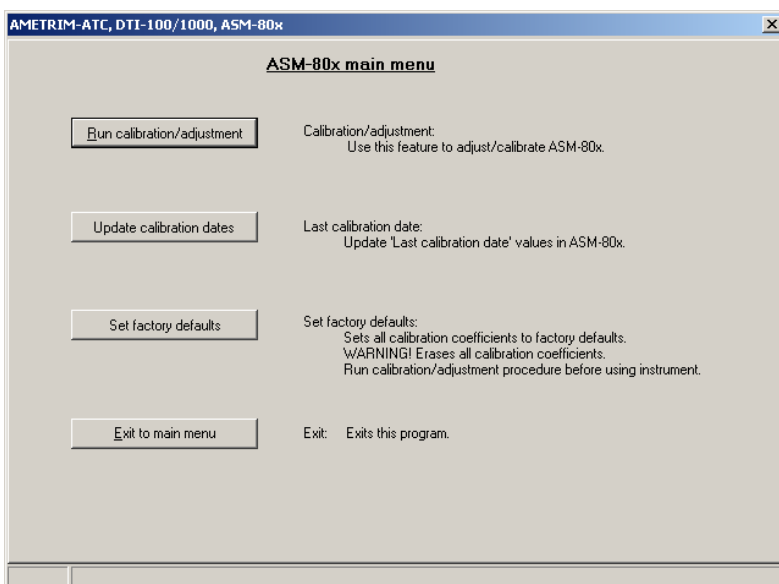

If the calibrator is not switched on or is not one of the models covered by this manual, then the software closes automatically.

## 9.2.4 Run calibration/adjustment

This option allows you to check the accuracy of the ASM-80x electrical inputs. You will require a calibrated reference signal source.

For Cold Junction compensation, you will also require a stable temperature source, for example an ice bath, and a conversion table to provide the sensor's corresponding  $\mu\text{V}$  value for the bath's temperature.



### **Note...**

Before calibrating/adjusting the inputs, the ASM-80x must have been turned on for at least half an hour.

In order to calibrate the inputs the following calibrated signals must be used:

#### **Nominal values**

#### **Accepted range**

- RTD Input:
  - 50 $\Omega$  (20 to 70 $\Omega$ )
  - 176 $\Omega$  (150 to 200 $\Omega$ )
  - 360 $\Omega$  (330 to 390 $\Omega$ )
  - 1760 $\Omega$  (1500 to 2000 $\Omega$ )
  - 3600 $\Omega$  (3300 to 3900 $\Omega$ )
- mA inputs:
  - 0 mA (-1 to +1 mA)
  - 10 mA (9 to 11 mA)
  - 20 mA (18 to 22 mA)
- V Inputs:
  - 0 V (-1 to +1 V)
  - 5 V (3 to 7 V)
  - 10 V (9 to 11 V)
- mV inputs:
  - 0 mV (-1 to +1 mV)
  - 35 mV (25 to 45 mV)
  - 70 mV (63 to 77 mV)
- Cold Junction compensation: T-type thermocouple and a reference junction, for example an ice bath.

The number and type of electrical inputs to be checked is user-definable. You can also define if you want to check the inputs by just measuring them, adjust and calibrate or to measure, adjust and then calibrate the electrical inputs.

Cold Junction compensation requires a special setup, using a calibrated thermocouple and temperature source, for example an ice bath. This and the measurement principles are shown briefly below:

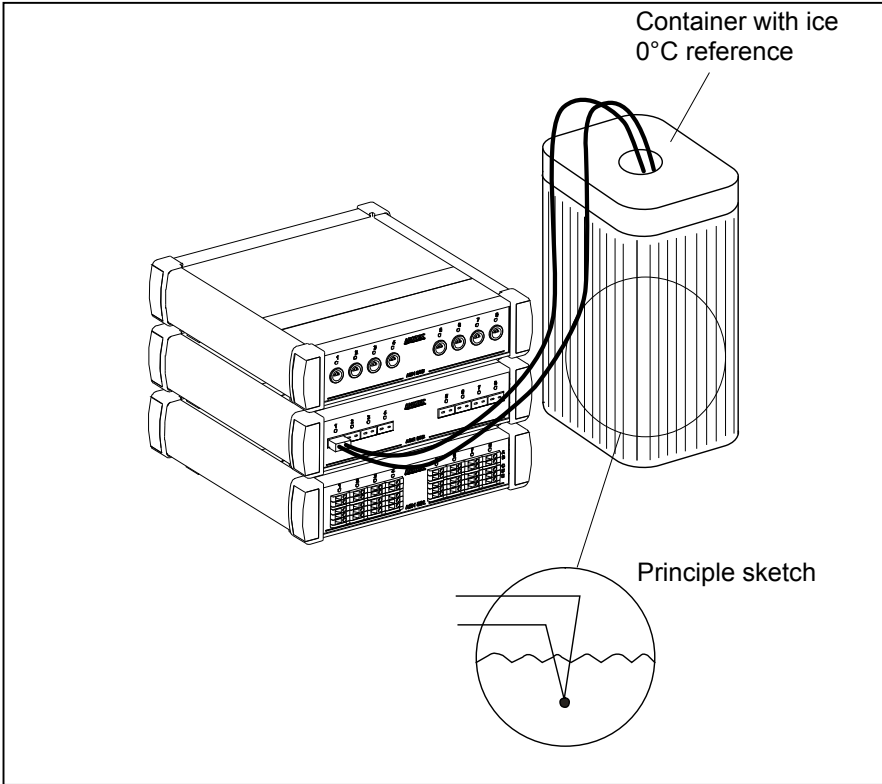

If at any point you do not wish to continue, click Stop. The software exits this option and returns to the Main Menu.



In AMETRIM main menu, click Run calibration/adjustment.

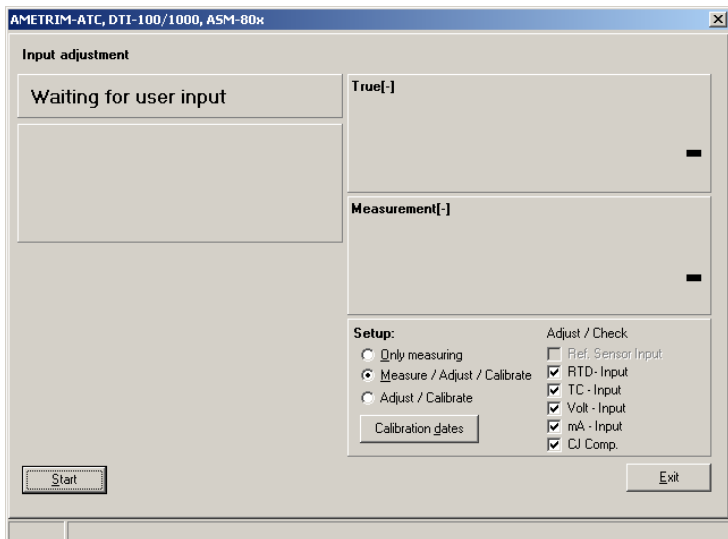

By clicking the Calibration dates button, you can view the last calibration date.

### 9.2.5 To calibrate the ASM-80x

- ☞ Click the radio button Only measuring.
- ☞ Use the check box list to select the inputs to be measured. For A-models, only CJ-Comp. Can be selected.
- ☞ Use the check box list to select the input types to be measured.
- ☞ Connect the reference signal source to the appropriate channel when prompted.
- ☞ Click Start and follow the instructions on screen.

The software starts measuring the first of the selected inputs. Ensure that the correct reference signal source is connected when prompted.

- ☞ When all the selected inputs have been measured a new dialogue appears.

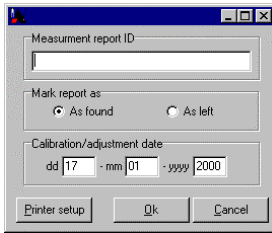

- ☞ Type a unique name for the measurements. Click As found and ensure that the date is correct. This information will appear in a measurement report displayed on screen.
- ☞ Click OK to view the measurement report.



### Note...

These results are not saved electronically. If you require a record of these measurements, click Print while it is displayed.

- ☞ When you are finished viewing or printing the report, click Close. This returns you to the first dialogue in the Temperature adjustment option.
- ☞ If you do not require any further measurements, click Done to return to the Main Menu.

## 9.2.6 To adjust and calibrate (as left) the ASM-80x



### Note...

If you select Cold Junction compensation, either you must also select the mV (TC) Input or be sure that the mV(TC) range is calibrated.

- ☞ Click the radio button Adjust/Calibrate.
- ☞ Use the check box list to select the inputs to be measured.

If you have selected more than one check box, the measurements occur in the same order as they appear in the check box list.

- ☞ Connect the reference signal source to the appropriate channel (when prompted).
- ☞ Click Start and follow the instructions on screen.

Each input has several pre-set input values. Ensure that the reference signal source is adjusted correctly when prompted.

For Cold Junction compensation, ensure the corresponding  $\mu\text{V}$  value for the calibrated junction temperature is entered ( $0\mu\text{V} @ 0^\circ\text{C}$ ).

The software measures the pre-set values for the selected input, adjusts the settings and then re-calibrates the calibrator's inputs. All this is done before moving on to the next selected input.

- ☞ When all the selected inputs have been measured, adjusted and re-calibrated a new dialogue appears.

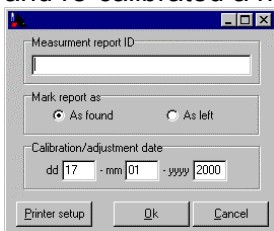

- ☞ Type a unique name for the measurements. Click As left and ensure that the date is correct. This information will appear in a measurement report displayed on screen.
- ☞ Click OK to view the measurement report.



### Note...

These results are not saved electronically. If you require a record of these measurements, click Print while the report is displayed.



When you are finished viewing or printing the report, click Close. This returns you to the first dialogue in the Temperature adjustment option.



If you do not require any further measurements, click Done to return to the Main Menu.

### 9.2.7 To calibrate (as found), adjust and calibrate (as left) the ASM-80x



#### Note...

If you select Cold Junction compensation, either you must also select the mV (TC) Input or be sure that the mV(TC) range is calibrated.



Click the radio button Measure/Adjust/Calibrate.



Use the check box list to select the inputs to be measured.

If you have selected more than one check box, the measurements occur in the same order as they appear in the check box list.



Connect the reference signal source to the appropriate channel (when prompted).



Click Start and follow the instructions on screen.

Each input has several pre-set input values. Ensure that the reference signal source is adjusted correctly when prompted.

For Cold Junction compensation, ensure the corresponding  $\mu\text{V}$  value for the calibrated junction temperature is entered ( $0\mu\text{V}$  @  $0^\circ\text{C}$ ).

The software measures the pre-set values for the selected input, adjusts the settings and then re-calibrates the calibrator's inputs. All this is done before moving on to the next selected input.





When all the selected inputs have been measured, adjusted and re-calibrated a new dialogue appears.

Measurement report ID

Mark report as

As found  As left

Calibration/adjustment date

dd 17 - mm 01 - yyyy 2000

Printer setup OK Cancel



Type a unique name for the measurements. Click As left and ensure that the date is correct. This information will appear in a measurement report displayed on screen.



Click OK to view the measurement report.



### Note...

These results are not saved electronically. If you require a record of these measurements, click Print while the report is displayed.



When you are finished viewing or printing the report, click Close. This returns you to the first dialogue in the Temperature adjustment option.



If you do not require any further measurements, click Done to return to the Main Menu.

## 9.2.8 Setup Printer

This option provides a standard Windows® procedure which enables you to edit the settings for the current printer or change to another printer.

If you are unsure how to use these settings, refer to your Windows® Help.

# 10.0 Technical specifications

---

## Input specifications<sup>1</sup>

---

<sup>1</sup> All specifications are given with an ambient temperature of  $23\pm 3^{\circ}\text{C}$  /  $73.4\pm 5.4^{\circ}\text{F}$

---

### ASM-801 B / ASM-803 B and B+A/B+A+A combinations on $\gamma$

---

Description	Value
Signal range	: 0 – 24mA
Internal power supply	: 24V, max. 28mA
Display resolution	: 0.0001mA / 0.001°C / 0.001°F
Accuracy	: $\pm(0.010\%$ of rdg. + 0.010% of F.S.)
Temperature coefficient, outside $23\pm 3^{\circ}\text{C}$ / $73.4\pm 5.4^{\circ}\text{F}$	: 7 ppm/°C
Input impedance	: $<10\Omega$

### ASM-801 B / ASM-802 B / ASM-803 B and B+A/B+A+A combinations only

---

Description	Value
Signal range	: 0 – 12V
Display resolution	: 0.0001V / 0.001°C / 0.001°F
Accuracy	: $\pm(0.005\%$ of rdg. + 0.010% of F.S.)
Temperature coefficient, outside $23\pm 3^{\circ}\text{C}$ / $73.4\pm 5.4^{\circ}\text{F}$	: 5 ppm/°C
Input impedance	: $>1\text{M}\Omega$

**ASM-801 B / ASM-802 B / ASM-803 B and B+A/B+A+A combinations only**

Description	Value
Signal range	: -10mV – 78mV
Display resolution	: 0.0001mV / 0.001°C / 0.001°F
Accuracy	: ±(0.005% of rdg. + 0.005% of F.S.)
Temperature coefficient, outside 23±3°C / 73.4±5.4°F	: 5 ppm/°C
Input impedance	: >1MΩ

**ASM-801 B / ASM-803 B and B+A/B+A+A combinations only**

Description	Value
Signal range	: 0 - 400Ω 0 - 4000Ω
Internal power supply	: Excitation current 0.8mA (0-400Ω) / 0.15mA (0-4000Ω)
Display resolution	: 0.0001Ω / 0.001°C / 0.001°F 0.001Ω / 0.001°C / 0.001°F
Accuracy	: 0-400 Ω (PT10/PT50/PT100) 4-wire : ±(0.002% of rdg. + 0.002% of F.S.) 3-wire: ±(0.002% of rdg. + 0.002% of F.S. + 50mΩ) 2-wire: ±(0.002% of rdg. + 0.002% of F.S. + 100mΩ) 0-4000 Ω (PT500/PT1000) 4-wire : ±(0.002% of rdg. + 0.005% of F.S.) 3-wire: ±(0.002% of rdg. + 0.005% of F.S. + 50mΩ) 2-wire: ±(0.002% of rdg. + 0.005% of F.S. + 100mΩ)
Temperature coefficient, outside 23±3°C / 73.4±5.4°F	: 0 - 400Ω : 5 ppm/°C 0 - 4000Ω : 10 ppm/°C

**ASM-801 B / ASM-803 B and B+A/B+A+A combinations on  $\gamma$** 

Description	Value
Signal type	: Switch test
Signal range	: on : 0 – 1k $\Omega$ / off : >3k $\Omega$
Internal power supply	: 2.5V (open)

**A-models when used with other equipment**

Description	Value
RTD 4-wire	: 2.5 ppm rdg. (0 - 400 $\Omega$ ) 15 ppm rdg. (400 - 4000 $\Omega$ )
RTD 3-wire	: 2.5 ppm rdg. +50 m $\Omega$ (0 - 400 $\Omega$ ) 15 ppm rdg. +50 m $\Omega$ (400 - 4000 $\Omega$ )
mA	: 1 ppm rdg. (0 – 24mA)
mV, V	: 2 $\mu$ V

**All models**

Description	Value
Accuracy automatic cold Junction compensation;	
ASM-801/802 A/B	: $\pm 0.20^{\circ}\text{C}$ ( $\pm 0.36^{\circ}\text{F}$ ) @ ambient temp. 20 $^{\circ}\text{C}$ to 26 $^{\circ}\text{C}$ (68 $^{\circ}\text{F}$ to 78.8 $^{\circ}\text{F}$ )
ASM-803 A/B	: $\pm 0.50^{\circ}\text{C}$ ( $\pm 0.9^{\circ}\text{F}$ ) @ ambient temp. 20 $^{\circ}\text{C}$ to 26 $^{\circ}\text{C}$ (68 $^{\circ}\text{F}$ to 78.8 $^{\circ}\text{F}$ )
Temperature coefficient	: 0.05 $^{\circ}\text{C}/^{\circ}\text{C}$ (0.05 $^{\circ}\text{F}/^{\circ}\text{F}$ ) outside 20 $^{\circ}\text{C}$ to 26 $^{\circ}\text{C}$

TC Type	Temperature range				12 month accuracy	
	°C		°F		°C	°F
	From	To	From	To		
<b>B</b>	250	320	482	608	1,31	2,35
	320	420	608	788	0,99	1,77
	420	660	788	1220	0,65	1,17
	660	800	1220	1472	0,56	1,01
	800	1000	1472	1832	0,44	0,78
	1000	1200	1832	2192	0,41	0,74
	1200	1400	2192	2552	0,39	0,70
	1400	1600	2552	2912	0,38	0,60
	1600	1820	2912	3308	0,40	0,72
<b>E</b>	-250	-200	-418	-328	0,74	1,34
	-200	-100	-328	-148	0,18	0,32
	-100	0	-148	32	0,09	0,17
	0	155	32	311	0,06	0,11
	155	320	311	608	0,06	0,12
	320	420	608	788	0,07	0,12
	420	660	788	1220	0,08	0,14
	660	800	1220	1472	0,09	0,16
	800	1000	1472	1832	0,10	0,19
<b>J</b>	-210	-100	-346	-148	0,23	0,41
	-100	0	-148	32	0,10	0,18
	0	155	32	311	0,08	0,14
	155	320	311	608	0,09	0,16
	320	420	608	788	0,09	0,17
	420	660	788	1220	0,09	0,17
	660	800	1220	1472	0,09	0,17
	800	1000	1472	1832	0,11	0,21
	1000	1200	1832	2192	0,13	0,23
<b>K</b>	-250	-200	-418	-328	0,94	1,69
	-200	-100	-328	-148	0,27	0,49
	-100	0	-148	32	0,14	0,24
	0	155	32	311	0,10	0,19
	155	320	311	608	0,11	0,20
	320	420	608	788	0,11	0,20
	420	660	788	1220	0,13	0,23
	660	800	1220	1472	0,14	0,24
	800	1000	1472	1832	0,15	0,28
1000	1200	1832	2192	0,17	0,31	
1200	1372	2192	2501,6	0,20	0,36	

TC Type	Temperature range				12 month accuracy	
	°C		°F		°C	°F
	From	To	From	To		
N	-250	-200	-418	-328	1,37	2,47
	-200	-100	-328	-148	0,41	0,74
	-100	0	-148	32	0,20	0,35
	0	155	32	311	0,15	0,27
	155	320	311	608	0,13	0,23
	320	420	608	788	0,12	0,22
	420	660	788	1220	0,13	0,23
	660	800	1220	1472	0,14	0,25
	800	1000	1472	1832	0,15	0,27
	1000	1200	1832	2192	0,16	0,29
	1200	1300	2192	2372	0,17	0,31
R	-50	0	-58	32	1,30	2,35
	0	155	32	311	0,78	1,40
	155	320	311	608	0,47	0,84
	320	420	608	788	0,40	0,73
	420	660	788	1220	0,39	0,70
	660	800	1220	1472	0,35	0,63
	800	1000	1472	1832	0,36	0,64
	1000	1200	1832	2192	0,34	0,61
	1200	1400	2192	2552	0,34	0,60
	1400	1600	2552	2912	0,35	0,62
	1600	1768	2912	3214,4	0,41	0,74
S	-50	0	-58	32	0,98	1,76
	0	155	32	311	0,78	1,40
	155	320	311	608	0,49	0,89
	320	420	608	788	0,45	0,81
	420	660	788	1220	0,41	0,73
	660	800	1220	1472	0,40	0,72
	800	1000	1472	1832	0,39	0,70
	1000	1200	1832	2192	0,38	0,69
	1200	1400	2192	2552	0,38	0,69
	1400	1600	2552	2912	0,39	0,71
	1600	1768	2912	3214,4	0,46	0,83
T	-250	-200	-418	-328	0,65	1,17
	-200	-100	-328	-148	0,27	0,49
	-100	0	-148	32	0,15	0,26
	0	155	32	311	0,10	0,18
	155	320	311	608	0,08	0,15
	320	400	608	752	0,08	0,14

RTD Type	Temperature				12 months accuracy	
	°C		°F		°C	°F
	From	To	From	To		
<b>PT10(90)385</b>	-200	-80	-328	-112	0,198	0,357
	-80	0	-112	32	0,210	0,378
	0	100	32	212	0,224	0,403
	100	155	212	311	0,225	0,405
	155	320	311	608	0,234	0,422
	320	420	608	788	0,250	0,450
	420	660	788	1220	0,263	0,473
	660	800	1220	1472	0,292	0,525
<b>PT50(90)385</b>	-200	-80	-328	-112	0,042	0,076
	-80	0	-112	32	0,046	0,083
	0	100	32	212	0,051	0,091
	100	155	212	311	0,052	0,093
	155	320	311	608	0,057	0,102
	320	420	608	788	0,062	0,112
	420	660	788	1220	0,069	0,124
	660	800	1220	1472	0,078	0,141
<b>PT100(90)385</b>	-200	-80	-328	-112	0,023	0,041
	-80	0	-112	32	0,026	0,046
	0	100	32	212	0,029	0,052
	100	155	212	311	0,030	0,054
	155	320	311	608	0,034	0,062
	320	420	608	788	0,038	0,069
	420	660	788	1220	0,044	0,080
	660	800	1220	1472	0,052	0,093
<b>PT200(90)385</b>	-200	-80	-328	-112	0,247	0,445
	-80	0	-112	32	0,262	0,471
	0	100	32	212	0,278	0,500
	100	155	212	311	0,279	0,502
	155	320	311	608	0,290	0,522
	320	420	608	788	0,309	0,556
	420	660	788	1220	0,323	0,582
	660	800	1220	1472	0,358	0,645
<b>PT500(90)385</b>	-200	-80	-328	-112	0,101	0,182
	-80	0	-112	32	0,108	0,194
	0	100	32	212	0,116	0,208
	100	155	212	311	0,117	0,210
	155	320	311	608	0,123	0,222
	320	420	608	788	0,133	0,239
	420	660	788	1220	0,141	0,254
	660	800	1220	1472	0,158	0,285

RTD Type	Temperature				12 months accuracy	
	°C		°F		°C	°F
	From	To	From	To		
<b>PT1000(90)385</b>	-200	-80	-328	-112	0,052	0,094
	-80	0	-112	32	0,056	0,102
	0	100	32	212	0,062	0,111
	100	155	212	311	0,063	0,113
	155	320	311	608	0,068	0,122
	320	420	608	788	0,074	0,133
	420	660	788	1220	0,081	0,145
	660	800	1220	1472	0,092	0,165
<b>Cu (M) 50(90)428</b>	-200	-80	-328	-112	0,039	0,070
	-80	0	-112	32	0,042	0,076
	0	100	32	212	0,045	0,081
	100	155	212	311	0,045	0,081
	155	200	311	392	0,046	0,083
<b>Cu (M) 100(90)428</b>	-200	-80	-328	-112	0,021	0,038
	-80	0	-112	32	0,023	0,041
	0	100	32	212	0,026	0,047
	100	155	212	311	0,026	0,047
	155	200	311	392	0,027	0,049



---

## Electrical specifications

---

### All models

Description	Value
Power supply [VAC],	
Input :	90 – 254V, 45 – 65Hz
Output :	30V $\pm$ 2% regulated DC, max. 30W
Power consumption, [VA] :	21 VA (AC) / 15W
Communication Interface,	
Standard :	RS232
Transmission rate :	115200 Baud
User interface,	
Update rate :	B-model : Scan rate 1 : 1 ch/sec. (V, mA, mV) 0.5 ch/sec. (RTD) Scan rate 2 : 2 ch/sec. (V, mA, mV) 1ch/sec. (RTD) Scan rate 3 : 3 ch/sec. (V, mA, mV) 1.5 ch/sec. (RTD) Scan rate 4 : 5 ch/sec. (V, mA, mV) 2.5 ch/sec. (RTD)

---

## Mechanical specifications

---

### All models

Description	Value
Weight	: 2.3 kg. / 5.07 lb.
Dimensions LxWxH	: 250 x 249 x 69 mm / 9.8 x 9.8 x 2.7 inch
Operating temp.	: 0 - 40°C/ 32 - 104°F
Storage temp.	: -20 - 50°C/ -4 - 122°F
Humidity range	: 0-90% Rh
Protection class	: IP30
RTD sensor types	: CUSTOM ITS-90, CUSTOM CvD, P10(90)385 P50(90)385, P100(90)385, P200(90)385, P500(90)385, P1K(90)385, P100(90)392, H120(90)672, M50(90)428, M100(90)428, YSI(90)400
TC sensor types	: B, E, J, K, L, N, R, S, T, U, BP, XK

---

## **Additional specifications - directives observed**

---

### **EMC directives 89/336 / EEC**

---

EN61326:1997/A1:2001/A2: 2001/A3:2003 : Electrical equipment for measurement, control and laboratory use – EMC requirements

EN61000-4-3:2002+A1 :	3V/m
EN61000-4-6:1996+A1:	3Vrms
EN61000-4-2:1995+A1+A2:	4kV contact / 8kV air
EN61000-4-4:1995+A1+A2:	1kV
EN61000-4-5:1995+A1:	1kV (L-N) / /2kV (L-PE, N-PE)
EN61000-4-11:1994+A1:	100%, 20ms
EN55022:1998+A1+A2:	0.15MHz – 30 MHz Class B conducted mains
EN55022:1998+A1+A2:	30MHz – 1000 MHz Class B radiated e. m. field

## 11.0 List of accessories

---

All parts listed in the list of accessories is available from the factory through our dealers.

Please contact your dealer for assistance if you require parts, which do not appear in the list.

---

### List of accessories

---

<b>Accessories</b>	<b>Part no.</b>
Alu. carrying case incl. box	125634
Reference manual	125614
Cable with banana/LEMO connection	122823
Cable (1150mm) with male LEMO/LEMO connection	125534
Cable with mini compensation/LEMO connection	125587
Cable with male LEMO/LEMO connection	125592
Screwdriver, VDE insulated, LK	125594
Kit with RS232 cable and cable (650mm) with male LEMO/LEMO connection	125618
Thermocouple male plug type K (ASM-802)	120517
Thermocouple male plug type N (ASM-802)	120514
Thermocouple male plug type T (ASM-802)	120515
Thermocouple male plug type Cu-Cu (ASM-802)	120519
Power supply ASM	125542
Loose LEMO connection with strain relief (ASM-803)	125620
4 core cable w/shield for Pt100 (ASM-803)	60E151
Edge port converter with 4 RS232 ports	125002
RS232 serial cable, 3 metres	105366
JOFRACAL PC software	124915

Visit **TRANSCAT**.com >

[sales@transcat.com](mailto:sales@transcat.com) | 800.828.1470