

# Technical Information

## Weld-in adapter, Process adapter and Flanges

### Level and pressure measurement



#### Application

The adapters and the flanges are used to connect level or pressure sensors to a vessel or a pipe.

#### Your benefits

- High-quality, corrosion resistant materials for use in aggressive media
- Versions without crevices and dead space of the weld-in adapters and the process adapters according to international hygiene regulations
- A variety of seals for application in diverse processes
- Flanges are specified according to both flange standards DIN/EN

## Table of contents

<b>Weld-in adapter - overview level</b> .....	<b>3</b>	DIN11851 DN50 .....	30
<b>Weld-in adapter and accessories - level</b> .....	<b>6</b>	<b>Flange - Overview</b> .....	<b>31</b>
G ¾", d=29 without flange .....	6	Specifications .....	31
G ¾", d=50 with flange .....	7	Versions .....	31
G ¾", d=55 with flange for flush-mounted installation .....	8	Flange Norm DIN EN 1092-1 .....	31
G 1", d=53 without flange for pipe-mounting .....	9	Height of raised face .....	32
G 1", d=60 with flange for flush-mounted installation with sealing surface .....	10	<b>Mechanical Construction</b> .....	<b>33</b>
G 1" sensor can be positioned .....	10	DIN flanges (DIN 2527) .....	33
RD 52 sensor can be positioned .....	11	PN10 .....	33
UNI D85 .....	11	PN16 .....	34
UNI D65 .....	12	PN25 .....	34
M24 D65 .....	12	PN40 .....	35
DRD DN50 (65 mm (2.56 in)) for flush-mounted installation of devices with DRD-flange ..	13	PN64 .....	35
<b>Weld-in adapter - overview pressure</b> .....	<b>14</b>	PN100 .....	36
<b>Weld-in adapter and accessories - Pressure</b> .....	<b>16</b>	EN flanges (DIN EN 1092-1) .....	37
UNI D85 .....	16	PN16 .....	37
UNI D65 .....	16	PN25 .....	37
DRD DN50 (65 mm (2.56 in)) for flush-mounted installation of devices with DRD-Flange .....	17	PN40 .....	38
G 1½" flush-mounted .....	17	PN63 .....	38
G 1", d=60 with flange for flush-mounted installation with sealing surface .....	18	PN100 .....	39
G 1" flush-mounted with metallic sealing taper .....	18	ASME-Flange (ASME B16.5 - 2013) .....	40
G ½" flush-mounted .....	19	Class 150 .....	40
<b>Welding hints</b> .....	<b>20</b>	Class 300 .....	41
Basic instructions .....	20	Class 600 .....	41
Preparation .....	20	Class 900 .....	42
Welding procedure .....	21	Class 1500 .....	42
Install measuring device .....	21	JIS flanges (B 2220) .....	43
Pressure resistance .....	22	10 K .....	43
Suitable for hygienic processes .....	22	20 K .....	43
<b>Process adapter M24 - overview level</b> .....	<b>23</b>	63 K .....	44
<b>Process connection M24 - level</b> .....	<b>24</b>	<b>Adapter flange FAU70</b> .....	<b>45</b>
Varivent F DN32 PN40 .....	24	FAU70E Version with metrical thread .....	45
Varivent N DN50 PN40 .....	24	FAU70A Version with conical thread .....	45
DIN11851 DN40 .....	25	<b>Slip-on flange FAU80</b> .....	<b>46</b>
DIN11851 DN50 .....	25	FAU80 Version slip-on flange .....	46
SMS 1½" .....	26	<b>Screw in flange FAX50</b> .....	<b>47</b>
Clamp 1½" .....	26	FAX50 universal flange DIN-ASME-JIS .....	47
Clamp 2" .....	27	G ¾", NPT ¾" .....	47
APV-Inline .....	27	G 1", NPT 1" .....	47
<b>Process adapter UNI - overview pressure</b> .....	<b>28</b>	G 1½", NPT 1½" .....	48
<b>Process adapter UNI - Pressure</b> .....	<b>29</b>	G 2", NPT 2" .....	48
Clamp 2" .....	29	Order information FAX50 .....	49
Varivent N .....	29	<b>Pressure-temperature dependencies</b> .....	<b>50</b>
DIN11851 DN40 .....	30	EN flanges .....	50
		ASME flanges .....	50
		JIS flanges .....	50



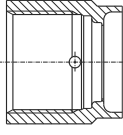
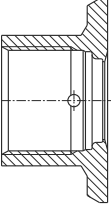
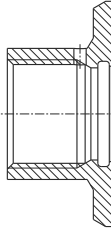
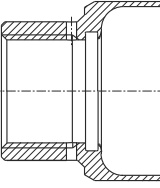
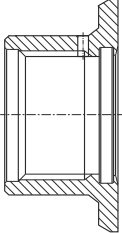
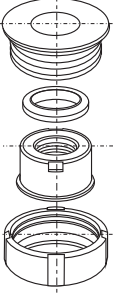

## Weld-in adapter - overview level

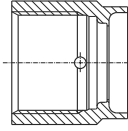
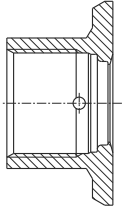
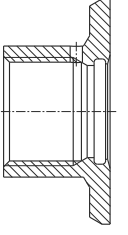
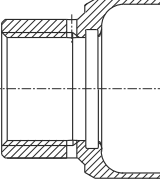
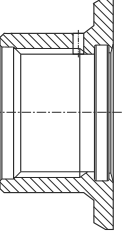
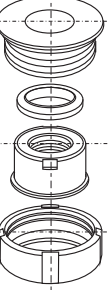
	 a0008246	 a0008251	 a0008256	 a0011924	 a0008248	 a0008253
	<b>G 3/4", d=29 without flange</b>	<b>G 3/4", d=50 with flange</b>	<b>G 3/4", d=55 with flange</b>	<b>G 1", d=53 without flange</b>	<b>G 1", d=60 with flange</b>	<b>G 1" adjustable</b>
Material	316L (1.4435)	316L (1.4435)	316L (1.4435)	316L (1.4435)	316L (1.4435)	316L (1.4435)
Roughness $\mu\text{m}$ ( $\mu\text{in}$ ) process side	$\leq 1.5$ (59.1)	$\leq 0.8$ (31.5)	$\leq 0.8$ (31.5)	$\leq 0.8$ (31.5)	$\leq 0.8$ (31.5)	$\leq 0.8$ (31.5)
Without inspection certificate EN10204-3.1 material	71258357	71258355	52001052	71258358	52001051 <sup>1)</sup>	52001221 <sup>2)</sup>
With inspection certificate EN10204-3.1 material <sup>3)</sup>	52028295	52018765	52011897	71093129	52011896 <sup>1)</sup>	52011898 <sup>2)</sup>
Seal (5 pieces) (One seal is included in scope of delivery.)	Silicone O-ring 52021717	Silicone O-ring 52021717	Silicone O-ring 52014473	Silicone O-ring 52014472	Silicone O-ring 52014472	Silicone profile gasket 52014424
Sensor dummy	-	-	71168889 <sup>4)</sup>	71166879 <sup>4)</sup>	71166879 <sup>4)</sup>	71181945 <sup>4)</sup>
<b>Measuring device</b>	<b>Option<sup>5)</sup></b>					
<b>Liquicap</b>						
FMI51	-	GQJ	-	GWJ	GWJ	-
FMI52	-	-	-	GWJ	GWJ	-
FTI51	-	GQJ	-	GWJ	GWJ	-
FTI52	-	-	-	GWJ	GWJ	-
<b>Liquipoint</b>						
FTW33	W5J	W5J	-	WSJ	WSJ	WSJ
<i>Accessories enclosed</i>	PC/PD	PA/PB	-	PG/PH	PE/PF	PG/PH

- 1) Replace the weld-in adapter with order number 917969-1000.
- 2) Replace the weld-in adapter with order number 215159-0000.
- 3) AD2000: The material 316L (in contact with process) corresponds to AD2000 - W0/W2.
- 4) TSP Modification Number. Can be ordered only FTSP, PTSP or NTSP.
- 5) The option is a component of the order code.

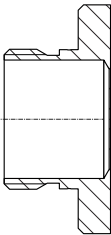
	 a0008246	 a0008251	 a0008256	 a0011924	 a0008248	 a0008253
	<b>G 3/4", d=29 without flange</b>	<b>G 3/4", d=50 with flange</b>	<b>G 3/4", d=55 with flange</b>	<b>G 1", d=53 without flange</b>	<b>G 1", d=60 with flange</b>	<b>G 1" adjustable</b>
Material	316L (1.4435)	316L (1.4435)	316L (1.4435)	316L (1.4435)	316L (1.4435)	316L (1.4435)
Roughness $\mu\text{m}$ ( $\mu\text{in}$ ) process side	$\leq 1.5$ (59.1)	$\leq 0.8$ (31.5)	$\leq 0.8$ (31.5)	$\leq 0.8$ (31.5)	$\leq 0.8$ (31.5)	$\leq 0.8$ (31.5)
Without inspection certificate EN10204-3.1 material	71258357	71258355	52001052	71258358	52001051 <sup>1)</sup>	52001221 <sup>2)</sup>
With inspection certificate EN10204-3.1 material <sup>3)</sup>	52028295	52018765	52011897	71093129	52011896 <sup>1)</sup>	52011898 <sup>2)</sup>
Seal (5 pieces) (One seal is included in scope of delivery.)	Silicone O-ring 52021717	Silicone O-ring 52021717	Silicone O-ring 52014473	Silicone O-ring 52014472	Silicone O-ring 52014472	Silicone profile gasket 52014424
Sensor dummy	-	-	71168889 <sup>4)</sup>	71166879 <sup>4)</sup>	71166879 <sup>4)</sup>	71181945 <sup>4)</sup>
<b>Measuring device</b>	<b>Option<sup>5)</sup></b>					
<b>Liquiphant</b>	<b>Option<sup>5)</sup></b>					
FTL33, FTL31	W5J	W5J	-	WSJ	WSJ	WSJ
Accessories enclosed	PC/PD	PA/PB	-	PG/PH	PE/PF	PG/PH
FTL20	1	1	-	7	7	7
FTL20H	GDJ	GDJ	-	GEJ	GEJ	GEJ
FTL260	-	-	-	0	0	-
FTL330x	-	-	-	G	G	G
FTL50, FTL50H	-	-	GQ2	GW2	GW2	GW2
FTL51, FTL51H	-	-	-	GW2	GW2	GW2
FTL80	-	-	WCJ	WSJ	WSJ	WSJ
FTL81	-	-	-	WSJ	WSJ	WSJ

- 1) Replace the weld-in adapter with order number 917969-1000.
- 2) Replace the weld-in adapter with order number 215159-0000.
- 3) AD2000: The material 316L (in contact with process) corresponds to AD2000 – W0/W2.
- 4) TSP Modification Number. Can be ordered only FTSP, PTSP or NTSP.
- 5) The option is a component of the order code.

					
	a0008252	a0008245	A0017639	a0008552	a0008254
	<b>RD52</b>	<b>Uni D85</b>	<b>Uni D65</b>	<b>M24 D65</b>	<b>DRD DN50 65 mm (2.56 in) (weld-in flange)</b>
Material	316L (1.4435)	316L (1.4435)	316L (1.4435)	316L (1.4435)	316L (1.4435) 304 (1.4301)
Roughness $\mu\text{m}$ ( $\mu\text{in}$ ) process side	$\leq 0.8$ (31.5)	$\leq 0.76$ (29.9)	$\leq 0.76$ (29.9)	$\leq 0.8$ (31.5)	$\leq 0.76$ (29.9)
Without inspection certificate EN10204-3.1 material	52001047 <sup>1)</sup>	52006262	214880-0002	71041381	52002041/ 916743-0000
With inspection certificate EN10204-3.1 material <sup>2)</sup>	52006909 <sup>1)</sup>	52010173	52010174	71041383	52011899/ -
Seal (5 pieces) (One seal is included in scope of delivery.)	Silicone profile gasket 52014424	Silicone profile gasket 52023572	Silicone profile gasket 52023572	EPDM O-ring 52024267	PTFE flat seal 52024228
Weld-in dummy	71181945 <sup>3)</sup>	71114210	71114210	-	71114209
Slotted nut	52021715	52021715	52021715	-	-
<b>Measuring device</b> <b>Liquicap</b>	<b>Option<sup>4)</sup></b>				
FMI5x	-	UPJ	UPJ	-	-
FTI5x	-	UPJ	UPJ	-	-
<b>Liquipoint</b>					
FTW33	-	-	-	X2J	-
<i>Accessories enclosed</i>	-	-	-	PM/PN	-
<b>Liquiphant</b>					
FTL33	5ZJ	-	-	X2J	-
<i>Accessories enclosed</i>	PO/PQ	-	-	PM/PN	-
FTL20H	UPJ	-	-	-	-
FTL330x	F	-	-	-	-
FTL5xH	EE2	-	-	-	PE2
<b>Levelflex</b>					
FMP41C	-	UPK/UQK	UPK/UQK	-	-
FMP43	-	-	-	U1J	-
FMP53	-	-	-	U1J	-

1) Replace the weld-in adapter with order number 942329-0001.

2) AD2000: The material 316L (in contact with process) corresponds to AD2000 – W0/W2.

3) TSP Modification Number. Can be ordered only FTSP, PTSP or NTSP.

4) The option is a component of the order code.

## Weld-in adapter and accessories - level

G 3/4", d=29 without flange

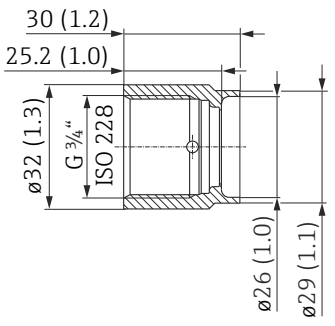
Dimensions mm (in)	Version	Order number
 <p style="text-align: center;">A0008265</p> <p>Pressure and temperature range</p> <ul style="list-style-type: none"> <li>■ max. 25 bar (362 psi) / max. 150 °C (302 °F)</li> <li>■ max. 40 bar (580 psi) / max. 100 °C (212 °F)</li> </ul>	<ul style="list-style-type: none"> <li>■ Without inspection certificate</li> <li>■ With inspection certificate EN10204-3.1 material</li> </ul> <p>Material: AISI 316L (1.4435) Roughness (process side): Ra ≤ 1.5 μm (59.1 μin)</p>	<p>71258357 52028295</p>
	<p>Silicone O-ring, ø 14.9 x 2.7 mm (0.59 x 0.11 in) Material: VMQ75, FDA</p> <ul style="list-style-type: none"> <li>■ For this version a simple replacement of the seal is possible.</li> </ul>	<p>52021717 (5 pieces)</p>
	<p>Certificate: EHEDG</p>	
	<p><b>Alternative seals</b></p>	<p><b>Order number</b></p>
	<ul style="list-style-type: none"> <li>■ ø 15.08 x 2.62 mm (0.59 x 0.10 in) Material: EPDM, FDA</li> <li>■ ø 15.08 x 2.62 mm (0.59 x 0.10 in) Material: Viton, FDA</li> <li>■ ø14.9 x 2.7mm (0.59 x 0.11 in) Material: Silicone, VMQ80, FDA, USP Class VI</li> <li>■ Pressure ring Material: 316L (1.4435)</li> <li>■ The seal with pressure ring enables easy exchange of defective sealing rings.</li> </ul>	<p>71167872<sup>1)</sup> (5 pieces)</p> <p>71167890<sup>1)</sup> (5 pieces)</p> <p>71086117 (3 pieces)</p> <p>52027421</p>

1) TSP Modification Number. Can be ordered only FTSP, PTSP or NTSP.

G 3/4", d=50 with flange

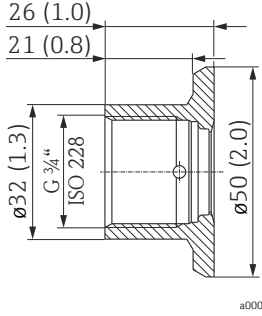
Dimensions mm (in)	Version	Order number
 <p>Pressure and temperature range</p> <ul style="list-style-type: none"> <li>max. 25 bar (362 psi) / max. 150 °C (302 °F)</li> <li>max. 40 bar (580 psi) / max. 100 °C (212 °F)</li> </ul>	<ul style="list-style-type: none"> <li>Without inspection certificate</li> <li>With inspection certificate EN10204-3.1 material</li> </ul> <p>Material: AISI 316L (1.4435) Roughness (process side): Ra ≤ 0.8 µm (31.5 µin)</p>	<p>71258355 52018765</p>
	<p>Silicone O-ring, ø 14.9 x 2.7 mm (0.59 x 0.11 in) Material: VMQ75, FDA</p> <ul style="list-style-type: none"> <li>For this version a simple replacement of the seal is possible.</li> </ul>	<p>52021717 (5 pieces)</p>
	<p>Certificate: EHEDG, 3-A</p>	
	<p><b>Alternative seals</b></p>	<p><b>Order number</b></p>
<p>ø 15.08 x 2.62 mm (0.59 x 0.10 in) Material: EPDM, FDA</p>	<p>71167872<sup>1)</sup> (5 pieces)</p>	
<p>ø 15.08 x 2.62 mm (0.59 x 0.10 in) Material: Viton, FDA</p>	<p>71167890<sup>1)</sup> (5 pieces)</p>	
<p>ø 14.9 x 2.7 mm (0.59 x 0.11 in) Material: Silicone, VMQ80, FDA, USP Class VI</p>	<p>71086117 (3 pieces)</p>	
<p>Pressure ring Material: 316L (1.4435)</p> <ul style="list-style-type: none"> <li>The seal with pressure ring enables easy exchange of defective sealing rings.</li> </ul>	<p>52027421</p>	

1) TSP Modification Number. Can be ordered only FTSP, PTSP or NTSP.

G 3/4", d=55 with flange for flush-mounted installation

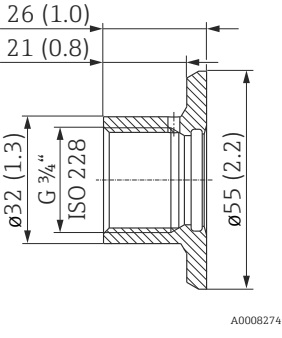
Dimensions mm (in)	Version	Order number
 <p>Pressure and temperature range</p> <ul style="list-style-type: none"> <li>max. 25 bar (362 psi) / max. 150 °C (302 °F)</li> <li>max. 40 bar (580 psi) / max. 100 °C (212 °F)</li> </ul>	<ul style="list-style-type: none"> <li>Without inspection certificate</li> <li>With inspection certificate EN10204-3.1 material</li> </ul> <p>Material: AISI 316L (1.4435) Roughness (process side): Ra ≤ 0.8 µm (31.5 µin)</p>	<p>52001052 52011897</p>
	<p>Silicone O-ring, ø 21.89 x 2.62 mm (0.86 x 0.10 in) Material: VMQ70, FDA</p>	<p>52014473 (5 pieces)</p>
	<p>Sensor dummy for welding the welding boss Material: Brass</p>	<p>71168889</p>
	<p>Certificate: EHEDG, 3-A</p>	
<p><b>Alternative seals</b> ø 21.89 x 2.62 mm (0.86 x 0.10 in)</p>	<p>Material: EPDM-70, FDA, USP Class VI</p>	<p>71140670 (3 pieces)</p>
	<p>Material: Kalrez Comp. 2035</p>	<p>71167883<sup>1)</sup></p>
	<p>Material: Viton</p>	<p>71172153<sup>1)</sup> (5er Set)</p>
	<p>Material: Viton/FEP-FEK 75 Shore</p>	<p>71167747<sup>1)</sup></p>
	<p>Material: Silicone, VMQ23-70, FDA, USP Class VI</p>	<p>71086100 (3 pieces)</p>

1) TSP Modification Number. Can be ordered only FTSP, PTSP or NTSP.

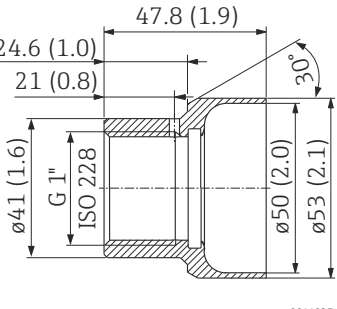

**G 1", d=53 without flange for pipe-mounting**

Dimensions mm (in)	Version	Order number
 <p>Pressure and temperature range</p> <ul style="list-style-type: none"> <li>▪ max. 25 bar (362 psi) / max. 150 °C (302 °F)</li> <li>▪ max. 40 bar (580 psi) / max. 100 °C (212 °F)</li> </ul>	<ul style="list-style-type: none"> <li>▪ Without inspection certificate</li> <li>▪ With inspection certificate EN10204-3.1 material</li> </ul> <p>Material: AISI 316L (1.4435) Roughness (process side): Ra ≤ 0.8 µm (31.5 µin)</p>	<p>71258358 71093129</p>
	<p>Silicone O-ring, ø 28.17 x 3.53 mm (1.11 x 0.14 in) Material: VMQ70, FDA</p>	<p>52014472 (5 pieces)</p>
	<p>Sensor dummy for welding the welding boss Material: Brass</p>	<p>71166879<sup>1)</sup></p>
	<p>Certificate: EHEDG, 3-A</p>	
	<p><b>Alternative seals</b> ø 28.17 x 3.53 mm (1.11 x 0.14 in)</p>	<p><b>Order number</b></p>
	<p>Material: EPDM-70, FDA, USP Class VI</p>	<p>71140668 (3 pieces)</p>
<p>Material: Viton665, FDA</p>	<p>71182264<sup>1)</sup> (5 pieces)</p>	
<p>Material: Viton, FDA, USP Class VI, 3-A</p>	<p>71166227<sup>1)</sup></p>	
<p>Material: Kalrez comp. 4079</p>	<p>71166292<sup>1)</sup></p>	
<p>Material: Silicone, VMQ3-70, FDA, USP Class VI</p>	<p>71086102 (3 pieces)</p>	

1) TSP Modification Number. Can be ordered only FTSP, PTSP or NTSP.

G 1", d=60 with flange for flush-mounted installation with sealing surface

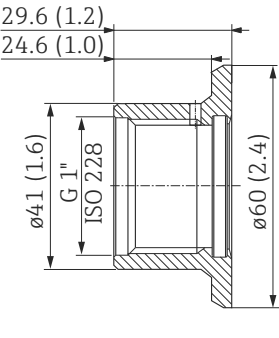
Dimensions mm (in)	Version	Order number
 <p>Pressure and temperature range</p> <ul style="list-style-type: none"> <li>max. 25 bar (362 psi) / max. 150 °C (302 °F)</li> <li>max. 40 bar (580 psi) / max. 100 °C (212 °F)</li> </ul>	<ul style="list-style-type: none"> <li>Without inspection certificate</li> <li>With inspection certificate EN10204-3.1 material</li> </ul> Material: AISI 316L (1.4435) Roughness (process side): Ra ≤ 0.8 µm (31.5 µin)	52001051 52011896
	Silicone O-ring, ø 28.17 x 3.53 mm (1.11 x 0.14 in) Material: VMQ70, FDA	52014472 (5 pieces)
	Sensor dummy for welding the welding boss Material: Brass	71166879 <sup>1)</sup>
	Certificate: EHEDG, 3-A	
	<b>Alternative seals</b> ø 28.17 x 3.53 mm (1.11 x 0.14 in)	<b>Order number</b>
	Material: EPDM-70, FDA, USP Class VI	71140668 (3 pieces)
	Material: Viton665, FDA	71182264 (5 pieces) <sup>1)</sup>
Material: Viton, FDA, USP Class VI, 3-A	71166227 <sup>1)</sup>	
Material: Kalrez comp. 4079	71166292 <sup>1)</sup>	
Material: Silicone, VMQ3-70, FDA, USP Class VI	71086102 (3 pieces)	

1) TSP Modification Number. Can be ordered only FTSP, PTSP or NTSP.

G 1" sensor can be positioned

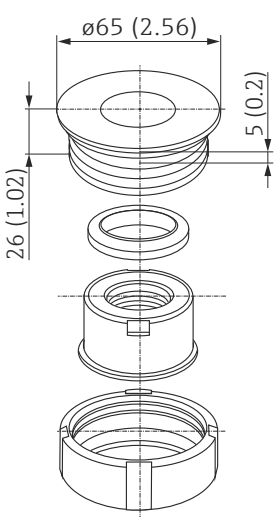
Dimensions mm (in)	Version	Order number
 <p>Pressure and temperature range</p> <ul style="list-style-type: none"> <li>max. 25 bar (362 psi) / max. 150 °C (302 °F)</li> <li>max. 40 bar (580 psi) / max. 100 °C (212 °F)</li> </ul>	<ul style="list-style-type: none"> <li>Without inspection certificate</li> <li>With inspection certificate EN10204-3.1 material</li> </ul> Material: AISI 316L (1.4435) Roughness (process side): Ra ≤ 0.8 µm (31.5 µin)	52001221 52011898
	Silicone profile gasket, ø 29 x 36 x 3.7 mm (1.14 x 1.42 x 0.15 in) Material: SI-60, FDA	52014424 (5 pieces)
	Sensor dummy for welding the welding boss Material: Brass	71181945 <sup>1)</sup>
	Certificate: EHEDG, 3-A	
	<b>Alternative seals</b> ø 29 x 36 x 3.7 mm (1.14 x 1.42 x 0.15 in)	<b>Order number</b>
	Material: EPDM-60, FDA	52012805
	Material: Silicone, VMQ60, FDA, USP Class VI	71075662 (5 pieces)

1) TSP Modification Number. Can be ordered only FTSP, PTSP or NTSP.

RD 52 sensor can be positioned

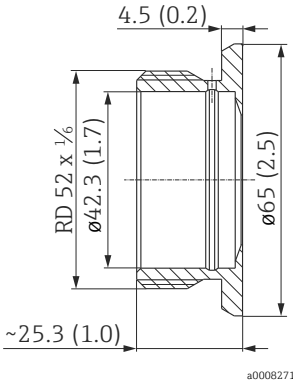
Dimensions mm (in)	Version	Order number
 <p>Pressure and temperature range</p> <ul style="list-style-type: none"> <li>max. 25 bar (362 psi) / max. 150 °C (302 °F)</li> <li>max. 40 bar (580 psi) / max. 100 °C (212 °F)</li> </ul>	<ul style="list-style-type: none"> <li>Without inspection certificate</li> <li>With inspection certificate EN10204-3.1 material</li> </ul> <p>Material: AISI 316L (1.4435) Roughness (process side): Ra ≤ 0.8 μm (31.5 μin)</p>	52001047 52006909
	<p>Silicone profile gasket, ø 29 x 36 x 3.7 mm (1.14 x 1.42 x 0.15 in) Material: SI-60, FDA</p> <ul style="list-style-type: none"> <li>For this version a simple replacement of the seal is possible.</li> </ul>	52014424 (5 pieces)
	<p>Sensor dummy for welding the welding boss Material: Brass</p>	71181945 <sup>1)</sup>
	<p><b>Alternative seals</b> ø 29 x 36 x 3.7 mm (1.14 x 1.42 x 0.15 in)</p>	<b>Order number</b>
	<p>Material: EPDM-60, FDA</p>	52012805
	<p>Material: Silicone, VMQ60, FDA, USP Class VI</p>	71075662 (5 pieces)

1) TSP Modification Number. Can be ordered only FTSP, PTSP or NTSP.

UNI D85

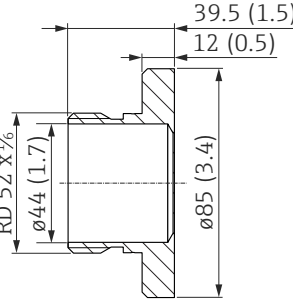
Dimensions mm (in)	Version	Order number
 <p>Pressure and temperature range</p> <ul style="list-style-type: none"> <li>max. 16 bar (232 psi) / max. 150 °C (302 °F)</li> </ul>	<ul style="list-style-type: none"> <li>Without inspection certificate</li> <li>With inspection certificate EN10204-3.1 material</li> </ul> <p>Material: AISI 316L (1.4435) Roughness (process side): Ra ≤ 0.76 μm (29.9 μin)</p>	52006262 52010173
	<p>Silicone profile gasket, ø 34 x 41.5 x 6.4 mm (1.34 x 1.63 x 0.25 in) Material: SI-60, FDA, USP Class VI-70C</p>	52023572 (5 pieces)
	<p>Sensor dummy for welding the welding boss Material: Brass</p>	71114210
	<p>Certificate: EHEDG, 3-A</p>	
	<p><b>Alternative seal</b> ø 34 x 41.5 x 6.4 mm (1.34 x 1.63 x 0.25 in)</p>	<b>Order number</b>
	<p>Profile gasket Material: EPDM-70, FDA, USP Class VI, 3-A</p>	71100719 (5 pieces)

## UNI D65

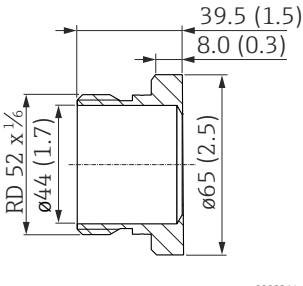
Dimensions mm (in)	Version	Order number
 <p>Pressure and temperature range</p> <ul style="list-style-type: none"> <li>max. 16 bar (232 psi) / max. 150 °C (302 °F)</li> </ul>	<ul style="list-style-type: none"> <li>Without inspection certificate</li> <li>With inspection certificate EN10204-3.1 material</li> </ul> Material: AISI 316L (1.4435) Roughness (process side): Ra ≤ 0.76 µm (29.9 µin)	214880-0002 52010174
	Silicone profile gasket ø 34 x 41.5 x 6.4 mm (1.34 x 1.63 x 0.25 in) Material: SI-60, FDA, USP Class VI-70C, 3-A	52023572 (5 pieces)
	Sensor dummy for welding the welding boss Material: Brass	71114210
	Certificate: EHEDG, 3-A	
	<b>Alternative seal</b> ø 34 x 41.5 x 6.4 mm (1.34 x 1.63 x 0.25 in)	<b>Order number</b>
Profile gasket Material: EPDM-70, FDA, USP Class VI, 3-A	71100719 (5 pieces)	

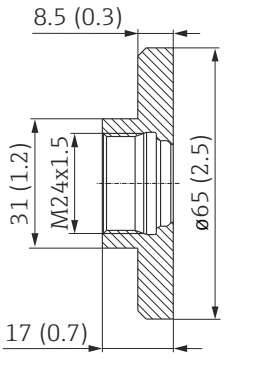

## M24 D65

Dimensions (mm)	Version	Order number
 <p>Pressure and temperature range</p> <ul style="list-style-type: none"> <li>max. 25 bar (362 psi) / max. 150 °C (302 °F)</li> </ul>	<ul style="list-style-type: none"> <li>Without inspection certificate</li> <li>With inspection certificate EN10204-3.1 material</li> </ul> Material: AISI 316L (1.4435) Roughness (process side): Ra ≤ 0.8 µm (31.5 µin)	71041381 71041383
	O-ring, ø 15.54 x 2,62 mm (0.61 x 0.1 in) Material: EPDM	52024267 (5 pieces)

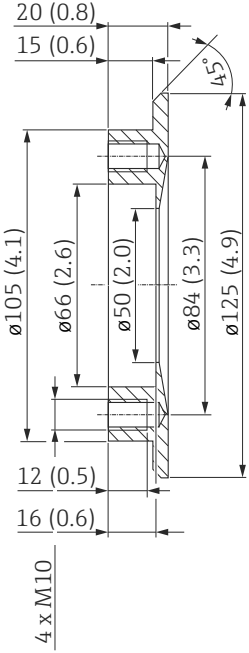
**DRD DN50 (65 mm (2.56 in))  
for flush-mounted  
installation of devices with  
DRD-flange**

Dimensions mm (in)	Version	Order number
 <p style="text-align: center;">a0008263</p> <p>Pressure and temperature range</p> <ul style="list-style-type: none"> <li>■ max. 25 bar (362 psi) / max. 150 °C (302 °F)</li> <li>■ max. 40 bar (580 psi) / max. 100 °C (212 °F)</li> </ul>	<ul style="list-style-type: none"> <li>■ Without inspection certificate</li> <li>■ With inspection certificate EN10204-3.1 material</li> </ul> <p>Material: AISI 316L (1.4435) Roughness (process side): Ra ≤ 0.76 μm (29.9 μin)</p>	<p>52002041 52011899</p>
	<p>Material: AISI 304 (1.4301) Roughness (process side): Ra ≤ 0.8 μm (31.5 μin)</p>	<p>916743-0000</p>
	<p>Flat seal, ø 50 x 65 x 1 mm (1.97 x 2.56 x 0.04 in) Material: PTFE, FDA</p>	<p>52024228 (5 pieces)</p>
	<p>Sensor dummy for welding the welding boss Material: Brass</p>	<p>71114209</p>

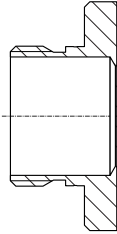
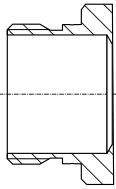

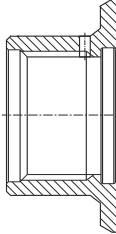
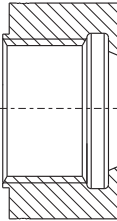
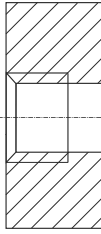
## Weld-in adapter - overview pressure

							
	a0008245	A0017639	a0008254	a0008247	a0008248	a0008249	a0008250
	<b>Uni D85</b>	<b>Uni D65</b>	<b>DRD DN50 65 mm (2.56 in) (weld-in flange)</b>	<b>G 1½" flush- mounted</b>	<b>G 1" d=60 with flange</b>	<b>G 1" flush- mounted (sealing taper)</b>	<b>G ½" flush- mounted</b>
Material	316L (1.4435)	316L (1.4435)	316L (1.4435) 304 (1.4301)	316L (1.4435)	316L (1.4435)	316L (1.4404)	316L (1.4435)
Roughness µm (µin) process side	≤ 0.76 (29.9)	≤ 0.76 (29.9)	≤ 0.76 (29.9)	≤ 0.8 (31.5)	≤ 0.8 (31.5)	≤ 0.8 (31.5)	≤ 0.8 (31.5)
Without inspection certificate EN10204-3.1 Material	52006262	214880-0002	52002041/ 916743-0000	52024469	52001051	52005087	52002643
With inspection certificate EN10204-3.1 Material <sup>1)</sup>	52010173	52010174	52011899/ -	52024470	52011896	52010171	52010172
Seal (5 pieces) (One seal is included in scope of delivery.)	Silicone profile gasket 52023572	Silicone profile gasket 52023572	PTFE flat seal 52024228	-	Silicone O-ring 52014472	-	-
Sensor dummy	71114210	71114210	71114209	52024471	71166879 <sup>2)</sup>	52005272	52005082
<b>Measuring device</b>	<b>Option<sup>3)</sup></b>						
<b>Cerabar T</b>							
PMP135	-	-	-	-	N	M	-
<b>Ceraphant T</b>							
PTP35	-	-	-	-	BB	BA	-
<b>Cerabar M</b>							
PMC45	HA	HA	KL	AG	-	-	-
PMP41	-	-	-	-	-	-	1D
PMP45	-	-	-	-	-	CD	-
PMP46	-	-	KL	-	-	-	-
PMP48	-	-	-	AG	-	-	-
PMC51	UNJ/UPJ	UNJ/UPJ	TIJ	GVJ	-	-	-
<i>Accessories enclosed</i>	Q2/Q3	QT/QU	QP/QR	QJ/QK	-	-	-
PMP51	-	-	TIJ	GVJ	GZJ	GXJ	GOJ
<i>Accessories enclosed</i>	-	-	QP/QR	QJ/QK	-	QE/QF	QA/QB

1) AD2000: The material 316L (in contact with process) corresponds to AD2000 – W0/W2.

2) TSP Modification Number. Can be ordered only FTSP, PTSP or NTSP.

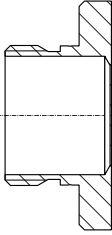
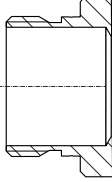
3) The option is a component of the order code.

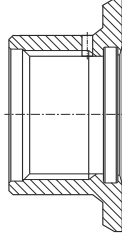
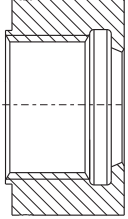
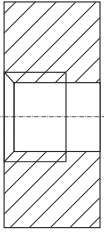
	 a0008245	 A0017639	 a0008254	 a0008247	 a0008248	 a0008249	 a0008250
	Uni D85	Uni D65	DRD DN50 65 mm (2.56 in) (weld-in flange)	G 1 1/2" flush- mounted	G 1" d=60 with flange	G 1" flush- mounted (sealing taper)	G 1/2" flush- mounted
<b>Measuring device</b>	<b>Option<sup>1)</sup></b>						
<b>Cerabar M</b>							
PMP55	UPJ	UPJ	TIJ	GVJ	-	-	-
<i>Accessories enclosed</i>	Q2/Q3	QT/QU	QP/QR	QJ/QK	-	-	-
<b>Cerabar S</b>							
PMC71	-	-	TK	1G/1H/1J	-	-	-
PMP71	-	-	-	1G/1H	-	-	-
PMP75	00	00	TK	1G/1H	-	-	-
<b>Deltapilot M</b>							
FMB50	UNJ/UPJ	UNJ/UPJ	TIJ	GGJ/GGC	-	-	-
<i>Accessories enclosed</i>	Q2/Q3	QT/QU	QP/QR	QJ/QK	-	-	-
FMB51	-	-	-	GGJ/GGC	-	-	-
<i>Accessories enclosed</i>	-	-	-	QJ/QK	-	-	-
FMB52	-	-	-	GGJ/GGC	-	-	-
<i>Accessories enclosed</i>	-	-	-	QJ/QK	-	-	-
<b>Deltapilot S</b>							
FMB70	00/01	00/01	TK	1G/1H	-	-	-
DB51	-	-	-	10/11	-	-	-
DB52	-	-	-	10/11	-	-	-
<b>Deltabar S</b>							
FMD78	-	-	TK	-	-	-	-

1) The option is a component of the order code.

## Weld-in adapter and accessories - Pressure

## UNI D85

Dimensions mm (in)	Version	Order number
	<ul style="list-style-type: none"> <li>▪ Without inspection certificate</li> <li>▪ With inspection certificate EN10204-3.1 material</li> </ul> Material: AISI 316L (1.4435) Roughness (process side): Ra ≤ 0.76 μm (29.9 μin)	52006262 52010173
	Silicone profile gasket, ø 34 x 41.5 x 6.4 mm (1.34 x 1.63 x 0.25 in) Material: SI-60, FDA, USP Class VI-70C	52023572 (5 pieces)
	Pressure sensor dummy for welding the welding boss Material: Brass	71114210
	Certificate: EHEDG, 3-A	
	<b>Alternative seals</b> ø 34 x 41.5 x 6.4 mm (1.34 x 1.63 x 0.25 in)	<b>Order number</b>
	Profile gasket Material: EPDM-70, FDA, USP Class VI, 3-A	71100719 (5 pieces)

## UNI D65

Dimensions mm (in)	Version	Order number
	<ul style="list-style-type: none"> <li>▪ Without inspection certificate</li> <li>▪ With inspection certificate EN10204-3.1 material</li> </ul> Material: AISI 316L (1.4435) Roughness (process side): Ra ≤ 0.76 μm (29.9 μin)	214880-0002 52010174
	Silicone profile gasket, ø 34 x 41.5 x 6.4 mm (1.34 x 1.63 x 0.25 in) Material: SI-60, FDA, USP Class VI-70C	52023572 (5 pieces)
	Pressure sensor dummy for welding the welding boss Material: Brass	71114210
	Certificate: EHEDG, 3-A	
	<b>Alternative seal</b> ø 34 x 41.5 x 6.4 mm (1.34 x 1.63 x 0.25 in)	<b>Order number</b>
	Profile gasket Material: EPDM-70, FDA, USP Class VI, 3-A	71100719 (5 pieces)



**DRD DN50 (65 mm (2.56 in))  
for flush-mounted  
installation of devices with  
DRD-Flange**

Dimensions mm (in)	Version	Order number
<p>a0008263</p>	<ul style="list-style-type: none"> <li>Without inspection certificate</li> <li>With inspection certificate EN10204-3.1 material</li> </ul> Material: AISI 316L (1.4435) Roughness (process side): Ra ≤ 0.76 µm (29.9 µin)	52002041 52011899
	Material: AISI 304 (1.4301) Roughness (process side): Ra ≤ 0.8 µm (31.5 µin)	916743-0000
	Flat seal, ø 50 x 65 x 1 mm (1.97 x 2.56 x 0.04 in) Material: PTFE, FDA	52024228 (5 pieces)
	Pressure sensor dummy for welding the welding boss Material: Brass	71114209

**G 1½" flush-mounted**

Dimensions mm (in)	Version	Order number
<p>a0008266</p>	<ul style="list-style-type: none"> <li>Without inspection certificate</li> <li>With inspection certificate EN10204-3.1 material</li> </ul> Material: AISI 316L (1.4435) Roughness (process side): Ra ≤ 0.8 µm (31.5 µin)	52024469 52024470
	Pressure sensor dummy for welding the welding boss Material: Brass	52024471

G 1", d=60 with flange for flush-mounted installation with sealing surface

Dimensions mm (in)	Version	Order number
	<ul style="list-style-type: none"> <li>Without inspection certificate</li> <li>With inspection certificate EN10204-3.1 material</li> </ul> Material: AISI 316L (1.4435) Roughness (process side): Ra ≤ 0.8 µm (31.5 µin)	52001051 52011896
	Silicone O-ring, ø 28.17 x 3.53 mm (1.11 x 0.14 in) Material: VMQ70, FDA	52014472 (5 pieces)
	Pressure sensor dummy for welding the welding boss Material: Brass	71166879 <sup>1)</sup>
	Certificate: EHEDG, 3-A	
	<b>Alternative seals ø 28.17 x 3.53 mm (1.11 x 0.14 in)</b>	<b>Order number</b>
	Material: EPDM-70, FDA, USP Class VI	71140668 (3 pieces)
	Material: Viton665, FDA	71182264 <sup>1)</sup> (5 pieces)
Material: Viton, FDA, USP Class VI, 3-A	71166227 <sup>1)</sup>	
Material: Kalrez comp. 4079	71166292 <sup>1)</sup>	
Material: Silicone, VMQ3-70, FDA, USP Class VI	71086102 (3 pieces)	

1) TSP Modification Number. Can be ordered only FTSP, PTSP or NTSP.

G 1" flush-mounted with metallic sealing taper

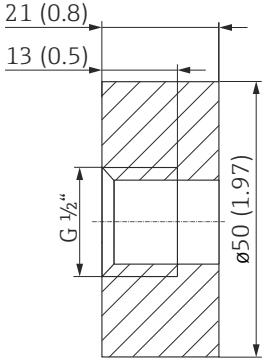

Dimensions mm (in)	Version	Order number
	<ul style="list-style-type: none"> <li>Without inspection certificate</li> <li>With inspection certificate EN10204-3.1 material</li> </ul> Material: AISI 316L (1.4435) Roughness (process side): Ra ≤ 0.8 µm (31.5 µin)	52005087 52010171
	Pressure sensor dummy for welding the welding boss Material: Brass	52005272

G 1/2" flush-mounted

Dimensions mm (in)	Version	Order number
 <p style="text-align: right; font-size: small;">a0008269</p>	<ul style="list-style-type: none"> <li>▪ Without inspection certificate</li> <li>▪ With inspection certificate EN10204-3.1 material</li> </ul> <p>Material: AISI 316L (1.4435)                      Roughness (process side): Ra ≤ 0.8 μm (31.5 μin)                      Max. pressure resistance: 100 bar (1500 psi)</p>	<p>52002643 52010172</p> <hr/> <p>Pressure sensor dummy for welding the welding boss Material: Brass</p> <p>52005082</p>

## Welding hints

### Basic instructions

-  Absolute care must be taken when welding stainless steel. The applied workpieces and tools must be rust-free. Also, no normal steel parts may be present in the vicinity.
-  During the welding, the adapter should be protected against deformations by the weld-in dummy or by other means of cooling according to usual welding practice (e.g. water cooling). With a suitable seal the weld-in dummy can also be used to flush-plug the process when starting-up the plant. Before doing so, make sure that the material of the dummy fits the process.

### Notes for pressure measuring devices

Before mounting a weld-in adapter for a pressure measuring device, please note the following:

- The maximum pressure resistance of a sensor is limited. Therefore, the welding must be performed very carefully if a weld-in adapter is applied for screwing-in a pressure measuring cell.
- In order to avoid deformations of the weld-in adapter during the welding it is essential to use the correct weld-in dummy for heat dissipation. Otherwise the tightness and pressure resistance can not be guaranteed after screwing in the sensor. The weld-in dummy prevents deformation of the weld-in adapter, which could cause leaks after the mounting of the sensor.

### Preparation

- Drill a hole at the required position into the wall of the vessel or pipe  
Hole diameter: The outer diameter of the welding adapter (max. tolerance: +0,2 mm (0,01 in))
- Slide the weld-in adapter with weld-in dummy into the hole and align it in a way as to ensure that the sensor will be positioned correctly. See the chapter "Install measuring device" from →  21.

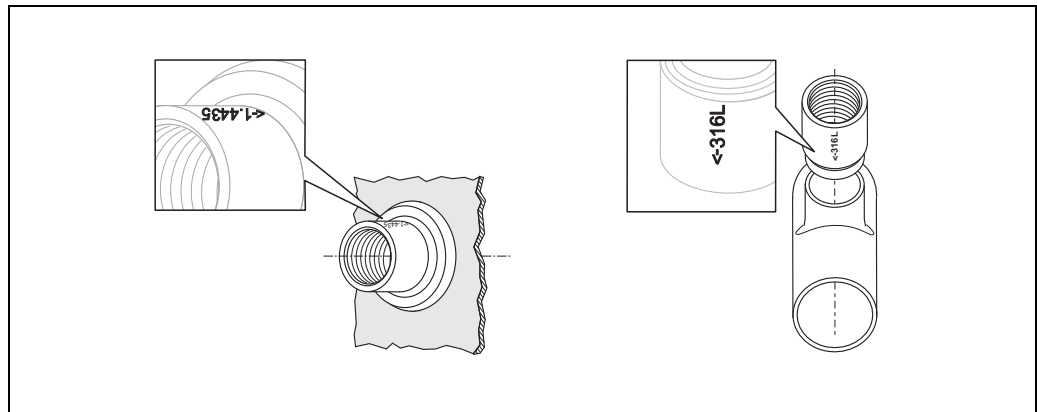

a0008868

### Weld-in adapter with leakage hole

If installed horizontally and weld-in adapters with a leakage hole are used, ensure that the leakage hole is pointing down. This allows leaks to be detected as quickly as possible.

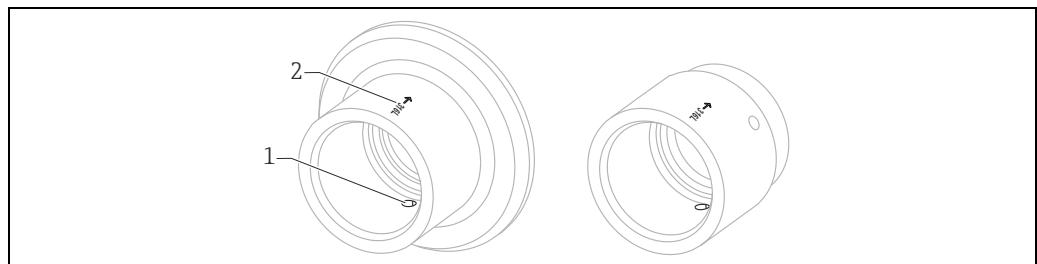

A0021912

1 Leakage hole

2 Mark, e.g. Material

**Welding procedure**

It is recommended to partition the welding seam into several segments (according to common welding practice).

- Pin the weld-in adapter with four or six welding spots to the vessel or tube (see the figures).
- Weld the segments between the spots in order to avoid deformations and leakages. After welding a segment always weld the opposite segment.
- After welding two segments stop the welding procedure until the workpiece is cooled down.
- Let the weld-in adapter cool down after the welding and remove the weld-in dummy.

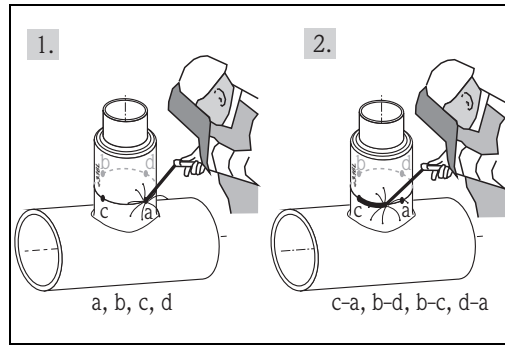

Welding of pipes

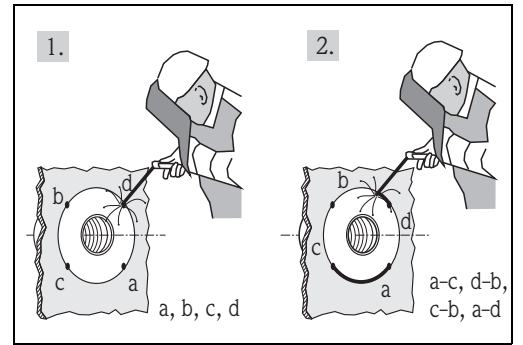

Welding of vessels



To obtain the desired surface roughness, the range of the welding seam must be polished.

**Install measuring device**

**Notes for level measuring device (e.g. Liquiphant)**

- Align the fork according to the the mark in order to prevent later deposits.

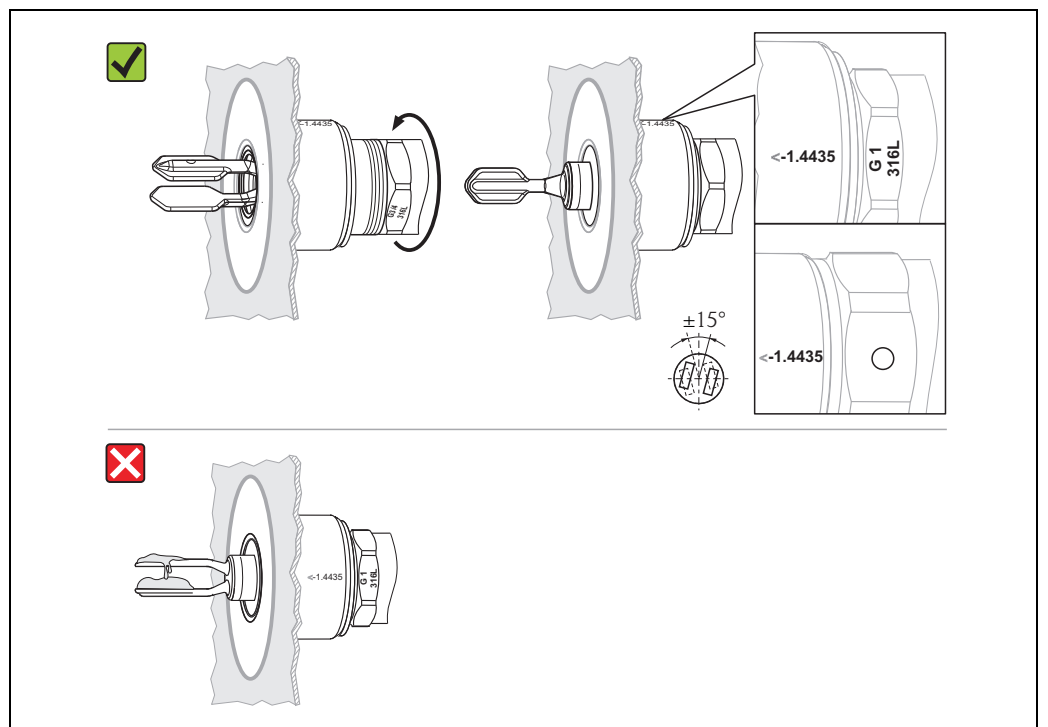

a0008871

- When mounted into pipes, the fork must be aligned in the direction of the flow according to the mark.

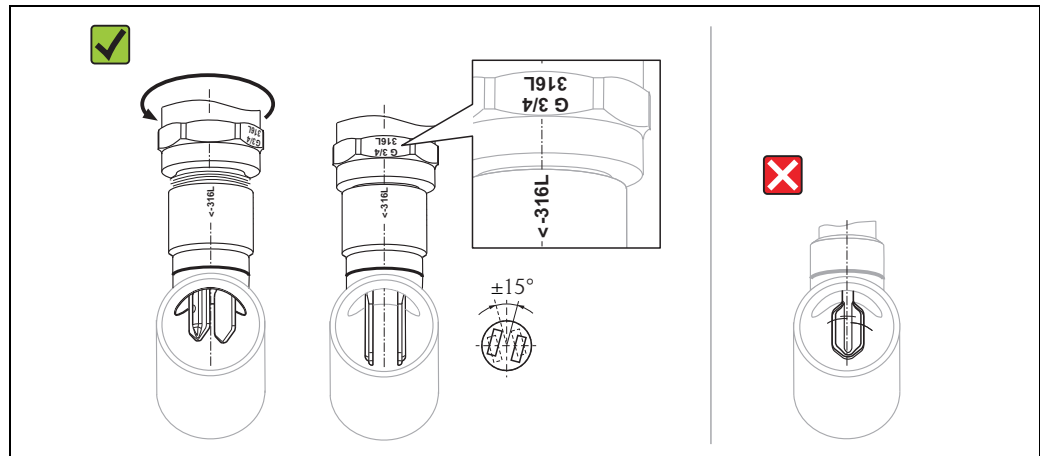

#### Notes for pressure sensor

- Before mounting, all sealing surfaces at the weld-in adapter must be cleaned.
- Remove the protective cap from the pressure sensor.
-  Do not touch or damage the diaphragm!
- Screw the pressure sensor firmly at the hexagonal nut. The threaded connection must be fastened fingertight. It is recommended to secure the threaded connection with a torque of 60 Nm ( $\pm 20$  Nm) to protect it against vibrations and other influences.

#### Pressure resistance

The material of the weld-in adapter and the quality of the welding are crucial for pressure resistance. The complete length of the thread has to be used in order to ensure maximum pressure resistance.

#### Suitable for hygienic processes

Depending of device versions meet the requirements of 3-A sanitary standard no. 74. Endress+Hauser confirms this compliance by affixing the 3-A symbol.



#### NOTICE

- For the hygienic design accordingly 3-A, EHEDG, ASME BPE is the use of appropriate fittings for pipings and gaskets should be noted.
- To avoid the risk of contamination, install the device in accordance with the design principles of EHEDG, Document 37 "Hygienic Design and Application for Sensors" and Document 16 "Hygienic Pipe Connections".
- Suitable connections and seals must be used in order to guarantee hygiene-compliant design as per 3-A and EHEDG specifications.
- The gap-free connections can be cleaned of all residue using sterilization in place (SIP) and cleaning in place (CIP), which are typical cleaning methods within the industry. Attention must be paid to the pressure and temperature specifications of the sensor and process connections for CIP and SIP processes.

## Process adapter M24 - overview level

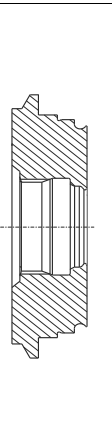
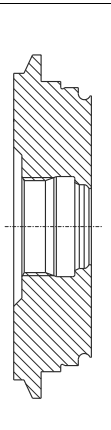
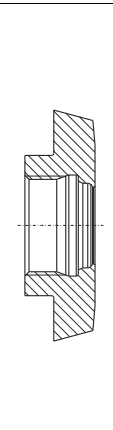
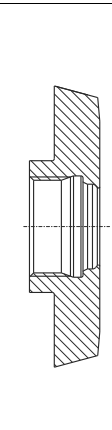
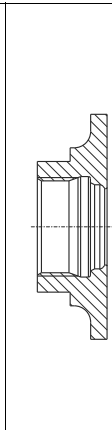
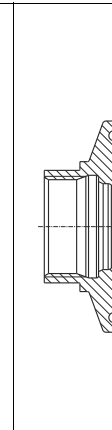
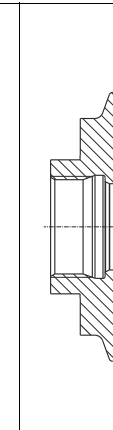
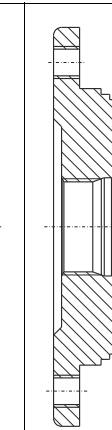
	 A0023286	 A0023419	 A0023547	 A0023418	 A0023420	 A0023423	 A0023426	 A0023422
	<b>Varivent F DN32 PN40</b>	<b>Varivent N DN50 PN40</b>	<b>DIN11851 DN40</b>	<b>DIN11851 DN50</b>	<b>SMS 1½"</b>	<b>Clamp 1½"</b>	<b>Clamp 2"</b>	<b>APV-Inline</b>
Material	316L (1.4435)	316L (1.4435)	316L (1.4435)	316L (1.4435)	316L (1.4435)	316L (1.4435)	316L (1.4435)	316L (1.4435)
Roughness $\mu\text{m}$ ( $\mu\text{in}$ ) process side	$\leq 0.8$ (31.5)	$\leq 0.8$ (31.5)	$\leq 0.8$ (31.5)	$\leq 0.8$ (31.5)	$\leq 0.8$ (31.5)	$\leq 0.8$ (31.5)	$\leq 0.8$ (31.5)	$\leq 0.8$ (31.5)
Without inspection certificate EN10204-3.1 material	52023996	52023997	52023999	52023998	52026997	52023994	52023995	52024000
With inspection certificate EN10204-3.1 material	52024003	52024004	52024006	52024005	52026999	52024001	52024002	52024007
Seal (5 pieces), (One seal is included in scope of delivery.)	EPDM 52024267	EPDM 52024267	EPDM 52024267	EPDM 52024267	EPDM 52024267	EPDM 52024267	EPDM 52024267	EPDM 52024267
Slotted nut	-	-	71258361	71258361	-	-	-	-
<b>Measuring device</b>	<b>Option<sup>1)</sup></b>							
<b>Liquipoint</b>	<b>Option<sup>1)</sup></b>							
FTW33	X2J	X2J	X2J	X2J	X2J	X2J	X2J	X2J
Accessories enclosed	RC/RD	RA/RB	-	RE/RF	RG/RH	-	-	-
<b>Liquiphant</b>	<b>Option<sup>1)</sup></b>							
FTL33	X2J	X2J	X2J	X2J	X2J	X2J	X2J	X2J
Accessories enclosed	RC/RD	RA/RB	-	RE/RF	RG/RH	-	-	-

1) The option is a component of the order code.

## Process connection M24 - level

**i** Pay attention to the temperature and pressure specifications for the seals and clips used at the customer site!

### Varivent F DN32 PN40

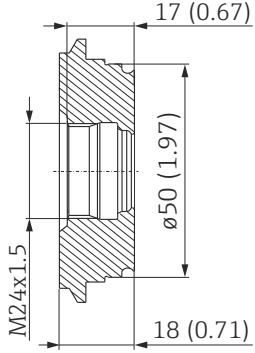
Dimensions mm (in)	Version	Order number
 <p>A0023275</p> <p>Pressure and temperature range</p> <ul style="list-style-type: none"> <li>max. 25 bar (362 psi) / max. 150 °C (302 °F)</li> <li>max. 40 bar (580 psi) / max. 100 °C (212 °F)</li> </ul>	<ul style="list-style-type: none"> <li>Without inspection certificate</li> <li>With inspection certificate EN10204-3.1 material</li> </ul> <p>Material: AISI 316L (1.4435) Roughness (process side): Ra ≤ 0.8 µm (31.5 µin)</p>	52023996 52024003
	Seal, ø 15.54 x 2.62 mm (0.61 x 0.1 in) <ul style="list-style-type: none"> <li>Material: EPDM, FDA</li> </ul>	52024267 (5 pieces)
	Certificate: EHEDG, 3-A	

### Varivent N DN50 PN40

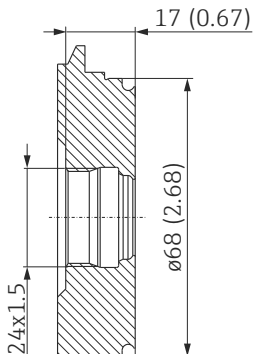
Dimensions mm (in)	Version	Order number
 <p>A0023276</p> <p>Pressure and temperature range</p> <ul style="list-style-type: none"> <li>max. 25 bar (362 psi) / max. 150 °C (302 °F)</li> <li>max. 40 bar (580 psi) / max. 100 °C (212 °F)</li> </ul>	<ul style="list-style-type: none"> <li>Without inspection certificate</li> <li>With inspection certificate EN10204-3.1 material</li> </ul> <p>Material: AISI 316L (1.4435) Roughness (process side): Ra ≤ 0.8 µm (31.5 µin)</p>	52023997 52024004
	Seal, ø 15.54 x 2.62 mm (0.61 x 0.1 in) <ul style="list-style-type: none"> <li>Material: EPDM, FDA</li> </ul>	52024267 (5 pieces)
	Certificate: EHEDG, 3-A	

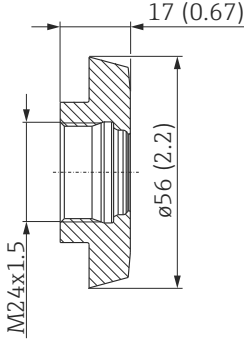

DIN11851 DN40

Dimensions mm (in)	Version	Order number
 <p data-bbox="778 667 836 680">A0023548</p> <p data-bbox="517 707 815 786">                     Pressure and temperature range                      ■ max. 25 bar (362 psi) /                      max. 150 °C (302 °F)                 </p>	<ul style="list-style-type: none"> <li>■ Without inspection certificate</li> <li>■ With inspection certificate EN10204-3.1 material</li> </ul> <p data-bbox="866 394 1318 450">                     Material: AISI 316L (1.4435)                      Roughness (process side): Ra ≤ 0.8 μm (31.5 μin)                 </p>	<p data-bbox="1361 304 1461 353">52023999 52024006</p>
	<p data-bbox="866 477 1227 504">Seal, ø 15.54 x 2.62 mm (0.61 x 0.1 in)</p> <ul style="list-style-type: none"> <li>■ Material: EPDM, FDA</li> </ul>	<p data-bbox="1361 477 1461 526">52024267 (5 pieces)</p>
	<p data-bbox="866 573 1086 600">Certificate: EHEDG, 3-A</p>	

DIN11851 DN50

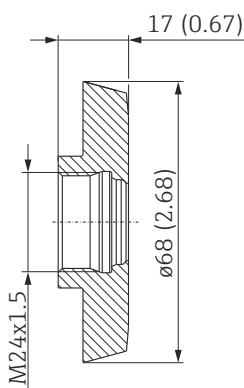
Dimensions in mm (in)	Version	Order number
 <p data-bbox="778 1377 836 1391">A0023273</p> <p data-bbox="517 1417 815 1496">                     Pressure and temperature range                      ■ max. 25 bar (362 psi) /                      max. 150 °C (302 °F)                 </p>	<ul style="list-style-type: none"> <li>■ Without inspection certificate</li> <li>■ With inspection certificate EN10204-3.1 material</li> </ul> <p data-bbox="866 1043 1318 1099">                     Material: AISI 316L (1.4435)                      Roughness (process side): Ra ≤ 0.8 μm (31.5 μin)                 </p>	<p data-bbox="1361 954 1461 1003">52023998 52024005</p>
	<p data-bbox="866 1126 1227 1153">Seal, ø 15.54 x 2.62 mm (0.61 x 0.1 in)</p> <ul style="list-style-type: none"> <li>■ Material: EPDM, FDA</li> </ul>	<p data-bbox="1361 1126 1461 1176">52024267 (5 pieces)</p>
	<p data-bbox="866 1223 1086 1249">Certificate: EHEDG, 3-A</p>	

SMS 1½"

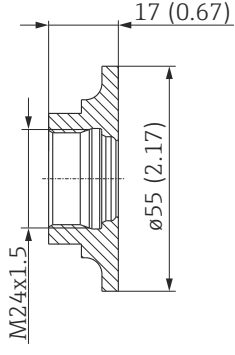
Dimensions mm (in)	Version	Order number
 <p style="text-align: right; font-size: small;">A0023278</p> <p>Pressure and temperature range</p> <ul style="list-style-type: none"> <li>■ max. 25 bar (362 psi) / max. 150 °C (302 °F)</li> </ul>	<ul style="list-style-type: none"> <li>■ Without inspection certificate</li> <li>■ With inspection certificate EN10204-3.1 material</li> </ul> <p>Material: AISI 316L (1.4435)                      Roughness (process side): Ra ≤ 0.8 µm (31.5 µin)</p>	<p>52026997 52026999</p>
	<p>Seal, ø 15.54 x 2.62 mm (0.61 x 0.1 in)</p> <ul style="list-style-type: none"> <li>■ Material: EPDM, FDA</li> </ul>	<p>52024267 (5 pieces)</p>
	<p>Certificate: 3-A</p>	

Clamp 1½"

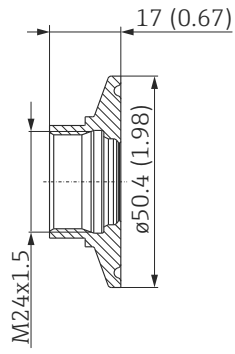
Dimensions mm (in)	Version	Order number
 <p style="text-align: right; font-size: small;">A0023284</p> <p>Pressure and temperature range</p> <ul style="list-style-type: none"> <li>■ max. 25 bar (362 psi) / max. 150 °C (302 °F)</li> <li>■ max. 40 bar (580 psi) / max. 100 °C (212 °F)</li> </ul>	<ul style="list-style-type: none"> <li>■ Without inspection certificate</li> <li>■ With inspection certificate EN10204-3.1 material</li> </ul> <p>Material: AISI 316L (1.4435)                      Roughness (process side): Ra ≤ 0.8 µm (31.5 µin)</p>	<p>52023994 52024001</p>
	<p>Seal, ø 15.54 x 2.62 mm (0.61 x 0.1 in)</p> <ul style="list-style-type: none"> <li>■ Material: EPDM, FDA</li> </ul>	<p>52024267 (5 pieces)</p>
	<p>Certificate: EHEDG, 3-A</p>	

Clamp 2"

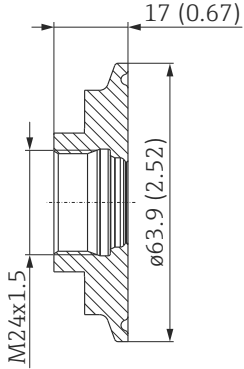
Dimensions mm (in)	Version	Order number
 <p style="text-align: right; font-size: small;">A0023281</p> <p>Pressure and temperature range</p> <ul style="list-style-type: none"> <li>■ max. 25 bar (362 psi) / max. 150 °C (302 °F)</li> <li>■ max. 40 bar (580 psi) / max. 100 °C (212 °F)</li> </ul>	<ul style="list-style-type: none"> <li>■ Without inspection certificate</li> <li>■ With inspection certificate EN10204-3.1 material</li> </ul> <p>Material: AISI 316L (1.4435) Roughness (process side): Ra ≤ 0.8 µm (31.5 µin)</p>	<p>52023995 52024002</p>
	<p>Seal, ø 15.54 x 2.62 mm (0.61 x 0.1 in)</p> <ul style="list-style-type: none"> <li>■ Material: EPDM, FDA</li> </ul>	<p>52024267 (5 pieces)</p>
	<p>Certificate: EHEDG, 3-A</p>	

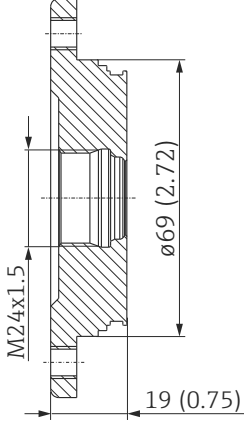

APV-Inline

Dimensions mm (in)	Version	Order number
 <p style="text-align: right; font-size: small;">A0023421</p> <p>Pressure and temperature range</p> <ul style="list-style-type: none"> <li>■ max. 25 bar (362 psi) / max. 150 °C (302 °F)</li> <li>■ max. 40 bar (580 psi) / max. 100 °C (212 °F)</li> </ul>	<ul style="list-style-type: none"> <li>■ Without inspection certificate</li> <li>■ With inspection certificate EN10204-3.1 material</li> </ul> <p>Material: AISI 316L (1.4435) Roughness (process side): Ra ≤ 0.8 µm (31.5 µin)</p>	<p>52024000 52024007</p>
	<p>Seal, ø 15.54 x 2.62 mm (0.61 x 0.1 in)</p> <ul style="list-style-type: none"> <li>■ Material: EPDM, FDA</li> </ul>	<p>52024267 (5 pieces)</p>
	<p>Certificate: EHEDG</p>	

## Process adapter UNI - overview pressure

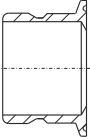

The following adapters can be used to create a connection between the customer's process connection and the Endress+Hauser instrument with a universal adapter.

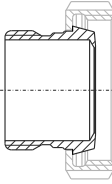
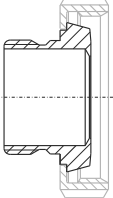
	 A0023532	 A0023530	 A0023413	 A0023417
	<b>Clamp 2"</b>	<b>Varivent N</b>	<b>DIN11851 DN40</b>	<b>DIN11851 DN50</b>
Material	316L (1.4435)	316L (1.4435)	316L (1.4435)	316L (1.4435)
Roughness $\mu\text{m}$ ( $\mu\text{in}$ ) process side	$\leq 0.76$ (29.9)	$\leq 0.76$ (29.9)	$\leq 0.76$ (29.9)	$\leq 0.76$ (29.9)
Without inspection certificate EN10204-3.1 material	71114176	71114177	71114172	71114173
With inspection certificate EN10204-3.1 material	71114207	71114208	71114178	71114205
Seal (5 pieces) (One seal is included in scope of delivery.)	Silicone profile gasket 52023572	Silicone profile gasket 52023572	Silicone profile gasket 52023572	Silicone profile gasket 52023572
Scope of delivery	-	-	Slotted nut	Slotted nut
<b>Measuring device</b>	<b>Option<sup>1)</sup></b>			
<b>Cerabar</b>	<b>Option<sup>1)</sup></b>			
PMC51	UNJ/UPJ	UNJ/UPJ	UNJ/UPJ	UNJ/UPJ
<i>Accessories enclosed</i>	RD / R4	RF/R6	RA/R1	RB/R2
<b>Deltapilot</b>	<b>Option<sup>1)</sup></b>			
FMB50	UNJ/UPJ	UNJ/UPJ	UNJ/UPJ	UNJ/UPJ
<i>Accessories enclosed</i>	RD/R4	RF/R6	RA/R1	RB/R2

1) The option is a component of the order code.

## Process adapter UNI - Pressure

### Clamp 2"

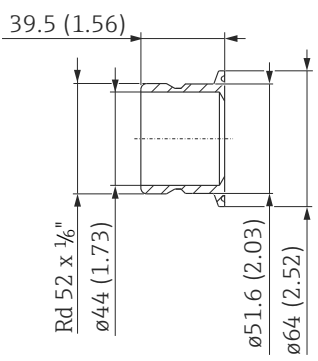
Dimensions mm (in)	Version	Order number
 <p style="text-align: center;">A0023531</p> <p>Pressure- and temperature range</p> <ul style="list-style-type: none"> <li>max. 10 bar (150 psi) / max. 100 °C (212 °F) (max. 135 °C (275 °F) for 30 minutes)</li> </ul>	<ul style="list-style-type: none"> <li>Without inspection certificate</li> <li>With inspection certificate EN10204-3.1 material</li> </ul> <p>Material: AISI 316L (1.4435) Roughness (process side): Ra ≤ 0.76 μm (29.9 μin)</p>	<p>71114176 71114207</p>
	<p>Silicone profile gasket, ø 34 x 41.5 x 6.4 mm (1.34 x 1.63 x 0.25 in) Material: SI-60, USP Class VI-70C, FDA</p>	<p>52023572 (5 pieces)</p>
	<p>Profile gasket, ø 34 x 41.5 x 6.4 mm (1.34 x 1.63 x 0.25 in) Material: EPDM-70, USP Class VI, FDA</p>	<p>71100719 (5 pieces)</p>
	<ul style="list-style-type: none"> <li>Certificate: EHEDG, 3-A</li> </ul>	

### Varivent N

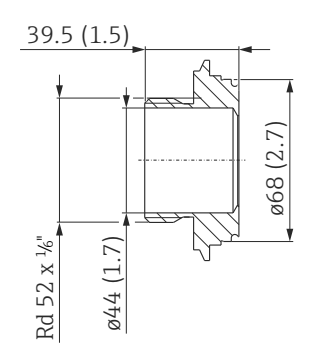
Dimensions mm (in)	Version	Order number
 <p style="text-align: center;">A0023526</p> <p>Pressure- and temperature range</p> <ul style="list-style-type: none"> <li>max. 10 bar (150 psi) / max. 100 °C (212 °F) (max. 135 °C (275 °F) for 30 minutes)</li> </ul>	<ul style="list-style-type: none"> <li>Without inspection certificate</li> <li>With inspection certificate EN10204-3.1 material</li> </ul> <p>Material: AISI 316L (1.4435) Roughness (process side): Ra ≤ 0.76 μm (29.9 μin)</p>	<p>71114177 71114208</p>
	<p>Silicone profile gasket, ø 34 x 41.5 x 6.4 mm (1.34 x 1.63 x 0.25 in) Material: SI-60, USP Class VI-70C, FDA</p>	<p>52023572 (5 pieces)</p>
	<p>Profile gasket, ø 34 x 41.5 x 6.4 mm (1.34 x 1.63 x 0.25 in) Material: EPDM-70, USP Class VI, FDA</p>	<p>71100719 (5 pieces)</p>
	<ul style="list-style-type: none"> <li>Certificate: EHEDG, 3-A</li> </ul>	

## DIN11851 DN40

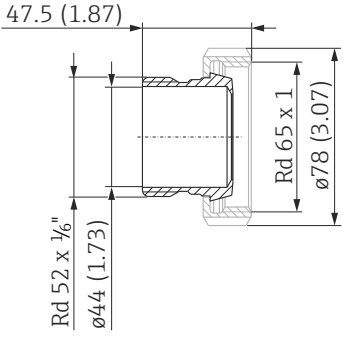
Dimensions mm (in)	Version	Order number
 <p>Pressure- and temperature range</p> <ul style="list-style-type: none"> <li>max. 10 bar (150 psi) / max. 100 °C (212 °F) (max. 135 °C (275 °F) for 30 minutes)</li> </ul>	<ul style="list-style-type: none"> <li>Without inspection certificate</li> <li>With inspection certificate EN10204-3.1 material</li> </ul> <p>Material: AISI 316L (1.4435) Roughness (process side): Ra ≤ 0.76 µm (29.9 µin)</p>	<p>71114172 71114178</p>
	<p>Material slotted nut: Endress+Hauser supplies these slotted nuts in stainless steel AISI 304 (DIN/EN material number 1.4301) or in AISI 304L (DIN/EN material number 1.4307).</p>	
	<p>Silicone profile gasket, ø 34 x 41.5 x 6.4 mm (1.34 x 1.63 x 0.25 in) Material: SI-60, USP Class VI-70C, FDA</p>	<p>52023572 (5 pieces)</p>
	<p>Profile gasket, ø 34 x 41.5 x 6.4 mm (1.34 x 1.63 x 0.25 in) Material: EPDM-70, USP Class VI, FDA</p>	<p>71100719 (5 pieces)</p>
<ul style="list-style-type: none"> <li>Certificate: EHEDG, 3-A</li> </ul>		

## DIN11851 DN50

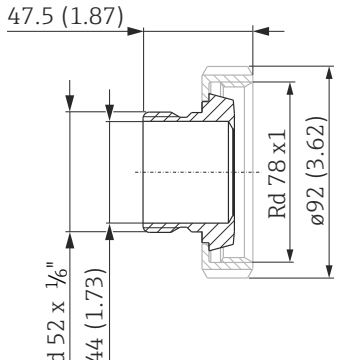
Dimensions mm (in)	Version	Order number
 <p>Pressure- and temperature range</p> <ul style="list-style-type: none"> <li>max. 10 bar (150 psi) / max. 100 °C (212 °F) (max. 135 °C (275 °F) for 30 minutes)</li> </ul>	<ul style="list-style-type: none"> <li>Without inspection certificate</li> <li>With inspection certificate EN10204-3.1 material</li> </ul> <p>Material: AISI 316L (1.4435) Roughness (process side): Ra ≤ 0.76 µm (29.9 µin)</p>	<p>71114173 71114205</p>
	<p>Material slotted nut: Endress+Hauser supplies these slotted nuts in stainless steel AISI 304 (DIN/EN material number 1.4301) or in AISI 304L (DIN/EN material number 1.4307).</p>	
	<p>Silicone profile gasket, ø 34 x 41.5 x 6.4 mm (1.34 x 1.63 x 0.25 in) Material: SI-60, USP Class VI-70C, FDA</p>	<p>52023572 (5 pieces)</p>
	<p>Profile gasket, ø 34 x 41.5 x 6.4 mm (1.34 x 1.63 x 0.25 in) Material: EPDM-70, USP Class VI, FDA</p>	<p>71100719 (5 pieces)</p>
<ul style="list-style-type: none"> <li>Certificate: EHEDG, 3-A</li> </ul>		

## Flange - Overview

### Specifications

The material of the flanges delivered is AISI 316L with the material number 1.4404 or 1.4435. With regard to their stability-temperature property, the materials 1.4404 and 1.4435 are grouped in DIN EN 1092-1 table 18 under 13E0 and in JIS B2220:2004 table 5 under 023b. The ASME flanges are dual rated flanges (316/316L) and grouped in table 2-2.2 according to ASME B16.5-2013.



Values in inches are converted to values in millimeters using the factor 2.54. The mm values are rounded off to the nearest 0 or 5 in the ASME standard.

### Versions

DIN flanges	EN flanges	ASME flanges	JIS flanges
German National Standards Institute	European Standards	America Society of Mechanical Engineers	Japanese Industrial Standard
DIN 2527	DIN EN 1092-1:2002-06 and 2007	ASME B16.5-2013	B2220:2004

### Flange Norm DIN EN 1092-1

Endress+Hauser usually delivers only flanges with flat face. This type of flange has hardly changed. Thus, a comparison is done only for this sealing surfaces. Due to the change of the designation of the sealing surface mistakes may occur occasionally. The roughness (Rz) of the old raised face form C and the new one B1 have an overlapping between 40 to 50 µm. In this roughness window both standards are fulfilled.

Therefore, at Endress+Hauser the flanges are specified according to both flange standards. This double marking makes it clear that both standards are met.

Flange	Sealing Surface	DIN 2526 <sup>1)</sup>		DIN EN 1092-1		
		Form	Rz (µm)	Form	Rz (µm)	Ra (µm)
without raised face		A B	- 40 - 160	A <sup>2)</sup>	12.5 - 50	3.2 - 12.5
with raised face		C	40 - 160	B1 <sup>3)</sup>	12.5 - 50	3.2 - 12.5
		D	40	B2	3.2 - 12.5	0.8 - 3.2
		E	16			
tongue		F	-	C	3.2 - 12.5	0.8 - 3.2
groove		N	-	D		
projection		V 13	-	E	12.5 - 50	3.2 - 12.5
recess		R 13	-	F		
projection		V 14	for O-rings	H	3.2 - 12.5	3.2 - 12.5
recess		R 14		G		

1) contained in DIN 2527

2) typically of PN2.5 bis PN40

3) typically of PN63



Flange to the old DIN standard are compatible to the new DIN EN 1092-1. Change in pressure rating: old DIN standards PN64 → DIN EN 1092-1 PN63.

**Height of raised face**

Dimensions in mm (in).

Standard	Flange	Height of raised face f	Tolerance
DIN EN 1092-1:2002-06	all types	2 (0.08)	0 -1 (-0.04)
DIN EN 1092-1:2007	≤ DN 32	2 (0.08)	0 -1 (-0.04)
	> DN 32 up to DN 250	3 (0.12)	0 -2 (-0.08)
	> DN 250 up to DN 500	4 (0.16)	0 -3 (-0.12)
	> DN 500	5 (0.19)	0 -4 (-0.16)
ASME B16.5-2013	≤ Class 300	1.6 (0.06)	±0.75 (±0.03)
	≥ Class 600	6.4 (0.25)	±0.5 (±0.02)
JIS B2220:2004	< DN 20	1.5 (0.06) 0	-
	> DN 20 up to DN 50	2 (0.08) 0	
	> DN 50	3 (0.12) 0	



## Mechanical Construction

### DIN flanges (DIN 2527)

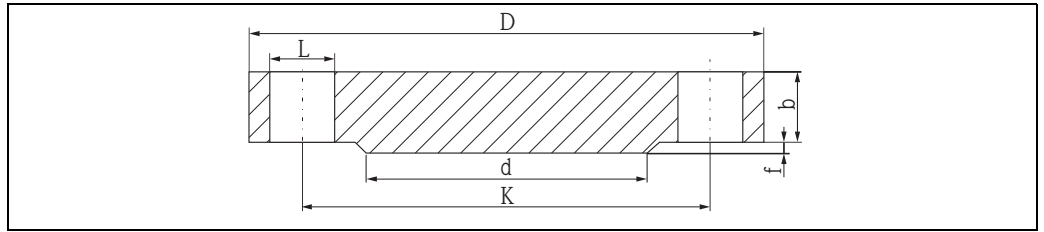

L00-flangexxx-06-xx-07-xx-002

(Raised face DIN 2526 form C)

- L Diameter of holes
- d Raised face diameter
- K Diameter of hole circle
- D Flange diameter
- b Total flange thickness
- f Raised face height (general 2 mm (0.08 in))

### PN10

In following tables, the dimensions are indicated in mm (in) unless otherwise noted.

DN	D	b	K	d	L	approx. kg (lbs)
25	115 (4.53)	16 (0.63)	85 (3.35)	68 (2.68)	4xØ14 (0.55)	1.23 (2.71)
32	140 (5.51)	16 (0.63)	100 (3.94)	78 (3.07)	4xØ18 (0.71)	1.80 (3.97)
40	150 (5.91)	16 (0.63)	110 (4.33)	88 (3.46)	4xØ18 (0.71)	2.09 (4.61)
50	165 (6.50)	18 (0.71)	125 (4.92)	102 (4.02)	4xØ18 (0.71)	2.88 (6.35)
65	185 (7.28)	18 (0.71)	145 (5.71)	122 (4.80)	4xØ18 (0.71)	3.70 (8.16)
80	200 (7.87)	20 (0.79)	160 (6.30)	138 (5.43)	8xØ18 (0.71)	4.83 (10.65)
100	220 (8.66)	20 (0.79)	180 (7.09)	158 (6.22)	8xØ18 (0.71)	5.75 (12.68)
125	250 (9.84)	22 (0.87)	210 (8.27)	188 (7.40)	8xØ18 (0.71)	8.59 (18.94)
150	285 (11.2)	22 (0.87)	240 (9.45)	212 (8.35)	8xØ22 (0.87)	10.6 (23.37)
175	315 (12.4)	24 (0.94)	270 (10.6)	242 (9.53)	8xØ22 (0.87)	14.3 (31.53)
200	340 (13.4)	24 (0.94)	295 (11.6)	268 (10.6)	8xØ22 (0.87)	16.9 (37.26)
250	395 (15.6)	26 (1.02)	350 (13.8)	320 (12.6)	12xØ22 (0.87)	24.7 (54.46)
300	445 (17.5)	26 (1.02)	400 (15.7)	370 (14.6)	12xØ22 (0.87)	31.9 (70.34)

## PN16

DN	D	b	K	d	L	approx. kg (lbs)
25	115 (4.53)	16 (0.63)	85 (3.35)	68 (2.68)	4xØ14 (0.55)	1.23 (2.71)
32	140 (5.51)	16 (0.63)	100 (3.94)	78 (3.07)	4xØ18 (0.71)	1.80 (3.97)
40	150 (5.91)	16 (0.63)	110 (4.33)	88 (3.46)	4xØ18 (0.71)	2.09 (4.61)
50	165 (6.50)	18 (0.71)	125 (4.92)	102 (4.02)	4xØ18 (0.71)	2.88 (6.35)
65	185 (7.28)	18 (0.71)	145 (5.71)	122 (4.80)	4xØ18 (0.71)	3.70 (8.16)
80	200 (7.87)	20 (0.79)	160 (6.30)	138 (5.43)	8xØ18 (0.71)	4.83 (10.65)
100	220 (8.66)	20 (0.79)	180 (7.09)	158 (6.22)	8xØ18 (0.71)	5.75 (12.68)
125	250 (9.84)	22 (0.87)	210 (8.27)	188 (7.40)	8xØ18 (0.71)	8.59 (18.94)
150	285 (11.2)	22 (0.87)	240 (9.45)	212 (8.35)	8xØ22 (0.87)	10.6 (23.37)
175	315 (12.4)	24 (0.94)	270 (10.6)	242 (9.53)	8xØ22 (0.87)	14.3 (31.53)
200	340 (13.4)	24 (0.94)	295 (11.6)	268 (10.6)	12xØ22 (0.87)	16.5 (36.38)
250	405 (15.9)	26 (1.02)	355 (14.0)	320 (12.6)	12xØ26 (1.02)	25.6 (56.45)
300	460 (18.1)	28 (1.10)	410 (16.1)	378 (14.9)	12xØ26 (1.02)	36.1 (79.60)

## PN25

DN	D	b	K	d	L	approx. kg (lbs)
25	115 (4.53)	18 (0.71)	85 (3.35)	68 (2.68)	4xØ14 (0.55)	1.38 (3.04)
32	140 (5.51)	18 (0.71)	100 (3.94)	78 (3.07)	4xØ18 (0.71)	2.03 (4.48)
40	150 (5.91)	18 (0.71)	110 (4.33)	88 (3.46)	4xØ18 (0.71)	2.35 (5.18)
50	165 (6.50)	20 (0.79)	125 (4.92)	102 (4.02)	4xØ18 (0.71)	3.20 (7.06)
65	185 (7.28)	22 (0.87)	145 (5.71)	122 (4.80)	8xØ18 (0.71)	4.33 (9.55)
80	200 (7.87)	24 (0.94)	160 (6.30)	138 (5.43)	8xØ18 (0.71)	5.94 (13.1)
100	235 (9.25)	24 (0.94)	190 (7.48)	162 (6.38)	8xØ22 (0.87)	7.64 (16.85)
125	270 (10.6)	26 (1.02)	220 (8.66)	188 (7.40)	8xØ26 (1.02)	11.0 (24.26)
150	300 (11.8)	28 (1.10)	250 (9.84)	218 (8.58)	8xØ26 (1.02)	14.7 (32.41)
175	330 (13.0)	28 (1.10)	280 (11.0)	248 (9.76)	12xØ26 (1.02)	17.6 (38.81)
200	360 (14.2)	30 (1.18)	310 (12.2)	278 (10.9)	12xØ26 (1.02)	22.7 (50.05)
250	425 (16.7)	32 (1.26)	370 (14.6)	335 (13.2)	12xØ30 (1.18)	34.2 (75.41)
300	485 (19.1)	34 (1.34)	430 (17.0)	395 (15.6)	16xØ30 (1.18)	47.3 (104.3)

PN40

DN	D	b	K	d	L	approx. kg (lbs)
25	115 (4.53)	18 (0.71)	85 (3.35)	68 (2.68)	4xØ14 (0.55)	1.38 (3.04)
32	140 (5.51)	18 (0.71)	100 (3.94)	78 (3.07)	4xØ18 (0.71)	2.03 (4.48)
40	150 (5.91)	18 (0.71)	110 (4.33)	88 (3.46)	4xØ18 (0.71)	2.35 (5.18)
50	165 (6.50)	20 (0.79)	125 (4.92)	102 (4.02)	4xØ18 (0.71)	3.20 (7.06)
65	185 (7.28)	22 (0.87)	145 (5.71)	122 (4.80)	8xØ18 (0.71)	4.33 (9.55)
80	200 (7.87)	24 (0.94)	160 (6.30)	138 (5.43)	8xØ18 (0.71)	5.94 (13.1)
100	235 (9.25)	24 (0.94)	190 (7.48)	162 (6.38)	8xØ22 (0.87)	7.64 (16.85)
125	270 (10.6)	26 (1.02)	220 (8.66)	188 (7.40)	8xØ26 (1.02)	11.0 (24.26)
150	300 (11.8)	28 (1.10)	250 (9.84)	218 (8.58)	8xØ26 (1.02)	14.7 (32.41)
175	350 (13.8)	32 (1.26)	295 (11.6)	260 (10.2)	12xØ30 (1.18)	22.4 (49.39)
200	375 (14.8)	34 (1.34)	320 (12.6)	285 (11.2)	12xØ30 (1.18)	27.6 (60.86)
250	450 (17.7)	38 (1.50)	385 (15.2)	345 (13.6)	12xØ33 (1.30)	44.5 (98.12)
300	515 (20.3)	42 (1.65)	450 (17.7)	410 (16.1)	16xØ33 (1.30)	64.3 (141.8)

PN64

DN	D	b	K	d	L	approx. kg (lbs)
25	140 (5.51)	24 (0.94)	100 (3.94)	68 (2.68)	4xØ18 (0.71)	2.65 (5.84)
32	155 (6.10)	24 (0.94)	110 (4.33)	78 (3.07)	4xØ22 (0.87)	3.24 (7.14)
40	170 (6.69)	26 (1.02)	125 (4.92)	88 (3.46)	4xØ22 (0.87)	4.09 (9.02)
50	180 (7.09)	26 (1.02)	135 (5.31)	102 (4.02)	4xØ22 (0.87)	4.51 (9.94)
65	205 (8.07)	26 (1.02)	160 (6.30)	122 (4.80)	8xØ22 (0.87)	5.71 (12.59)
80	215 (8.46)	28 (1.10)	170 (6.69)	138 (5.43)	8xØ22 (0.87)	6.92 (15.26)
100	250 (9.84)	30 (1.18)	200 (7.87)	162 (6.38)	8xØ26 (1.02)	10.1 (22.27)
125	295 (11.6)	34 (1.34)	240 (9.45)	188 (7.40)	8xØ30 (1.18)	16.0 (35.28)
150	345 (13.6)	36 (1.42)	280 (11.0)	218 (8.58)	8xØ33 (1.30)	23.5 (51.82)
175	375 (14.8)	40 (1.57)	310 (12.2)	260 (10.2)	12xØ33 (1.30)	30.8 (67.91)
200	415 (16.3)	42 (1.65)	345 (13.6)	285 (11.2)	12xØ36 (1.42)	39.7 (87.54)
250	470 (18.5)	46 (1.81)	400 (15.7)	345 (13.6)	12xØ36 (1.42)	57.4 (126.6)
300	530 (20.9)	52 (2.05)	460 (18.1)	410 (16.1)	16xØ36 (1.42)	81.0 (178.6)

## PN100

DN	D	b	K	d	L	approx. kg (lbs)
25	140 (5.51)	24 (0.94)	100 (3.94)	68 (2.68)	4xØ18 (0.71)	2.65 (5.84)
32	155 (6.10)	24 (0.94)	110 (4.33)	78 (3.07)	4xØ22 (0.87)	3.24 (7.14)
40	170 (6.69)	26 (1.02)	125 (4.92)	88 (3.46)	4xØ22 (0.87)	4.09 (9.02)
50	195 (7.68)	28 (1.10)	145 (5.71)	102 (4.02)	4xØ26 (1.02)	5.84 (12.88)
65	220 (8.66)	30 (1.18)	170 (6.69)	122 (4.80)	8xØ26 (1.02)	8.03 (17.71)
80	230 (9.06)	32 (1.26)	180 (7.09)	138 (5.43)	8xØ26 (1.02)	9.43 (20.79)
100	265 (10.4)	36 (1.42)	210 (8.27)	162 (6.38)	8xØ30 (1.18)	14.3 (31.53)
125	315 (12.4)	40 (1.57)	250 (9.84)	188 (7.40)	8xØ33 (1.30)	22.6 (49.83)
150	355 (14.0)	44 (1.73)	290 (11.4)	218 (8.58)	12xØ33 (1.30)	31.8 (70.12)
175	385 (15.2)	48 (1.89)	320 (12.6)	260 (10.2)	12xØ33 (1.30)	41.3 (91.07)
200	430 (16.9)	52 (2.05)	360 (14.2)	285 (11.2)	12xØ36 (1.42)	56.1 (123.7)
250	505 (19.9)	60 (2.36)	430 (16.9)	345 (13.6)	12xØ39 (1.54)	89.6 (197.6)
300	585 (23.0)	68 (2.68)	500 (19.7)	410 (16.1)	16xØ42 (1.65)	119 (262.4)

EN flanges (DIN EN 1092-1)

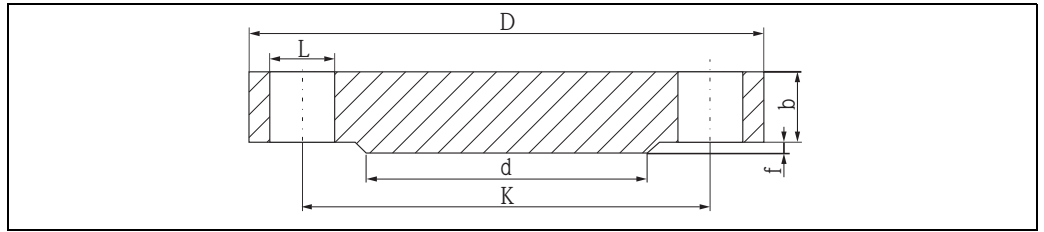

L00-Flangexxx-06-xx-07-xx-002

(Raised face B1)

- L Diameter of holes
- d Raised face diameter
- K Diameter of hole circle
- D Flange diameter
- b Total flange thickness
- f Raised face height (general 2 mm (0.08 in))

PN16

In following tables, the dimensions are indicated in mm (in) unless otherwise noted.

DN	D	b	K	d	L	approx. kg (lbs)
25	115 (4.53)	18 (0.71)	85 (3.35)	68 (2.68)	4xØ14 (0.55)	1.50 (3.31)
32	140 (5.51)	18 (0.71)	100 (3.94)	78 (3.07)	4xØ18 (0.71)	2.00 (4.41)
40	150 (5.91)	18 (0.71)	110 (4.33)	88 (3.46)	4xØ18 (0.71)	2.50 (5.51)
50	165 (6.50)	18 (0.71)	125 (4.92)	102 (4.02)	4xØ18 (0.71)	2.90 (6.39)
65	185 (7.28)	18 (0.71)	145 (5.71)	122 (4.80)	8xØ18 (0.71)	3.50 (7.72)
80	200 (7.87)	20 (0.79)	160 (6.30)	138 (5.43)	8xØ18 (0.71)	4.50 (9.92)
100	220 (8.66)	20 (0.79)	180 (7.09)	158 (6.22)	8xØ18 (0.71)	5.50 (12.13)
125	250 (9.84)	22 (0.87)	210 (8.27)	188 (7.40)	8xØ18 (0.71)	8.00 (17.64)
150	285 (11.2)	22 (0.87)	240 (9.45)	212 (8.35)	8xØ22 (0.87)	10.5 (23.15)
200	340 (13.4)	24 (0.94)	295 (11.6)	268 (10.6)	12xØ22 (0.87)	16.5 (36.38)
250	405 (15.9)	26 (1.02)	355 (14.0)	320 (12.6)	12xØ26 (1.02)	25.0 (55.13)
300	460 (18.1)	28 (1.10)	410 (16.1)	378 (14.9)	12xØ26 (1.02)	35.0 (77.18)

PN25

DN	D	b	K	d	L	approx. kg (lbs)
25	115 (4.53)	18 (0.71)	85 (3.35)	68 (2.68)	4xØ14 (0.55)	1.50 (3.31)
32	140 (5.51)	18 (0.71)	100 (3.94)	78 (3.07)	4xØ18 (0.71)	2.00 (4.41)
40	150 (5.91)	18 (0.71)	110 (4.33)	88 (3.46)	4xØ18 (0.71)	2.50 (5.51)
50	165 (6.50)	20 (0.79)	125 (4.92)	102 (4.02)	4xØ18 (0.71)	3.00 (6.62)
65	185 (7.28)	22 (0.87)	145 (5.71)	122 (4.80)	8xØ18 (0.71)	4.50 (9.92)
80	200 (7.87)	24 (0.94)	160 (6.30)	138 (5.43)	8xØ18 (0.71)	5.50 (12.13)
100	235 (9.25)	24 (0.94)	190 (7.48)	162 (6.38)	8xØ22 (0.87)	7.50 (16.54)
125	270 (10.6)	26 (1.02)	220 (8.66)	188 (7.40)	8xØ26 (1.02)	11.0 (24.26)
150	300 (11.8)	28 (1.10)	250 (9.84)	218 (8.58)	8xØ26 (1.02)	14.5 (31.97)
200	360 (14.2)	30 (1.18)	310 (12.2)	278 (10.9)	12xØ26 (1.02)	22.5 (49.61)
250	425 (16.7)	32 (1.26)	370 (14.6)	335 (13.2)	12xØ30 (1.18)	33.5 (73.9)
300	485 (19.1)	34 (1.34)	430 (16.9)	395 (15.6)	16xØ30 (1.18)	46.5 (102.5)

## PN40

DN	D	b	K	d	L	approx. kg (lbs)
25	115 (4.53)	18 (0.71)	85 (3.35)	68 (2.68)	4xØ14 (0.55)	1.50 (3.31)
32	140 (5.51)	18 (0.71)	100 (3.94)	78 (3.07)	4xØ18 (0.71)	2.00 (4.41)
40	150 (5.91)	18 (0.71)	110 (4.33)	88 (3.46)	4xØ18 (0.71)	2.50 (5.51)
50	165 (6.50)	20 (0.79)	125 (4.92)	102 (4.02)	4xØ18 (0.71)	3.00 (6.62)
65	185 (7.28)	22 (0.87)	145 (5.71)	122 (4.80)	8xØ18 (0.71)	4.50 (9.92)
80	200 (7.87)	24 (0.94)	160 (6.30)	138 (5.43)	8xØ18 (0.71)	5.50 (12.13)
100	235 (9.25)	24 (0.94)	190 (7.48)	162 (6.38)	8xØ22 (0.87)	7.50 (16.54)
125	270 (10.6)	26 (1.02)	220 (8.66)	188 (7.40)	8xØ26 (1.02)	11.0 (24.26)
150	300 (11.8)	28 (1.10)	250 (9.84)	218 (8.58)	8xØ26 (1.02)	14.5 (31.97)
200	375 (14.8)	36 (1.42)	320 (12.6)	285 (11.2)	12xØ30 (1.18)	29.0 (63.95)
250	450 (17.7)	38 (1.50)	385 (15.2)	345 (13.6)	12xØ33 (1.30)	44.5 (98.12)
300	515 (20.3)	42 (1.65)	450 (17.7)	410 (16.1)	16xØ33 (1.30)	64.0 (141.1)

## PN63

DN	D	b	K	d	L	approx. kg (lbs)
25	140 (5.51)	24 (0.94)	100 (3.94)	68 (2.68)	4xØ18 (0.71)	2.50 (5.51)
32	155 (6.10)	24 (0.94)	110 (4.33)	78 (3.07)	4xØ22 (0.87)	3.50 (7.72)
40	170 (6.69)	26 (1.02)	125 (4.92)	88 (3.46)	4xØ22 (0.87)	4.50 (9.92)
50	180 (7.09)	26 (1.02)	135 (5.31)	102 (4.02)	4xØ22 (0.87)	5.00 (11.03)
65	205 (8.07)	26 (1.02)	160 (6.30)	122 (4.80)	8xØ22 (0.87)	6.00 (13.23)
80	215 (8.46)	28 (1.10)	170 (6.69)	138 (5.43)	8xØ22 (0.87)	7.50 (16.54)
100	250 (9.84)	30 (1.18)	200 (7.87)	162 (6.38)	8xØ26 (1.02)	10.5 (23.15)
125	295 (11.6)	34 (1.34)	240 (9.45)	188 (7.40)	8xØ30 (1.18)	16.5 (36.38)
150	345 (13.6)	36 (1.42)	280 (11.0)	218 (8.58)	8xØ33 (1.30)	24.5 (54.02)
200	415 (16.3)	42 (1.65)	345 (13.6)	285 (11.2)	12xØ36 (1.42)	40.5 (89.3)
250	470 (18.5)	46 (1.81)	400 (15.7)	345 (13.6)	12xØ36 (1.42)	58.0 (127.9)
300	530 (20.9)	52 (2.05)	460 (18.1)	410 (16.1)	16xØ36 (1.42)	83.5 (184.1)

**PN100**

DN	D	b	K	d	L	approx. kg (lbs)
25	140 (5.51)	24 (0.94)	100 (3.94)	68 (2.68)	4xØ18 (0.71)	2.50 (5.51)
32	155 (6.10)	24 (0.94)	110 (4.33)	78 (3.07)	4xØ22 (0.87)	3.50 (7.72)
40	170 (6.69)	26 (1.02)	125 (4.92)	88 (3.46)	4xØ22 (0.87)	4.50 (9.92)
50	195 (7.68)	28 (1.10)	145 (5.71)	102 (4.02)	4xØ26 (1.02)	6.00 (13.23)
65	220 (8.66)	30 (1.18)	170 (6.69)	122 (4.80)	8xØ26 (1.02)	8.00 (17.64)
80	230 (9.06)	32 (1.26)	180 (7.09)	138 (5.43)	8xØ26 (1.02)	9.50 (20.95)
100	265 (10.4)	36 (1.42)	210 (8.27)	162 (6.38)	8xØ30 (1.18)	14.0 (30.87)
125	315 (12.4)	40 (1.57)	250 (9.84)	188 (7.40)	8xØ33 (1.30)	22.5 (49.61)
150	355 (14.0)	44 (1.73)	290 (11.4)	218 (8.58)	12xØ33 (1.30)	30.5 (67.25)
200	430 (16.9)	52 (2.05)	360 (14.2)	285 (11.2)	12xØ36 (1.42)	54.5 (120.2)
250	505 (19.9)	60 (2.36)	430 (16.9)	345 (13.6)	12xØ39 (1.54)	87.5 (192.9)
300	585 (23.0)	68 (2.68)	500 (19.7)	410 (16.1)	16xØ42 (1.65)	131.5 (289.9)

## ASME-Flange (ASME B16.5 - 2013)

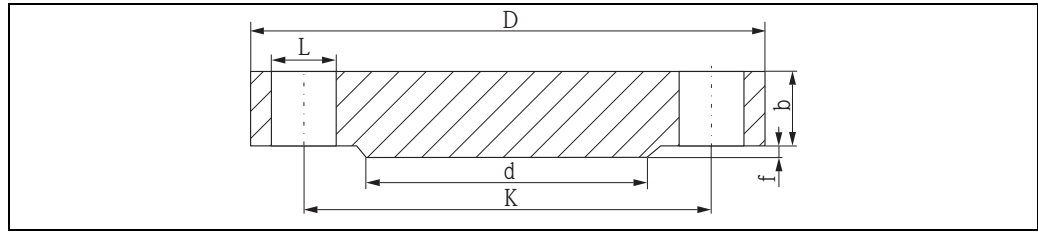

(Raised face RF)

- L* Diameter of holes  
*d* Raised face diameter  
*K* Diameter of hole circle  
*D* Flange diameter  
*b* Total flange thickness  
*f* Raised face height Class 150/300: 1.6 mm (0.06 in) or  
 from Class 600: 6.4 mm (0.25 in)

Note!

Surface finish of the gasket faces  $Ra \leq 3.2$  to  $6.3 \mu\text{m}$  (126 to 248  $\mu\text{in}$ ).

## Class 150

In following tables, the dimensions are indicated in mm (in) unless otherwise noted.

NPS (Nominal pipe size)	D	b	K	d	L	approx. kg (lbs)
1"	108.0 (4.25)	14.2 (0.56)	79.2 (3.12)	50.8 (2.00)	4x $\varnothing$ 15.7 (0.62)	0.86 (1.9)
1¼"	117.3 (4.62)	15.7 (0.62)	88.9 (3.50)	63.5 (2.50)	4x $\varnothing$ 15.7 (0.62)	1.17 (2.58)
1½"	127.0 (5.00)	17.5 (0.69)	98.6 (3.88)	73.2 (2.88)	4x $\varnothing$ 15.7 (0.62)	1.53 (3.37)
2"	152.4 (6.00)	19.1 (0.75)	120.7 (4.75)	91.9 (3.62)	4x $\varnothing$ 19.1 (0.75)	2.42 (5.34)
2½"	177.8 (7.00)	22.4 (0.88)	139.7 (5.50)	104.6 (4.12)	4x $\varnothing$ 19.1 (0.75)	3.94 (8.69)
3"	190.5 (7.50)	23.9 (0.94)	152.4 (6.00)	127.0 (5.00)	4x $\varnothing$ 19.1 (0.75)	4.93 (10.87)
3½"	215.9 (8.50)	23.9 (0.94)	177.8 (7.00)	139.7 (5.50)	8x $\varnothing$ 19.1 (0.75)	6.17 (13.60)
4"	228.6 (9.00)	23.9 (0.94)	190.5 (7.50)	157.2 (6.19)	8x $\varnothing$ 19.1 (0.75)	7.00 (15.44)
5"	254.0 (10.0)	23.9 (0.94)	215.9 (8.50)	185.7 (7.31)	8x $\varnothing$ 22.4 (0.88)	8.63 (19.03)
6"	279.4 (11.0)	25.4 (1.00)	241.3 (9.50)	215.9 (8.50)	8x $\varnothing$ 22.4 (0.88)	11.3 (24.92)
8"	342.9 (13.5)	28.4 (1.12)	298.5 (11.8)	269.7 (10.6)	8x $\varnothing$ 22.4 (0.88)	19.6 (43.22)
10"	406.4 (16.0)	30.2 (1.19)	362.0 (14.3)	323.8 (12.7)	12x $\varnothing$ 25.4 (1.00)	28.8 (63.50)



**Class 300**

NPS (Nominal pipe size)	D	b	K	d	L	approx. kg (lbs)
1"	124.0 (4.88)	17.5 (0.69)	88.9 (3.50)	50.8 (2.00)	4xØ19.1 (0.75)	1.39 (3.06)
1¼"	133.4 (5.25)	19.1 (0.75)	98.6 (3.88)	63.5 (2.50)	4xØ19.1 (0.75)	1.79 (3.95)
1½"	155.4 (6.12)	20.6 (0.81)	114.3 (4.50)	73.2 (2.88)	4xØ22.4 (0.88)	2.66 (5.87)
2"	165.1 (6.50)	22.4 (0.88)	127.0 (5.00)	91.9 (3.62)	8xØ19.1 (0.75)	3.18 (7.01)
2½"	190.5 (7.50)	25.4 (1.00)	149.4 (5.88)	104.6 (4.12)	8xØ22.4 (0.88)	4.85 (10.69)
3"	209.5 (8.25)	28.4 (1.12)	168.1 (6.62)	127.0 (5.00)	8xØ22.4 (0.88)	6.81 (15.02)
3½"	228.6 (9.00)	30.2 (1.19)	184.2 (7.25)	139.7 (5.50)	8xØ22.4 (0.88)	8.71 (19.21)
4"	254.0 (10.0)	31.8 (1.25)	200.2 (7.88)	157.2 (6.19)	8xØ22.4 (0.88)	11.5 (25.36)
5"	279.4 (11.0)	35.1 (1.38)	235.0 (9.25)	185.7 (7.31)	8xØ22.4 (0.88)	15.6 (34.4)
6"	317.5 (12.5)	36.6 (1.44)	269.7 (10.6)	215.9 (8.50)	12xØ22.4 (0.88)	20.9 (46.08)
8"	381.0 (15.0)	41.1 (1.62)	330.2 (13.0)	269.7 (10.6)	12xØ25.4 (1.00)	34.3 (75.63)
10"	444.5 (17.5)	47.8 (1.88)	387.4 (15.3)	323.8 (12.7)	16xØ28.4 (1.12)	53.3 (117.5)

**Class 600**

NPS (Nominal pipe size)	D	b	K	d	L	approx. kg (lbs)
1"	124.0 (4.88)	17.5 (0.69)	88.9 (3.50)	50.8 (2.00)	4xØ19.1 (0.75)	1.60 (3.53)
1¼"	133.4 (5.25)	20.6 (0.81)	98.6 (3.88)	63.5 (2.50)	4xØ19.1 (0.75)	2.23 (4.92)
1½"	155.4 (6.12)	22.4 (0.88)	114.3 (4.50)	73.2 (2.88)	4xØ22.4 (0.88)	3.25 (7.17)
2"	165.1 (6.50)	25.4 (1.00)	127.0 (5.00)	91.9 (3.62)	8xØ19.1 (0.75)	4.15 (9.15)
2½"	190.5 (7.50)	28.4 (1.12)	149.4 (5.88)	104.6 (4.12)	8xØ22.4 (0.88)	6.13 (13.52)
3"	209.5 (8.25)	31.8 (1.25)	168.1 (6.62)	127.0 (5.00)	8xØ22.4 (0.88)	8.44 (18.61)
3½"	228.6 (9.00)	35.1 (1.38)	184.2 (7.25)	139.7 (5.50)	8xØ25.4 (1.00)	11.0 (24.26)
4"	273.1 (10.8)	38.1 (1.50)	215.9 (8.50)	157.2 (6.19)	8xØ25.4 (1.00)	17.3 (38.15)
5"	330.2 (13.0)	44.5 (1.75)	266.7 (10.5)	185.7 (7.31)	8xØ28.4 (1.12)	29.4 (64.83)
6"	355.6 (14.0)	47.8 (1.88)	292.1 (11.5)	215.9 (8.50)	12xØ28.4 (1.12)	36.1 (79.6)
8"	419.1 (16.5)	55.6 (2.19)	349.3 (13.8)	269.7 (10.6)	12xØ31.8 (1.25)	58.9 (129.9)
10"	508.0 (20.0)	63.5 (2.50)	431.8 (17.0)	323.8 (12.7)	16xØ35.1 (1.38)	97.5 (214.9)

## Class 900

NPS (Nominal pipe size)	D	b	K	d	L	approx. kg (lbs)
1"	149.4 (5.88)	28.4 (1.12)	101.6 (4.00)	50.8 (2.00)	4xØ25.4 (1.00)	3.57 (7.87)
1¼"	158.8 (6.25)	28.4 (1.12)	111.3 (4.38)	63.5 (2.50)	4xØ25.4 (1.00)	4.14 (9.13)
1½"	177.8 (7.00)	31.8 (1.25)	124.0 (4.88)	73.2 (2.88)	4xØ28.4 (1.12)	5.75 (12.68)
2"	215.9 (8.50)	38.1 (1.50)	165.1 (6.50)	91.9 (3.62)	8xØ25.4 (1.00)	10.1 (22.27)
2½"	244.4 (9.62)	41.1 (1.62)	190.5 (7.50)	104.6 (4.12)	8xØ28.4 (1.12)	14.0 (30.87)
3"	241.3 (9.50)	38.1 (1.50)	190.5 (7.50)	127.0 (5.00)	8xØ25.4 (1.00)	13.1 (28.89)
4"	292.1 (11.50)	44.5 (1.75)	235.0 (9.25)	157.2 (6.19)	8xØ31.8 (1.25)	26.9 (59.31)
5"	349.3 (13.8)	50.8 (2.00)	279.4 (11.0)	185.7 (7.31)	8xØ35.1 (1.38)	36.5 (80.48)
6"	381.0 (15.00)	55.6 (2.19)	317.5 (12.5)	215.9 (8.50)	12xØ31.8 (1.25)	47.4 (104.5)
8"	469.9 (18.50)	63.5 (2.50)	393.7 (15.5)	269.7 (10.6)	12xØ38.1 (1.50)	82.5 (181.9)
10"	546.1 (21.50)	69.9 (2.75)	469.9 (18.5)	323.8 (12.7)	16xØ38.1 (1.50)	122 (269.0)

## Class 1500

NPS (Nominal pipe size)	D	b	K	d	L	approx. kg (lbs)
1"	149.4 (5.88)	28.4 (1.12)	101.6 (4.00)	50.8 (2.00)	4xØ25.4 (1.00)	3.57 (7.87)
1¼"	158.8 (6.25)	28.4 (1.12)	111.3 (4.38)	63.5 (2.50)	4xØ25.4 (1.00)	4.14 (9.13)
1½"	177.8 (7.00)	31.8 (1.25)	124.0 (4.88)	73.2 (2.88)	4xØ28.4 (1.12)	5.75 (12.68)
2"	215.9 (8.50)	38.1 (1.50)	165.1 (6.50)	91.9 (3.62)	8xØ25.4 (1.00)	10.1 (22.27)
2½"	244.4 (9.62)	41.1 (1.62)	190.5 (7.50)	104.6 (4.12)	8xØ28.4 (1.12)	14.0 (30.87)
3"	266.7 (10.50)	47.8 (1.88)	203.2 (8.00)	127.0 (5.00)	8xØ31.8 (1.25)	19.1 (42.12)
4"	311.2 (12.3)	53.8 (2.12)	241.3 (9.50)	157.2 (6.19)	8xØ35.1 (1.38)	29.9 (65.93)
5"	374.7 (14.8)	73.2 (2.88)	292.1 (11.5)	185.7 (7.31)	8xØ41.1 (1.62)	58.4 (128.8)
6"	393.7 (15.50)	82.6 (3.25)	317.5 (12.5)	215.9 (8.50)	12xØ38.1 (1.50)	71.8 (158.3)
8"	482.6 (19.00)	91.9 (3.62)	393.7 (15.5)	269.7 (10.6)	12xØ44.5 (1.75)	122 (269.0)
10"	584.2 (23.00)	108.0 (4.25)	482.6 (19.0)	323.8 (12.7)	12xØ50.8 (2.00)	210 (463.0)

JIS flanges (B 2220)

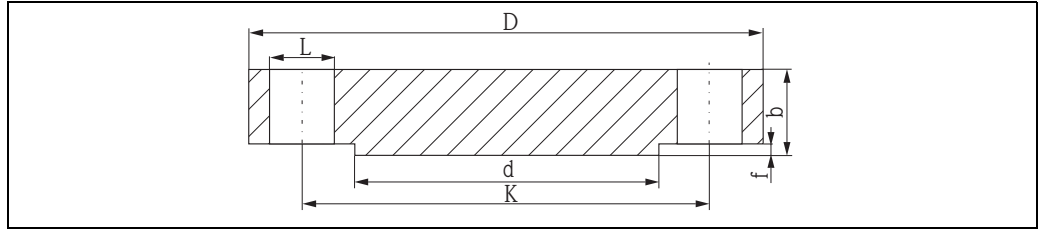

L00-Flangexxx-06-xx-07-xx-001

(Raised face RF)

- L Diameter of holes
- d Raised face diameter
- K Diameter of hole circle
- D Flange diameter
- b Total flange thickness
- f Raised face height (general 2 mm (0.08 in))

Note!

Surface finish of the gasket faces  $Ra \leq 3.2$  to  $6.3 \mu\text{m}$  (126 to 248  $\mu\text{in}$ ).

10 K

In following tables, the dimensions are indicated in mm (in) unless otherwise noted.

DN	D	b	K	d	L
25	125 (4.92)	14 (0.55)	90 (3.54)	67 (2.64)	4xØ19 (0.75)
32	135 (5.31)	16 (0.63)	100 (3.94)	76 (2.99)	4xØ19 (0.75)
40	140 (5.51)	16 (0.63)	105 (4.13)	81 (3.19)	4xØ19 (0.75)
50	155 (6.10)	16 (0.63)	120 (4.72)	96 (3.78)	4xØ19 (0.75)
65	175 (6.89)	18 (0.71)	140 (5.51)	116 (4.57)	4xØ19 (0.75)
80	185 (7.28)	18 (0.71)	150 (5.91)	126 (4.96)	8xØ19 (0.75)
100	210 (8.27)	18 (0.71)	175 (6.89)	151 (5.94)	8xØ19 (0.75)
125	250 (9.84)	20 (0.79)	210 (8.27)	182 (7.17)	8xØ23 (0.91)
150	280 (11.0)	22 (0.87)	240 (9.45)	212 (8.35)	8xØ23 (0.91)
200	330 (13.0)	22 (0.87)	290 (11.4)	262 (10.3)	12xØ23 (0.91)
250	400 (15.7)	24 (0.94)	355 (14.0)	324 (12.8)	12xØ25 (0.98)
300	445 (17.5)	24 (0.94)	400 (15.7)	368 (14.5)	16xØ25 (0.98)

20 K

DN	D	b	K	d	L
25	125 (4.92)	16 (0.63)	90 (3.54)	67 (2.64)	4xØ19 (0.75)
32	135 (5.31)	18 (0.71)	100 (3.94)	76 (2.99)	4xØ19 (0.75)
40	140 (5.51)	18 (0.71)	105 (4.13)	81 (3.19)	4xØ19 (0.75)
50	155 (6.10)	18 (0.71)	120 (4.72)	96 (3.78)	8xØ19 (0.75)
65	175 (6.89)	20 (0.79)	140 (5.51)	116 (4.57)	8xØ19 (0.75)
80	200 (7.87)	22 (0.87)	160 (6.30)	132 (5.20)	8xØ23 (0.91)
100	225 (8.86)	24 (0.94)	185 (7.28)	160 (6.30)	8xØ23 (0.91)
125	270 (10.6)	26 (1.02)	225 (8.86)	195 (7.68)	8xØ25 (0.98)
150	305 (12.0)	28 (1.10)	260 (10.2)	230 (9.06)	12xØ25 (0.98)
200	350 (13.8)	30 (1.18)	305 (12.0)	275 (10.8)	12xØ25 (0.98)
250	430 (16.9)	34 (1.34)	380 (15.0)	345 (13.6)	12xØ27 (1.06)
300	480 (18.9)	36 (1.42)	430 (16.9)	395 (15.6)	16xØ27 (1.06)

63 K

DN	D	b	K	d	L
25	140 (5.51)	27 (1.06)	100 (3.94)	70 (2.76)	4xØ23 (0.91)
32	150 (5.91)	30 (1.18)	110 (4.33)	80 (3.15)	4xØ23 (0.91)
40	175 (6.89)	32 (1.26)	130 (5.12)	90 (3.54)	4xØ25 (0.98)
50	185 (7.28)	34 (1.34)	145 (5.71)	105 (4.13)	8xØ23 (0.91)
65	220 (8.66)	38 (1.50)	175 (6.89)	130 (5.12)	8xØ25 (0.98)
80	230 (9.06)	40 (1.57)	185 (7.28)	140 (5.51)	8xØ25 (0.98)
100	270 (10.6)	44 (1.73)	220 (8.66)	165 (6.50)	8xØ27 (1.06)
125	325 (12.8)	50 (1.97)	265 (10.4)	200 (7.87)	8xØ33 (1.30)
150	365 (14.4)	54 (2.13)	305 (12.0)	240 (9.45)	12xØ33 (1.30)
200	425 (16.7)	60 (2.36)	360 (14.2)	290 (11.4)	12xØ33 (1.30)
250	500 (19.7)	68 (2.68)	430 (16.9)	355 (14.0)	12xØ39 (1.54)
300	560 (22.0)	77 (3.03)	485 (19.1)	410 (16.1)	16xØ39 (1.54)

## Adapter flange FAU70

An adapter flange makes it possible to use devices with a threaded connection.

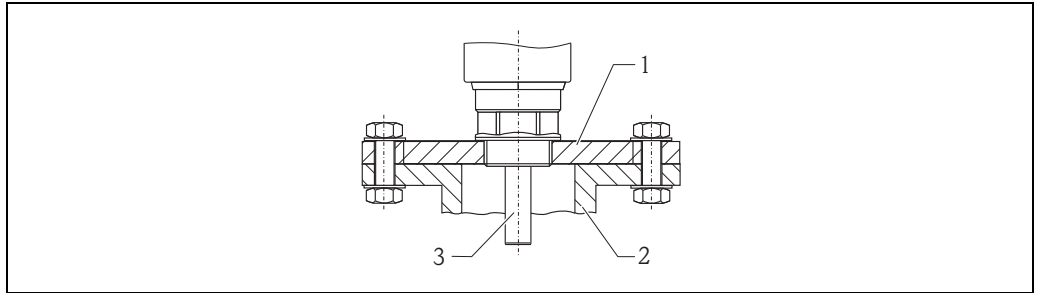

L00-flangexxx-00-00-00-xx-001

- 1 Adapter flange
- 2 Nozzle
- 3 Probe

### FAU70E Version with metrical thread

#### Order information

010	Process Connection	
12	DN 50 PN16 A, flange EN 1092-1 (DIN 2527 B)	
14	DN 80 PN16 A, flange EN 1092-1 (DIN 2527 B)	
15	DN 100 PN16 A, flange EN 1092-1 (DIN 2527 B)	
99	Special version, to be specified	
020	Sensor Connection	
3	Thread ISO228 G1-1/2	
4	Thread ISO228 G2	
99	Special version, to be specified	
030	Flange Material	
2	316L	
3	Steel	
7	Polypropylene	
99	Special version, to be specified	

The versions entered make up the order code:

	010	020	030
FAU70E -			

### FAU70A Version with conical thread

010	Process Connection	
22	2" 150 lbs FF, flange ANSI B16.5	
24	3" 150 lbs FF, flange ANSI B16.5	
25	4" 150 lbs FF, flange ANSI B16.5	
99	Special version, to be specified	
020	Sensor Connection	
5	Thread NPT1-1/2	
6	Thread NPT2	
99	Special version, to be specified	
030	Flange Material	
2	316L	
3	Steel	
7	Polypropylene	
99	Special version, to be specified	

The versions entered make up the order code:

	010	020	030
FAU70A -			

## Slip-on flange FAU80

The sensors (FDU91F, FDU80F, FDU81F) can be flush mounted using a FAU80 slip-on flange. Flanges in polypropylene (PP) should only be used with pressures up to 1.5 bar<sub>abs</sub> (22 psi) flanges in 316L also above.

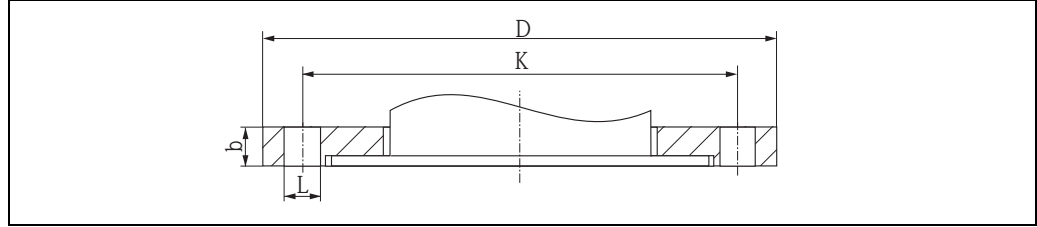

L00-flangexxx-xx-00-00-xx-000

Details to dimension "Mechanical Construction" → [33](#)

### FAU80 Version slip-on flange Order information

010	Process Connection	
AA	3" 150 lbs FF, flange ANSI B16.5	
AH	4" 150 lbs FF, flange ANSI B16.5	
CA	DN 80 PN16 A, flange EN1092-1 (DIN2527 B)	
CH	DN 100 PN16 A, flange EN1092-1 (DIN2527 B)	
KA	10K 80A FF, flange JIS B2220	
KH	10K 100A FF, flange JIS B2220	
YY	Special version, to be specified	
020	Flange Material	
J	316L	
P	PPs, max. 1.5 bar abs	
Y	Special version, to be specified	

The versions entered make up the order code:

	010	020
FAU80 -		

## Screw in flange FAX50

The screw in flange is an universal flange. On the basis of dimensions min./max. it can be used for all three standards (DIN - ASME - JIS).

### FAX50 universal flange DIN-ASME-JIS

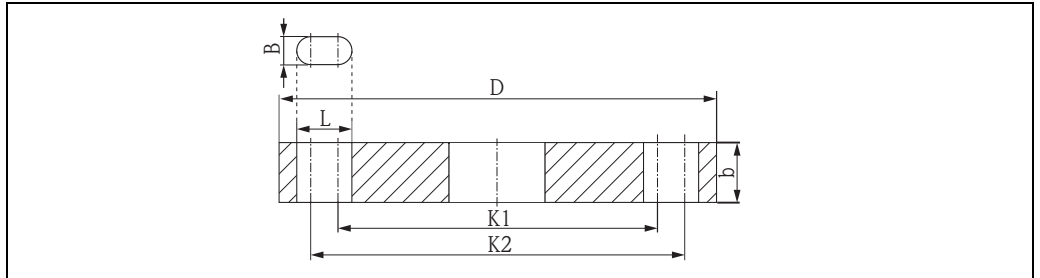

L00-Flangexxx-xx-00-00-xx-000

- L Diameter of holes
- K1, K2 Diameter of hole circle
- D Flange diameter
- b Total flange thickness
- B Slotted hole (width)

### G 3/4", NPT 3/4"

In following tables, the dimensions are indicated in mm (in) unless otherwise noted.

DN	D	b	L	K1	K2	approx. kg (lbs)		
						PP	PVDF	316L
50	165 (6.50)	20 (0.79)	4xØ19 (0.75)	120 (4.72)	125 (4.92)	-	-	3.11 (6.86)
80	200 (7.87)		8xØ19 (0.75)	150 (5.91)	160 (6.30)	-	-	4.37 (9.64)
100	228.6 (9.0)		8xØ19 (0.75)	175 (6.89)	190.5 (7.5)	-	-	5.79 (12.77)

### G 1", NPT 1"

DN	D	b	L	K1	K2	approx. kg (lbs)		
						PP	PVDF	316L
80	200 (7.87)	20 (0.79)	8xØ19 (0.75)	150 (5.91)	160 (6.30)	0.50 (1.10)	0.97 (2.14)	4.34 (9.57)
100	228.6 (9.0)		8xØ19 (0.75)	175 (6.89)	190.5 (7.5)	0.66 (1.46)	1.29 (2.84)	5.75 (12.68)
150	285 (11.2)		8xØ23 (0.91)	240 (9.45)	241.3 (9.5)	1.09 (2.40)	2.12 (4.67)	9.44 (20.82)
200 <sup>1)</sup>	340 (13.4)		12xØ23 (0.91)	290 (11.4)	295 (11.6)	1.53 (3.37)	-	-
250	406.4 (16.0)		12xØ26 (1.02)	355 (14.0)	362 (14.3)	2.20 (4.85)	-	-

1) Only for DIN und JIS!

### Exception G 1"

NPS (Nominal pipe size)	D	b	L	K1	K2	approx. kg (lbs)		
						PP	PVDF	316L
8"	342.9 (13.5)	20 (0.79)	8xØ22.5 (0.89)	298.5 (11.8)	298.5 (11.8)	1.61 (3.55)	-	-

## G 1½", NPT 1½"

DN	D	b	L	K1	K2	approx. kg (lbs)		
						PP	PVDF	316L
50	165 (6.50)	20 (0.79)	4xØ19 (0.75)	120 (4.72)	125 (4.92)	0.34 (0.75)	0.67 (1.48)	2.97 (6.55)
80	200 (7.87)		8xØ19 (0.75)	150 (5.91)	160 (6.30)	0.49 (1.08)	0.95 (2.09)	4.24 (9.35)
100	228.6 (9.0)		8xØ19 (0.75)	175 (6.89)	190.5 (7.5)	0.65 (1.43)	1.27 (2.80)	5.65 (12.46)
150	285 (11.2)		8xØ23 (0.91)	240 (9.45)	241.3 (9.5)	1.08 (2.38)	2.09 (4.61)	9.34 (20.59)

## G 2", NPT 2"

DN	D	b	L	K1	K2	approx. kg (lbs)		
						PP	PVDF	316L
50	165 (6.50)	20 (0.79)	4xØ19 (0.75)	120 (4.72)	125 (4.92)	0.33 (0.73)	0.63 (1.39)	2.83 (6.24)
80	200 (7.87)		8xØ19 (0.75)	150 (5.91)	160 (6.30)	0.47 (1.04)	0.92 (2.03)	4.10 (9.04)
100	228.6 (9.0)		8xØ19 (0.75)	175 (6.89)	190.5 (7.5)	0.64 (1.41)	1.24 (2.73)	5.51 (12.15)
150	285 (11.2)		8xØ23 (0.91)	240 (9.45)	241.3 (9.5)	1.06 (2.34)	2.06 (4.54)	9.20 (20.29)



**Order information FAX50**

015		Material:
BR1	DN50 PN10/16 A, steel flange EN1092-1	
BS1	DN80 PN10/16 A, steel flange EN1092-1	
BT1	DN100 PN10/16 A, steel flange EN1092-1	
JF1	2" 150lbs FF, steel flange ANSI B16.5	
JG1	3" 150lbs FF, steel flange ANSI B16.5	
JH1	4" 150lbs FF, steel flange ANSI B16.5	
JK2	8" 150lbs FF, PP max 3 bar abs/44 psia flange ANSI B16.5	
XIF	UNI flange 2"/DN50/50, PVDF max 4 bar abs/58 psia, suitable for 2" 150 lbs/DN50 PN16/10K 50	
XIG	UNI flange 2"/DN50/50, PP max 4 bar abs/58 psia, suitable for 2" 150 lbs/DN50 PN16/10K 50	
XIJ	UNI flange 2"/DN50/50, 316L max 4 bar abs/58 psia, suitable for 2" 150 lbs/DN50 PN16/10K 50	
XJF	UNI flange 3"/DN80/80, PVDF max 4 bar abs/58 psia, suitable for 3" 150 lbs/DN80 PN16/10K 80	
XJG	UNI flange 3"/DN80/80, PP max 4 bar abs/58 psia, suitable for 3" 150 lbs/DN80 PN16/10K 80	
XJJ	UNI flange 3"/DN80/80, 316L max 4 bar abs/58 psia, suitable for 3" 150 lbs/DN80 PN16/10K 80	
XKF	UNI flange 4"/DN100/100, PVDF max 4 bar abs/58 psia, suitable for 4" 150 lbs/DN100 PN16/10K 100	
XKG	UNI flange 4"/DN100/100, PP max 4 bar abs/58 psia, suitable for 4" 150 lbs/DN100 PN16/10K 100	
XKJ	UNI flange 4"/DN100/100, 316L max 4 bar abs/58 psia, suitable for 4" 150 lbs/DN100 PN16/10K 100	
XLF	UNI flange 6"/DN150/150, PVDF max 4 bar abs/58 psia, suitable for 6" 150 lbs/DN150 PN16/10K 150	
XLG	UNI flange 6"/DN150/150, PP max 4 bar abs/58 psia, suitable for 6" 150 lbs/DN150 PN16/10K 150	
XLJ	UNI flange 6"/DN150/150, 316L max 4 bar abs/58 psia, suitable for 6" 150 lbs/DN150 PN16/10K 150	
XMG	UNI flange DN200/200, PP max 4 bar abs/58 psia, suitable for DN200 PN16/10K 200	
XNG	UNI flange DN250/250, PP max 4 bar abs/58 psia, suitable for DN250 PN16/10K 250	
YYY	Special version	

020		Sensor Connection:
A	Thread ISO228 G3/4	
B	Thread ISO228 G1	
C	Thread ISO228 G1-1/2	
D	Thread ISO228 G2	
E	Thread ANSI NPT3/4	
F	Thread ANSI NPT1	
G	Thread ANSI NPT1-1/2	
H	Thread ANSI NPT2	
Y	Special version	

The versions entered make up the order code:

	15	20
FAX50 -		

## Pressure-temperature dependencies

### EN flanges<sup>1)</sup>

Temperature range	Nominal pressure (data in bar (psi))				
	PN16	PN25	PN40	PN63	PN100
-10 °C ... +50 °C (+14 °F ... +122 °F)	16.0 (232)	25.0 (362)	40.0 (580)	63.0 (913)	100.0 (1450)
50 °C (122 °F)	15.5 (225)	24.3 (352)	38.9 (564)	61.3 (889)	97.3 (1411)
100 °C (212 °F)	15.1 (219)	23.6 (342)	37.9 (550)	59.7 (866)	94.7 (1373)
150 °C (302 °F)	13.7 (199)	21.5 (312)	34.4 (499)	54.3 (787)	86.1 (1248)
200 °C (392 °F)	12.7 (184)	19.8 (287)	31.8 (461)	50.1 (726)	79.5 (1153)
250 °C (482 °F)	11.9 (173)	18.6 (270)	29.9 (434)	47.1 (683)	74.7 (1083)
300 °C (572 °F)	11.0 (159)	17.2 (249)	27.6 (400)	43.5 (631)	69.0 (1000)
350 °C (662 °F)	10.5 (152)	16.5 (239)	26.4 (383)	41.7 (605)	66.1 (958)
400 °C (752 °F)	10.2 (148)	16.0 (232)	25.7 (373)	40.1 (580)	64.2 (931)

### ASME flanges<sup>1)</sup>

Temperature range	Nominal pressure (data in bar (psi))				
	Class 150	Class 300	Class 600	Class 900	Class 1500
-29 °C ... +38 °C (-20 °F ... +100 °F)	19.0 (275)	49.6 (719)	99.3 (1440)	148.9 (2159)	248.2 (3599)
50 °C (122 °F)	18.4 (267)	48.1 (697)	96.2 (1395)	144.3 (2092)	240.6 (3489)
100 °C (212 °F)	16.2 (235)	42.2 (612)	84.4 (1224)	126.6 (1836)	211.0 (3059)
150 °C (302 °F)	14.8 (215)	38.5 (558)	77.0 (1116)	115.5 (1675)	192.5 (2791)
200 °C (392 °F)	13.7 (199)	35.7 (518)	71.3 (1034)	107.0 (1551)	178.3 (2588)
250 °C (482 °F)	12.1 (175)	33.4 (484)	66.8 (969)	100.1 (1451)	166.9 (2420)
300 °C (572 °F)	10.2 (148)	31.6 (458)	63.2 (916)	94.9 (1376)	158.1 (2292)
325 °C (617 °F)	9.3 (135)	30.9 (448)	61.8 (896)	92.7 (1344)	154.4 (2239)
350 °C (662 °F)	8.4 (122)	30.3 (439)	60.7 (880)	91.0 (1319)	151.6 (2189)
375 °C (707 °F)	7.4 (107)	29.9 (434)	59.8 (867)	89.6 (1299)	149.4 (2166)
400 °C (752 °F)	6.5 (94)	29.4 (426)	58.9 (854)	88.3 (1280)	147.2 (2134)

### JIS flanges<sup>1)</sup>

Temperature range	Nominal pressure (data in bar (psi))			
	10 K	20 K		
	for all flanges	to DN 125	from DN 150 up to DN 250	DN 300
up to 120 °C (248 °F)	14 (203.0)	34 (493.0)	20 (290.0)	20 (290.0)
220 °C (428 °F)	12 (174.0)	31 (449.5)	20 (290.0)	-
300 °C (572 °F)	10 (145.0)	29 (420.5)	19 (275.5)	-
350 °C (662 °F)	-	26 (377.0)	17 (246.5)	-
400 °C (752 °F)	-	23 (333.5)	17 (246.5)	-
425 °C (797 °F)	-	20 (290.0)	17 (246.5)	-

1) With regard to their stability-temperature property, the materials 1.4435 and 1.4404 are grouped in DIN EN 1092-1 table 18 under 13EO and in JIS B2220:2004 table 5 under O23b. The ASME flanges are dual rated flanges (316/316L) and grouped in table 2-2.2 according to ASME B16.5-2013.





[www.addresses.endress.com](http://www.addresses.endress.com)

---